

C O N T E N T S

Fuji Air Tools *BEST OF THE BEST* 2

Your Guide to Our Catalogue 4

Assembly Tools

Controllers / Testers
Electronic Torque Control Pulse Wrenches
Pulse Wrenches Shut-off Type
Pulse Wrenches
Impact Wrenches
Screw Drivers
Open-end Wrenches
Ratchet Wrenches
Accessories

Abrasive Tools

Pencil Grinder
Turbo Grinders
Die Grinders
Low Speed Grinders
Straight Grinders
Extended Grinders
Angle Grinders
Angle Sanders
Angle Cutters
Disc Sander
Vertical Grinders
Belt Sanders
Orbital Sanders
Accessories

Drills/Tappers

Drills
Baby Angle Drills
Corner Drills
Accessories
Tappers

Percussive Tools

Flux Chippers
Light Hammers
Chipping & Calking Hammers
Riveting Hammers
Concrete Breakers
Needle Scalars
Scaling Hammers
Sand Rammers
Accessories

Air Motors

Air Motors
Air Starters

Others

Pipe Beveling Machines
Automatic Seal Welders
Welding Wire Rewinder / Tube Expanders
Tip Dressers
Chamfering Machines
Aluminum Milling Machines
Air Files / Air Saws
Sump Pumps
Piston Pumps
Marking Pen
Deburring Tools
Air Line Heaters
Air Cleaners
Air Hoists
Air Winches

Air Line Accessories/Spanners and Wrenches for

Air Line Accessories
Spanners and Wrenches for Maintenance
Air Tools and Air Compressor
Air Tools and Air Pressure

Dimensions

Assembly Tools
Abrasive Tools
Drills/Tappers
Percussive Tools
Air Motors
Others

INDEX

141

41

69

79

89

95

119

Fuji Air Tools

BEST OF THE BEST

Fuji, with Utmost Passion for ECO-QUALITY

UNIQUE ENGINEERING POWER
SUPPORTS PRODUCTION
OF HIGH QUALITY PRODUCTS.

We believe "Quality is a perpetual and absolute factor" in order to develop and deliver quality products. All products are subject to our strict design and development criteria and the production control system throughout the manufacturing process, from the selection of material to the final inspection of the finished products prior to shipment. We also believe that the superb reputation and reliance among customers on Fuji products are delivered from the non-compromising attitude towards the quality we provide. We are completely sure that we will be able to keep offering continued customer satisfaction with our unchanging attitude in toward the quality of our products.

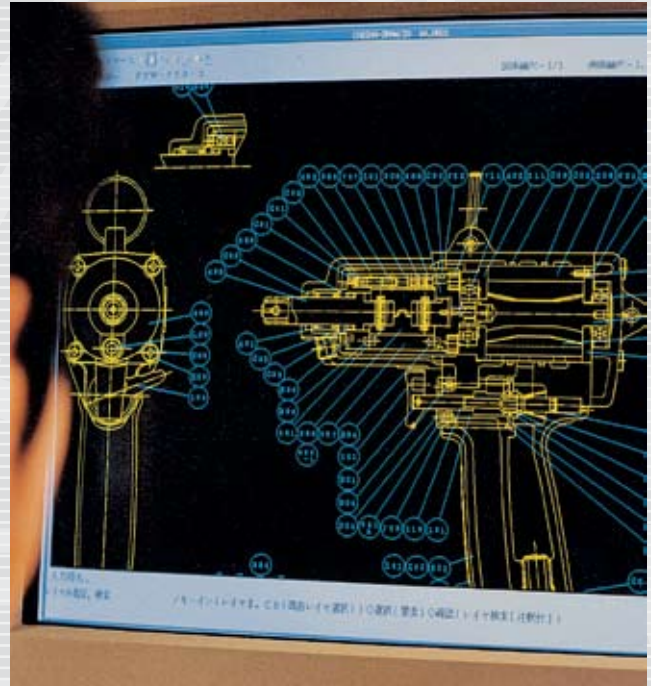
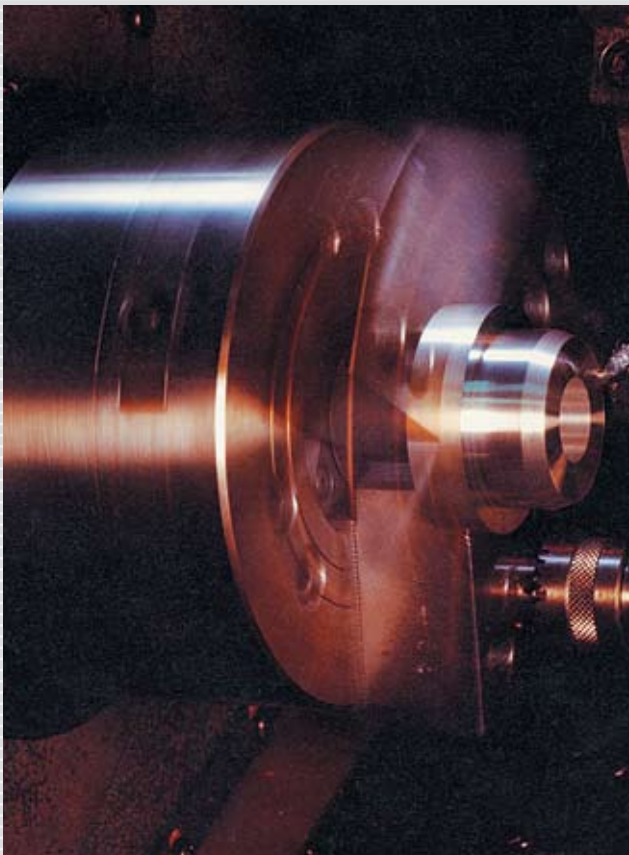

FUJI'S STRICT PRODUCTION
CONTROL SYSTEM CAN MEET A
WIDE VARIETY OF CUSTOMERS'
DEMANDS.

We believe it is an important policy to "ensure satisfaction of our customers demands". We have successfully established strict quality control systems in all processes from the design and development through the machining and assembly. In this way we are able to maintain the typical production system to accommodate the batch production necessary to satisfy the customer demand.

Such production systems and "know how" can only be materialized by Fuji Air Tools Co., Ltd., and allow us to manufacture over 2,000 different products (including more than 600 standard models and custom made models to suit the customer specification).

**EXCELLENT HUMAN RESOURCE
CREATES A POWERFUL ORGANISATION.**

At Fuji Air Tools we don't just "sell products"; we pride ourselves in delivering customer satisfaction!
Our activities based on our policies include product proposal information and production process & applications consulting to ensure that you can purchase our products with total satisfaction. All information from our customers' is fed back to our development and production department to ensure that customer satisfaction is "built in" as standard to our new products. Thus, our basic philosophy can be summarized in the words "we supply the quality of customer satisfaction".



**THE COMPLETE FOLLOW-UP SERVICE
SYSTEM IS THE DEFINITION OF OUR
QUALITY.**

One of our unchanging policies is that "real quality exists in the complete service and maintenance system to satisfy the customers' requirements". Through comprehensive customer support including service & maintenance systems and spare parts supply systems we aim for total customer satisfaction.



**OUR FINAL GOAL IS TO PROVIDE
100% CUSTOMER SATISFACTION WHILE FULLFILLING OUR OBLIGATION OF
CONTINUAL IMPROVEMENTS TO PROTECT THE ENVIRONMENT.**

We at Fuji Air Tools Co., Ltd., were awarded ISO 9001 QMS certification in 1996. This has significantly improved the level of our quality assurance capabilities. Alongside this we have invested significantly in research and actions to provide human, and environment, oriented tools through the utilization of ergonomic technology to provide the work environment where issues such as noise and vibration are fully considered. Thus, our ethos is always to deliver products that are ergonomic and reliable for our customers.

An important factor of our business is the preservation of the earth's environment. To fulfill our duty we obtained ISO 14001 EMS certification in 1998. As an Earth Citizen we continually strive to provide improvements to benefit the environment. Our ultimate goal is to attain 100% customer satisfaction, based on our philosophy "customer satisfaction is our satisfaction" by maintaining ISO 9001 QMS at a far higher level than required. With our motto "Fuji, with utmost passion for ECO-QUALITY", we make every possible effort for continuous improvement for the future of the Earth and the human being.

Your Guide to Our Catalogue

Model Names

Categories

Pulse Wrenches Shut-off

PULSE WRENCHES SHUT-OFF TYPE PAT.P

"FPT Series" are provided with Fuji patented original shut-off control mechanism having a dual chamber motor and two blade pulsing mechanism. It is designed for giving high torque at low speed, which gives the best characteristics for fast, reliable and accurate tightening. FPT series contribute to high productivity, quality improvement, working environment improvement, and operator fatigue minimization in various industries.

SQUARE DRIVE TYPE

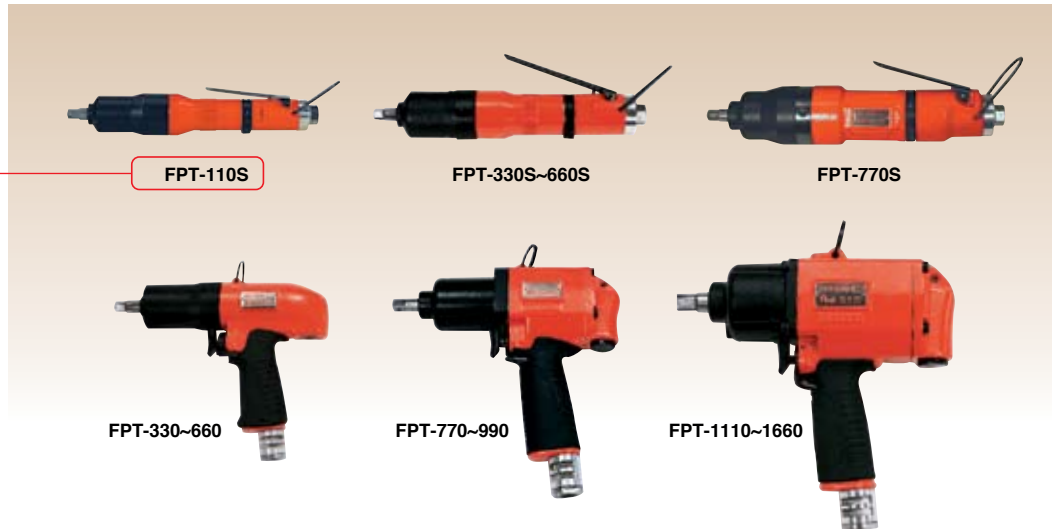

Model Numbers

Specifications

Models to be operated at air pressure 0.5MPa to 0.63MPa

Model	Bolt Size	Recommended Torque Range			Rotational Frequency	Square Drive Size		Overall Length		Mass (without socket)		Air Consumption (at Load)	
		mm	N · m	kgf · m		ft · lb	mm	in	mm	in	kg	lb	m ³ /min
Straight Models													
FPT-110S-1	M4~M5	4~7	0.4~0.7	3.0~5.2	4,500	9.5	3/8	236.5	9 5/16	0.85	1.9	0.20	7.1
FPT-330S-1	M5~M6	6~10	0.6~1.0	4.4~7.4	4,400	9.5	3/8	249	9 13/16	1.1	2.4	0.35	12.3
FPT-440S-1	M5~M6	8~13	0.8~1.3	5.9~9.6	5,000	9.5	3/8	250	9 27/32	1.1	2.4	0.35	12.3
FPT-550S-1	M6~M8	12~20	1.2~2.0	8.9~14.8	5,000	9.5	3/8	250	9 27/32	1.1	2.4	0.35	12.3
FPT-660S-1	M6~M8	20~30	2.0~3.1	14.8~22.1	5,000	9.5	3/8	262	10 21/64	1.1	2.4	0.50	17.6
FPT-770S-1	M8~M10	30~45	3.1~4.6	22.1~33.2	5,500	9.5	3/8	273.5	10 49/64	1.6	3.5	0.45	15.9
Pistol Grip Models													
FPT-110-1	M5~M6	4~7	0.4~0.7	3.0~5.2	6,000	9.5	3/8	194.5	7 21/32	0.95	2.1	0.20	7.1
FPT-330-1	M5~M6	6~11	0.6~1.1	4.4~8.1	6,000	9.5	3/8	198	7 51/64	1.2	2.6	0.39	13.8
FPT-440-1	M6	10~18	1.0~1.8	7.4~13.3	6,700	9.5	3/8	193	7 39/64	1.2	2.6	0.35	12.3
FPT-550-1	M6~M8	15~25	1.5~2.6	11.1~18.4	5,800	9.5	3/8	193	7 39/64	1.2	2.6	0.40	14.1
FPT-660-1	M6~M8	20~35	2.0~3.6	14.8~25.8	5,400	9.5	3/8	202	7 61/64	1.3	2.9	0.40	14.1
FPT-770-1	M8	30~45	3.1~4.6	22.1~33.2	6,300	9.5	3/8	200	7 7/8	1.6	3.5	0.45	15.8
FPT-880-3	M8~M10	40~60	4.1~6.1	29.5~44.3	5,800	12.7	1/2	214	8 7/16	2.0	4.4	0.50	17.6
FPT-990-1	M10	55~80	5.6~8.2	40.6~59.0	4,800	12.7	1/2	215	8 15/32	2.4	5.3	0.55	19.4
FPT-1110-1	M10~M12	75~130	7.7~13.3	55.3~95.9	4,400	12.7	1/2	216	8 1/2	2.6	5.7	0.60	21.1
FPT-1330-1	M12~M14	90~160	9.2~16.3	66.4~118.0	3,600	12.7	1/2	228	8 31/32	3.2	7.0	0.74	26.1
FPT-1660-1	M16~M18	150~210	15.3~21.4	110.6~154.9	2,800	19.0	3/4	266	10 31/64	4.4	9.7	1.2	42.4

*Use all above models at 0.5-0.63 MPa(5.0-6.3 kgf/cm²) air pressure but FPT-110 series at 0.4-0.63 MPa (4.0-6.3 kgf/cm²) air pressure.
 *Performance figures are at 0.63 MPa(6.3 kgf/cm²) air pressure. *Air Inlet Thread Size: PT or NPT 1/4", (FPT-1660) PT or NPT 3/8".
 *Air Hose Size: (FPT-110S, 330S, 440S, 550S, 110, 330, 440, 550) 6.3mm (1/4"). (660S, 770S, 660~1660) 9.5mm (3/8").

Housing, Throttle Type

Models to be operated at air pressure 0.4MPa to 0.5MPa

Model	Bolt Size	Recommended Torque Range			Rotational Frequency	Square Drive Size		Overall Length		Mass (without socket)		Air Consumption (at Load)	
		mm	N · m	kgf · m		ft · lb	mm	in	mm	in	kg	lb	m ³ /min
Pistol Grip Models													
FPT-440-1L	M6	10~15	1.0~1.5	7.4~11.1	5,400	9.5	3/8	193	7 39/64	1.2	2.6	0.19	6.7
FPT-550-1L	M6~M8	12~20	1.2~2.0	8.9~14.8	4,900	9.5	3/8	193	7 39/64	1.2	2.6	0.20	7.0
FPT-660-1L	M6~M8	13~28	1.3~2.9	9.6~20.7	4,600	9.5	3/8	202	7 61/64	1.3	2.9	0.20	7.0
FPT-770-1L	M8	28~40	2.9~4.1	20.7~29.5	5,300	9.5	3/8	200	7 7/8	1.6	3.5	0.30	10.5
FPT-880-3L	M8~M10	38~48	3.9~4.9	28.0~35.4	5,200	12.7	1/2	214	8 7/16	2.0	4.4	0.30	10.5
FPT-990-1L	M10	40~60	4.1~6.1	29.5~44.3	4,200	12.7	1/2	215	8 15/32	2.4	5.3	0.33	11.6
FPT-1110-1L	M10~M12	65~100	6.6~10.2	47.9~73.8	3,800	12.7	1/2	216	8 1/2	2.6	5.7	0.37	13.0
FPT-1330-1L	M12	80~130	8.2~13.3	59.0~95.9	3,100	12.7	1/2	228	8 31/32	3.2	7.0	0.48	16.9

*Use all above models at 0.4-0.5 MPa(4.0-5.0 kgf/cm²) air pressure. *Performance figures are at 0.4 MPa(4.0 kgf/cm²) air pressure.
 *Air Inlet Thread Size: PT or NPT 1/4". *Air Hose Size: (440, 550) 6.3mm (1/4"). (660~1330) 9.5mm (3/8").

About The Specifications on Our Catalog

1) Model Number

Use this model number when ordering. You will find the details of the model numbers on page 6 "How to understand Fuji model numbers".

2) Bolt Size, Capacity

Shows the capacity, which the tool can handle, as guidance for a tool selection. The bolt size of a fastening tool is a bolt size which the tool may fasten.

The capacities shown on this catalogue as drilling capacity, tapping capacity, riveting capacity, etc. show the size which the tool may handle. Be aware, that the capacity may vary depending on such conditions as the tension, joint rate, material, etc. of the work.

3) Recommended Torque Range, Max Torque

Shows recommended torque range or max torque of the model. Torque figures in the specifications must be used as guidance only, as final output depends on type and size of fastener, joint rate and air pressure etc.

4) Rotational Frequency

Rotational frequency is indicated in revolutions per minute, min⁻¹ at which the tool runs at no load at the working air pressure of 0.63MPa, 6.3bar, 90psi if not otherwise specified.

5) Overall Length

Shows the longest part of the tool without accessories attached. Refer to the last part of this catalogue "Dimensions" if the details of dimensions are necessary.

6) Mass

Shows the mass of the tool without accessories.

7) Square Drive Size, Bit Shank Size

Square drive size shows the square size of the spindle or anvil of pulse wrenches and impact wrenches. Bit shank size indicates the bit shank size of the driver anvil of screw drivers.

8) Hex. Socket Size

Shows standard hexagonal size of the socket of the ratchet wrenches.

9) Air Inlet Thread Size

Female threaded PT (Pipe Threads) and NPT (National Pipe Threads) are available.

10) Air Hose Size

The air hose size indicates recommended minimum hose inside diameter which is necessary to supply enough volume of air to the tool for designed performance.

11) Air Consumption

The air consumption of the tools is stated in m³/min, cubic meters per minute. It indicates the maximum air consumption at the working air pressure 0.63MPa, 6.3bar, 90psi if not otherwise stated.

Maximum air consumption is valid for the tool without a speed governor when the tool is running at no load.

Conversion Factors

Length	1 m	=1000 mm	=39.4 in	=3.28 ft
Diameter, Width, Depth, Height	1 in	=25.4 mm	=0.0254 m	=0.0833 ft
Thickness, Lift, Size	1 cm	=10 mm	=0.394 in	
Side to Center	1 ft	=12 in	=0.3048 m	=304.8 mm
Capacity Stroke				
Mass	1 kg	=1000 g	=2.20462 lb	
	1 lb	=0.45359237 kg		
Torque	1 N · m	=0.7375 ft · lb	=0.102 kgf · m	
Recommended Torque Range	1 kgf · m	=9.807 N · m	=7.233 ft · lb	
Max. Torque, Measuring Range	1 ft · lb	=1.3558 N · m	=0.138 kgf · m	
Stall Torque, Starting Torque				
Force	1 N	=0.102 kgf	=0.225 lbf	
Lifting Capacity	1 kgf	=9.807 N	=0.205 lbf	
	1 lbf	=4.448 N	=0.454 kgf	
	1kN	=1000 N	=102 kgf	
Pressure	1 Pa	=1 N/m ²		
Air Pressure	1 bar	=100 kPa	=0.1 MPa	=1.0197 kgf/cm ²
Vacuum Degree	1 MPa	=10.2kgf/cm ²	=10 bar	
	1 kPa	=0.01 bar	=0.0102 kp/cm ²	=7.5 mmHg
	1 kp/cm ²	=98.07 kPa		
Power	1 W	=0.102 kgf · m/s	=0.738 ft · lb/s	
Power Consumption	1 W	=1 J/s	=1 N · m/s	=1VA
Motor Output, Horse Power	1kgf · m/s	=9.807 W	=0.0133 PS	=7.233 ft · lb/s
	1 PS	=75 kgf · m/s	=0.7355 kW	
	1 kW	=1000 W		
Volume	1 m ³	=35.3 ft ³		
	1 m ³	=1000 ℓ	=1 kℓ	
	1 ℓ	=1000 cm ³	=0.001 m ³	
	1 ft ³	=28.3 ℓ		
Flow Rate	1 m ³ /s	=60 m ³ /min		
Max. Air Consumption	1 m ³ /min	=35.3 ft ³ /min		
Discharge Volume	1 m ³ /h	=16.667ℓ/min	=0.2778ℓ/s	
Discharge Capacity	1 m ³ /min	=16.667ℓ/s		
	1 ℓ/s	=2.1189 cfm		
	1 cfm	=0.4719ℓ/s		
Velocity	1 m/s	=3.28 ft/s	=3.6km/h	=60 m/min
Rope Speed, Lifting Speed	1 ft/s	=0.3048 m/s	=1.0973 km/h	
Propelling Speed	1 km/h	=0.278 m/s	=0.911 ft/s	
Rotational Frequency	1 s ⁻¹	=60 rpm		
Free Speed, Pinion Speed	1 min ⁻¹	=1 rpm	=Peripheral Speed (m/min) x 1000	
Measuring Range			$\pi \times \text{Wheel Diameter (mm)}$	($\pi = 3.14$)
Frequency	1 Hz	=60 bpm	=60 spm	
Blow, Stroke per minute	1 kHz	=1000 Hz		

How to understand Fuji model numbers

The model number of Fuji tools is formed by three elements of a combination of letters and numbers indicating the various properties and characteristics of the tools concerned. The first combination of letters indicates the group category that the model belongs to. "FRD" of the model FRD-6PX-3, for example, indicates that this model belongs to the group of "Fuji Rotary Drill". The second part "6PX" shows the capacity in numbers like wheel size, bolt size, horse power etc. and also shows the types of throttle handle, exhaust direction and housing etc. in letters. In this case, "6" indicates drilling capacity and "PX" indicates pistol handle and rear exhaust. The third part "3" shows the generation of models in numbers and types of handle, length of anvil and driver bit etc. in letters. In this case, "3" indicates the order of production.

Controllers, Torque Testers

FFC	Fuji Fastening Controller
FMC	Fuji Multiple Fastening Controller
FFA	Fuji Fastening Adapter
FDT	Fuji Digital Torque Tester
TT	Torque Transducer
FDM	Fuji Digital Tachometer
FJT	Fuji Hydraulic Torque Tester

Wrenches, Drivers

FET	Fuji Electronic Torque Control Pulse Wrenches
FPT	Fuji Mechanical Shut-off Pulse Wrenches
FPW	Fuji Pulse Wrenches
FD	Fuji Screw Drivers
FW	Fuji Impact Wrenches
CA	Corner Attachments for Impact Wrenches
FRW	Fuji Ratchet Wrenches
FOW	Fuji Open Ratchet Wrenches

Grinders, Sanders

TURBO	Turbo Grinder
FG	Fuji Die Grinders or Straight Grinders
FA	Fuji Angle Grinders
FV	Fuji Vertical Grinders
FOS	Fuji Orbital Sanders
FOR	Fuji Orbital Sanders (Random)
FBS	Fuji Belt Sanders

Drills, Tappers

FRD	Fuji Rotary Drills
FRD	Fuji Corner Drills
FT	Fuji Tappers

Hammers, Chippers, Rammers

FCH	Fuji Chipping Hammers
FC	Fuji Calking Hammers
FRH	Fuji Riveting Hammers
FR	Fuji Rammers
FS	Fuji Scaling Hammers
FNS	Fuji Needle Scalers

Other products

FRF	Fuji Reciprocating File & Saw
FP	Fuji Pumps
FJP	Fuji Jet Pumps
FBM	Fuji Pipe Bevelling Machines
FM	Fuji Air Motor
FTD	Fuji Tip Dressers

PULSE WRENCHES

FPW-660SD-1

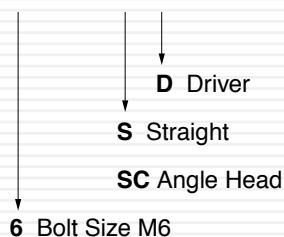

IMPACT WRENCHES

FW-66PAD-2

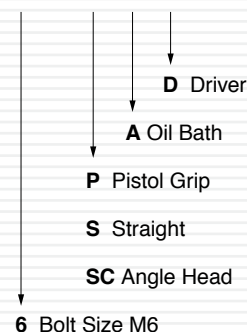

RATCHET WRENCH

F RW-8NX-2A

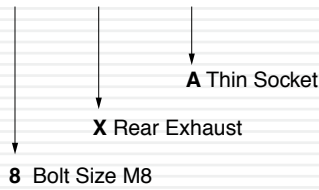

DIE GRINDERS

FG-26X-10F

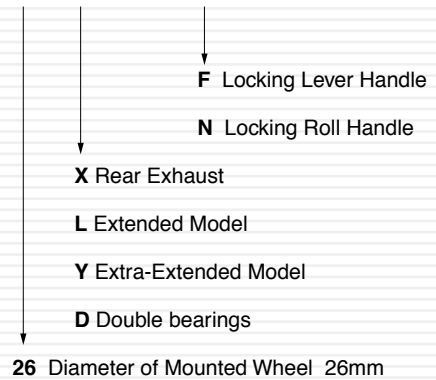

STRAIGHT, EXTENDED GRINDERS

FG-3HL-1F

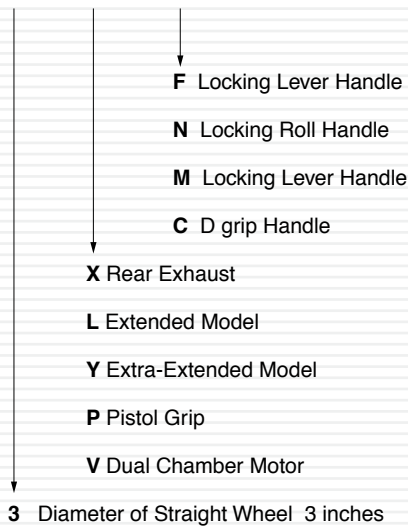

ORBITAL SANDERS

FOR-125BF-E

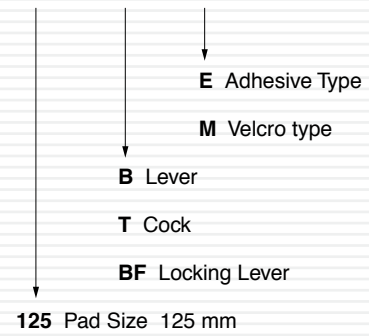

VERTICAL GRINDERS

F V-9BH-1M

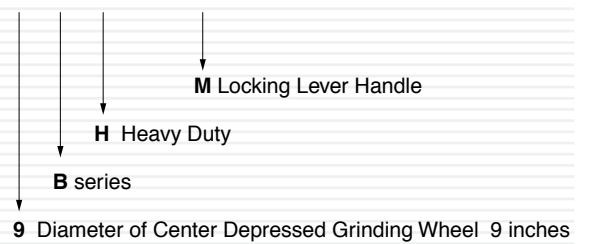

ANGLE GRINDERS, SANDERS

F A-4CHK-3F

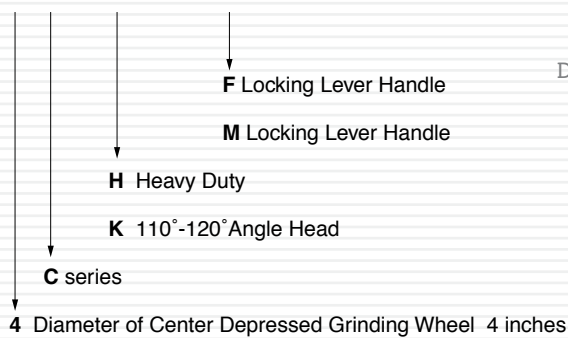

DRILLS

FRD-16Z-1C

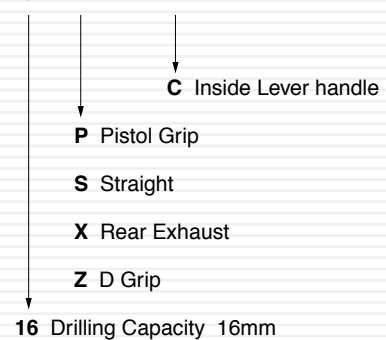

TAPPERS

F T-6BX-1

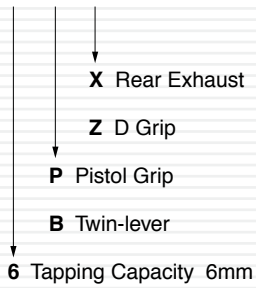

CHIPPING HAMMERS

FCH-20F

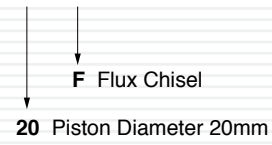

LIGHT HAMMERS

FRH-3-1

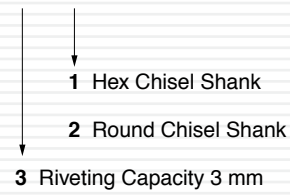

CALKING HAMMERS

FC-2Z-1

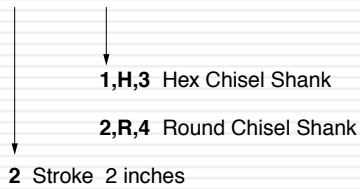

PUMPS

FP-20-1



RAMMERS

FR-22L-2F

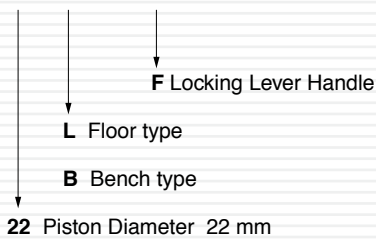

AIR MOTORS

F -6SM-5R

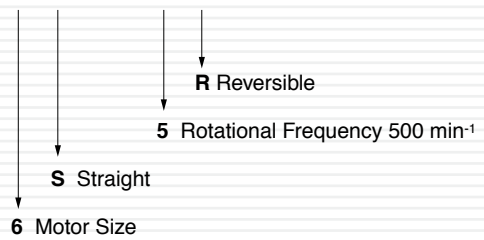

PIPE BEVELLING MACHINES

FBM-80A-6

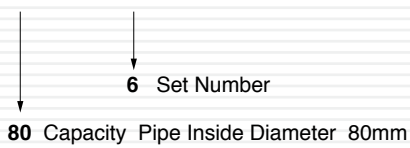

FM-2R-5

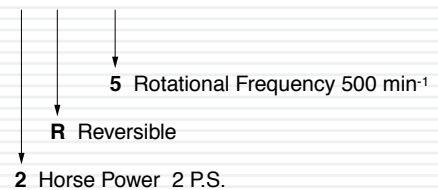

SELECTION GUIDE

TORQUE CONTROL SYSTEM

To accommodate the various requirements of torque control and assembly application, Fuji offers a complete range of fastening tools and reliable torque controllers designed to enhance quality and increase productivity. The following table shows various combinations of fastening tools and controllers. Choose the correct combination to meet your production requirements.

TOOLS		FW FOW FRW	FPW	FPT	FET	FW	FPW	FW	FPW	FW	FPW	FET
CONTROLLERS		-	-	-	-	FFC	FFC	FMC	FMC	FFC	FFC	-
COUNTDOWN ADAPTERS		-	-	-	-	-	-	FMC	FMC	FFA	FFA	FFA
TORQUE ADJUSTMENT			•	•	•	•	•	•	•	•	•	•
SHUT-OFF				•	•	•	•	•	•	•	•	•
PRINT OUT	FASTENING NG/GOOD				○	○	○	•	•	○	○	○
	FASTENING TORQUE				○							○
LINE INPUT						•	•	•	•	•	•	•
LINE OUTPUT	FASTENING NG/GOOD				•	•	•	•	•	•	•	•
	FOOL PROOF NG/GOOD							•	•	•	•	•
	FASTENING TORQUE				•							•
DATA MEMORY					•							•
PC NETWORK					○	○	○	○	○	○	○	○

* ○ available with optional accessories FFC: FFC-3-1 FFA: FFA-2-2/FFA-3-1

TIGHTENING TORQUE (N · m)

This table shows the recommended tightening torque for common bolt size M2 to M48.

Bolt Size	Bolt Grade							Bolt Size	Bolt Grade					
mm	3.0	4.6	4.8	5.8	8.8	10.9	12.9	mm	4.6	4.8	5.8	8.8	10.9	12.9
M2	0.10	0.13	0.17	0.22	0.35	0.49	0.58	M18	103	121	172	275	386	463
M3	0.35	0.46	0.61	0.77	1.20	1.70	2.10	M20	144	170	240	385	541	649
M4	0.81	1.10	1.40	1.80	2.90	4.00	4.90	M22	194	230	324	518	728	874
M5	0.60	2.20	2.95	3.60	5.70	8.10	9.70	M24	249	295	416	665	935	1120
M6	2.80	3.70	4.90	6.10	9.80	14.0	17.0	M27	360	435	600	961	1350	1620
M8		8.9	10.5	15	24	33	40	M30	492	590	819	1310	1840	2210
M10		17	21	29	47	65	79	M36	855	1030	1420	2280	3210	3850
M12		30	36	51	81	114	136	M42	1360		2270	3640	5110	6140
M14		48	58	80	128	181	217	M45	1690		2820	4510	6340	7610
M16		74	88	123	197	277	333	M48	2040		3400	5450	7660	9190

according to ISO898/1

RECOMMENDED TORQUE RANGE

The torque requirement is one of the major factors to be considered when selecting fastening tools. The following graphic presentation shows the recommended torque range of our assembly tools. This is to be used for guidance only as final torque may vary depending in the type and size of the fastener, the joint rate, air pressure, etc.

Optimum performance is achieved at the mid range of the tool's torque capability.

ELECTRONIC TORQUE CONTROL PULSE WRENCHES

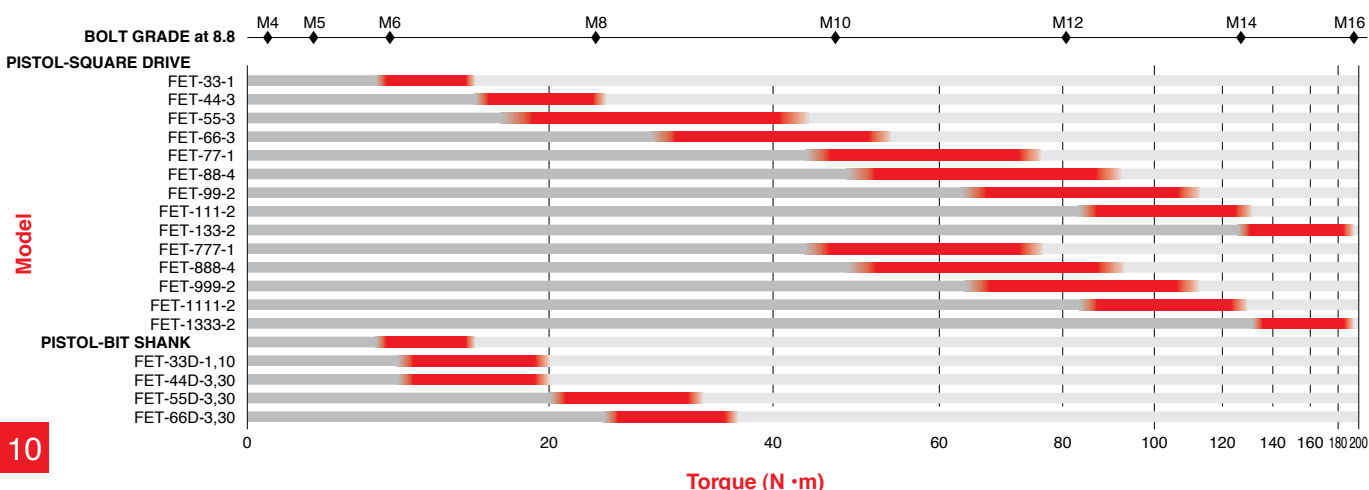

PULSE WRENCHES SHUT-OFF TYPE

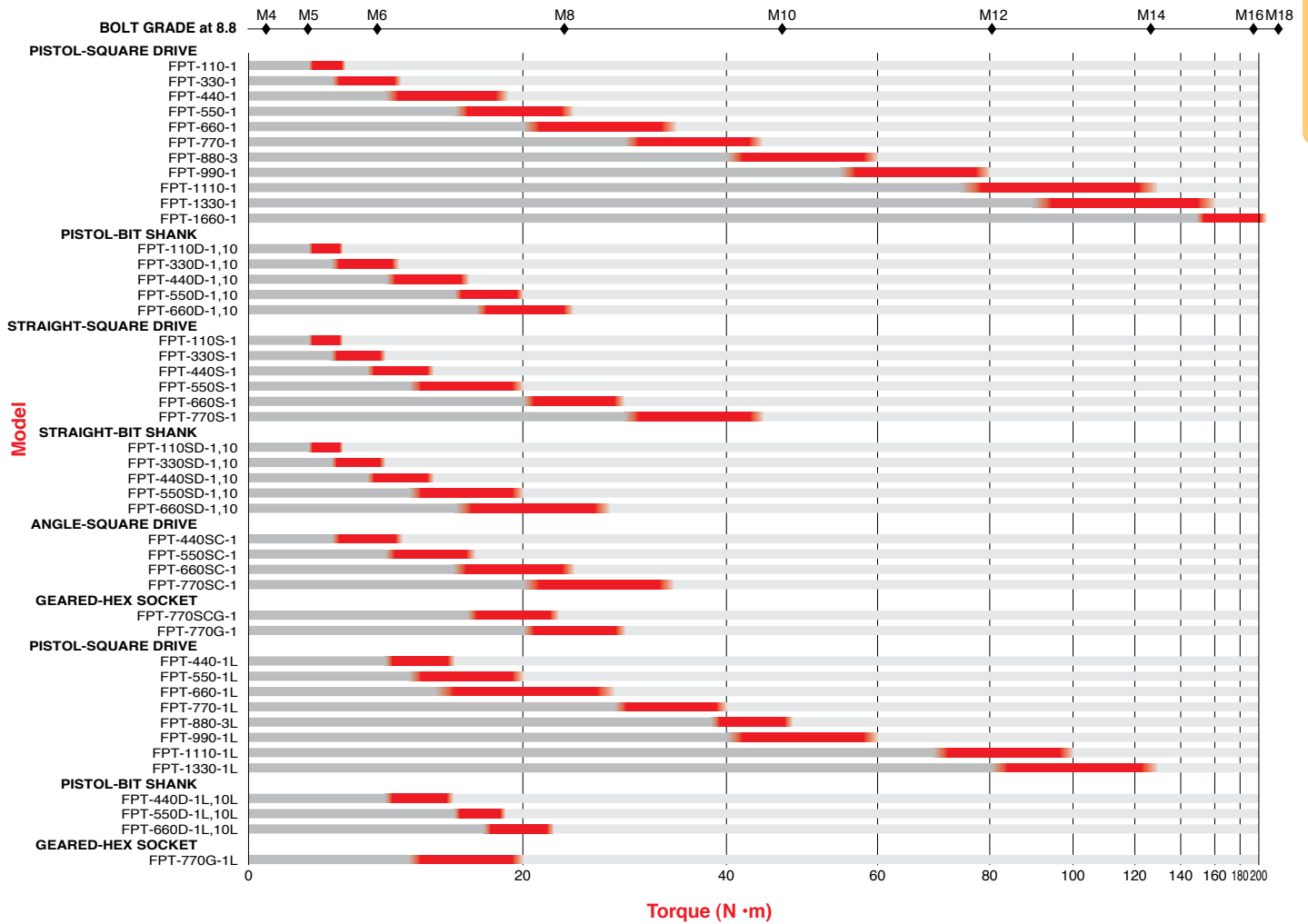

PULSE WRENCHES

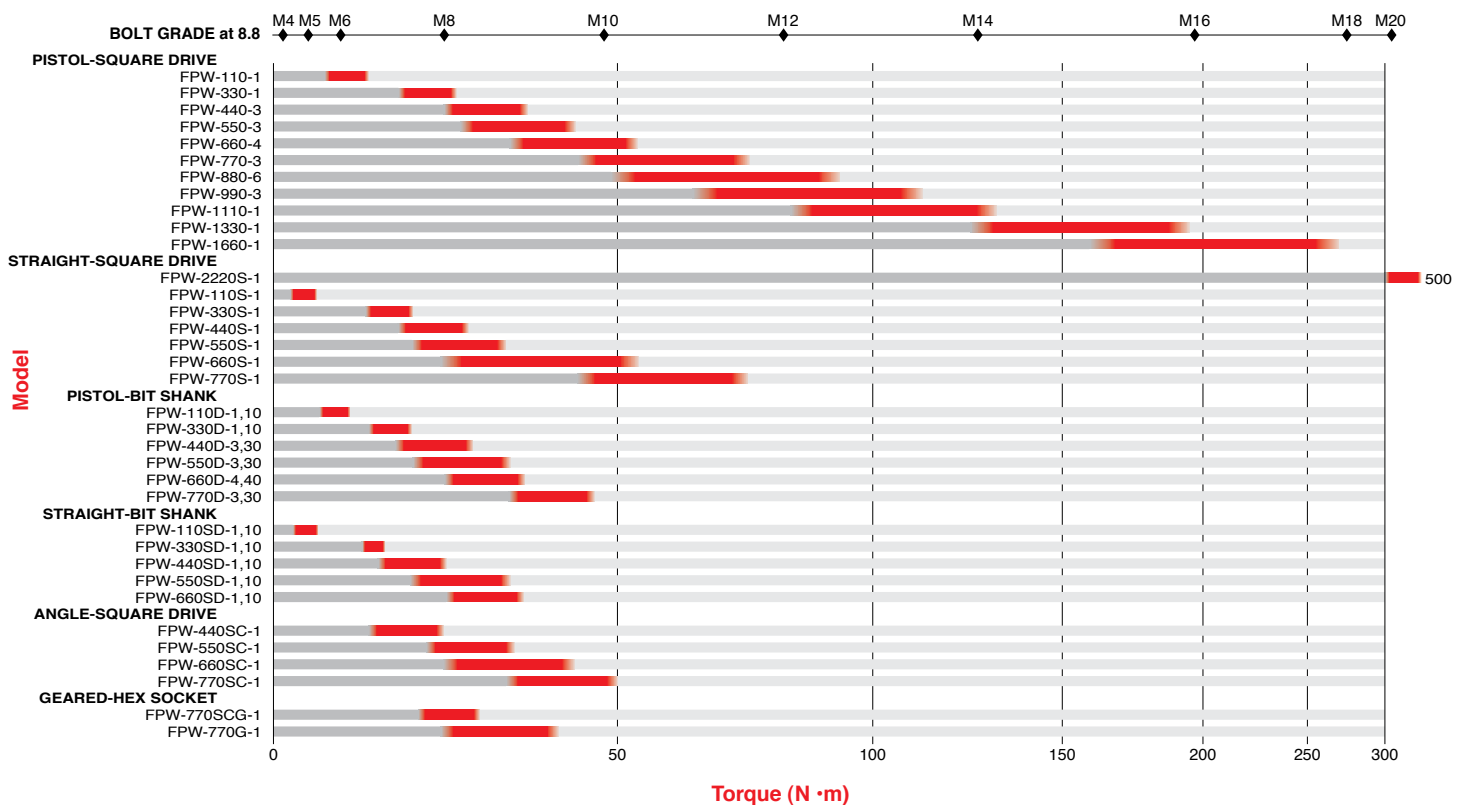

Torque range should be used for guidance only as final torque may vary depending in the type and size of fastener, the joint rate, air pressure etc. Optimum performance is achieved at the mid range of the tool's torque capability.

Assembly Tools

IMPACT WRENCHES

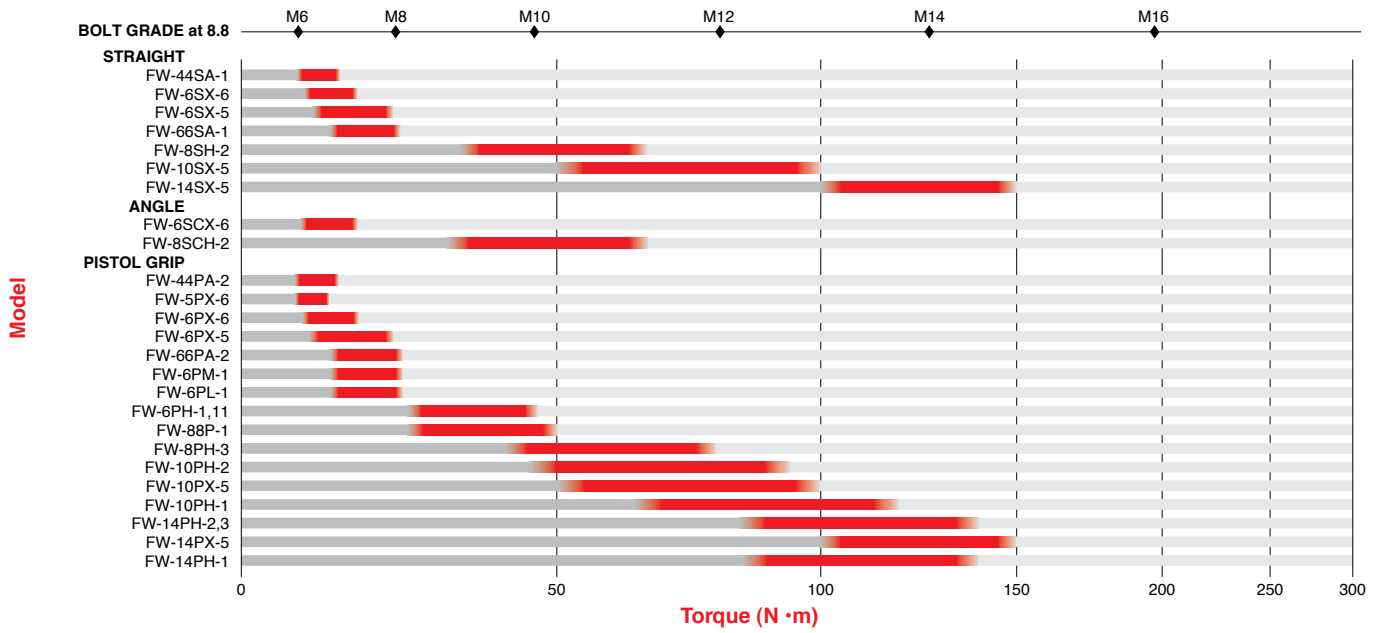

SCREW DRIVERS

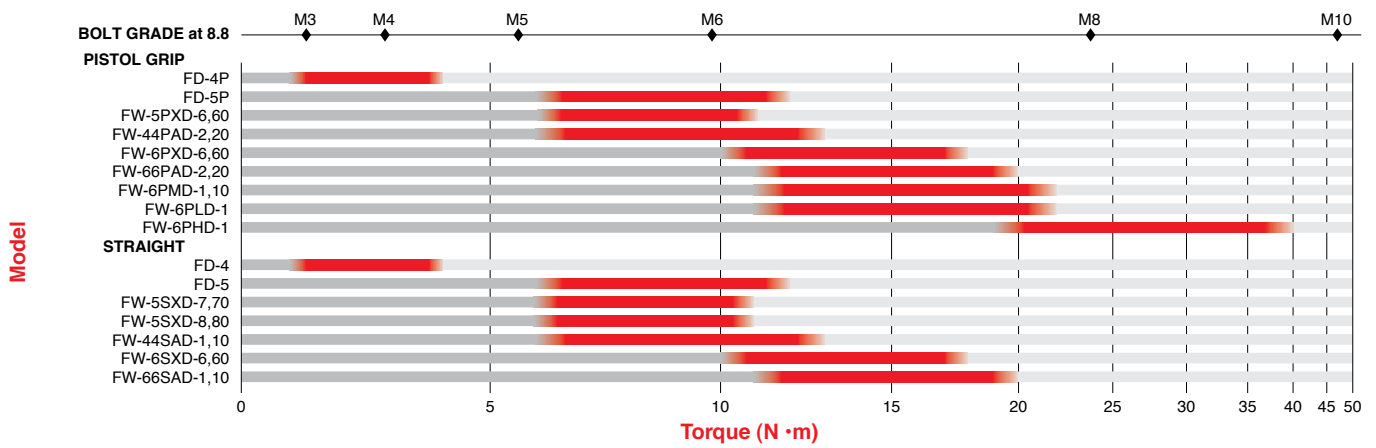

IMPACT WRENCHES

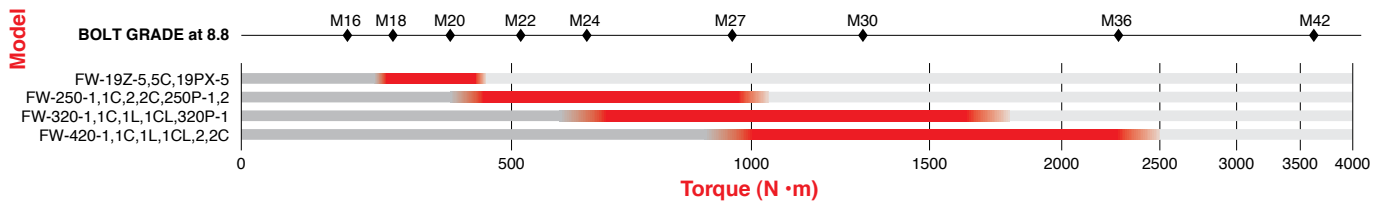

LARGE IMPACT WRENCHES

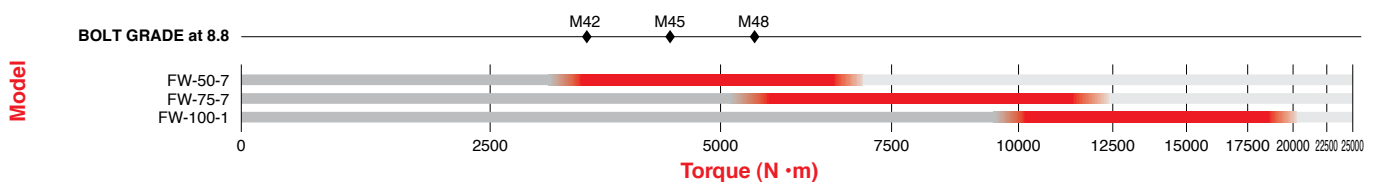

Torque range should be used for guidance only as final torque may vary depending in the type and size of the fastener, the joint rate, air pressure, etc. Optimum performance is achieved at the mid range of the tool's torque capability.

Assembly Tools

SELECTION GUIDE	10
TORQUE CONTROL SYSTEM	
TIGHTENING TORQUE	
RECOMMENDED TORQUE RANGE	
FEATURES	13
[Controllers / Testers]	
FASTENING CONTROLLERS	15
COUNTDOWN ADAPTER	16
MULTI-FASTENING ADAPTER	16
HYDRAULIC TORQUE TESTERS	18
DIGITAL TORQUE TESTERS	18
OIL FILLER	19
PORTABLE DIGITAL TACHOMETER	19
[Electronic Torque Control Pulse Wrenches]	
ELECTRONIC TORQUE CONTROL PULSE WRENCHES	20
VERSATILE APPLICATIONS	21
[Pulse Wrenches Shut-off type]	
PULSE WRENCHES SHUT-OFF TYPE	23
CUSTOM-MADE PRODUCTS.....	25
GEARED PULSE WRENCHES SHUT-OFF TYPE	25
[Pulse Wrenches]	
PULSE WRENCHES	26
GEARED PULSE WRENCHES	28
[Impact Wrenches]	
"DUAL CHAMBER MOTOR" IMPACT WRENCHES	29
IMPACT WRENCHES	30
[Screw Drivers]	34
[Open-end Wrenches / Ratchet Wrenches]	
OPEN-END WRENCHES	36
RATCHET WRENCHES	36
[Accessories-Assembly Tools]	37



FEATURES

1 EXHAUST WITH A MUFFLER

Our original built-in, swivel type, exhaust muffler is designed to reduce the noise level of the tool. The operator can also select a suitable direction of the exhaust air to minimise the risk of blowing any dust or debris in to the local work environment.

ALL WRENCHES EXCEPT FW-6PL, 6PLD, 5SXD-8, 80, FD-4, 5, 4P, 5P



REAR EXHAUST MUFFLER



FRONT EXHAUST
FPW-2220S, FW-19Z, 250~420,
FW-50, 75, 100

2 TWO STAGE / SQUEEZING TYPE THROTTLE VALVE MECHANISM

The two stage / squeeze type throttle enables the operator to start the tool slowly and increase to full speed to aid location of the fastening at the start of the cycle.

TWO STAGE TYPE : FET, FPT, FPW, FW-6PM, 44P~88P

SQUEEZING TYPE : FPT-*S, FPW-*S, FW-44S~66S, FOW, FRW



3 REVERSE VALVE LEVER

All models feature a reversible motor. The operator can easily and quickly select the direction of rotation simply by turning or sliding the reverse actuator.

ALL WRENCHES EXCEPT FOW, FRW



FPW pistol, straight

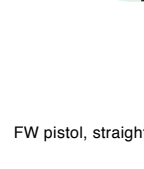

FW pistol, straight



4 AIR REGULATOR

To accommodate torque adjustment, the built in air regulator is used to regulate the air flow.

FW-6SX, 8SH, 10SX, 14SX, 6SCX, 8SCH, 50~100

FW-6PX, 10PX, 14PX, 19Z, 420 SERIES



5 SQUARE DRIVE ANVIL

Two types of square drive anvils are available. As our standard for overseas, the models larger than 25.4 mm (1 inch) square drive are supplied with P anvil (Pin hole retainer type) and the models smaller than 19 mm (3/4 inch) square drive are supplied with BF anvil (Flat button retainer type). Small models can be supplied with P anvil on your request.

ALL WRENCHES WITH SQUARE DRIVE ANVIL



P ANVIL



BF ANVIL

6 BIT SHANK TYPE ANVIL FOR SCREW DRIVERS

Two types of quick-change bit shank type anvils are available. Both are for 6.35 mm (1/4 inch) hex driver bit, but divided into two model groups according to the bit neck size.

ALL SCREW DRIVERS

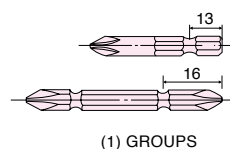

(1) GROUPS

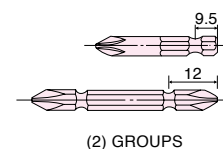

(2) GROUPS



7 CLUTCH MECHANISM—IMPACT WRENCHES AND DRIVERS

1) DOUBLE CLUTCH TYPE

The impact force is balanced with less torque reaction due to two impacts made per revolution.

The double clutch type impact wrenches and drivers benefit from less vibration and longer service life than conventional single clutch models.

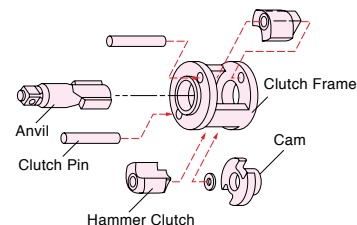

2) SINGLE CLUTCH TYPE

The impact force is harder and torque/weight ratio is better than the double clutch type. Single clutch type models are suitable for hard "pull-up" fastening operations for maintenance & service applications.

FW-6PX, 6SX-5, 10PX, 10SX-5, 14PX, 14SX-5, 19Z, 19PX-5, 5C

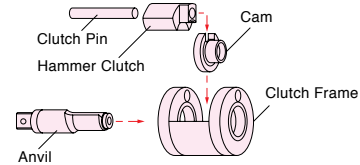

3) 2-JAW ONE-DOG CLUTCH TYPE

The Fuji 2-Jaw clutch impact wrenches generate very high torque/weight. These types of tool are most suited for tightening prevailing torque bolts and for removing corroded fasteners.

FW-250, 320, 420 SERIES

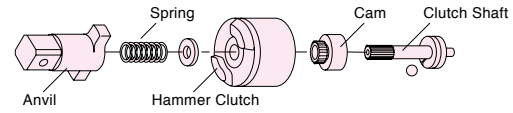

8 HANDLE PROTECTOR

Ergonomically designed handle protectors provide reduced vibration, increased operator comfort and insulate the hand from the cold temperature generated by compressed air.

PISTOL GRIP MODELS : FET, FPT, FPW, FW-6PM, 44P~88P



9 DUAL CHAMBER MOTOR

All Fuji pulse wrench models (FET, FPT & FPW) and the new series of impact wrenches (FW-44~88) are built with a 9 blade, dual chamber motor. This motor is designed to provide high torque at low speed, giving the best characteristics for fast reliable and accurate tightening.

CROSS SECTION

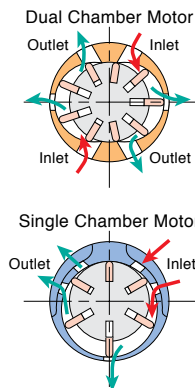

EFFICIENCY COMPARISON

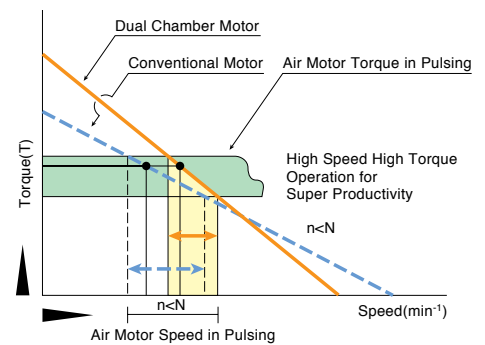

10 2-BLADE PULSE UNIT

As the pulsing cycle is very short, there is almost no torque reaction in the handle grip (low motor torque only is felt by the operator). Unlike an impact wrench, the pulse tool has no "metal to metal" contact and consequently the pulse wrenches provide softer and stable "impulsing". The benefits from this are less vibration, lower noise levels and longer service life when compared with conventional impact wrenches. All pulse wrenches models (FET, FPT & FPW series) utilise the Fuji patented 2 blade pulse unit combined with the dual chamber motor. This combination provides 50% higher power to weight ratio than comparable fastening tools. For productivity, this design reaches torque faster, is excellent for soft joint or prevailing torque applications with reduced noise and vibration levels.

FET, FPT, FPW SERIES

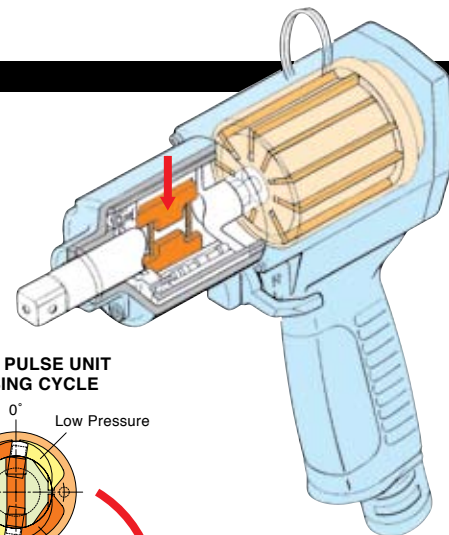

2-BLADE PULSE UNIT IMPULSING CYCLE

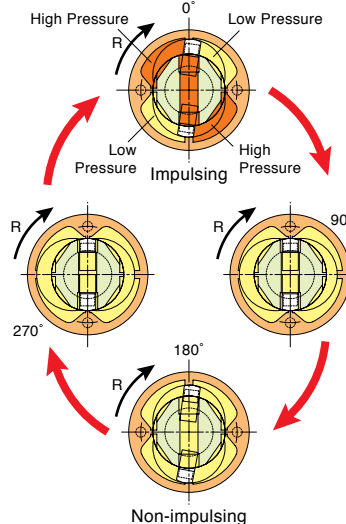

FASTENING CONTROLLERS PAT.

Fuji Fastening Controllers make accurate torque control easy and quick by installing the controller into your existing piping and wiring system with any impact wrenches or pulse tools regardless of type or manufacturer. A unique, patented torque control system that monitors/converts air pressure and blow frequency to an AC electrical signal. When the pre-set criteria is achieved, the controller shuts off the air flow. Torque being based on the number of equal (valid) blows can be repeated if the same pressure and number of blow is repeated. FMC-1-1 and FFC-3-1 provide accurate torque repeatability for use in major car manufacturer's assembly lines.

Multi-Fastening Controller



FMC-1-1

Features

- Three wrenches can be connected to one FMC Fastening Controller. (Three tools can not be used at the same time.)
- FMC Fastening Controller processes air pressure variation digitally and calculates fastened value automatically to control the wrench properly.
- "Step Function" makes it possible to set 72 different torque settings.
- Irregularities and errors such as double fastening, sticking/damaged threads, deterioration of the wrench, etc. that can occur during the fastening operation are readily detected.
- RS-232C port is equipped to communicate with external equipment such as the host computer and/or printer. (option)
- Signals needed to make countdown control can be chosen to meet various countdown controls. Their output timing can be also adjusted.

Model	Dimensions						Mass		Power Sources			Power Consumption
	Width		Height		Depth				In	Out	W	
	mm	in	mm	in	mm	in	kg	lb	V	Hz	V	
FMC-1-1	254	10	105	4 9/64	203	8	3.7	8.1	AC100-240	50/60	AC100-240	15

STRUCTURE

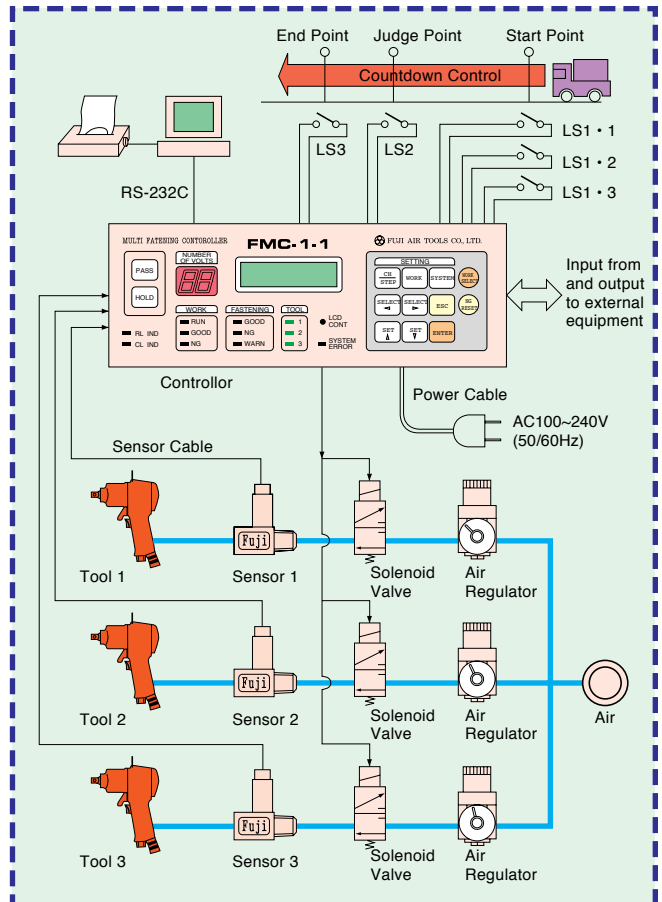

Fastening Controller



FFC-3-1

Features

- Bright LED display for quick and accurate setting.
- Built in level monitors for easy blow reading and count level setting.
- Built in buzzer provides easy and quick audible notification of OK & NOK(NG).
- 7 channels for 7 different torque values, with 7 different tools (One at a time).
- Senses irregular fastenings as NOK(NG).

- 1) Cross threaded fastening.
- 2) Stripped fastening.
- 3) Double fastening.
- 4) Over Torque.
- 5) Low Torque.
- 6) Deterioration of tools.

- FFA-2-2 Countdown adapters can be connected for fastening bolt number audit.
- Overall supervision of assembly lines is also possible with FFA-3-1 multi-fastening adapter and personal computer through Fuji "FV-NET" network.

STRUCTURE

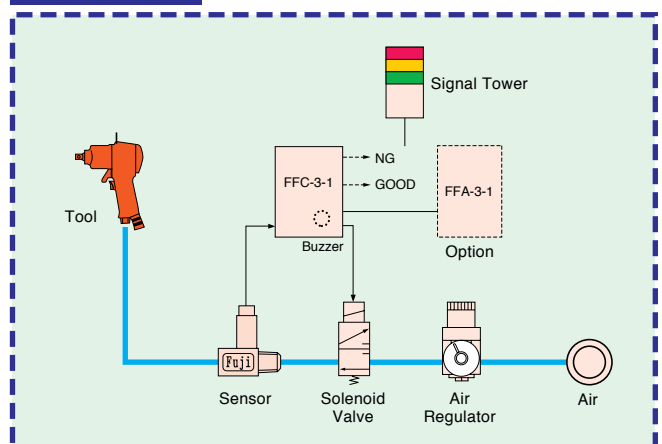

Model	Dimensions						Mass		Power Sources			Power Consumption
	Width		Height		Depth				In	Out	W	
	mm	in	mm	in	mm	in	kg	lb	V	Hz	V	
FFC-3-1	108	4 1/4	180	7 3/32	245	9 21/32	2.3	5.1	AC100-240	50/60	DC24	8

Controllers/Testers

Level Monitor



FLM-1

Features

Associated with the FFC-2-1 Fastening Controller, the FLM-1 Monitor displays the fastening status via a bar chart to accommodate easy setting of the count level. This visual confirmation can also serve as an indicator of the tool's performance.

Model	Dimensions						Mass		Power Consumption
	Width		Height		Depth		kg	lb	W
	mm	in	mm	in	mm	in			
FLM-1	34	1 11/32	170	6 45/64	100	3 15/16	0.7	1.5	0.45

COUNTDOWN ADAPTER

Fuji FFA-2-2 Countdown Adapter is useful for fastening bolt number audit associated with FFC-3-1 Fastening Controller, FET Electronic Torque Control Pulse Wrenches, FPT Shut-off Pulse Wrenches and FPW Pulse Wrenches. Tamperproof devices like Buzzer or Display can be connected for quick notice of countdown error.



FFA-2-2

Model	Dimensions						Mass		Power Sources	Power Consumption
	Width		Height		Depth		kg	lb	V	W
	mm	in	mm	in	mm	in				
FFA-2-2	125	4 59/64	62	2 29/64	25	63/64	0.3	0.7	DC24	3

MULTI-FASTENING ADAPTER

Fuji FFA-3-1 multi-fastening adapter is designed for fastening bolt number audit which is made with FFC Fastening Controller and FET Electronic Torque Control Pulse Wrenches. A unit of FFA-3-1 can manage up to 5 units of FET wrenches or up to 4 units of FFC. Overall supervision of assembly lines is possible through Fuji unique communication network "FV-NET" with personal or host computer which can accommodate up to 100 units of FET wrenches and 20 units of FFA-3-1 within a distance of 1 kilometer.

Features

- 99 operation patterns programmable function.
- Up to 5 FET tools controllable with one FFA-3-1.
- Productive operation with "Step" function of automatic switch-over of operation programs.
- Overall assembly line supervision linked with our communication network FV-NET.
- Various bolt countdown pattern setting for tamper proof.



Model	Dimensions						Mass		Power Sources			Power Consumption
	Width		Height		Depth		kg	lb	Power Sources			
	mm	in	mm	in	mm	in			V	Hz	V	
FFA-3-1	210	8 9/32	85	3 11/32	160	6 19/64	2.8	6.2	AC100-240	50/60	AC100-240 DC12	8

ACCESSORIES FOR FMC-1-1, FFC-3-1

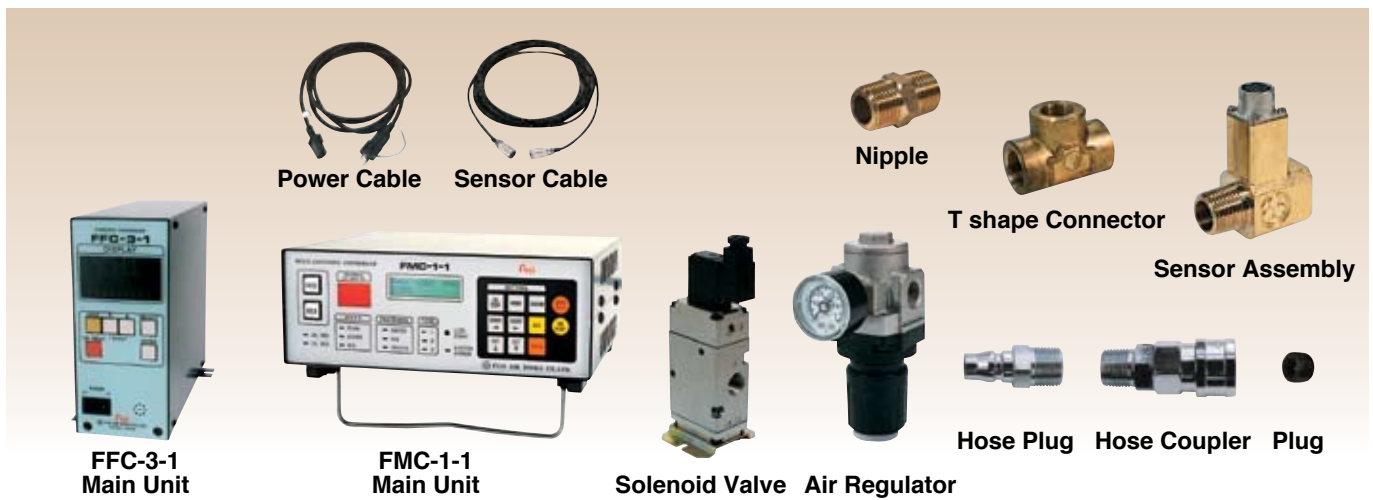

Air Hose Size	AC No.	Description	Quantity required	FMC-1-1-1 FFC-3-1-1	FFC-3-1-6	FMC-1-1-3 FFC-3-1-3	FMC-1-1-4 FFC-3-1-4	FMC-1-1-5 FFC-3-1-5
-	E-025006-00	Main Unit FMC	1	•	•	•	•	•
	E-039006-00	FFC						
	ECO-AC100-3	Power Cable 3m	1	•	•	•	•	•
	E-017024-00	Sensor Assembly	1	•	•	•	•	•
3/8	ECO-3-6	Sensor Cable	1	•	•	•	•	•
	ESV-VP542-5T	Solenoid Valve	1	-	•	-	-	-
	AR3000-3/8	Air Regulator	1	-	•	•	-	-
	JN-1/2x3/8B	Nipple	1	-	-	•	-	-
	ESV-VP742-5	Solenoid Valve	1	-	-	•	-	-
	JN-3/8(B)	Nipple	1	-	•	-	-	-
	M-527	Hose Coupler 1/2"	1	-	•	-	-	-
	M-526	Hose Coupler 3/8"	1	-	•	-	-	-
1/2	M-633	Hose Plug 1/2"	1	-	•	-	-	-
	M-628	Hose Plug 3/8"	1	-	•	-	-	-
	ESV-VP742-5	Solenoid Valve	1	-	-	-	•	-
	AR4000-1/2	Air Regulator	1	-	-	-	•	-
3/4	JN-1/2(B)	Nipple	1	-	-	-	•	-
	ESV-VG342-5	Solenoid Valve	1	-	-	-	-	•
	AR4000-06	Air Regulator	1	-	-	-	-	•
	JN-3/4(B)	Nipple	2	-	-	-	-	•
	JT-060604	T shape Connector	1	-	-	-	-	•
	PL-1/2	Plug	1	-	-	-	-	•

*Each model consists of accessories marked •.

*Make sure to choose the model which can fit the air hose connected to the tool.

FMC PROGRAM

PROGRAM	SPECIFICATIONS			
	PG1	PG2	PG3	PG4
Fastening Control	•	•	•	•
Countdown	•	•	•	•
Data Monitoring	•	•	•	•
Communication		•		•
Printer Output ★			•	•

*Specify the specification when ordering FMC.

HYDRAULIC TORQUE TESTERS

The hydraulic torque testers are designed to satisfy the need for accurate torque checking and adjustment of shut-off type pulse wrenches and screwdrivers.



Features

- Bright LED digital display for easy reading in poor light conditions.
- Easy operation and high precision.
- Joint rate setting (soft joint to hard joint) is applicable.

Model	Power sources	Mass		Testing Bolt Size	Measuring Range	
		kg	lb		N · m	kgf · m
FJT-5-1	AC100V	10.0	22.0	M4	1.6~3.2	0.16~0.32
FJT-5A-1	AC110V				3.2~5.4	0.32~0.54
FJT-5B-1	AC220V					
FJT-5C-1	AC240V	11.5	25.3	M6	5.4~14.7	0.54~1.47
FJT-10-1	AC100V			M8	14.7~31.4	1.47~3.14
FJT-10A-1	AC110V					
FJT-10B-1	AC220V	21.7	47.7	M10	31.4~53.9	3.14~5.39
FJT-10C-1	AC240V					
FJT-16-1	AC100V			M12	53.9~88.2	5.39~8.82
FJT-16A-1	AC110V	M14	88.2~149.0	8.82~14.90		
FJT-16B-1	AC220V					
FJT-16C-1	AC240V	M16	149.0~190.0	14.90~19.00		

DIGITAL TORQUE TESTER

FDT-2-1 is the ideal Digital Torque Tester for initial setting, periodical torque checking and adjustment of pulse wrenches, angle nutrunners, and hand torque wrenches. Equipped with interfaces and terminals, the FDT-2-1 can communicate with personal computers, printers, data recorders and other peripheral instruments. The Fuji FDT-2-1 is ideal technical assistant in your laboratory and tool-control facility.

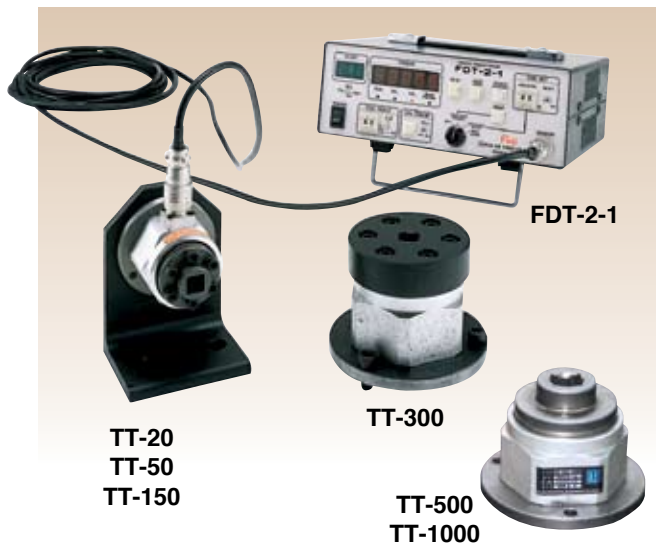

Features

- High accuracy within $\pm 0.5\%$ of full scale
- Wide measuring range up to 9,900 N·m, 1,000 kgf·m, 7,230 ft·lb
- Bright LED Display for quick and accurate reading
- Built-in Blow Counter for easy blow number adjustment
- 3 measuring units : N·m, kgf·m and ft·lb can be selected
- Easy Calibration check for circuitry function check of the transducer
- RS232C port is available for communication with PC
- 2 types of printer port (Bit parallel and Centronics) are equipped.
- 2 types of Auto Pulse Analysis are equipped.
 - AVL Average torque
 - PEAK Peak torque

DIGITAL TORQUE TESTER

Model	Dimensions						Mass		Power Sources	Power Consumption
	Width		Height		Depth		kg	lb	V	W
	mm	in	mm	in	mm	in				
FDT-2-1	258	10 11/64	116	4 37/64	243	9 37/64	3.7	8.1	AC100~240	12

Accessories



Socket



Hex Driver Bit

No.	Size	Model
	in x in	
1333	F3/8 X M1/2	TT-150

Parts No.	Size	Model
	in x mm	
Y-004558-01	1/2 x 6.35	TT-150
Y-003558-00	3/8 x 6.35	TT-20, 50

TORQUE TRANSDUCERS

Model	Measuring Range		Square Size		Applicable models
	N · m	kgf · m	mm	in	
TT-20	2.0~20.0	0.2~2.0	9.5	3/8	FPW-110, 110S FPW-110SD, 330SD, 400SD use with driver adapter, Y-003558-00
TT-50	5.0~50.0	0.5~5.0	9.5	3/8	FPW-330~550, 330S~550S FPW-440SD~660SD use with driver adapter, Y-003558-00
TT-150	10.0~150.0	1.0~15.0	9.5	3/8	FPW-660~770, 660S~770S use with 3/8 SQ adapter, 1333
			12.7	1/2	FPW-660D~770D, 660SD~770SD use with driver adapter, Y-004558-01
TT-300	20.0~300.0	2.0~30.0	12.7	1/2	FPW-1110, 1330
TT-500	200.0~500.0	20.0~50.0	19.0	3/4	FPW-1660-1
TT-1000	400.0~1000	40.0~100.0	19.0	3/4	FPW-2220S-1
			25.4	1	Large tools in torque range up to 1000 N·m

OIL FILLER

The Fuji oil filler is the ideal, and indispensable, equipment required for maintenance and repair of pulse wrenches. By connecting a conventional air supply to the handle valve, the oil filler makes re-filling the pulse unit assembly quick and easy.

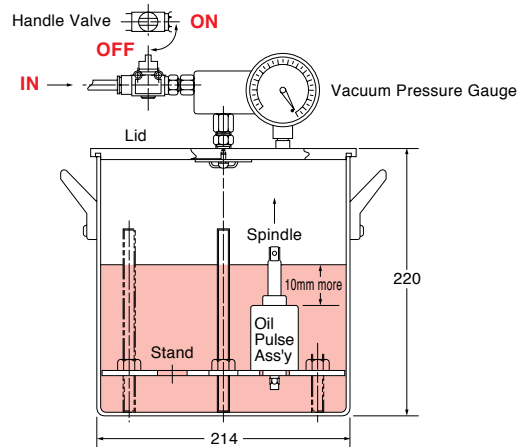

PORTABLE DIGITAL TACHOMETER

The Fuji digital tachometer is ideal for the strict quality control of rotary tools. Accurate rotational speed tests are measured easily by utilising magnetism allowing the sensor to determine the rotational speed.

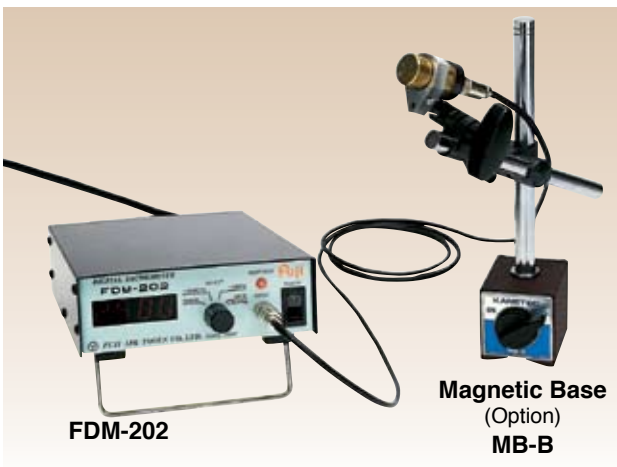

Features

- Bright LED digital indication eliminates operator's errors.
- Non-contact measuring for safe and easy measurement.
- Wide measuring range.
- Quick response for quick measurement.

Model	Dimensions						Mass		Measuring Range	Response	Measuring Method	Indication	Power Source	
	Width		Height		Depth		kg	lb					V	Hz
FDM-202	mm	in	mm	in	mm	in	1.1	2.4	10-999,900	6	Non-Contact Type Magnetic Sensor	LED	AC100~240	50/60

HOW TO MAGNETIZE

Magnetic Induction method is used for this tachometer. Be sure to magnetize the revolving part of a tool with the magnet provided so that a pair of N and S poles may be made.

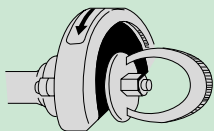

When magnetizing a flat part, be sure to magnetize so that N and S poles may be made at the same time.

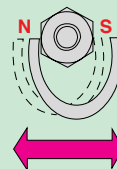
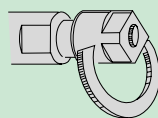

When magnetizing a hexagonal part, a square part, a round part, etc., be sure to magnetize so that N and S poles may be made proportionally.

HOW TO MEASURE

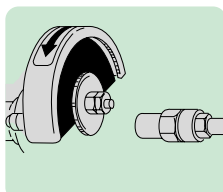

Straight Grinder (Spindle)

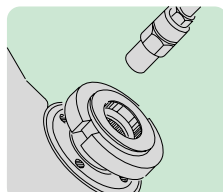

Angle Grinder (Wheel Flange A)

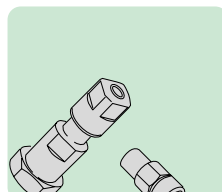

Die Grinder (Collet Chuck)

Electronic Torque Control Pulse

ELECTRONIC TORQUE CONTROL PULSE WRENCHES

The Fuji "F1-shut" is the world's first electric torque control pulse wrench. The dynamic torque is controlled by an integrated microprocessor which senses hydraulic pressure through the built-in transducer. The FET Series is available in two versions; FET-777~1333 are equipped with a shut-off valve and LCD monitoring display on-board; the compact and lighter models FET-33~133 offer these features externally. Both types can be connected to Fuji original network "FV-NET" enabling to be controlled by connected computer, from torque settings through verification and recording.



Pistol Grip Models

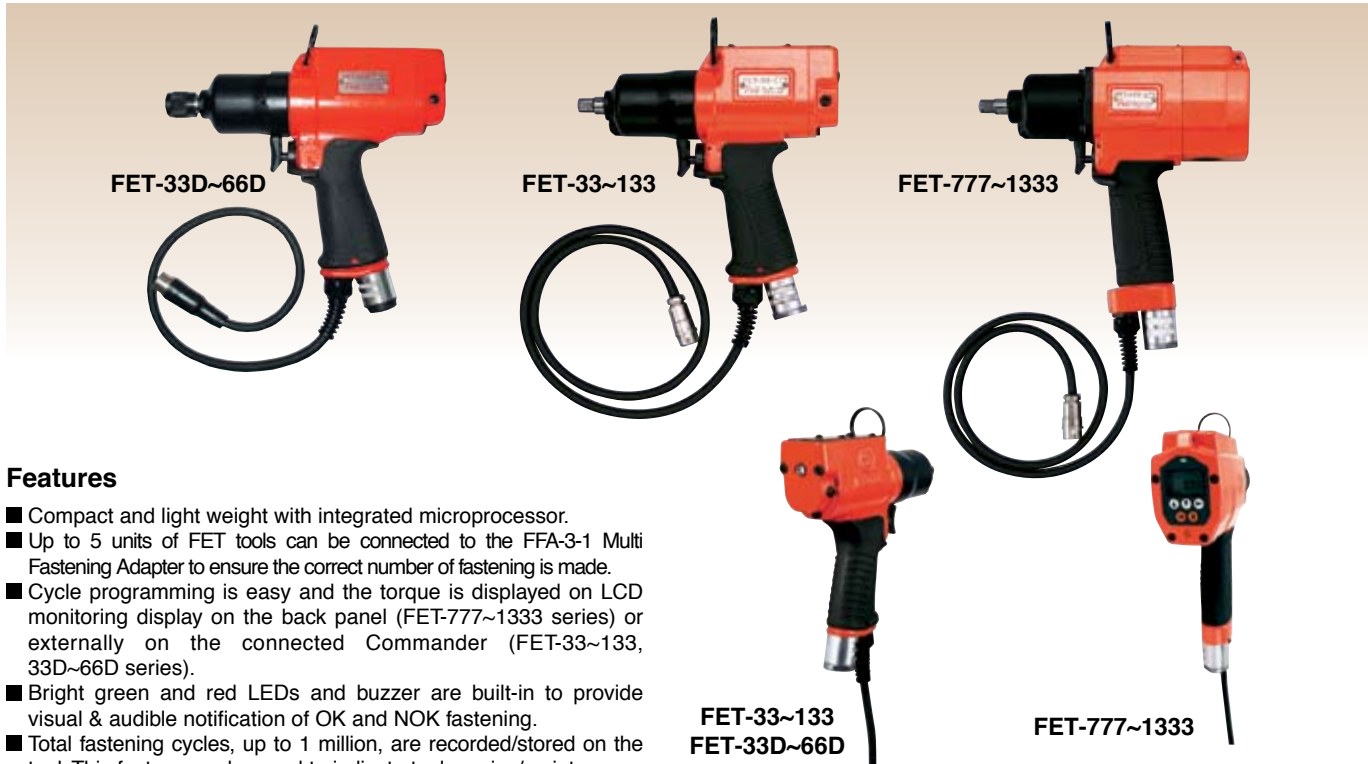

Features

- Compact and light weight with integrated microprocessor.
- Up to 5 units of FET tools can be connected to the FFA-3-1 Multi Fastening Adapter to ensure the correct number of fastening is made.
- Cycle programming is easy and the torque is displayed on LCD monitoring display on the back panel (FET-777~1333 series) or externally on the connected Commander (FET-33~133, 33D~66D series).
- Bright green and red LEDs and buzzer are built-in to provide visual & audible notification of OK and NOK fastening.
- Total fastening cycles, up to 1 million, are recorded/stored on the tool. This feature can be used to indicate tool service/maintenance intervals as required.
- Up to 4,000 sets of fastening data can be stored in the tool and simultaneous data transmission to personal computer or printer is possible.
- Equipped RS485 port provide bi-directional and high-speed communication with personal computers through FV-NET network for overall assembly line control.

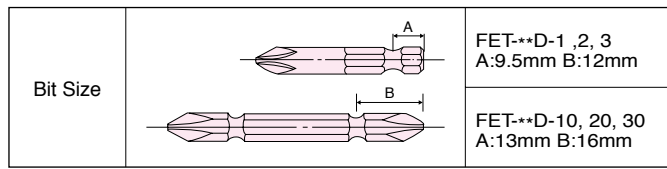

Model	Bolt Size	Recommended Torque Range			Rotational Frequency	Bit Shank Square Drive Size		Overall Length (without socket)		Mass (without socket)		Air Consumption (at Load)	Air Hose Size		
		mm	N · m	kgf · m		ft · lb	mm	in	mm	in	kg		lb	m ³ /min	ft ³ /min
Square Drive Type															
FET-33-1	M4~M6	8~15	0.8~1.5	5.9~11.1	6,000	6.35	1/4	181	7 1/8	1.25	2.8	0.35	12.3	6.3	1/4
FET-44-3	M4~M6	15~25	1.5~2.6	11.1~18.4	6,300	9.5	3/8	181	7 9/64	1.25	2.8	0.40	14.1	6.3	1/4
FET-55-3	M6~M8	27~44	2.8~4.5	19.9~32.5	5,500	9.5	3/8	181	7 9/64	1.25	2.8	0.40	14.1	6.3	1/4
FET-66-3	M6~M8	34~54	3.5~5.5	25.1~39.8	5,300	9.5	3/8	193	7 39/64	1.35	3.0	0.50	17.7	9.5	3/8
FET-77-1	M8	44~76	4.5~7.8	32.5~56.1	6,300	9.5	3/8	188	7 13/32	1.65	3.6	0.50	17.7	9.5	3/8
FET-88-4	M8~M10	49~93	5.0~9.5	36.1~68.6	5,500	12.7	1/2	203	8 1/64	1.9	4.2	0.55	19.4	9.5	3/8
FET-99-2	M10	64~113	6.5~11.5	47.2~83.3	4,800	12.7	1/2	202	7 61/64	2.2	4.9	0.60	21.2	9.5	3/8
FET-111-2	M10~M12	83~132	8.5~13.5	61.2~97.4	4,800	12.7	1/2	215	8 15/32	2.4	5.3	0.60	21.2	9.5	3/8
FET-133-2	M12~M14	127~196	13.0~20.0	93.7~144.6	3,800	12.7	1/2	230	9 5/64	3.0	6.6	0.65	23.0	9.5	3/8
Square Drive Type with LCD Display															
FET-777-1	M8	44~76	4.5~7.8	32.5~56.1	6,300	9.5	3/8	201	7 59/32	1.9	4.2	0.50	17.7	9.5	3/8
FET-888-4	M8~M10	49~93	5.0~9.5	36.1~68.6	5,500	12.7	1/2	216	8 33/64	1.9	4.2	0.55	19.4	9.5	3/8
FET-999-2	M10	64~113	6.5~11.5	47.2~83.3	4,800	12.7	1/2	220	8 43/64	2.4	5.3	0.60	21.2	9.5	3/8
FET-1111-2	M10~M12	83~132	8.5~13.5	61.2~97.4	4,800	12.7	1/2	222	8 3/4	2.6	5.7	0.60	21.2	9.5	3/8
FET-1333-2	M12~M14	127~196	13.0~20.0	93.7~144.6	3,800	12.7	1/2	234	9 7/32	3.4	7.5	0.65	23.0	9.5	3/8
Bit Shank Type															
FET-33D-1	M4~M6	8~15	0.8~1.5	5.9~11.1	6,000	6.35	1/4	181	7 1/8	1.25	2.8	0.35	12.3	6.3	1/4
FET-44D-3	M4~M6	10~20	1.0~2.0	7.4~14.8	6,300	6.35	1/4	181	7 9/64	1.25	2.8	0.40	14.1	6.3	1/4
FET-55D-3	M6~M8	20~34	2.0~3.5	14.8~25.1	5,500	6.35	1/4	181	7 9/64	1.25	2.8	0.40	14.1	6.3	1/4
FET-66D-3	M6~M8	25~37	2.6~3.8	18.4~27.3	5,300	6.35	1/4	193	7 39/64	1.35	3.0	0.50	17.7	9.5	3/8
FET-33D-10	M4~M6	8~15	0.8~1.5	5.9~11.1	6,000	6.35	1/4	181	7 1/8	1.25	2.8	0.35	12.3	6.3	1/4
FET-44D-30	M4~M6	10~20	1.0~2.0	7.4~14.8	6,300	6.35	1/4	181	7 9/64	1.25	2.8	0.40	14.1	6.3	1/4
FET-55D-30	M6~M8	20~34	2.0~3.5	14.8~25.1	5,500	6.35	1/4	181	7 9/64	1.25	2.8	0.40	14.1	6.3	1/4
FET-66D-30	M6~M8	25~37	2.6~3.8	18.4~27.3	5,300	6.35	1/4	193	7 39/64	1.35	3.0	0.50	17.7	9.5	3/8

*Air Inlet Thread Size: PT or NPT 1/4".

VERSATILE APPLICATIONS

1 Hard-copy recording and fastening bolt number auditing

- 1) Direct print-out of fastening data is possible through optional printer interface.
- 2) Fastening bolt number audit can be made with tamperproof devices connected to interface unit.

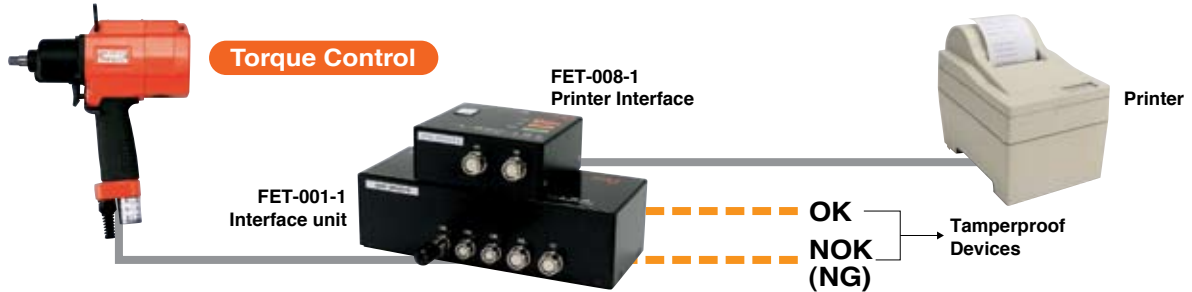

2 Fastening bolt number audit with personal computer and FFA-3-1

Fuji FFA-3-1 is Multi-Fastening Adapter equipped RS232C and RS485 ports. Fastening bolt number audit is made through either RS232C and RS485 network with personal or host computers. A unit of FFA-3-1 can manage up to 5 units of Electronic Torque Control Pulse Wrenches.

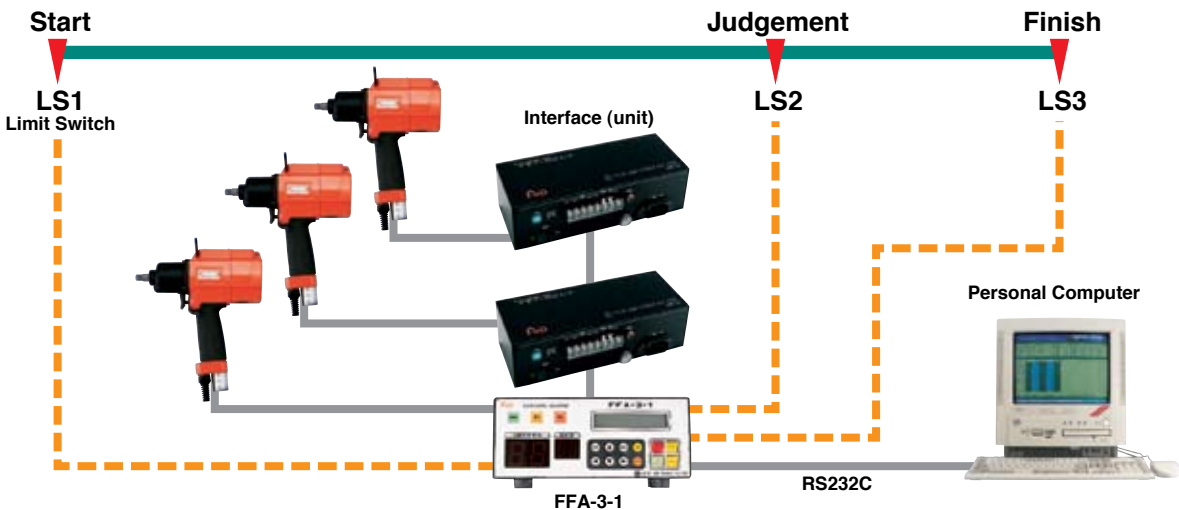

3 Overall assembly line supervision with "FV-NET" Network

Overall supervision of assembly lines is possible with Fuji unique communication network "FV-NET" which can accommodate up to 100 units of Electronic Torque Control Pulse Wrenches and 20 units of FFA-3-1 within a distance of 1 kilometer. RS485 port equipped to the tool and FFA-3-1 are suitable for high-speed and bi-directional network communication.

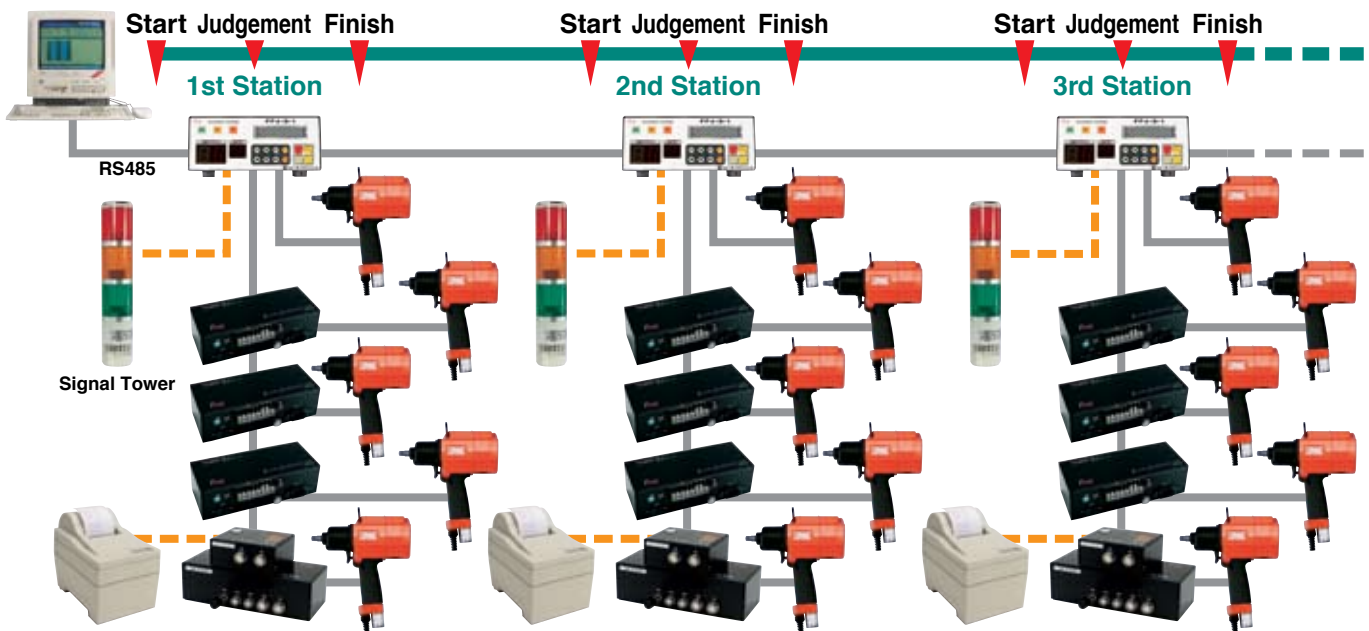

Electronic Torque Control Pulse

ACCESSORIES INCLUDED IN FET SERIES KIT

Following accessories are necessary to complete FET series as a kit. Each kit consists of components marked and complete kit can be ordered by adding "KIT" at the end of model number.
Example; FET-55-2 → FET-55-2 KIT



Air Hose Size	AC No.	Description	FET-33~77 33D~66D	FET-88~133	FET-777	FET-888~1333
-	FET-001-1	Interface Unit	•	•	•	•
	ECO-AC100-2	Power Cable 2m	•	•	•	•
	E-032070-00	Noise Filter	•	•	•	•
-	FET-003-1	Sensor Cable 3m	•(2)	•(2)	•(1)	•(1)
	FET-002-1	Commander	•	•	-	-
3/8	AR3000-3/8	Air Regulator 3/8"	•	-	•	-
	ESV-VP542-B	12V Solenoid Valve 3/8"	•	-	-	-
	JN-3/8(B)	Nipple 3/8"	•	-	-	-
	M-526	Hose Coupler 3/8"	•	-	•	-
	M-628	Hose Plug 3/8"	•	-	•	-
1/2	AR4000-1/2	Air Regulator 1/2"	-	-	-	•
	ESV-VP742-B	12V Solenoid Valve 1/2"	-	•	-	-
	JN-1/2(B)	Nipple 1/2"	-	•	-	-
	M-527	Hose Coupler 1/2"	-	•	-	•
	M-629	Hose Plug 1/2"	-	•	-	•

INTERFACE UNIT / PRINTER INTERFACE UNIT

AC No.	Dimensions			Mass kg	Power Sources		Power Consumption VA
	Width mm	Height mm	Depth mm		V	Hz	
FET-001-1	200	57.5	78.5	1.0	100~240	50/60	3
FET-008-1	100	40.0	80.0	0.4	12	DC	0.72

*Fastening data can be printed out with FET-008-1 printer interface unit (option) and printer (option).
Contact us for suitable printer selection.



Interface Unit
FET-001-1

Printer Interface Unit
FET-008-1
(OPTION)

TWIN HOSE

Model	Diameter(mm)	3m	5m	6m	10m	15m
FET-33~66 FET-33D~66D	6.5	FET007-6.5-3	FET007-6.5-5	FET007-6.5-6	FET007-6.510	FET007-6.515
FET-77~88 FET-777~888	8	FET007-8-3	FET007-8-5	FET007-8-6	FET007-8-10	FET007-8-15
FET-99~133 FET-999~1333	11	FET007-11-3	FET007-11-5	FET007-11-6	FET007-11-10	FET007-11-15

DATA LOAD AND FV-NET WORK PROGRAM

AC No.	Description	Hard CPU Board	Software (Floppy)		
			Basic	Data Load	FV-NET
FET-004-1-2	CPU BOARD & FLOPPY	•	•	•	-
FET-004-2-2	CPU BOARD & FLOPPY	•	•	•	•

*Please contact nearby agent for FV-NET PROGRAM



CPU BOARD
(OPTION)

AC No.	Description
FET-006-20	FV-NET CABLE 20M

*FV-NET cables can be supplied with different lengths.
Please specify the cable lengths in ordering.

FV-NET SYSTEM

To utilize FV-NET communication network system with personal computer, CPU board and software have to be installed and connect FET-001-1 interface unit by FV-NET cable with PC.

PULSE WRENCHES SHUT-OFF TYPE PAT.P

"FPT Series" are provided with Fuji patented original shut-off control mechanism having a dual chamber motor and two blade pulsing mechanism. It is designed for giving high torque at low speed, which gives the best characteristics for fast, reliable and accurate tightening. FPT series contribute to high productivity, quality improvement, working environment improvement, and operator fatigue minimization in various industries.

SQUARE DRIVE TYPE

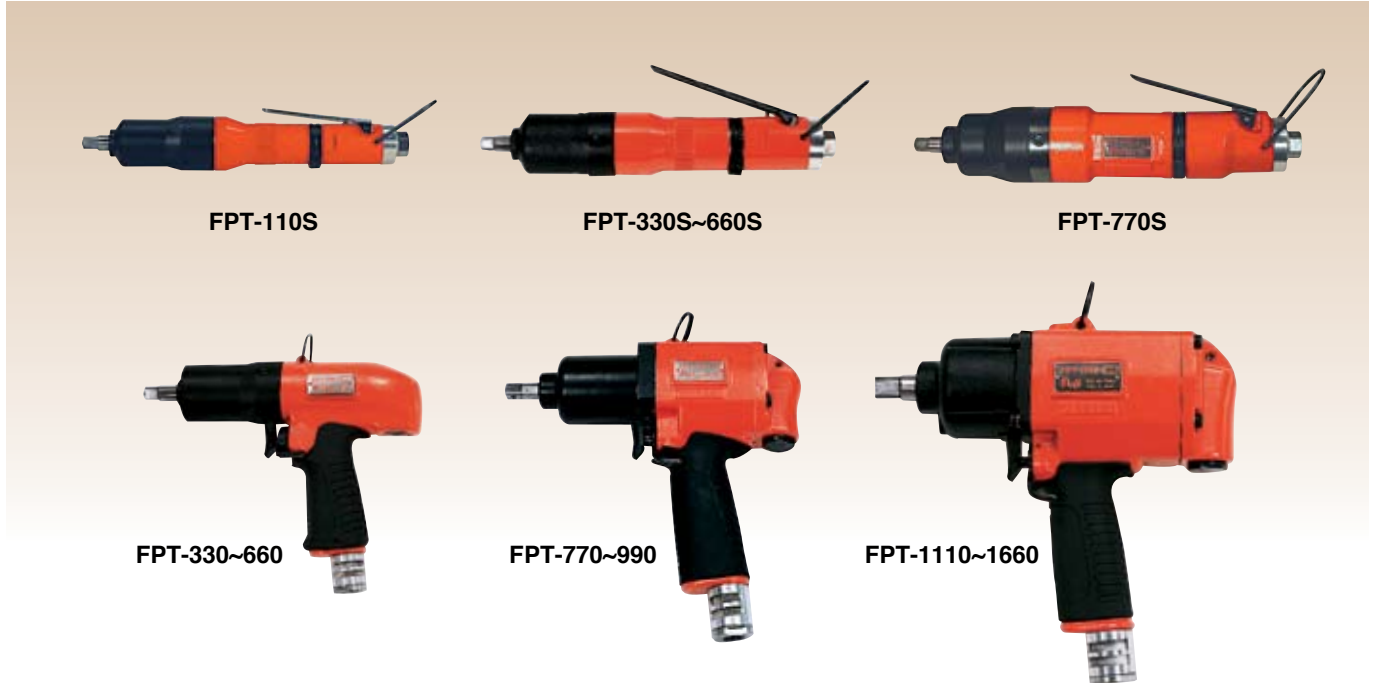

Models to be operated at air pressure 0.5MPa to 0.63MPa

Model	Bolt Size	Recommended Torque Range			Rotational Frequency	Square Drive Size		Overall Length		Mass (without socket)		Air Consumption (at Load)	
		mm	N · m	kgf · m		ft · lb	mm	in	mm	in	kg	lb	m ³ /min
Straight Models													
FPT-110S-1	M4~M5	4~7	0.4~0.7	3.0~5.2	4,500	9.5	3/8	236.5	9 5/16	0.85	1.9	0.20	7.1
FPT-330S-1	M5~M6	6~10	0.6~1.0	4.4~7.4	4,400	9.5	3/8	249	9 13/16	1.1	2.4	0.35	12.3
FPT-440S-1	M5~M6	8~13	0.8~1.3	5.9~9.6	5,000	9.5	3/8	250	9 27/32	1.1	2.4	0.35	12.3
FPT-550S-1	M6~M8	12~20	1.2~2.0	8.9~14.8	5,000	9.5	3/8	250	9 27/32	1.1	2.4	0.35	12.3
FPT-660S-1	M6~M8	20~30	2.0~3.1	14.8~22.1	5,000	9.5	3/8	262	10 21/64	1.1	2.4	0.50	17.6
FPT-770S-1	M8~M10	30~45	3.1~4.6	22.1~33.2	5,500	9.5	3/8	273.5	10 49/64	1.6	3.5	0.45	15.9
Pistol Grip Models													
FPT-110-1	M5~M6	4~7	0.4~0.7	3.0~5.2	6,000	9.5	3/8	194.5	7 21/32	0.95	2.1	0.20	7.1
FPT-330-1	M5~M6	6~11	0.6~1.1	4.4~8.1	6,000	9.5	3/8	198	7 51/64	1.2	2.6	0.39	13.8
FPT-440-1	M6	10~18	1.0~1.8	7.4~13.3	6,700	9.5	3/8	193	7 39/64	1.2	2.6	0.35	12.3
FPT-550-1	M6~M8	15~25	1.5~2.6	11.1~18.4	5,800	9.5	3/8	193	7 39/64	1.2	2.6	0.40	14.1
FPT-660-1	M6~M8	20~35	2.0~3.6	14.8~25.8	5,400	9.5	3/8	202	7 61/64	1.3	2.9	0.40	14.1
FPT-770-1	M8	30~45	3.1~4.6	22.1~33.2	6,300	9.5	3/8	200	7 7/8	1.6	3.5	0.45	15.8
FPT-880-3	M8~M10	40~60	4.1~6.1	29.5~44.3	5,800	12.7	1/2	214	8 7/16	2.0	4.4	0.50	17.6
FPT-990-1	M10	55~80	5.6~8.2	40.6~59.0	4,800	12.7	1/2	215	8 15/32	2.4	5.3	0.55	19.4
FPT-1110-1	M10~M12	75~130	7.7~13.3	55.3~95.9	4,400	12.7	1/2	216	8 1/2	2.6	5.7	0.60	21.1
FPT-1330-1	M12~M14	90~160	9.2~16.3	66.4~118.0	3,600	12.7	1/2	228	8 31/32	3.2	7.0	0.74	26.1
FPT-1660-1	M16~M18	150~210	15.3~21.4	110.6~154.9	2,800	19.0	3/4	266	10 31/64	4.4	9.7	1.2	42.4

*Use all above models at 0.5-0.63 MPa(5.0-6.3 kgf/cm²) air pressure but FPT-110 series at 0.4-0.63 MPa (4.0-6.3 kgf/cm²) air pressure.

*Performance figures are at 0.63 MPa(6.3 kgf/cm²) air pressure. *Air Inlet Thread Size: PT or NPT 1/4", (FPT-1660) PT or NPT 3/8".

*Air Hose Size: (FPT-110S, 330S, 440S, 550S, 110, 330, 440, 550) 6.3mm (1/4"). (660S, 770S, 660~1660) 9.5mm (3/8").

Models to be operated at air pressure 0.4MPa to 0.5MPa

Model	Bolt Size	Recommended Torque Range			Rotational Frequency	Square Drive Size		Overall Length		Mass (without socket)		Air Consumption (at Load)	
		mm	N · m	kgf · m		ft · lb	mm	in	mm	in	kg	lb	m ³ /min
Pistol Grip Models													
FPT-440-1L	M6	10~15	1.0~1.5	7.4~11.1	5,400	9.5	3/8	193	7 39/64	1.2	2.6	0.19	6.7
FPT-550-1L	M6~M8	12~20	1.2~2.0	8.9~14.8	4,900	9.5	3/8	193	7 39/64	1.2	2.6	0.20	7.0
FPT-660-1L	M6~M8	13~28	1.3~2.9	9.6~20.7	4,600	9.5	3/8	202	7 61/64	1.3	2.9	0.20	7.0
FPT-770-1L	M8	28~40	2.9~4.1	20.7~29.5	5,300	9.5	3/8	200	7 7/8	1.6	3.5	0.30	10.5
FPT-880-3L	M8~M10	38~48	3.9~4.9	28.0~35.4	5,200	12.7	1/2	214	8 7/16	2.0	4.4	0.30	10.5
FPT-990-1L	M10	40~60	4.1~6.1	29.5~44.3	4,200	12.7	1/2	215	8 15/32	2.4	5.3	0.33	11.6
FPT-1110-1L	M10~M12	65~100	6.6~10.2	47.9~73.8	3,800	12.7	1/2	216	8 1/2	2.6	5.7	0.37	13.0
FPT-1330-1L	M12	80~130	8.2~13.3	59.0~95.9	3,100	12.7	1/2	228	8 31/32	3.2	7.0	0.48	16.9

*Use all above models at 0.4-0.5 MPa(4.0-5.0 kgf/cm²) air pressure. *Performance figures are at 0.4 MPa(4.0 kgf/cm²) air pressure.

*Air Inlet Thread Size: PT or NPT 1/4". *Air Hose Size: (440, 550) 6.3mm (1/4"). (660~1330) 9.5mm (3/8").

Pulse Wrenches Shut-off Type

BIT SHANK TYPE

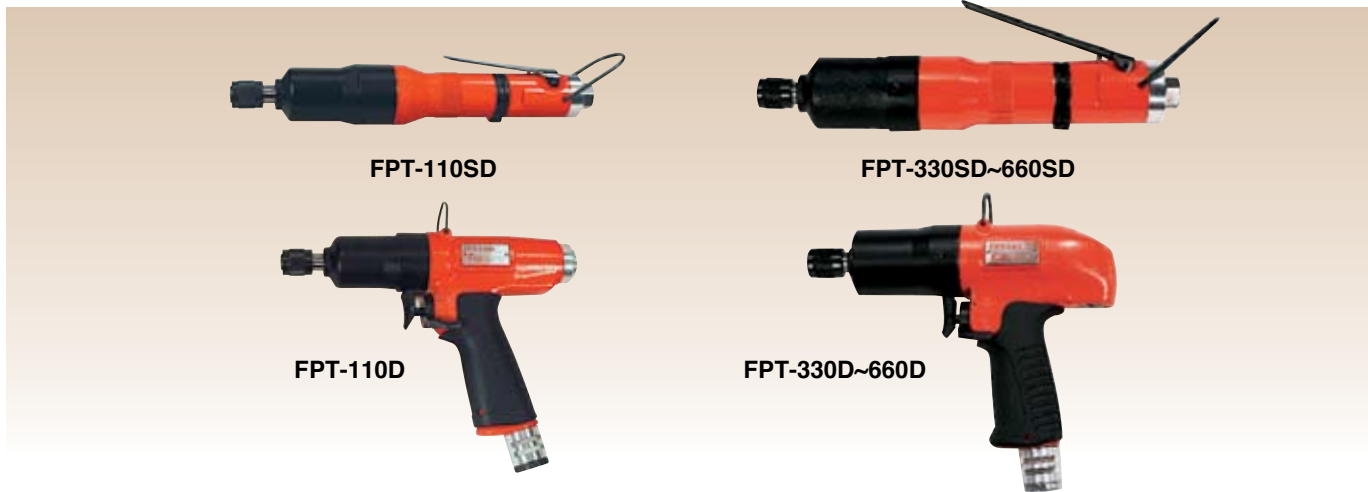

Models to be operated at air pressure 0.5MPa to 0.63MPa

Model	Bolt Size	Recommended Torque Range			Rotational Frequency	Bit Shank Size		Overall Length		Mass (without socket)		Air Consumption (at Load)	
		mm	N · m	kgf · m		ft · lb	mm	in	mm	in	kg	lb	m³/min
Straight Models													
FPT-110SD-1(10)	M4~M5	4~7	0.4~0.7	3.0~5.2	4,500	6.35	1/4	240.0	9 29/64	0.85	1.9	0.20	7.1
FPT-330SD-1(10)	M5~M6	6~10	0.6~1.0	4.4~7.4	4,400	6.35	1/4	249	9 13/16	1.1	2.4	0.35	12.3
FPT-440SD-1(10)	M5~M6	8~13	0.8~1.3	5.9~9.6	5,000	6.35	1/4	251	9 57/64	1.1	2.4	0.35	12.3
FPT-550SD-1(10)	M6~M8	12~20	1.2~2.0	8.9~14.8	5,000	6.35	1/4	251	9 57/64	1.1	2.4	0.35	12.3
FPT-660SD-1(10)	M6~M8	15~28	1.5~2.9	11.1~20.7	5,000	6.35	1/4	262	10 21/64	1.1	2.4	0.50	17.6
Pistol Grip Models													
FPT-110D-1(10)	M5~M6	4~7	0.4~0.7	3.0~5.2	6,000	6.35	1/4	197.5	7 25/32	0.95	2.1	0.20	7.1
FPT-330D-1(10)	M5~M6	6~11	0.6~1.1	4.4~8.1	6,000	6.35	1/4	198	7 51/64	1.2	2.6	0.39	13.8
FPT-440D-1(10)	M6	10~16	1.0~1.6	7.4~11.8	6,700	6.35	1/4	193	7 39/64	1.2	2.6	0.35	12.3
FPT-550D-1(10)	M6~M8	15~20	1.5~2.0	11.1~14.8	5,800	6.35	1/4	193	7 39/64	1.2	2.6	0.40	14.1
FPT-660D-1(10)	M6~M8	17~25	1.7~2.6	12.5~18.4	5,400	6.35	1/4	202	7 61/64	1.3	2.9	0.40	14.1

*Use all above models at 0.5-0.63 MPa(5.0-6.3 kgf/cm²) air pressure but FPT-110 series at 0.4-0.63 MPa (4.0-6.3 kgf/cm²) air pressure.

*Performance figures are at 0.63 MPa(6.3 kgf/cm²) air pressure. *Air Inlet Thread Size: PT or NPT 1/4".

*Air Hose Size: (FPT-110SD, 330SD, 440SD, 550SD, 110D, 330D, 440D, 550D) 6.3mm (1/4"). (660SD, 660D) 9.5mm (3/8").

Models to be operated at air pressure 0.4MPa to 0.5MPa

Model	Bolt Size	Recommended Torque Range			Rotational Frequency	Bit Shank Size		Overall Length		Mass (without socket)		Air Consumption (at Load)	
		mm	N · m	kgf · m		ft · lb	mm	in	mm	in	kg	lb	m³/min
Pistol Grip Models													
FPT-440D-1L(10L)	M6	10~15	1.0~1.5	7.4~11.1	5,400	6.35	1/4	193	7 39/64	1.2	2.6	0.19	6.7
FPT-550D-1L(10L)	M6~M8	15~18	1.5~1.8	11.1~13.3	4,900	6.35	1/4	193	7 39/64	1.2	2.6	0.20	7.0
FPT-660D-1L(10L)	M6~M8	17~23	1.7~2.3	12.5~17.0	4,600	6.35	1/4	202	7 61/64	1.3	2.9	0.20	7.0

*Use all above models at 0.4-0.5 MPa(4.0-5.0 kgf/cm²) air pressure. *Performance figures are at 0.4 MPa(4.0 kgf/cm²) air pressure.

*Air Inlet Thread Size: PT or NPT 1/4". *Air Hose Size: (440D, 550D) 6.3mm (1/4"). (660D) 9.5mm (3/8").

SQUARE DRIVE TYPE



Models to be operated at air pressure 0.5MPa to 0.63MPa

Model	Bolt Size	Recommended Torque Range			Rotational Frequency	Square Drive Size		Overall Length		Mass (without socket)		Air Consumption (at Load)	
		mm	N · m	kgf · m		ft · lb	mm	in	mm	in	kg	lb	m³/min
Angle Head Models													
FPT-440SC-1	M5~M6	6~11	0.6~1.1	4.4~8.1	4,500	9.5	3/8	280	11 1/32	1.46	3.2	0.35	12.4
FPT-550SC-1	M6	10~17	1.0~1.7	7.4~12.5	4,800	9.5	3/8	280	11 1/32	1.46	3.2	0.35	12.4
FPT-660SC-1	M6~M8	15~25	1.5~2.6	11.1~18.4	4,700	9.5	3/8	292	11 1/2	1.54	3.4	0.5	17.7
FPT-770SC-1	M8	20~35	2.0~3.6	14.8~25.8	5,500	9.5	3/8	306	12 3/64	2.3	5.1	0.45	15.9

*Air Inlet Thread Size: PT or NPT 1/4". *Air Hose Size: 6.3mm (1/4"). (660SC, 770SC) 9.5mm (3/8").

Bit Size		FPT-***SD-1, ***D-1,1L A:9.5mm B:12mm
		FPT-***SD-10, ***D-10,10L A:13mm B:16mm

GEARED PULSE WRENCHES SHUT-OFF TYPE

The Fuji Geared Pulse Wrenches Shut-Off type provides high power in combination with low noise and vibration through the Dual Chamber Air Motor & Gear-drive angle head.

The ergonomic design reduces the reaction forces experienced by the operator throughout the torque range.



FPT-770G-1

FPT-770SCG-1

Models to be operated at air pressure 0.5MPa to 0.63MPa

Model	Bolt Size	Recommended Torque Range			Rotational Frequency	Socket Hex Size		Overall Length		Mass		Air Consumption (at Load)		Air Hose Size	
	mm	N · m	kgf · m	ft · lb	min ⁻¹	mm	in	mm	in	kg	lb	m ³ /min	ft ³ /min	mm	in
FPT-770G-1	M8	20~30	2.0~3.1	14.8~22.1	8,100	12	15/32	202	7 61/64	2.0	4.4	0.45	15.9	9.5	3/8
FPT-770SCG-1	M6	17~24	1.7~2.4	12.5~17.7	6,400	12	15/32	378	14 7/8	2.6	5.7	0.45	15.9	9.5	3/8

*Air Inlet Thread Size: PT or NPT 1/4".

Models to be operated at air pressure 0.4MPa to 0.5MPa

Model	Bolt Size	Recommended Torque Range			Rotational Frequency	Socket Hex Size		Overall Length		Mass		Air Consumption (at Load)		Air Hose Size	
	mm	N · m	kgf · m	ft · lb	min ⁻¹	mm	in	mm	in	kg	lb	m ³ /min	ft ³ /min	mm	in
FPT-770G-1L	M6~M8	12~20	1.2~2.0	8.9~14.8	6,500	12	15/32	202	7 61/64	2.0	4.4	0.30	10.6	9.5	3/8

*Air Inlet Thread Size: PT or NPT 1/4".

Custom-made Products

LV Type



For tool's upside-down use application, extended lever handle is attached to the trigger of pistol grip models. Specify it as "LV Type" in ordering. Models larger than FPT-770 are available as "LV type".



Sensing Port (Countdown) Type



To mate with the bolt count-down devices, all FPT tools as well as other non-shut-off pulse tools can be easily changed to the air pressure-sensing type by inserting a tube into the air supply passage near to the air motor. Specify it as "CD Type" in ordering.

Pulse Wrenches

PULSE WRENCHES

Featured with dual chamber air motor, FPW series pulse wrenches are designed to generate higher torque and yet reducing vibration, torque reaction and noise levels. Combined with two blade impulsing mechanism, 9-blade dual chamber motor creates about 50% higher power-to-weight ratio than our former series of the same physical size. The reduction of vibration and torque reaction helps reduce operator fatigue and other problems associated with repeated vibration or impact motion.

SQUARE DRIVE TYPE



Model	Bolt Size	Recommended Torque Range			Rotational Frequency	Square Drive Size		Overall Length (without socket)		Mass (without socket)		Air Consumption (at Load)		Air Hose Size	
		mm	N · m	kgf · m		ft · lb	mm	in	mm	in	kg	lb	m ³ /min	ft ³ /min	mm
Pistol Grip Models															
FPW-110-1	M4~M5	7.5~13 (2~7.5)	0.8~1.3 (0.2~0.8)	5.5~9.6 (1.4~5.5)	4,500	9.5	3/8	143	5 41/64	0.75	1.7	0.20	7.1	6.3	1/4
FPW-330-1	M5	18~27	1.8~2.8	13.3~19.9	6,000	9.5	3/8	151	5 15/16	0.95	2.1	0.35	12.4	6.3	1/4
FPW-440-3	M4~M6	25~37	2.6~3.8	18.4~27.3	6,800	9.5	3/8	151	5 15/16	0.95	2.1	0.40	14.1	6.3	1/4
FPW-550-3	M6~M8	27~44	2.8~4.5	19.9~32.5	6,100	9.5	3/8	151	5 15/16	0.95	2.1	0.40	14.1	6.3	1/4
FPW-660-4	M6~M8	34~54	3.5~5.5	25.1~39.8	6,400	9.5	3/8	163	6 27/64	1.00	2.2	0.50	17.7	9.5	3/8
FPW-770-3	M8	44~76	4.5~7.8	32.5~56.1	6,300	9.5	3/8	175	6 57/64	1.45	3.2	0.50	17.7	9.5	3/8
FPW-880-6	M8~M10	49~93	5~9.5	36.1~68.6	5,500	12.7	1/2	190	7 31/64	1.75	3.9	0.55	19.4	9.5	3/8
FPW-990-3	M10	64~113	6.5~11.5	47.2~83.3	4,800	12.7	1/2	190	7 31/64	2.00	4.4	0.60	21.2	9.5	3/8
FPW-1110-1	M10~M12	83~132	8.5~13.5	61.2~97.4	4,800	12.7	1/2	193	7 39/64	2.20	4.9	0.60	21.2	9.5	3/8
FPW-1330-1	M12~M14	127~196	13~20	93.7~144.6	3,800	12.7	1/2	206	8 1/8	2.90	6.4	0.65	23.0	9.5	3/8
FPW-1660-1	M16~M18	160~270	16.3~27.5	118~199.1	3,000	19.0	3/4	243	9 37/64	3.80	8.4	1.20	42.4	9.5	3/8

*Air Inlet Thread Size: PT or NPT 1/4", (FPW-1660)PT or NPT 3/8".

*Figures in () can be obtained at the position of "L" mark on the regulator knob, but for another, at "H" mark.

BIT SHANK TYPE



Model	Bolt Size	Recommended Torque Range			Rotational Frequency	Bit Shank Size		Overall Length (without socket)		Mass (without socket)		Air Consumption (at Load)		Air Hose Size	
		mm	N · m	kgf · m		ft · lb	mm	in	mm	in	kg	lb	m ³ /min	ft ³ /min	mm
Pistol Grip Models															
FPW-110D-1	M4~M5	7~11 (2~7)	0.7~1.1 (0.2~0.7)	5.2~8.1 (1.4~5.1)	4,500	6.35	1/4	149	5 7/8	0.76	1.7	0.20	7.1	6.3	1/4
FPW-110D-10	M4~M5	7~11	0.7~1.1	5.2~8.1	4,500	6.35	1/4	149	5 7/8	0.76	1.7	0.20	7.1	6.3	1/4
FPW-330D-1	M5	13~20	1.3~2.0	9.6~14.8	6,000	6.35	1/4	151	5 15/16	0.95	2.1	0.35	12.4	6.3	1/4
FPW-330D-10	M5	13~20	1.3~2.0	9.6~14.8	6,000	6.35	1/4	151	5 15/16	0.95	2.1	0.35	12.4	6.3	1/4
FPW-440D-3	M4~M6	18~29	1.8~3.0	13.3~21.4	6,800	6.35	1/4	151	5 15/16	0.95	2.1	0.40	14.1	6.3	1/4
FPW-440D-30	M4~M6	18~29	1.8~3.0	13.3~21.4	6,800	6.35	1/4	151	5 15/16	0.95	2.1	0.40	14.1	6.3	1/4
FPW-550D-3	M6~M8	20~34	2.0~3.5	14.8~25.1	6,100	6.35	1/4	151	5 15/16	0.95	2.1	0.40	14.1	6.3	1/4
FPW-550D-30	M6~M8	20~34	2.0~3.5	14.8~25.1	6,100	6.35	1/4	151	5 15/16	0.95	2.1	0.40	14.1	6.3	1/4
FPW-660D-4	M6~M8	25~37	2.6~3.8	18.4~27.3	6,400	6.35	1/4	163	6 27/64	1.00	2.2	0.50	17.7	9.5	3/8
FPW-660D-40	M6~M8	25~37	2.6~3.8	18.4~27.3	6,400	6.35	1/4	163	6 27/64	1.00	2.2	0.50	17.7	9.5	3/8
FPW-770D-3	M8	34~47	3.5~4.8	25.1~34.7	6,300	6.35	1/4	174	6 27/32	1.45	3.2	0.50	17.7	9.5	3/8
FPW-770D-30	M8	34~47	3.5~4.8	25.1~34.7	6,300	6.35	1/4	174	6 27/32	1.45	3.2	0.50	17.7	9.5	3/8

*Air Inlet Thread Size: PT or NPT 1/4".

*Figures in () can be obtained at the position of "L" mark on the regulator knob, but for another, at "H" mark.

SQUARE DRIVE TYPE

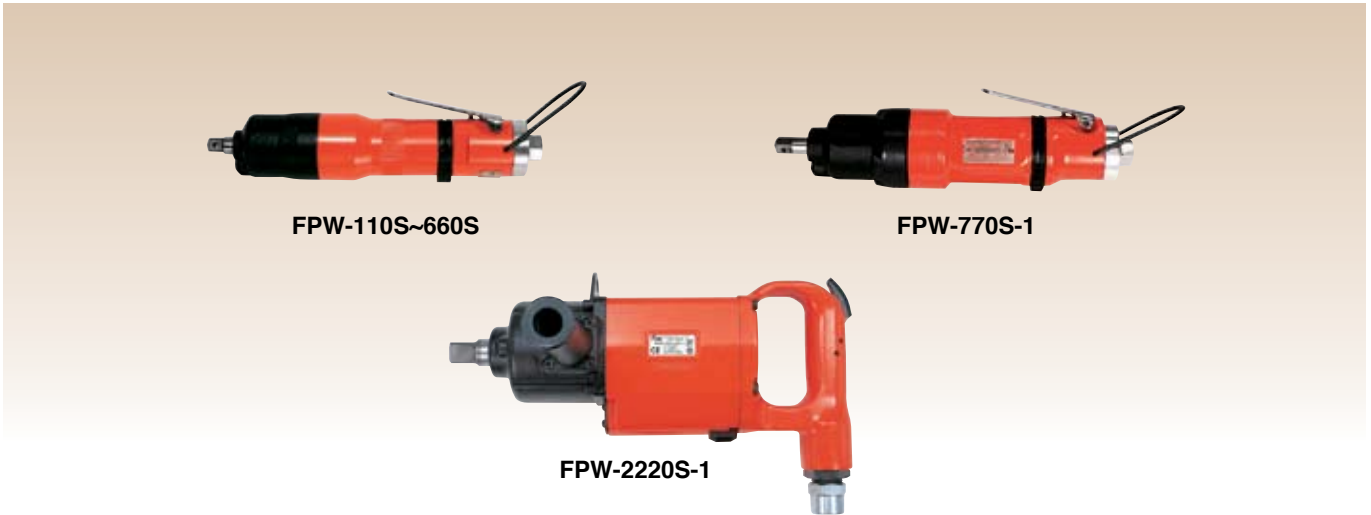

Model	Bolt Size	Recommended Torque Range			Rotational Frequency	Square Drive Size		Overall Length (without socket)		Mass (without socket)		Air Consumption (at Load)		Air Hose Size	
		mm	N · m	kgf · m		ft · lb	mm	in	mm	in	kg	lb	m ³ /min	ft ³ /min	mm
Straight Models															
FPW-110S-1	M4	2~7.5	0.2~0.8	1.5~5.5	3,200	9.5	3/8	218	8 19/32	0.65	1.4	0.20	7.1	6.3	1/4
FPW-330S-1	M5	13~22	1.3~2.2	9.6~16.2	4,400	9.5	3/8	226	8 57/64	0.87	1.9	0.30	10.6	6.3	1/4
FPW-440S-1	M4~M6	20~34	2.0~3.5	14.8~25.1	5,500	9.5	3/8	226	8 57/64	0.87	1.9	0.35	12.4	6.3	1/4
FPW-550S-1	M6~M8	27~44	2.8~4.5	19.9~32.5	5,700	9.5	3/8	226	8 57/64	0.87	1.9	0.37	13.1	6.3	1/4
FPW-660S-1	M6~M8	34~54	3.5~5.5	25.1~39.8	5,800	9.5	3/8	238	9 3/8	0.95	2.1	0.50	17.7	9.5	3/8
FPW-770S-1	M8	44~76	4.5~7.8	32.5~56.1	6,300	9.5	3/8	240	9 7/16	1.25	2.7	0.50	17.7	9.5	3/8
FPW-2220S-1	M18~M20	300~500	30.6~51.0	221.3~368.8	2,500	19.0	3/4	350	10 13/16	7.00	15.4	1.30	45.9	12.7	1/2



*Air Inlet Thread Size: PT or NPT 1/4", (FPW-2220S)PT or NPT 1/2".

BIT SHANK TYPE

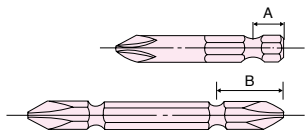

Model	Bolt Size	Recommended Torque Range			Rotational Frequency	Bit Shank Size		Overall Length (without socket)		Mass (without socket)		Air Consumption (at Load)		Air Hose Size	
		mm	N · m	kgf · m		ft · lb	mm	in	mm	in	kg	lb	m ³ /min	ft ³ /min	mm
Straight Models															
FPW-110SD-1	M4	2~7	0.2~0.7	1.5~5.2	3,200	6.35	1/4	224	8 53/64	0.65	1.4	0.20	7.1	6.3	1/4
FPW-110SD-10	M4	2~7	0.2~0.7	1.5~5.2	3,200	6.35	1/4	224	8 53/64	0.65	1.4	0.20	7.1	6.3	1/4
FPW-330SD-1	M5	12~17	1.2~1.7	8.9~12.5	4,400	6.35	1/4	226	8 57/64	0.88	1.9	0.30	10.6	6.3	1/4
FPW-330SD-10	M5	12~17	1.2~1.7	8.9~12.5	4,400	6.35	1/4	226	8 57/64	0.88	1.9	0.30	10.6	6.3	1/4
FPW-440SD-1	M4~M6	15~25	1.5~2.6	11.1~18.4	5,500	6.35	1/4	226	8 57/64	0.88	1.9	0.35	12.4	6.3	1/4
FPW-440SD-10	M4~M6	15~25	1.5~2.6	11.1~18.4	5,500	6.35	1/4	226	8 57/64	0.88	1.9	0.35	12.4	6.3	1/4
FPW-550SD-1	M4~M6	20~34	2.0~3.5	14.8~25.1	5,700	6.35	1/4	226	8 57/64	0.88	1.9	0.37	13.1	6.3	1/4
FPW-550SD-10	M4~M6	20~34	2.0~3.5	14.8~25.1	5,700	6.35	1/4	226	8 57/64	0.88	1.9	0.37	13.1	6.3	1/4
FPW-660SD-1	M6~M8	25~37	2.6~3.8	18.4~27.3	5,800	6.35	1/4	238	9 3/8	0.95	2.1	0.50	17.7	9.5	3/8
FPW-660SD-10	M6~M8	25~37	2.6~3.8	18.4~27.3	5,800	6.35	1/4	238	9 3/8	0.95	2.1	0.50	17.7	9.5	3/8

*Air Inlet Thread Size: PT or NPT 1/4".

Bit Size		FPW-***SD-1, FPW-***D-1,2,3,4 A:9.5mm B:12mm
		FPW-***SD-10, FPW-***D-10,20,30,40 A:13mm B:16mm

Pulse Wrenches

SQUARE DRIVE TYPE



FPW-440SC~660SC

FPW-770SC-1

Model	Bolt Size	Recommended Torque Range			Rotational Frequency	Square Drive Size		Overall Length (without socket)		Mass (without socket)		Air Consumption (at Load)		Air Hose Size	
		mm	N · m	kgf · m		ft · lb	mm	in	mm	in	kg	lb	m ³ /min	ft ³ /min	mm
Angle Head Models															
FPW-440SC-1	M4~M6	13~24	1.3~2.4	9.6~17.7	5,000	9.5	3/8	255	10 3/64	1.28	2.8	0.39	13.8	6.3	1/4
FPW-550SC-1	M6~M8	22~35	2.2~3.6	16.2~25.8	5,500	9.5	3/8	255	10 3/64	1.29	2.8	0.39	13.8	6.3	1/4
FPW-660SC-1	M6~M8	25~43	2.6~4.4	18.4~31.7	5,500	9.5	3/8	267	10 33/64	1.40	3.1	0.48	16.9	9.5	3/8
FPW-770SC-1	M8	33~50	3.4~5.1	24.3~36.9	6,300	9.5	3/8	271	10 43/64	1.70	3.7	0.50	17.7	9.5	3/8

*Air Inlet Thread Size: PT or NPT 1/4".

GEARED PULSE WRENCHES

The Fuji Geared Pulse Wrenches Shut-Off type provides high power in combination with low noise and vibration through the Dual Chamber Air Motor & Gear-drive angle head.

The ergonomic design reduces the reaction forces experienced by the operator throughout the torque range.



FPW-770G-1

FPW-770SCG-1

Model	Bolt Size	Recommended Torque Range			Rotational Frequency	Socket Hex Size		Overall Length		Mass		Air Consumption (at Load)		Air Hose Size	
		mm	N · m	kgf · m		ft · lb	mm	in	mm	in	kg	lb	m ³ /min	ft ³ /min	mm
FPW-770G-1	M6~M8	24~42	2.4~4.3	17.7~31.0	8,100	12	15/32	177	6 31/32	1.7	3.7	0.50	17.7	9.5	3/8
FPW-770SCG-1	M4~M6	21~30	2.1~3.1	15.5~22.1	7,000	12	15/32	343	13 33/64	2.0	4.4	0.50	17.7	9.5	3/8

*Air Inlet Thread Size: PT or NPT 1/4".

"DUAL CHAMBER MOTOR" IMPACT WRENCHES

Fuji Impact Wrenches FW-44~88 have 9 blades dual chamber motor and double clutch type impact mechanism. They are designed for giving high torque at low speed, which give the best characteristics for fast reliable and accurate tightening. These models are provided with two types of lubricant in clutch part, FW-44PA~66PA and FW-44SA~66SA series are with oil (Oil Bath type) which features long service life and FW-44P~88P and FW-44S~66S are with conventional grease. Both series are suitable for self tapping type soft joint.

Pistol Grip Models

9.5mm(3/8")~12.7mm(1/2")



FW-44PA~66PA

FW-88P-1

Model	Bolt Size	Recommended Torque Range			Max. Torque	Rotational Frequency	Square Drive Size		Overall Length (without socket)		Mass (without socket)		Air Consumption (at Load)		Air Hose Size	
		mm	N · m	kgf · m			ft · lb	N · m	min ⁻¹	mm	in	mm	in	kg	lb	m ³ /min
•FW-44PA-2	M5	8~16	0.8~1.6	5.9~11.8	20	6,500	9.5	3/8	131	5 5/32	0.78	1.7	0.60	21.2	6.3	1/4
•FW-66PA-2	M6	14~26	1.4~2.7	10.3~19.2	32	5,000	9.5	3/8	137	5 25/64	0.88	1.9	0.48	16.9	6.3	1/4
FW-88P-1	M8	27~50	2.8~5.1	19.9~36.9	70	5,300	12.7	1/2	163	6 27/64	1.40	3.1	0.64	22.5	9.5	3/8

*Marked • are oil bath types. *All Models are double clutch types.
*Air Inlet Thread Size: PT or NPT 1/4".

Straight Models



FW-44SA~66SA

Model	Bolt Size	Recommended Torque Range			Max. Torque	Rotational Frequency	Square Drive Size		Overall Length (without socket)		Mass (without socket)		Air Consumption (at Load)		Air Hose Size	
		mm	N · m	kgf · m			ft · lb	N · m	min ⁻¹	mm	in	mm	in	kg	lb	m ³ /min
•FW-44SA-1	M5	8~16	0.8~1.6	5.9~11.8	20	5,700	9.5	3/8	207	8 5/32	0.66	1.4	0.35	12.4	6.3	1/4
•FW-66SA-1	M6	14~26	1.4~2.7	10.3~19.2	32	5,000	9.5	3/8	212	8 11/32	0.78	1.7	0.37	13.1	6.3	1/4

*Marked • are oil bath types. *All Models are double clutch types.
*Air Inlet Thread Size: PT or NPT 1/4".

Impact Wrenches

IMPACT WRENCHES

Fuji Impact Wrenches are suitable for various fastening and unfastening operations. The combination of high torque and fast run down minimise operator fatigue.

Small Pistol Grip Models

9.5mm(3/8")~15.9mm(5/8")



Model	Bolt Size	Recommended Torque Range			Max. Torque	Rotational Frequency	Square Drive Size		Overall Length (without socket)		Mass (without socket)		Air Consumption (at Load)		Air Hose Size	
		mm	N · m	kgf · m			ft · lb	N · m	min ⁻¹	mm	in	mm	in	kg	lb	m ³ /min
•FW-5PX-6	M5	8~13	0.8~1.3	5.9~9.6	18	12,000	9.5	3/8	150	5 29/32	0.80	1.8	0.20	7.1	6.3	1/4
•FW-6PM-1	M6	14~26	1.4~2.7	10.3~19.2	32	8,500	9.5	3/8	140	5 33/64	0.92	2.0	0.53	18.7	9.5	3/8
•FW-6PL-1	M6	14~26	1.4~2.7	10.3~19.2	32	10,000	9.5	3/8	175	6 57/64	0.90	2.0	0.20	7.1	9.5	3/8
FW-6PX-5	M6	11~23	1.1~2.3	8.1~17.0	30	10,000	9.5	3/8	156	6 9/64	1.20	2.6	0.28	9.9	9.5	3/8
•FW-6PX-6	M6	10~18	1.0~1.8	7.4~13.3	25	10,000	9.5	3/8	156	6 9/64	1.20	2.6	0.28	9.9	9.5	3/8
•FW-6PH-1	M8	27~40	2.8~4.1	19.9~29.5	60	9,000	9.5	3/8	147	5 25/32	1.35	3.0	0.35	12.4	9.5	3/8
•FW-6PH-11	M8	27~40	2.8~4.1	19.9~29.5	60	9,000	12.7	1/2	152	6	1.40	3.1	0.35	12.4	9.5	3/8
•FW-8PH-3	M10	42~80	4.3~8.2	31.0~59.0	130	7,500	12.7	1/2	162	6 3/8	1.50	3.3	0.40	14.1	9.5	3/8
FW-10PX-5	M10	50~100	5.1~10.2	36.9~73.8	150	8,000	12.7	1/2	182	7 11/64	2.30	5.0	0.40	14.1	9.5	3/8
•FW-10PH-1	M10	63~120	6.4~12.2	46.5~88.5	160	7,500	12.7	1/2	179	7 3/64	2.00	4.4	0.45	15.8	9.5	3/8
•FW-10PH-2	M10	47~93	4.8~9.5	34.7~68.6	113	7,500	12.7	1/2	179	7 3/64	2.00	4.4	0.45	15.8	9.5	3/8
FW-14PX-5	M14	100~150	10.2~15.3	73.8~110.6	190	6,500	12.7	1/2	197	7 3/4	3.00	6.6	0.40	14.1	9.5	3/8
•FW-14PH-1	M14	85~140	8.7~14.3	62.7~103.3	180	7,500	12.7	1/2	202	7 15/16	2.56	5.7	0.60	21.2	9.5	3/8
•FW-14PH-2	M14	85~140	8.7~14.3	62.7~103.3	180	7,500	12.7	1/2	202	7 15/16	2.56	5.7	0.60	21.2	9.5	3/8
•FW-14PH-3	M14	85~140	8.7~14.3	62.7~103.3	180	7,500	15.9	5/8	202	7 15/16	2.56	5.7	0.60	21.2	9.5	3/8

*Marked • are double clutch types. Others are single clutch types.

*Air Inlet Thread Size: PT or NPT 1/4".

Straight Models

9.5mm(3/8")~12.7mm(1/2")

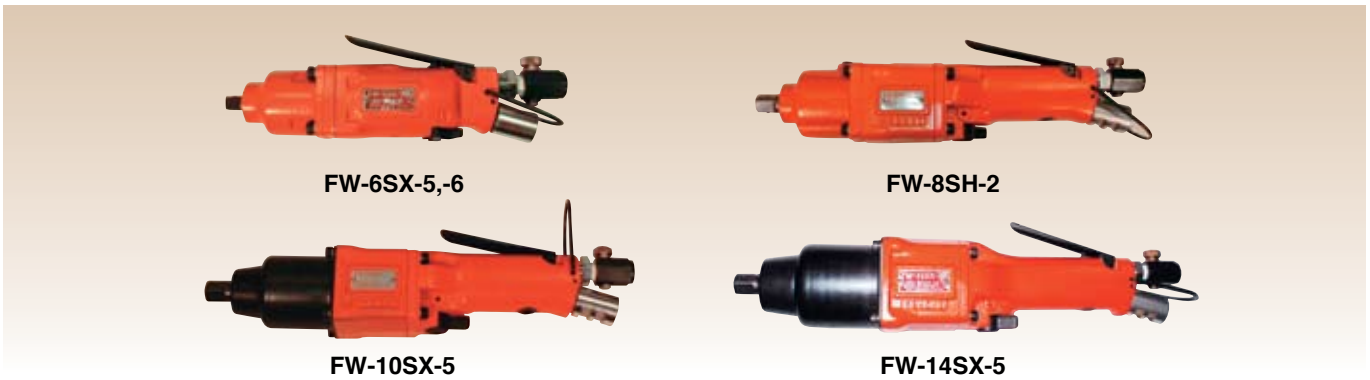

Model	Bolt Size	Recommended Torque Range			Max. Torque	Rotational Frequency	Square Drive Size		Overall Length (without socket)		Mass (without socket)		Air Consumption (at Load)		Air Hose Size	
		mm	N · m	kgf · m			ft · lb	N · m	min ⁻¹	mm	in	mm	in	kg	lb	m ³ /min
FW-6SX-5	M6	11~23	1.1~2.3	8.1~17.0	30	10,000	9.5	3/8	223	8 25/32	1.10	2.4	0.30	10.6	9.5	3/8
•FW-6SX-6	M6	10~18	1.0~1.8	7.4~13.3	25	10,000	9.5	3/8	223	8 25/32	1.10	2.4	0.30	10.6	9.5	3/8
•FW-8SH-2	M10	35~67	3.6~6.8	25.8~49.4	93	8,000	12.7	1/2	306	12 3/64	1.70	3.7	0.40	14.1	9.5	3/8
FW-10SX-5	M10	50~100	5.1~10.2	36.9~73.8	150	8,000	12.7	1/2	317	12 31/64	2.20	4.8	0.40	14.1	9.5	3/8
FW-14SX-5	M14	100~150	10.2~15.3	73.8~110.6	190	6,500	12.7	1/2	356	14 1/64	3.00	6.6	0.50	17.7	9.5	3/8

*Marked • are double clutch types. Others are single clutch types.
*Air Inlet Thread Size: PT or NPT 1/4".

Angle Head Models



Model	Bolt Size	Recommended Torque Range			Max. Torque	Rotational Frequency	Square Drive Size		Overall Length (without socket)		Mass (without socket)		Air Consumption (at Load)		Air Hose Size	
		mm	N · m	kgf · m			ft · lb	N · m	min ⁻¹	mm	in	mm	in	kg	lb	m ³ /min
•FW-6SCX-6	M6	9~18	0.9~1.8	6.6~13.3	20	8,000	9.5	3/8	261	10 9/32	1.60	3.5	0.30	10.5	9.5	3/8
•FW-8SCH-2	M10	33~67	3.4~6.8	24.3~49.4	87	7,500	12.7	1/2	347	13 21/32	2.70	5.9	0.40	14.1	9.5	3/8

*Marked • are double clutch types.
*Air Inlet Thread Size: PT or NPT 1/4".

CORNER ATTACHMENT (ANGLE HEAD)

The Corner Attachment CA-14A can be mounted on straight or pistol grip type impact wrenches FW-14PX, 14SX to access fastening in confined spaces.



CA-14A

IMPACT WRENCHES+CORNER ATTACHMENT



CA-14A + FW-14SX-5

Model	Side to Center		Square Drive Size		Angle Head Height		Overall Length		Mass (without socket)		Models
	mm	in	mm	in	mm	in	mm	in	kg	lb	
CA-14A	24.5	31/32	12.7	1/2	84	3 5/16	146	5 3/4	1.4	3.0	FW-14PX,14SX Series

Impact Wrenches

Medium Size Straight Models

19mm(3/4")~31.8mm(1 1/4")



Model	Bolt Size	Recommended Torque Range			Max. Torque	Rotational Frequency	Square Drive Size		Overall Length (without socket)		Mass (without socket)		Air Consumption (at Load)		Air Inlet Thread Size	Air Hose Size	
		N · m	kgf · m	ft · lb			N · m	min ⁻¹	mm	in	mm	in	kg	lb		m ³ /min	ft ³ /min
FW-19Z-5	M18	235~450	24.0~45.9	173.3~331.9	560	5,000	19.0	3/4	322	12 43/64	5.2	11.5	0.6	21.2	3/8	9.5	3/8
FW-19Z-5C	M18	235~450	24.0~45.9	173.3~331.9	560	5,000	19.0	3/4	322	12 43/64	5.2	11.5	0.6	21.2	3/8	9.5	3/8
FW-250-1	M24	380~1040	38.8~106.1	280.3~767.0	1200	5,000	25.4	1	302	11 57/64	6.0	13.2	0.7	24.7	1/2	12.7	1/2
FW-250-1C	M24	380~1040	38.8~106.1	280.3~767.0	1200	5,000	25.4	1	302	11 57/64	6.0	13.2	0.7	24.7	1/2	12.7	1/2
FW-250-2	M24	380~1040	38.8~106.1	280.3~767.0	1200	5,000	19.0	3/4	302	11 57/64	6.0	13.2	0.7	24.7	1/2	12.7	1/2
FW-250-2C	M24	380~1040	38.8~106.1	280.3~767.0	1200	5,000	19.0	3/4	302	11 57/64	6.0	13.2	0.7	24.7	1/2	12.7	1/2
FW-320-1	M30~M33	600~1800	61.2~183.6	442.5~1327.5	2300	4,800	25.4	1	353	13 29/32	8.7	19.2	1.0	35.3	1/2	12.7	1/2
FW-320-1C	M30~M33	600~1800	61.2~183.6	442.5~1327.5	2300	4,800	25.4	1	353	13 29/32	8.7	19.2	1.0	35.3	1/2	12.7	1/2
•FW-320-1L	M30~M33	600~1800	61.2~183.6	442.5~1327.5	2300	4,800	25.4	1	484	19 1/16	10.0	22.0	1.0	35.3	1/2	12.7	1/2
•FW-320-1CL	M30~M33	600~1800	61.2~183.6	442.5~1327.5	2300	4,800	25.4	1	484	19 1/16	10.0	22.0	1.0	35.3	1/2	12.7	1/2
FW-420-1	M36~M42	900~2500	91.8~255.0	663.8~1843.8	2800	4,500	25.4	1	349	13 3/7	10.8	23.8	1.2	42.4	1/2	19.0	3/4
FW-420-1C	M36~M42	900~2500	91.8~255.0	663.8~1843.8	2800	4,500	25.4	1	349	13 3/7	10.8	23.8	1.2	42.4	1/2	19.0	3/4
•FW-420-1L	M36~M42	900~2500	91.8~255.0	663.8~1843.8	2800	4,500	25.4	1	501	19 3/4	12.5	27.5	1.2	42.4	1/2	19.0	3/4
•FW-420-1CL	M36~M42	900~2500	91.8~255.0	663.8~1843.8	2800	4,500	25.4	1	501	19 3/4	12.5	27.5	1.2	42.4	1/2	19.0	3/4
FW-420-2	M36~M42	900~2500	91.8~255.0	663.8~1843.8	2800	4,500	31.8	1 1/4	351	13 13/16	10.8	23.8	1.2	42.4	1/2	19.0	3/4
FW-420-2C	M36~M42	900~2500	91.8~255.0	663.8~1843.8	2800	4,500	31.8	1 1/4	351	13 13/16	10.8	23.8	1.2	42.4	1/2	19.0	3/4

*Marked • are long anvil types. *Models with C are Inside Lever types.
 •FW-19Z-5 is single clutch types. Other Models are 2-Jaw clutch types.



Medium Size Pistol Grip Models

19mm(3/4")~25.4mm(1")



Model	Bolt Size	Recommended Torque Range			Max. Torque	Rotational Frequency	Square Drive Size		Overall Length (without socket)		Mass (without socket)		Air Consumption (at Load)		Air Inlet Thread Size	Air Hose Size	
		mm	N · m	kgf · m			ft · lb	N · m	min ⁻¹	mm	in	mm	in	kg		lb	m ³ /min
FW-19PX-5	M18	235~450	24.0~45.9	173.3~331.9	560	5,000	19.0	3/4	239	9 13/32	4.4	9.7	0.6	21.2	1/4	9.5	3/8
FW-250P-1	M24	380~1040	38.8~106.1	280.3~767.0	1200	5,000	25.4	1	228	8 31/32	5.3	11.7	0.7	24.7	3/8	12.7	1/2
FW-250P-2	M24	380~1040	38.8~106.1	280.3~767.0	1200	5,000	19.0	3/4	228	8 31/32	5.3	11.7	0.7	24.7	3/8	12.7	1/2
FW-320P-1	M30~M33	600~1800	61.2~183.6	442.5~1327.5	2300	4,800	25.4	1	268	10 36/64	8.0	17.6	1.0	35.3	3/8	12.7	1/2

*FW-19PX-5 is single clutch types. Other Models are 2-Jaw clutch types.

Heavy Duty Straight Models

38.1mm(1 1/2")~63.5mm(2 1/2")

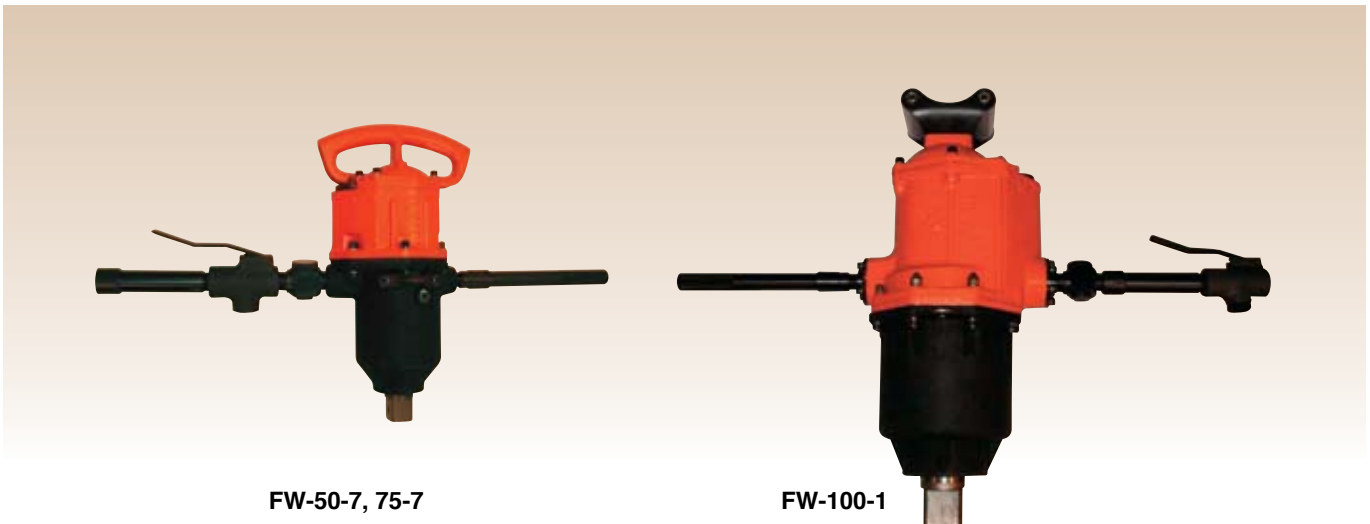

Model	Bolt Size	Recommended Torque Range			Max. Torque	Rotational Frequency	Square Drive Size		Overall Length (without socket)		Mass (without socket)		Air Consumption (at Load)		Air Inlet Thread Size	Air Hose Size	
		mm	N · m	kgf · m			ft · lb	N · m	min ⁻¹	mm	in	mm	in	kg		lb	m ³ /min
FW-50-7	M50	3300~7050	336.6~719.1	2433.8~5199.4	8400	4,000	38.1	1 1/2	500	19 11/16	33.0	72.6	1.9	67.3	1	19.0	3/4
FW-75-7	M68	5100~12400	520.2~1264.8	3761.3~9145.0	14000	3,000	63.5	2 1/2	610	24 1/64	60.0	132.0	2.1	74.9	1	19.0	3/4
FW-100-1	M76	9250~20800	943.5~2121.6	6821.9~15340.0	22000	2,500	63.5	2 1/2	700	27 9/16	85.0	188.7	3.2	114.1	1	25.4	1

*All Models are double clutch types.

Screw Drivers

SCREW DRIVERS

Fuji screw drivers are suitable for a wide range of screw fastening and disassembly applications. The compact and lightweight design provides operator comfort. All models are reversible via a reverse lever or push button. Impact clutch type models are all of "double" clutch design and their high torque and fast run-down minimise operator fatigue. Slip clutch type models are suitable for sheet metal screws and the torque setting can be adjusted easily.

IMPACT CLUTCH TYPE

Straight Models



Model	Bolt Size	Recommended Torque Range			Max. Torque	Rotational Frequency	Bit Shank Size		Overall Length (without socket)		Mass (without socket)		Air Consumption (at Load)		Air Hose Size	
		mm	N · m	kgf · m			ft · lb	N · m	min ⁻¹	mm	in	mm	in	kg	lb	m ³ /min
FW-5SXD-7	M5	6~11	0.6~1.1	4.4~8.1	20	12,000	6.35	1/4	223	8 25/32	0.70	1.5	0.20	7.1	6.3	1/4
FW-5SXD-70	M5	6~11	0.6~1.1	4.4~8.1	20	12,000	6.35	1/4	223	8 25/32	0.70	1.5	0.20	7.1	6.3	1/4
FW-5SXD-8	M5	6~11	0.6~1.1	4.4~8.1	20	12,000	6.35	1/4	193	7 19/32	0.65	1.4	0.20	7.1	6.3	1/4
FW-5SXD-80	M5	6~11	0.6~1.1	4.4~8.1	20	12,000	6.35	1/4	193	7 19/32	0.65	1.4	0.20	7.1	6.3	1/4
FW-6SXD-6	M6	10~18	1.0~1.8	7.4~13.3	25	10,000	6.35	1/4	235	9 1/4	1.10	2.4	0.30	10.6	9.5	3/8
FW-6SXD-60	M6	10~18	1.0~1.8	7.4~13.3	25	10,000	6.35	1/4	235	9 1/4	1.10	2.4	0.30	10.6	9.5	3/8

*Air Inlet Thread Size: PT or NPT 1/4".

Pistol Grip Models

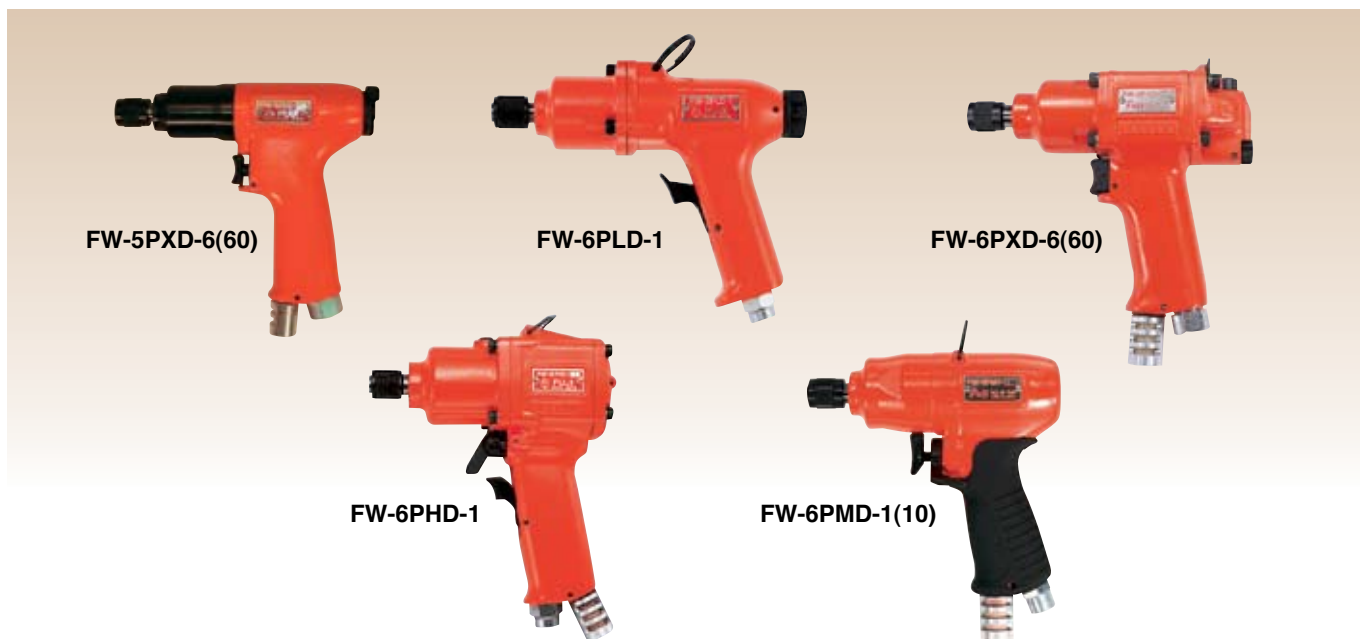

Model	Bolt Size	Recommended Torque Range			Max. Torque	Rotational Frequency	Bit Shank Size		Overall Length (without socket)		Mass (without socket)		Air Consumption (at Load)		Air Hose Size	
		mm	N · m	kgf · m			ft · lb	N · m	min ⁻¹	mm	in	mm	in	kg	lb	m ³ /min
FW-5PXD-6	M5	6~11	0.6~1.1	4.4~8.1	20	12,000	6.35	1/4	160	6 19/64	0.80	1.8	0.30	10.6	6.3	1/4
FW-5PXD-60	M5	6~11	0.6~1.1	4.4~8.1	20	12,000	6.35	1/4	160	6 19/64	0.80	1.8	0.30	10.6	6.3	1/4
FW-6PMD-1	M6	11~22	1.1~2.2	8.1~16.2	34	8,500	6.35	1/4	146	5 3/4	0.92	2.0	0.53	18.7	9.5	3/8
FW-6PMD-10	M6	11~22	1.1~2.2	8.1~16.2	34	8,500	6.35	1/4	146	5 3/4	0.92	2.0	0.53	18.7	9.5	3/8
FW-6PLD-1	M6	11~22	1.1~2.2	8.1~16.2	34	10,000	6.35	1/4	182	7 11/64	0.90	2.0	0.20	7.1	9.5	3/8
FW-6PXD-6	M6	10~18	1.0~1.8	7.4~13.3	25	10,000	6.35	1/4	168	6 5/8	1.20	2.6	0.28	9.9	9.5	3/8
FW-6PXD-60	M6	10~18	1.0~1.8	7.4~13.3	25	10,000	6.35	1/4	168	6 5/8	1.20	2.6	0.28	9.9	9.5	3/8
FW-6PHD-1	M8	19~40	1.9~4.1	14.0~29.5	60	9,000	6.35	1/4	154	6 1/6	1.35	3.0	0.35	12.4	9.5	3/8

*Air Inlet Thread Size: PT or NPT 1/4".

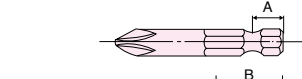
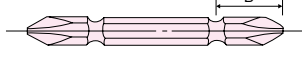
Bit Size		FW-*SXD-6, 7, 8, *PXD-6, *P*D-1 A:9.5mm B:12mm
		FW-*SXD-60, 70, 80, *PXD-60, *P*D-10 A:13mm B:16mm

IMPACT CLUTCH TYPE



FW-44SAD~66SAD



FW-44PAD~66PAD

Model	Bolt Size	Recommended Torque Range			Max. Torque	Rotational Frequency	Bit Shank Size		Overall Length (without socket)		Mass (without socket)		Air Consumption (at Load)		Air Hose Size	
		mm	N · m	kgf · m			ft · lb	N · m	min ⁻¹	mm	in	mm	in	kg	lb	m ³ /min
Straight Models																
•FW-44SAD-1	M5	6~13	0.6~1.3	4.4~9.6	20	5,700	6.35	1/4	207	8 5/32	0.66	1.4	0.35	12.4	6.3	1/4
•FW-44SAD-10	M5	6~13	0.6~1.3	4.4~9.6	20	5,700	6.35	1/4	207	8 5/32	0.66	1.4	0.35	12.4	6.3	1/4
•FW-66SAD-1	M6	11~20	1.1~2.0	8.1~14.8	28	5,000	6.35	1/4	218	8 19/32	0.78	1.7	0.37	13.1	6.3	1/4
•FW-66SAD-10	M6	11~20	1.1~2.0	8.1~14.8	28	5,000	6.35	1/4	218	8 19/32	0.78	1.7	0.37	13.1	6.3	1/4
Pistol Grip Models																
•FW-44PAD-2	M5	6~13	0.6~1.3	4.4~9.6	20	6,500	6.35	1/4	132	5 3/16	0.78	1.7	0.60	21.2	6.3	1/4
•FW-44PAD-20	M5	6~13	0.6~1.3	4.4~9.6	20	6,500	6.35	1/4	132	5 3/16	0.78	1.7	0.60	21.2	6.3	1/4
•FW-66PAD-2	M6	11~20	1.1~2.0	8.1~14.8	28	5,000	6.35	1/4	143	5 5/8	0.88	1.9	0.48	16.9	6.3	1/4
•FW-66PAD-20	M6	11~20	1.1~2.0	8.1~14.8	28	5,000	6.35	1/4	143	5 5/8	0.88	1.9	0.48	16.9	6.3	1/4

*Marked • are oil bath types.
*Air Inlet Thread Size: PT or NPT 1/4".

SLIP CLUTCH TYPE



FD-4
FD-5



FD-4P
FD-5P

Model	Bolt Size	Recommended Torque Range			Rotational Frequency	Bit Shank Size		Overall Length (without socket)		Mass (without socket)		Air Consumption (at Load)	
		mm	N · m	kgf · m		ft · lb	mm	in	mm	in	kg	lb	m ³ /min
Straight Models													
FD-4	M4	1~4	0.1~0.4	0.7~3.0	2,000	6.35	1/4	174	6 27/32	0.6	1.3	0.20	7.1
FD-5	M5	6~12	0.6~1.2	4.4~8.9	1,600	6.35	1/4	233	9 11/64	1.0	2.2	0.30	10.6
Pistol Grip Models													
FD-4P	M4	1~4	0.1~0.4	0.7~3.0	2,000	6.35	1/4	173	6 13/16	0.8	1.7	0.20	7.1
FD-5P	M5	6~12	0.6~1.2	4.4~8.9	1,600	6.35	1/4	216	8 1/2	1.2	2.6	0.30	10.6

*Air Inlet Thread Size: PT or NPT 1/4".
*Air Hose Size: 6.3mm(1/4").

Bit Size		FW-SD-1, **SAD-1, FD-4, 4P, 5, 5P FW-SD-2, **PAD-2 A:9.5mm B:12mm
		FW-SD-10, **SAD-10 FW-SD-20, **PAD-20 A:13mm B:16mm

Open-end Wrenches/Ratchet Wrench

OPEN-END WRENCHES

Fuji offers stall torque type Open-end Wrenches for fast, accurate tube nut tightening mainly used in the assembly of hydraulic and pneumatic brake pipes and other hose and cable connections in the car and aircraft assembly lines. Gear driven mechanism without ratcheting provides precise torque, low noise operation and long service life. One hand two-step mechanism simplifies the socket release back to the open position.



FOW-10-1



FOW-10-2

HEAD SIZE

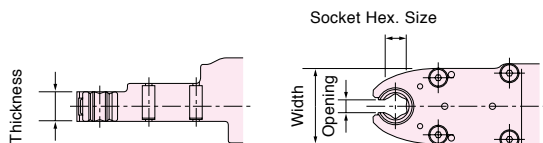

SOCKET SIZE

Model	Socket Hexagon Size (mm)	
	Standard	Other Sizes
FOW-10-1	10	8 • 9 • 3/8"
FOW-10-2	14	10 • 11 • 12 • 13 • 1/2"

*Specify the socket size in ordering the tool.

Model	Max. Torque			Rotational Frequency	Head Size						Hex. Socket Size (Standard)		Overall Length		Mass		Air Consumption (at Load)	
	N • m	kgf • m	ft • lb		Thickness		Opening		Width		mm	in	mm	in	kg	lb	m³/min	ft³/min
FOW-10-1	13.6	1.4	10.0	410	14	35/64	6	15/64	36	1 27/64	10	25/64	294	11 37/64	1.5	3.3	0.4	14.1
FOW-10-2	18.5	1.9	13.6	300	14	35/64	9	23/64	40	1 37/64	14	35/64	306	12 3/64	1.6	3.5	0.4	14.1

*Air Inlet Thread Size: PT or NPT 1/4". *Air Hose Size: 9.5mm (3/8").

RATCHET WRENCHES

Ratchet Wrenches are used for fastening operations in confined spaces where angle impact tools and nutrunners cannot reach. Reverse operation can be accomplished by simply turning the wrench over.



FRW-6NX-3, -4(A)



FRW-8NX-2, (-2A)



FRW-10N-2



FRW-13N-3,4

HEAD SIZE

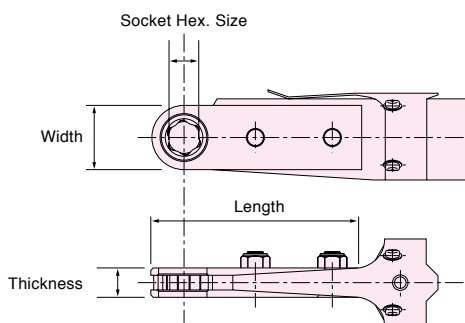

SOCKET SIZE

Model	Socket Hexagon Size (mm)	
	Standard	Other Sizes
FRW-6NX-3	10	8 • 8W • 10W
FRW-6NX-3A	10	8
FRW-6NX-4	13	12 • 12W • 13W
FRW-6NX-4A	13	12
FRW-8NX-2	14	10 • 12 • 13 • 1/2" • 9/16" • 10W • 12W • 13W • 14W
FRW-8NX-2A	14	10 • 12 • 13
FRW-10N-2	17	13 • 14 • 16 • 9/16" • 5/8" • 14W • 17W
FRW-13N-3	21	18 • 19 • 19W • 21W
FRW-13N-4	24	22 • 26 • 27 • 22W • 24W • 26W • 27W

*Specify the socket size in ordering the tool.

Model	Bolt Size	Max. Torque			Rotational Frequency	Hex. Socket Size	Head Size						Overall Length		Mass		Air Consumption (at Load)	
		mm	N • m	kgf • m			ft • lb	min⁻¹	Thickness		Width		Length		mm	in	kg	lb
FRW-6NX-3	M6	10.8	1.1	8.1	200	10	13	33/64	20	25/32	88	3 15/32	316	12 7/16	1.2	2.6	0.25	8.8
FRW-6NX-3A	M6	10.8	1.1	8.1	200	10	10	25/64	20	25/32	88	3 15/32	316	12 7/16	1.2	2.6	0.25	8.8
FRW-6NX-4	M6	12.7	1.3	9.4	170	13	13	33/64	24	61/64	93	3 21/32	320	12 9/16	1.2	2.6	0.25	8.8
FRW-6NX-4A	M6	12.7	1.3	9.4	170	13	10	25/64	24	61/64	93	3 21/32	320	12 9/16	1.2	2.6	0.25	8.8
FRW-8NX-2	M8	29.4	3.0	22.1	200	14	18	45/64	25	63/64	108	4 1/4	378	14 57/64	2.2	4.9	0.43	15.2
FRW-8NX-2A	M8	29.4	3.0	22.1	200	14	10	25/64	25	63/64	108	4 1/4	378	14 57/64	2.1	4.6	0.43	15.2
FRW-10N-2	M10	44.1	4.5	33.1	140	17	18	45/64	33	1 19/64	115	4 17/32	417	16 13/32	2.7	6.0	0.58	20.5
FRW-13N-3	M12	58.8	6.0	44.1	130	21	18	45/64	36	1 27/64	116	4 9/16	419	16 1/2	2.7	6.0	0.58	20.5
FRW-13N-4	M12	78.4	8.0	58.8	100	24	18	45/64	46	1 13/64	129	4 5/64	431	16 31/32	3.0	6.6	0.58	20.5

*Air Inlet Thread Size: PT or NPT 1/4". *Air Hose Size: 9.5mm (3/8").

HEXAGONAL SOCKETS

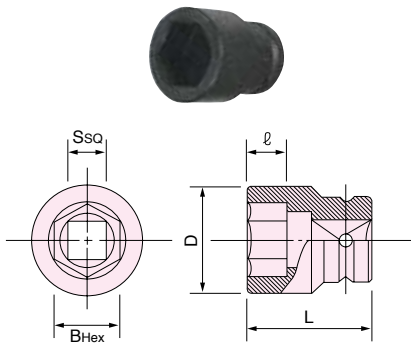

AC No.	Bolt Size		Size					Models
			S (SQ)	B (Hex)	L	l	D	
			mm(in)	mm	mm	mm	mm	
1101	4	-	9.53 (3/8)	7	20	4	13	FET-33~77
1102	5	-		8	25	5	13	FET-777
1103	6	1/4		10	25	7	16	FPT-110~770
1104	7	-		11	25	7	18	FPW-110~770
1133	8	-		12	25	8	19	FW-5
1105	8	-		13	27	8	20	FW-6, 44~66
1106	-	5/16	14	27	8	22		
2101	6	1/4	12.7 (1/2)	10	35	7	18	FET-88~133
2118	8	-		12	35	8	21	FET-888~1333
2102	8	-		13	35	8	21	FPT-880~1330
2103	-	5/16		14	38	9	23	FPW-880~1330
2104	10	3/8		17	38	10	27	FW-6PH-11
2105	12	7/16		19	40	12	30	FW-8
2106	-	1/2		21	40	14	33	FW-88, 10, 14
2107	14	-		22	43	14	34	except for FW-14PH-3
4102	-	1/2		21	50	13	33	
4103	14	-		22	50	14	35	FPT-1660
4104	16	-	24	53	14	38	FPW-1660, 2220	
4105	-	5/8	26	53	15	40	FW-19	
4106	18	-	27	53	15	42	FW-250-2, 2C	
4107	20	-	30	55	16	46	FW-250P-2	
4108	22	3/4	32	55	18	49		
5104	-	7/8	19.0 (3/4)	35	62	19	55	
5105	24	-		36	62	19	56	
5106	27	1		41	68	26	63	
5107	30	1-1/8		46	72	26	69	FW-250-1, 1C
5108	33	1-1/4		50	75	28	73	FW-250P-1
5109	-	1-3/8		54	80	28	78	FW-320
5110	36	-		55	80	28	80	FW-420
5111	-	1-1/2		58	80	31	83	
5112	39	-		60	80	32	86	
6105	36	-		55	82	27	83	
6106	-	1-1/2	58	85	28	87	FW-420-2, 2C	
6107	39	-	60	88	30	89		
7107	-	1-5/8	31.8 (1 1/4)	63	100	30	96	
7108	42	-		65	100	32	98	
7109	-	1-3/4		67	100	33	101	
7110	45	-		70	100	34	104	FW-50-7
7112	48	-		75	105	36	109	
7113	-	2		77	105	38	112	
8110	-	2		77	128	38	122	
8112	56	2-1/4		85	132	43	130	
8114	64	2-1/2		95	140	49	145	
8115	68	-		100	152	52	150	FW-75-7
8116	72	-	105	154	54	168	FW-100-1	
8117	-	3	110	160	60	168		
8120	90	3-1/2	130	170	70	192		
8122	100	4	145	180	79	213		

*Other socket sizes are available at your request.

EXTENSION BARS

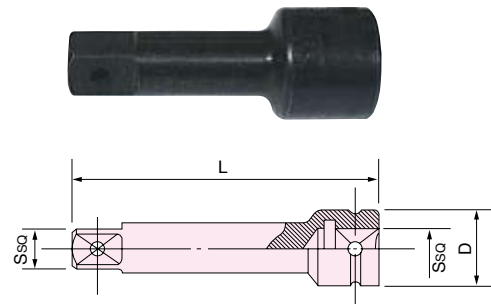

AC No.	Size			Models
	S (SQ)	L	D	
	mm(in)	mm	mm	
1201	9.53 (3/8)	50	19	FET-33~77, 777
1202		75		FPT-110~770
1203		100		FPW-110~770
1204		150		FW-5, 6, 44~66
2201	12.7 (1/2)	50	25	FET-88~133, 888~1333
2202		75		FPT-880~1330, FPW-880~1330
2203		100		FW-6PH-11, 8, 88
2204	150	FW-10, 14 except for FW-14PH-3		
4201	19.0 (3/4)	75	37	FPT-1660, FPW-1660, 2220
4202		100		FW-19
4203		150		FW-250-2, 2C
4204		200		FW-250P-2
5201	25.4 (1)	100	49	FW-250-1, 1C
5202		160		FW-250P-1
5203		200		FW-320
5204	300	FW-420		
6201	31.8 (1 1/4)	150	62	
6202		200		
6203		250		FW-420-2, 2C
6204		300		
7204	38.1 (1 1/2)	200	69	
7201		300		FW-50-7
8201	63.5 (2 1/2)	300	130	FW-75-7
8202		457		FW-100-1

UNIVERSAL JOINTS

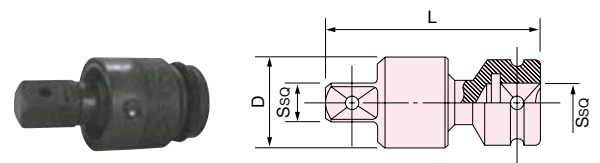

AC No.	Size			Models
	S (SQ)	L	D	
	mm(in)	mm	mm	
1501	9.53(3/8)	48	24	FET-33~77, 777
				FPT-110~770
				FPW-110~770
				FW-5, 6, 44~66
2502	12.7(1/2)	68	32	FET-88~133, 888~1333
				FPT-880~1330, FPW-880~1330
				FW-6PH-11, 8, 88
				FW-10, 14 except for FW-14PH-3
4502	19.0(3/4)	112	52	FPT-1660, FPW-1660, 2220
				FW-19
				FW-250-2, 2C
5502	25.4(1)	128	61	FW-250~420
6502	31.8(1 1/4)	151	74	FW-420-2, 2C
7503	38.1(1 1/2)	202	102	FW-50-7

BITS SELECTION GUIDE

Fuji offers two types of screwdriver bits according to their neck length. Select suitable models or bits using the following table. Our screwdriver bits are available in three different categories of hardness to cover almost all applications: H(hard), G(standard), E(soft). The most common hardness bit are listed. Other hardness's are available on request.

GROUP	MODELS
(1)	FET-33D-10, 44D-30, 55D-30, 66D-30, FPT-110D-10, 330D-10, 440D-10, 550D-10, 660D-10, 110SD-10, 330SD-10, 440SD-10, 550SD-10, 660SD-10 FPW-110D-10, 330D-10, 440D-30, 550D-30, 660D-40, 770D-30, 110SD-10, 330SD-10, 440SD-10, 550SD-10, 660SD-10 FW-5SXD-70, 80, 6SXD-60, 5PXD-60, 6PMD-10, 6PLD-10, 6PXD-60, 6PHD-10, 44SAD-10, 66SAD-10, 44PAD-20, 66PAD-20
(2)	FET-33D-1, 44D-3, 55D-3, 66D-3, FPT-110D-1, 330D-1, 440D-1, 550D-1, 660D-1, 110SD-1, 330SD-1, 440SD-1, 550SD-1, 660SD-1 FPW-110D-1, 330D-1, 440D-3, 550D-3, 660D-4, 770D-3, 110SD-1, 330SD-1, 440SD-1, 550SD-1, 660SD-1 FW-5SXD-7, 8, 6SXD-6, 5PXD-6, 6PMD-1, 6PLD-1, 6PXD-6, 6PHD-1, 44SAD-1, 66SAD-1, 44PAD-2, 66PAD-2, FD-4, 5, 4P, 5P

SLOTTED BITS

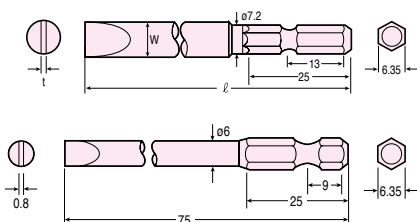

Thickness mm	Width mm	Length mm	Hardness	AC No.	Model Group
0.8	6	45	G	A166045	(1)
0.8	6	70	G	A166070	(1)
1.0	8	45	G	A168045	(1)
1.0	8	70	G	A168070	(1)
1.2	10	52	G	A161052	(1)
1.2	10	70	G	A161070	(1)
0.8	6	75	E	B356075	(2)

*Minimum order required : 100pcs./item.

CROSS RECESSED BITS SINGLE-ENDED

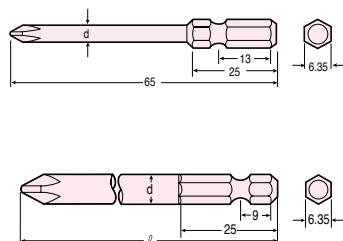

Diameter mm	Point Size	Length mm	Hardness	AC No.	Model Group
3	1	65	H	A161065	(1)
4.5	2	65	H	A162065	(1)
7	1	50	H	B351050	(2)
7	1	75	H	B351075	(2)
4.5	1	100	H	B351100	(2)
7	2	50	G	B352050	(2)
7	2	75	G	B352075	(2)
7	2	100	G	B352100	(2)
7	2	150	G	B352150	(2)
4.5	2	100	H	B252100	(2)
7	3	75	E	B353075	(2)
7	3	100	E	B353100	(2)
7	3	150	G	B353150	(2)

*Minimum order required : 100pcs./item.

CROSS RECESSED BITS DOUBLE-ENDED

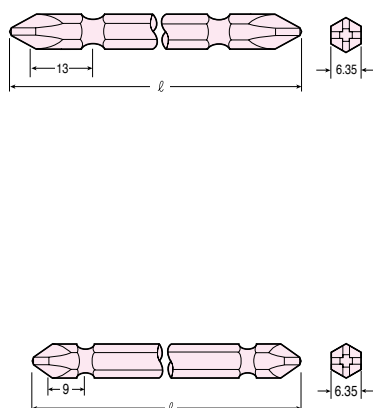

Point Size	Length mm	Hardness	AC No.	Model Group
1	45	H	A141045	(1)
1	65	H	A141065	(1)
1	110	H	A141110	(1)
2	45	G	A142045	(1)
2	65	G	A142065	(1)
2	110	G	A142110	(1)
2	150	G	A142150	(1)
2	200	G	A142200	(1)
2	300	G	A142300	(1)
3	45	E	A143045	(1)
3	65	E	A143065	(1)
3	110	E	A143110	(1)
1	75	H	B431075	(2)
2	50	H	B432050	(2)
2	75	G	B432075	(2)
2	100	G	B432100	(2)
2	150	G	B432150	(2)
2	200	G	B432200	(2)
3	75	E	B433075	(2)
3	100	E	B433100	(2)

*Minimum order required : 100pcs./item.

CROSS RECESSED BITS DOUBLE-ENDED TORSION TYPE

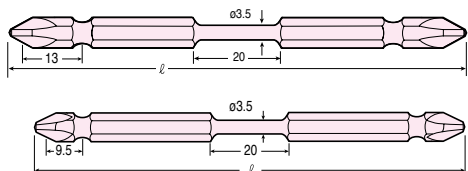

Diameter mm	Point Size	Length mm	Hardness	AC No.	Model Group
3.5	2	65	H	AT142065	(1)
3.5	2	110	H	AT142110	(1)
3.5	2	75	H	BT432075	(2)
3.5	2	100	H	BT432100	(2)

*Minimum order required : 100pcs./item.

ALLEN BITS

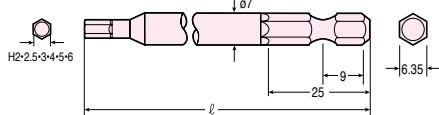
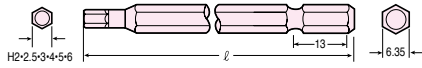

Hex Size	Length	Hardness	AC No.	Model Group
mm	mm			
2	65	H	A16H2065	(1)
2	110	H	A16H2110	(1)
2.5	65	H	A16H25065	(1)
2.5	110	H	A16H25110	(1)
3	65	H	A16H3065	(1)
3	110	H	A16H3110	(1)
4	65	H	A16H4065	(1)
4	110	H	A16H4110	(1)
5	65	G	A16H5065	(1)
5	110	G	A16H5110	(1)
6	65	G	A16H6065	(1)
6	110	G	A16H6110	(1)
2	75	H	B35H2075	(2)
2	100	H	B35H2100	(2)
2.5	75	H	B35H25075	(2)
2.5	100	H	B35H25100	(2)
3	75	H	B35H3075	(2)
3	100	H	B35H3100	(2)
4	75	H	B35H4075	(2)
4	100	H	B35H4100	(2)
5	75	G	B35H5075	(2)
5	100	G	B35H5100	(2)
6	75	G	B35H6075	(2)
6	100	G	B35H6100	(2)

*Minimum order required : 100pcs./item.

TORX® BITS

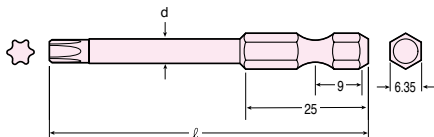
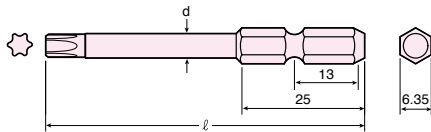

Point Size	Length	Body Diameter	AC No.	Model Group
	mm	mm		
T6	65	4.0	VT6065	(1)
T8	65	4.5	VT8065	(1)
T8	110	4.5	VT8110	(1)
T10	65	4.5	VT10065	(1)
T10	110	4.5	VT10110	(1)
T15	65	4.5	VT15065	(1)
T15	110	4.5	VT15110	(1)
T20	65	5.0	VT20065	(1)
T20	110	5.0	VT20110	(1)
T25	65	5.0	VT25065	(1)
T25	110	5.0	VT25110	(1)
T27	65	5.5	VT27065	(1)
T27	110	5.5	VT27110	(1)
T30	65	6.0	VT30065	(1)
T30	110	6.0	VT30110	(1)
T40	65	H6.35	VT40065	(1)
T40	110	H6.35	VT40110	(1)
T6	75	4.0	JT6075	(2)
T6	100	4.0	JT6100	(2)
T8	75	4.5	JT8075	(2)
T8	100	4.5	JT8100	(2)
T10	75	4.5	JT10075	(2)
T10	100	4.5	JT10100	(2)
T15	75	4.5	JT15075	(2)
T15	100	4.5	JT15100	(2)
T20	75	5.0	JT20075	(2)
T20	100	5.0	JT20100	(2)
T25	75	5.0	JT25075	(2)
T25	100	5.0	JT25100	(2)
T27	75	5.5	JT27075	(2)
T27	100	5.5	JT27100	(2)
T30	75	6.0	JT30075	(2)
T30	100	6.0	JT30100	(2)
T40	75	7.0	JT40075	(2)
T40	100	7.0	JT40100	(2)
T45	75	8.0	JT45075	(2)
T45	100	8.0	JT45100	(2)

*Minimum order required : 100pcs./item.

Accessories

SOCKET HEAD BITS

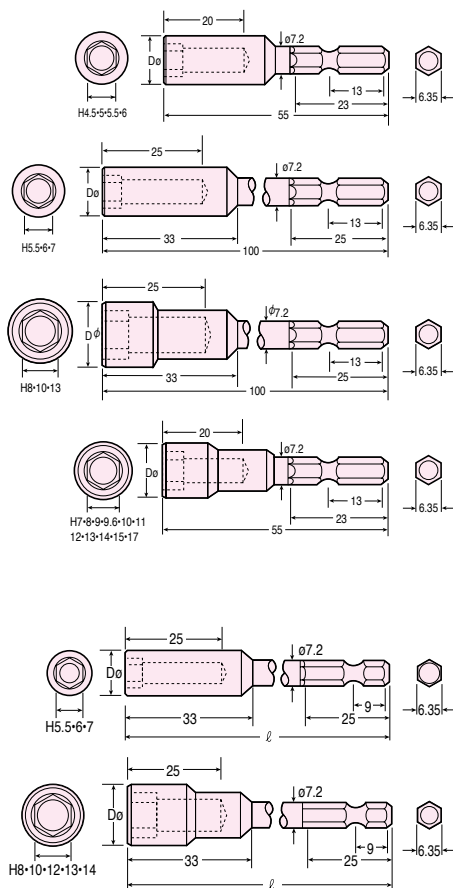

Hex Size mm	Length mm	Body Diameter mm	AC No.	Model Group
4.5	55	7.5	A2045055	(1)
5	55	8.5	A205055	(1)
5.5	55	10	A2055055	(1)
5.5	100	10	A2055100	(1)
6	55	10	A206055	(1)
6	100	10	A206100	(1)
7	55	13	A207055	(1)
7	100	13	A207100	(1)
8	55	13	A208055	(1)
8	100	13	A208100	(1)
9	55	16	A209055	(1)
10	55	16	A2010055	(1)
10	100	16	A2010100	(1)
11	55	16	A2011055	(1)
12	55	19	A2012055	(1)
12	100	19	A2012100	(1)
13	55	19	A2013055	(1)
13	100	19	A2013100	(1)
14	55	20	A2014055	(1)
15	55	22	A2015055	(1)
17	55	23	A2017055	(1)
5.5	75	10	B4555075	(2)
5.5	100	10	B4555100	(2)
6	100	10	B456100	(2)
7	75	13	B457075	(2)
7	100	13	B457100	(2)
8	75	13	B458075	(2)
8	100	13	B458100	(2)
8	150	13	B458150	(2)
10	75	16	B4510075	(2)
10	100	16	B4510100	(2)
10	150	16	B4510150	(2)
12	100	18	B4512100	(2)
13	75	19	B4513075	(2)
13	100	19	B4513100	(2)
14	100	20	B4514100	(2)

*Minimum order required : 100pcs./item.

ALLEN SOCKETS

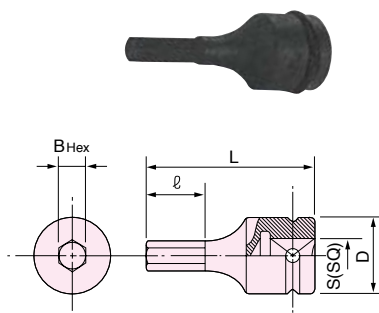

AC No.	Size					Models
	S (SQ) mm(in)	B (Hex) mm	L mm	ℓ mm	D mm	
HG-3-4	9.53 (3/8)	4	50	15	19	FET-33~77, 777
HG-3-5		5	50	17	19	FPT-110~770
HG-3-6		6	50	18	19	FPW-110~770
HG-3-8		8	60	23	20	FW-5,
HG-3-10		10	60	27	20	FW-6, 44~66
HG-4-6	12.7 (1/2)	6	60	18	25	FET-88-133, 888-1333
HG-4-8		8	60	23	25	FPT-880-1330
HG-4-10		10	68	27	27	FPW-880-1330
HG-4-12		12	68	30	27	FW-6PH-11, 8, 88
HG-4-14		14	78	40	28	FW-10, 14 except for FW-14PH-3

CHUCKS FOR WRENCHES FOR USE OF BITS

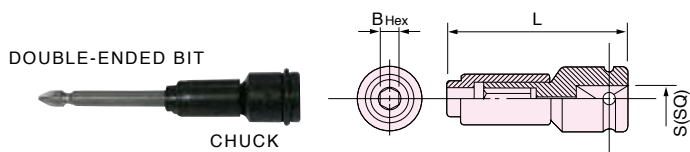

AC No.	Size			Models
	S (SQ) mm(in)	B (Hex) mm	L mm	
DC-1	9.53(3/8)	6.35(1/4)	51	FET-33~77, 777, FPT-110~770 FPW-110~770, FW-5, 6, 44~66
DC-2	12.7(1/4)	8.00(5/16)	56	FET-88-133, 888-1333, FPT-880-1330, FPW-880-1330 FW-6PH-11, 8, 88, 10, 14 except for FW-14PH-3

TOOL COVER FOR FPW SERIES

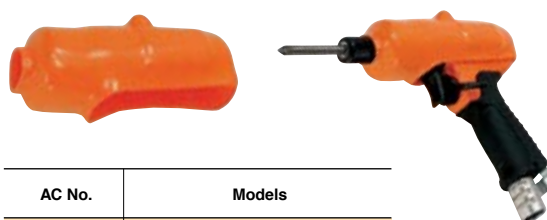

AC No.	Models
TCV-1	FPW-440~550
TCV-2	FPW-660

Abrasive Tools

[Abrasive Tools]

INSTRUCTION AND WARNING

FOR SAFETY USE GRINDERS AND SANDERS	42
FEATURES	43
PENCIL GRINDER / TURBO GRINDERS.....	44
DIE GRINDERS	45
LOW SPEED GRINDERS	49
STRAIGHT GRINDERS	50
EXTENDED GRINDERS	51
ANGLE GRINDERS	52
ANGLE SANDERS	56
ANGLE CUTTERS / DISC SANDER	57
VERTICAL GRINDERS	58
BELT SANDERS	59
ORBITAL SANDERS	60

[Accessories-Abrasive Tools]	62
------------------------------------	----



INSTRUCTION AND WARNING FOR SAFETY USE GRINDERS AND SANDERS

1) INTENDED USE

The tool is designed to be used with abrasive product for grinding, cutting and sanding materials. Do not use the tool for any other purpose.

2) PROTECTIVE EQUIPMENT

Always wear necessary protective equipment such as an eye protector, an ear protector, a face shield, a safety apron, a helmet, gloves and other necessary protective clothing. Use protective barriers where necessary.



3) MAXIMUM SPEEDS OF ABRASIVE PRODUCT AND TOOL

Always check the spindle speed of the tool when mounting the abrasive product. Ensure that the maximum free speed rating of the abrasive product is above that of the tool in use.

4) WHEEL SIZES OF ABRASIVE PRODUCT AND PERIPHERAL SPEED

The following is a reference of Grinding wheel size / Peripheral speed / Maximum free speed. When using abrasive product, on which the peripheral speed is shown instead of the maximum allowable free speed, refer to the reference.

Wheel diameter / Peripheral speed / Maximum free speed

Grinding wheel diameter	Peripheral speed (m/s)														
	10	15	20	25	28	30	33	35	40	45	48	50	60	70	80
mm	Maximum free speed (min ⁻¹)														
25	7639	11459	15279	19099	21390	22918	25210	26738	30558	34377	36669	38197	45837	53476	61115
40	4775	7162	9549	11937	13369	14324	15756	16711	19099	21486	22918	23873	28648	33423	38197
50	3820	5730	7639	9549	10695	11459	12605	13369	15279	17189	18335	19099	22918	26738	30558
63	3032	4547	6063	7579	8488	9095	10004	10610	12126	13642	14551	15158	18189	21221	24252
80	2387	3581	4775	5968	6685	7162	7878	8356	9549	10743	11459	11937	14324	16711	19099
100	1910	2865	3820	4775	5348	5730	6303	6685	7639	8594	9167	9549	11459	13369	15279
115	1661	2491	3321	4152	4650	4982	5480	5813	6643	7473	7972	8304	9964	11625	13286
125	1528	2292	3056	3820	4278	4584	5042	5348	6112	6875	7334	7639	9167	10695	12223
150	1273	1910	2546	3183	3565	3820	4202	4456	5093	5730	6112	6366	7639	8913	10186
180	1061	1592	2122	2653	2971	3183	3501	3714	4244	4775	5093	5305	6366	7427	8488
200	955	1432	1910	2387	2674	2865	3151	3342	3820	4297	4584	4775	5730	6685	7639
230	830	1246	1661	2076	2325	2491	2740	2906	3321	3737	3986	4152	4982	5813	6643
250	764	1146	1528	1910	2139	2292	2521	2674	3056	3438	3667	3820	4584	5348	6112
300	637	955	1273	1592	1783	1910	2101	2228	2546	2865	3056	3183	3820	4456	5093

5) CORRECT WHEEL GUARD AND FLANGES FOR GRINDER

Always use the wheel guard and wheel flanges supplied with the tool and ensure that they are mounted correctly with the appropriate tightness when mounting the abrasive product. Only trained & qualified personnel should mount the abrasive product. Do not use a wheel guard or the flanges if they are damaged or worn. Do not modify or repair a wheel guard or flanges.

6) CORRECT ABRASIVE PRODUCT TO CORRECT TOOL

Make sure the dimensions of the abrasive product are compatible with the tool and that the abrasive product fits the spindle of the tool.

7) MOUNTING AND DISMOUNTING ABRASIVE PRODUCT

When mounting and dismounting the abrasive product, make sure to disconnect tool. Make sure the dimensions of the abrasive product are compatible with the tool and that the abrasive product fits the spindle of the tool.

8) TOOL WITH SPEED GOVERNOR

For the grinder with a speed governor, check the maximum free speed regularly. Make it a rule to check the maximum free speed, whenever before use.

FEATURES

1 REAR EXHAUST

The rear exhaust reduces the risk of scattering debris such as grindings, shavings, etc. due to the exhaust air direction. In addition, when using the inlet and exhaust hoses supplied with the tools, this helps to reduce the sound level.

FG-06-1, 13X, 12UX, 25DX, 26X, 50X, FA-2CX, 3CX SERIES



2 CENTRIFUGAL SPEED GOVERNOR

The speed governor maintains the working speed of the tool to a better degree than a conventional tool without a governor. Consequently, the abrasive life is improved due to the stability of the cutting speed. It is less susceptible to changes in air pressure and wear of the governor parts.

ANGLE, STRAIGHT, VERTICAL GRINDERS

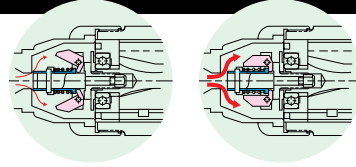

3 ANTI-FREEZING SWIVEL SILENCER

The anti-freezing swivel silencer minimises the effect of freezing during operation of the tool. In addition, it also enables the operator to direct the exhaust air to provide maximum operator comfort.

ANGLE GRINDERS EXCEPT FA-2C, 3CX, 150K SERIES



4 GEAR COOLING DEVICE

The patented gear cooling device helps to minimise wearing of the bevel gear and pinion by metering some exhaust air through them and providing a cooling effect.

ANGLE GRINDERS



5 LOCKING LEVER HANDLE

The locking lever helps to reduce the risk of inadvertent starting of the tool. The operator needs to push the locking lever, or the locking button, to start operation of the tool. When the lever is released, the tool automatically reverts to the locked condition.

MODELS WITH "F" OR "M" AT THE END OF THE MODEL NAMES

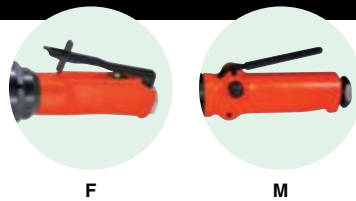

6 ACCURATE COLLET ALIGNMENT

The collet is mounted in the spindle in order to provide minimal deflection.

Furthermore, the compact collet nut enables finishing operations in confined spaces.

DIE GRINDERS



7 STURDY STEEL HOUSING

Die Grinders feature a compact and durable steel housing for longer service life.

FG-13-2, 20, 13X-2, 20, 26-20, 26X-20, 50-2, 50X-2, 26L, 50L, 50Y



Pencil Grinder/Turbo Grinders

PENCIL GRINDER

Pencil Grinders are excellent tools for deburring, contouring and light grinding when used with a rotary burr. The small compact diameter, and light weight, aid precise application.

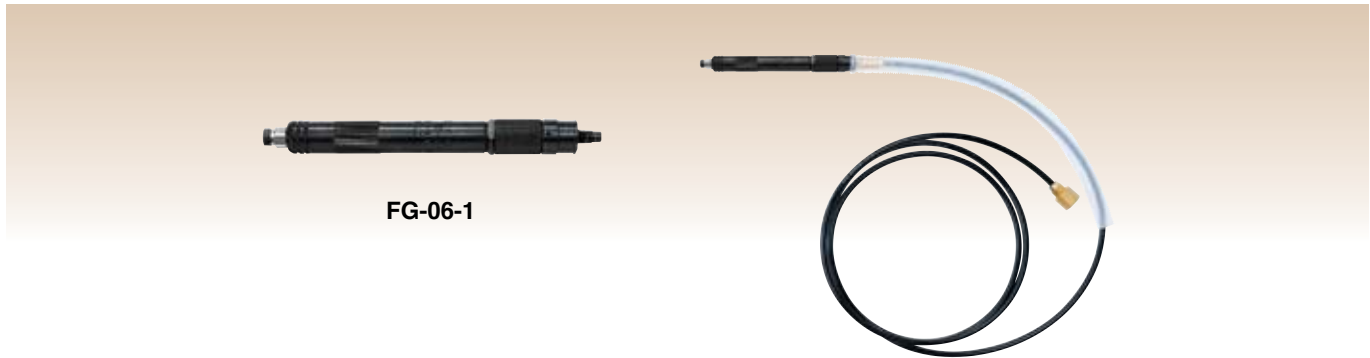

FG-06-1

Model	Collet Size		Max. Dia.				Rotational Frequency	Overall Length		Mass		Max. Air Consumption		Air Hose Size	
			Mounted Wheel		Burr Head										
	mm	in	mm	in	mm	in		min ⁻¹	mm	in	kg	lb	m ³ /min	ft ³ /min	mm
FG-06-1	3	1/8	10	3/8	6	1/4	60,000	153	6 1/32	0.2	0.4	0.17	6.0	4.0	5/32

*Air Inlet Thread Size: PT or NPT 1/4".

TURBO GRINDERS

Super high speed operation provides a more precise finish. Ø3mm or Ø1/8" and Ø6mm or Ø1/4" collet sizes are available to suit the application.

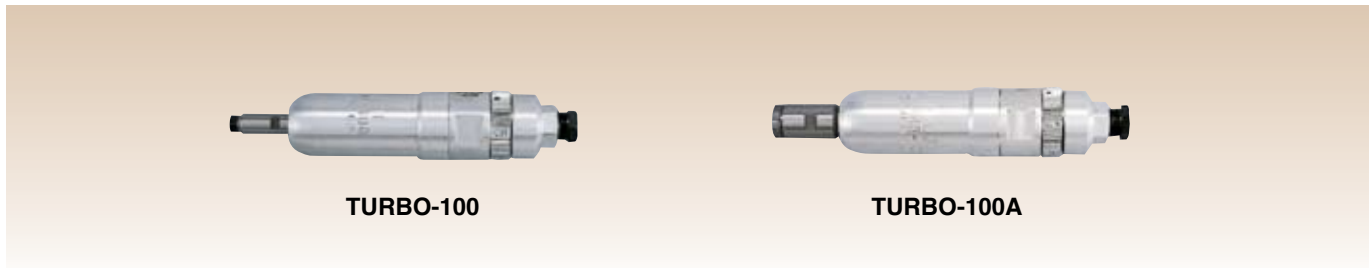

TURBO-100

TURBO-100A

Model	Collet Size		Max. Dia.				Rotational Frequency	Overall Length		Mass		Max. Air Consumption		Air Hose Size	
			Mounted Wheel		Burr Head										
	mm	in	mm	in	mm	in		min ⁻¹	mm	in	kg	lb	m ³ /min	ft ³ /min	mm
TURBO-100	3	1/8	8	5/16	6	1/4	80,000~100,000	153	6 1/32	0.2	0.4	0.28	9.8	4.0	5/32
TURBO-100A	6	1/4	8	5/16	8	5/16	80,000~100,000	155	6 7/64	0.2	0.4	0.28	9.8	4.0	5/32

*Air Inlet Thread Size: PT or NPT 1/8".

Accessories Provided for Turbo Series



- F-101 Open-End Wrench 1
- F-301 Hex. Wrench 1
- IH-4B Inlet Hose 1
- AL3000-1/4 Oiler 1
- F-501 Pin Wrench 1
- BB-SF0011 Ball Bearing..... 2

DIE GRINDERS

Fuji Die Grinders feature accurate collet alignment, light weight, compact design and high power-to-weight ratio. They are widely used for grinding and deburring with either a mounted wheel or rotary burr. Model variations include locking lever, roll handle front or side exhaust, rear exhaust and extended spindle.

Roll Handle Models

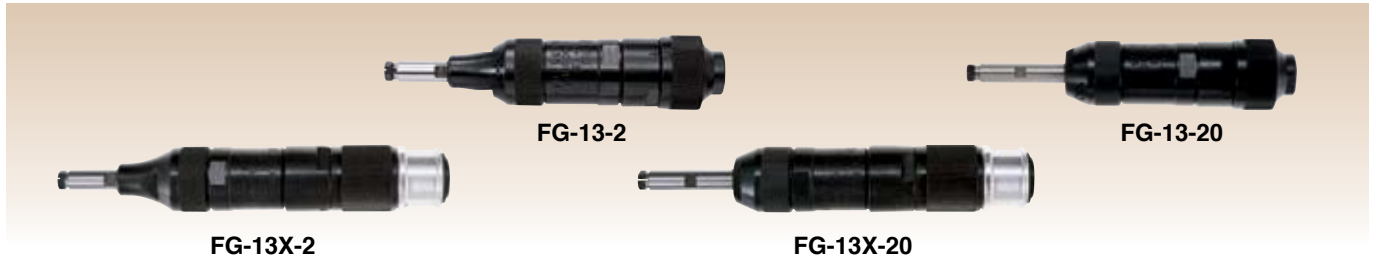

Model	Collet Size		Max. Dia.				Rotational Frequency	Overall Length		Mass		Max. Air Consumption		Air Hose Size	
	mm	in	Mounted Wheel		Burr Head			mm	in	kg	lb	m ³ /min	ft ³ /min	mm	in
Front Exhaust Type															
FG-13-2	3	1/8	13	1/2	10	3/8	30,000	150	5 29/32	0.5	1.1	0.25	8.8	6.3	1/4
FG-13-20	3	1/8	13	1/2	10	3/8	30,000	150	5 29/32	0.5	1.1	0.25	8.8	6.3	1/4
Rear Exhaust Type															
FG-13X-2	3	1/8	13	1/2	10	3/8	30,000	179	7 3/64	0.5	1.1	0.21	7.4	6.3	1/4
FG-13X-20	3	1/8	13	1/2	10	3/8	30,000	179	7 3/64	0.5	1.1	0.21	7.4	6.3	1/4

*Air Inlet Thread Size: PT or NPT 1/4".

Lever Handle Models

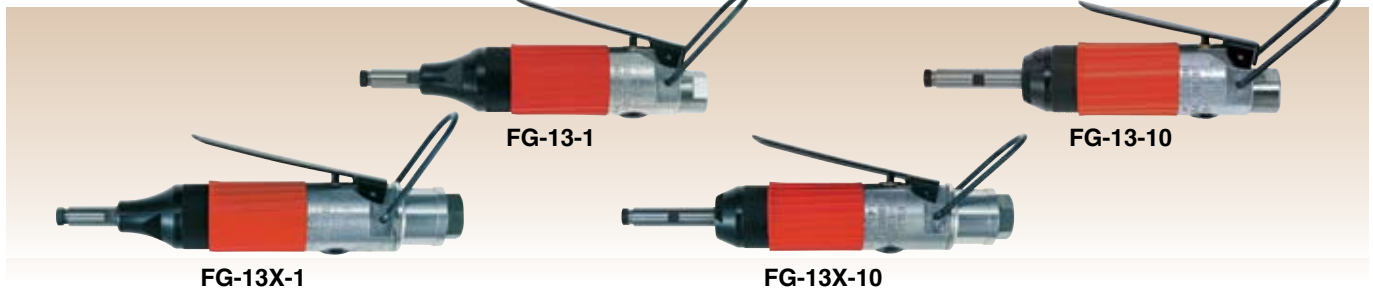

Model	Collet Size		Max. Dia.				Rotational Frequency	Overall Length		Mass		Max. Air Consumption		Air Hose Size	
	mm	in	Mounted Wheel		Burr Head			mm	in	kg	lb	m ³ /min	ft ³ /min	mm	in
Front Exhaust Type															
FG-13-1	3	1/8	13	1/2	10	3/8	30,000	158	6 7/32	0.3	0.9	0.25	8.8	6.3	1/4
FG-13-10	3	1/8	13	1/2	10	3/8	30,000	158	6 7/32	0.4	0.9	0.25	8.8	6.3	1/4
Rear Exhaust Type															
FG-13X-1	3	1/8	13	1/2	10	3/8	30,000	183	7 13/64	0.4	0.9	0.25	8.8	6.3	1/4
FG-13X-10	3	1/8	13	1/2	10	3/8	30,000	183	7 13/64	0.4	0.9	0.21	7.4	6.3	1/4

*Air Inlet Thread Size: PT or NPT 1/4".

Locking Lever Handle Models

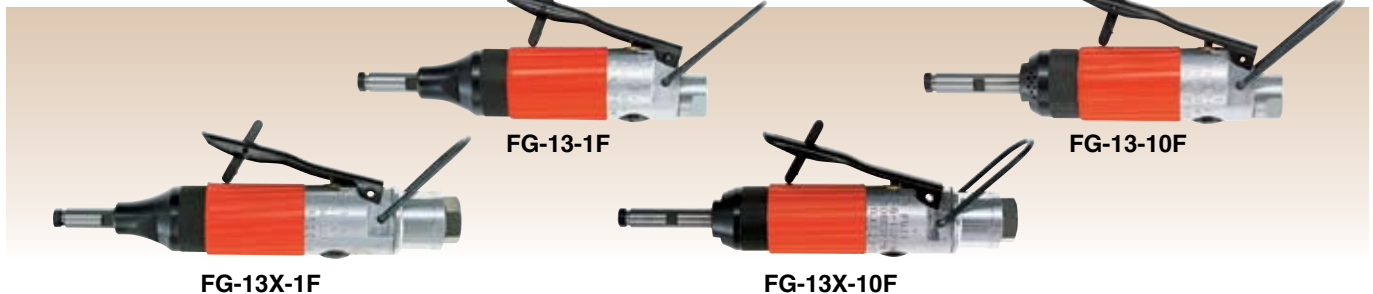

Model	Collet Size		Max. Dia.				Rotational Frequency	Overall Length		Mass		Max. Air Consumption		Air Hose Size	
	mm	in	Mounted Wheel		Burr Head			mm	in	kg	lb	m ³ /min	ft ³ /min	mm	in
Front Exhaust Type															
FG-13-1F	3	1/8	13	1/2	10	3/8	30,000	158	6 7/32	0.3	0.6	0.25	8.8	6.3	1/4
FG-13-10F	3	1/8	13	1/2	10	3/8	30,000	158	6 7/32	0.4	0.9	0.25	8.8	6.3	1/4
Rear Exhaust Type															
FG-13X-1F	3	1/8	13	1/2	10	3/8	30,000	183	7 13/64	0.4	0.9	0.25	8.8	6.3	1/4
FG-13X-10F	3	1/8	13	1/2	10	3/8	30,000	183	7 13/64	0.4	0.9	0.21	7.4	6.3	1/4

*Air Inlet Thread Size: PT or NPT 1/4".

Die Grinders

Roll Handle Models



FG-26-20, 50-2



FG-26X-20, 50X-2

Model	Collet Size		Max. Dia				Rotational Frequency	Overall Length		Mass		Max. Air Consumption		Air Inlet Thread Size	Air Hose Size	
	mm	in	Mounted Wheel		Burr Head			mm	in	kg	lb	m ³ /min	ft ³ /min		PT or NPT	mm
·Front or Side Exhaust Type																
FG-26-20	6	1/4	25	1	13	1/2	24,000	171	6 47/64	0.6	1.3	0.40	14.1	1/4	9.5	3/8
FG-50-2	6	1/4	32	1 1/4	22	7/8	18,000	180	7 3/32	0.8	1.8	0.43	15.2	1/4	9.5	3/8
Rear Exhaust Type																
FG-26X-20	6	1/4	25	1	13	1/2	24,000	211	8 5/16	0.7	1.5	0.40	14.1	1/4	9.5	3/8
FG-50X-2	6	1/4	32	1 1/4	22	7/8	18,000	218	8 37/64	0.9	2.0	0.45	15.8	1/4	9.5	3/8

• Specify front or side exhaust when ordering.

Lever Handle Models



FG-26-10, 50-1



FG-26X-10, 50X-1

Model	Collet Size		Max. Dia				Rotational Frequency	Overall Length		Mass		Max. Air Consumption		Air Inlet Thread Size	Air Hose Size	
	mm	in	Mounted Wheel		Burr Head			mm	in	kg	lb	m ³ /min	ft ³ /min		PT or NPT	mm
·Front or Side Exhaust Type																
FG-26-10	6	1/4	25	1	13	1/2	24,000	179	7 3/64	0.5	1.1	0.40	14.1	1/4	9.5	3/8
FG-50-1	6	1/4	32	1 1/4	22	7/8	18,000	191	7 33/64	0.8	1.8	0.43	15.2	1/4	9.5	3/8
Rear Exhaust Type																
FG-26X-10	6	1/4	25	1	13	1/2	24,000	206	8 7/64	0.6	1.3	0.40	14.1	1/4	9.5	3/8
FG-50X-1	6	1/4	32	1 1/4	22	7/8	18,000	214	8 27/64	0.7	1.5	0.45	15.8	1/4	9.5	3/8

• Specify front or side exhaust when ordering.

Locking Lever Handle Models



FG-26-20BF, 50-2BF



FG-26-10F, 50-1F



FG-26X-10F, 50X-1F

Model	Collet Size		Max. Dia				Rotational Frequency	Overall Length		Mass		Max. Air Consumption		Air Inlet Thread Size	Air Hose Size	
	mm	in	Mounted Wheel		Burr Head			mm	in	kg	lb	m ³ /min	ft ³ /min		PT or NPT	mm
·Front or Side Exhaust Type																
FG-26-20BF	6	1/4	25	1	13	1/2	24,000	180	7 3/32	0.7	1.5	0.40	14.1	1/4	9.5	3/8
FG-26-10F	6	1/4	25	1	13	1/2	24,000	179	7 3/64	0.5	1.1	0.40	14.1	1/4	9.5	3/8
FG-50-2BF	6	1/4	32	1 1/4	22	7/8	18,000	189	7 7/16	0.8	1.8	0.43	15.2	1/4	9.5	3/8
FG-50-1F	6	1/4	32	1 1/4	22	7/8	18,000	191	7 33/64	0.8	1.8	0.43	15.2	1/4	9.5	3/8
Rear Exhaust Type																
FG-26X-10F	6	1/4	25	1	13	1/2	24,000	206	8 7/64	0.6	1.3	0.40	14.1	1/4	9.5	3/8
FG-50X-1F	6	1/4	32	1 1/4	22	7/8	18,000	214	8 27/64	0.7	1.5	0.45	15.8	1/4	9.5	3/8

• Specify front or side exhaust when ordering.

FG-12U series, FG-25D series and FG-50D series Die Grinders are featured with an ergonomic spindle design supported by double bearings and connected to the motor spindle via a coupling. This design provides lower vibration, lower contact shock against the work piece, high accuracy and manoeuvrability.

Roll Handle Models



Model	Collet Size		Max. Dia.				Rotational Frequency	Overall Length		Mass		Max. Air Consumption		Air Hose Size	
	mm	in	Mounted Wheel		Burr Head			mm	in	kg	lb	m³/min	ft³/min	mm	in
Side Exhaust Type															
FG-12U-2	3,6	1/8, 1/4	13	1/2	8	5/16	43,000	190	7 31/64	0,6	1,3	0,30	10,6	6,3	1/4
FG-25D-2	3,6	1/8, 1/4	25	1	13	1/2	24,000	202	7 61/64	0,8	1,8	0,40	14,1	9,5	3/8
FG-50D-2	3,6	1/8, 1/4	32	1 1/4	22	7/8	18,000	213	8 25/64	0,9	2,0	0,45	15,9	9,5	3/8
Rear Exhaust Type															
FG-12UX-2	3,6	1/8, 1/4	13	1/2	8	5/16	43,000	211	8 5/16	0,7	1,5	0,30	10,6	6,3	1/4
FG-25DX-2	3,6	1/8, 1/4	25	1	13	1/2	24,000	227	8 15/16	0,8	1,8	0,40	14,1	9,5	3/8
FG-50DX-2	3,6	1/8, 1/4	32	1 1/4	22	7/8	18,000	237	9 21/64	1,0	2,2	0,45	15,9	9,5	3/8

*Air Inlet Thread Size: PT or NPT 1/4".

Lever Handle Models



Model	Collet Size		Max. Dia.				Rotational Frequency	Overall Length		Mass		Max. Air Consumption		Air Hose Size	
	mm	in	Mounted Wheel		Burr Head			mm	in	kg	lb	m³/min	ft³/min	mm	in
Side Exhaust Type															
FG-12U-1	3,6	1/8, 1/4	13	1/2	8	5/16	43,000	188	7 13/32	0,6	1,3	0,30	10,6	6,3	1/4
FG-25D-1	3,6	1/8, 1/4	25	1	13	1/2	24,000	198	7 51/64	0,8	1,8	0,40	14,1	9,5	3/8
FG-50D-1	3,6	1/8, 1/4	32	1 1/4	22	7/8	18,000	210	8 17/64	0,9	2,0	0,45	15,9	9,5	3/8
Rear Exhaust Type															
FG-12UX-1	3,6	1/8, 1/4	13	1/2	8	5/16	43,000	213	8 25/64	0,7	1,5	0,30	10,6	6,3	1/4
FG-25DX-1	3,6	1/8, 1/4	25	1	13	1/2	24,000	230	9 1/16	0,8	1,8	0,40	14,1	9,5	3/8
FG-50DX-1	3,6	1/8, 1/4	32	1 1/4	22	7/8	18,000	243	9 9/16	0,9	2,0	0,45	15,9	9,5	3/8

*Air Inlet Thread Size: PT or NPT 1/4".

Locking Lever Handle Models



Model	Collet Size		Max. Dia.				Rotational Frequency	Overall Length		Mass		Max. Air Consumption		Air Hose Size	
	mm	in	Mounted Wheel		Burr Head			mm	in	kg	lb	m³/min	ft³/min	mm	in
Side Exhaust Type															
FG-12U-1F	3,6	1/8, 1/4	13	1/2	8	5/16	43,000	188	7 13/32	0,6	1,3	0,30	10,6	6,3	1/4
FG-25D-1F	3,6	1/8, 1/4	25	1	13	1/2	24,000	198	7 51/64	0,8	1,8	0,40	14,1	9,5	3/8
FG-50D-1F	3,6	1/8, 1/4	32	1 1/4	22	7/8	18,000	210	8 17/64	0,9	2,0	0,45	15,9	9,5	3/8
Rear Exhaust Type															
FG-12UX-1F	3,6	1/8, 1/4	13	1/2	8	5/16	43,000	213	8 25/64	0,7	1,5	0,30	10,6	6,3	1/4
FG-25DX-1F	3,6	1/8, 1/4	25	1	13	1/2	24,000	230	9 1/16	0,8	1,8	0,40	14,1	9,5	3/8
FG-50DX-1F	3,6	1/8, 1/4	32	1 1/4	22	7/8	18,000	243	9 9/16	0,9	2,0	0,45	15,9	9,5	3/8

*Air Inlet Thread Size: PT or NPT 1/4".

Die Grinders

EXTENDED TYPE MODELS

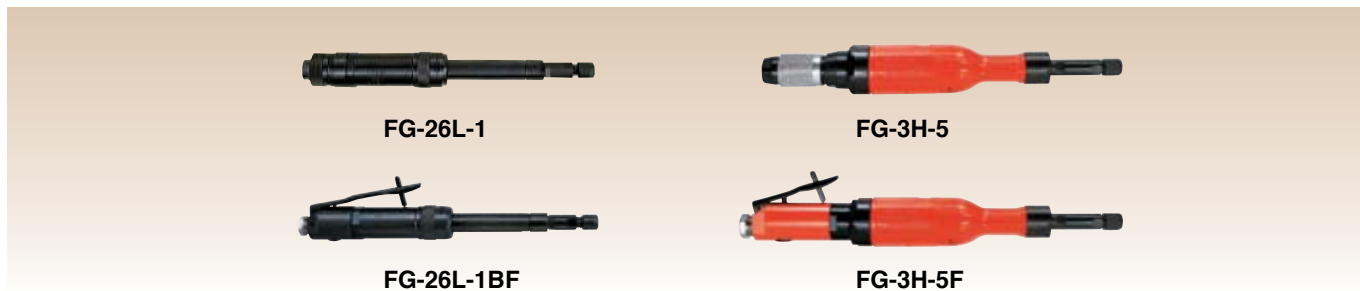

Model	Collet Size		Max. Dia. (Mounted Wheel)		Rotational Frequency	Spindle Thread Size	Overall Length		Mass		Max. Air Consumption		Air Hose Size	
	mm	in	mm	in			mm	in	kg	lb	m ³ /min	ft ³ /min	mm	in
Roll Handle Models														
FG-26L-1	6	1/4	25 x 13 x –	1 x 1/2 x –	24,000	5/16–24UNF	297	11 11/16	0.8	1.8	0.40	14.1	9.5	3/8
•FG-3H-5	6	1/4	45 x 13 x –	1 25/32 x 1/2 x –	14,600	3/8–24UNF	342	13 15/32	1.3	2.8	0.55	19.4	9.5	3/8
Locking Lever Handle Models														
FG-26L-1BF	6	1/4	25 x 13 x –	1 x 1/2 x –	24,000	5/16–24UNF	306	12 3/64	0.9	2.0	0.40	14.1	9.5	3/8
FG-3H-5F	6	1/4	45 x 13 x –	1 25/32 x 1/2 x –	14,600	3/8–24UNF	367	14 29/64	1.5	3.3	0.55	19.4	9.5	3/8

*Air Inlet Thread Size: PT or NPT 1/4", FG-3H-5, 5F: PT or NPT 3/8".

*Model Marked • is Locking Roll Handle type.

ANGLE TYPE MODELS



Side Exhaust Type

Model	Collet Size		Max. Dia. (Mounted Wheel)		Rotational Frequency	Spindle Thread Size	Overall Length		Mass		Max. Air Consumption		Air Hose Size	
	mm	in	mm	in			mm	in	kg	lb	m ³ /min	ft ³ /min	mm	in
Roll Handle Models														
FA-2C-2	6	1/4	38 x 13 x –	1 1/2 x 1/2 x –	15,000	3/8–24UNF(M)	157	6 3/16	0.6	1.3	0.40	14.1	9.5	3/8
FA-2C-3	6	1/4	38 x 13 x –	1 1/2 x 1/2 x –	15,000	W3/8–16(M)	157	6 3/16	0.6	1.3	0.40	14.1	9.5	3/8
Locking Lever Handle Models														
FA-2C-2BF	6	1/4	38 x 13 x –	1 1/2 x 1/2 x –	15,000	3/8–24UNF(M)	188	7 13/32	0.7	1.5	0.40	14.1	9.5	3/8
FA-2C-3BF	6	1/4	38 x 13 x –	1 1/2 x 1/2 x –	15,000	W3/8–16(M)	188	7 13/32	0.7	1.5	0.40	14.1	9.5	3/8

*Air Inlet Thread Size: PT or NPT 1/4".

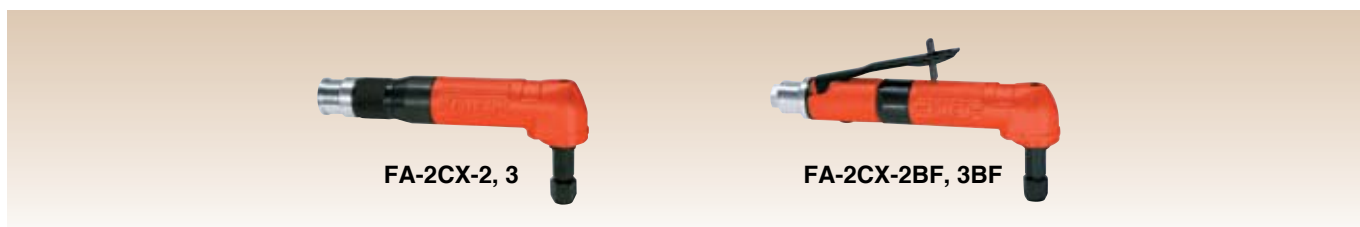

Rear Exhaust Type

Model	Collet Size		Max. Dia. (Mounted Wheel)		Rotational Frequency	Spindle Thread Size	Overall Length		Mass		Max. Air Consumption		Air Hose Size	
	mm	in	mm	in			mm	in	kg	lb	m ³ /min	ft ³ /min	mm	in
Roll Handle Models														
FA-2CX-2	6	1/4	38 x 13 x –	1 1/2 x 1/2 x –	15,000	3/8–24UNF(M)	197	7 3/4	0.7	1.5	0.40	14.1	9.5	3/8
FA-2CX-3	6	1/4	38 x 13 x –	1 1/2 x 1/2 x –	15,000	W3/8–16(M)	197	7 3/4	0.7	1.5	0.40	14.1	9.5	3/8
Locking Lever Handle Models														
FA-2CX-2BF	6	1/4	38 x 13 x –	1 1/2 x 1/2 x –	15,000	3/8–24UNF(M)	226	8 57/64	1.0	2.2	0.40	14.1	9.5	3/8
FA-2CX-3BF	6	1/4	38 x 13 x –	1 1/2 x 1/2 x –	15,000	W3/8–16(M)	226	8 57/64	1.0	2.2	0.40	14.1	9.5	3/8

*Air Inlet Thread Size: PT or NPT 1/4".

LOW SPEED GRINDERS

These powerful Grinders are designed with a gear reduction mechanism and speed control governor to maintain the power and rotational speed. Their light weight and compact design make them excellent for polishing, grinding, paint removal and can be used with non-woven cloth, brushes, flap wheels and buffs.

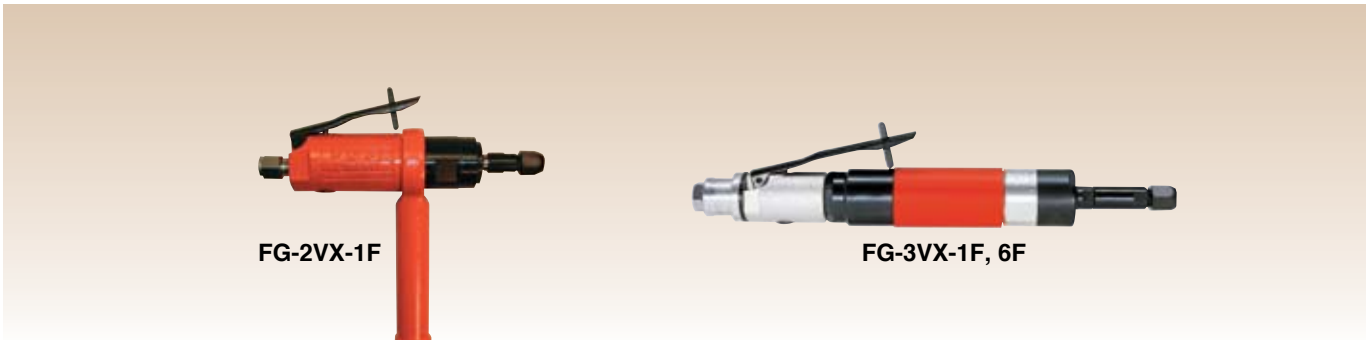

Model	Collet Size		Rotational Frequency min ⁻¹	Spindle Thread Size in	Overall Length		Mass		Max. Air Consumption		Air Inlet Thread Size PT or NPT	Air Hose Size	
	mm	in			mm	in	kg	lb	m ³ /min	ft ³ /min		mm	in
Locking Lever Handle / Rear Exhaust Models													
FG-2VX-1F	6	1/4	4,300	3/8-24UNF	216	8 1/2	0.9	2.0	0.34	12.0	1/4	9.5	3/8
FG-3VX-1F	6	1/4	7,600	W3/8-16	331	13 1/32	1.4	3.1	0.45	15.9	1/4	9.5	3/8
FG-3VX-6F	6	1/4	12,000	W3/8-16	331	13 1/32	1.4	3.1	0.47	16.6	1/4	9.5	3/8

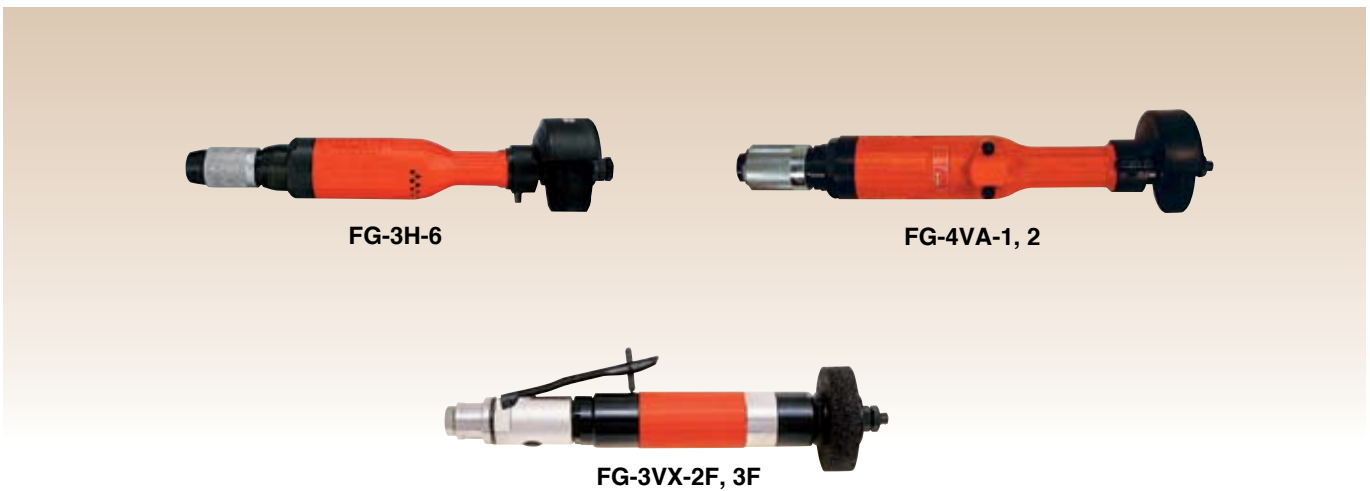

Model	Capacity		Rotational Frequency min ⁻¹	Wheel Thread Size in	Overall Length		Mass (with wheel guard)		Max. Air Consumption		Air Inlet Thread Size PT or NPT	Air Hose Size	
	mm	in			mm	in	kg	lb	m ³ /min	ft ³ /min		mm	in
Roll Handle / Side Exhaust Models													
FG-3H-6	65 x 25 x 9.5	2 1/2 x 1 x 3/8	9,700	W3/8-16	329	12 61/64	1.6	3.5	0.55	19.4	3/8	9.5	3/8
FG-4VA-1	75 x 13 x 9.5	3 x 1/2 x 3/8	7,500	W3/8-16	385	15 5/32	2.3	5.1	0.90	31.8	3/8	12.7	1/2
FG-4VA-2	100 x 19 x 12.7	4 x 3/4 x 1/2	6,300	W1/2-12	391	15 25/64	2.3	5.1	0.90	31.8	3/8	12.7	1/2
Locking lever Handle / Rear Exhaust Models													
FG-3VX-2F	75 x 19 x 9.5	3 x 3/4 x 3/8	9,500	W3/8-16	316	12 7/16	• 1.4	• 3.1	0.47	16.6	1/4	9.5	3/8
FG-3VX-3F	125 x 19 x 9.5	5 x 3/4 x 3/8	7,600	W3/8-16	316	12 7/16	• 1.4	• 3.1	0.45	15.9	1/4	9.5	3/8

*Models marked • are without wheel guard.

Straight Grinders

STRAIGHT GRINDERS

All Fuji Grinders are designed and produced using Fuji's latest grinder technology. Fuji Straight Grinders are equipped with centrifugal speed control governors, noise reducing design, and a locking handle. These standard features assure high performance and smooth operation.

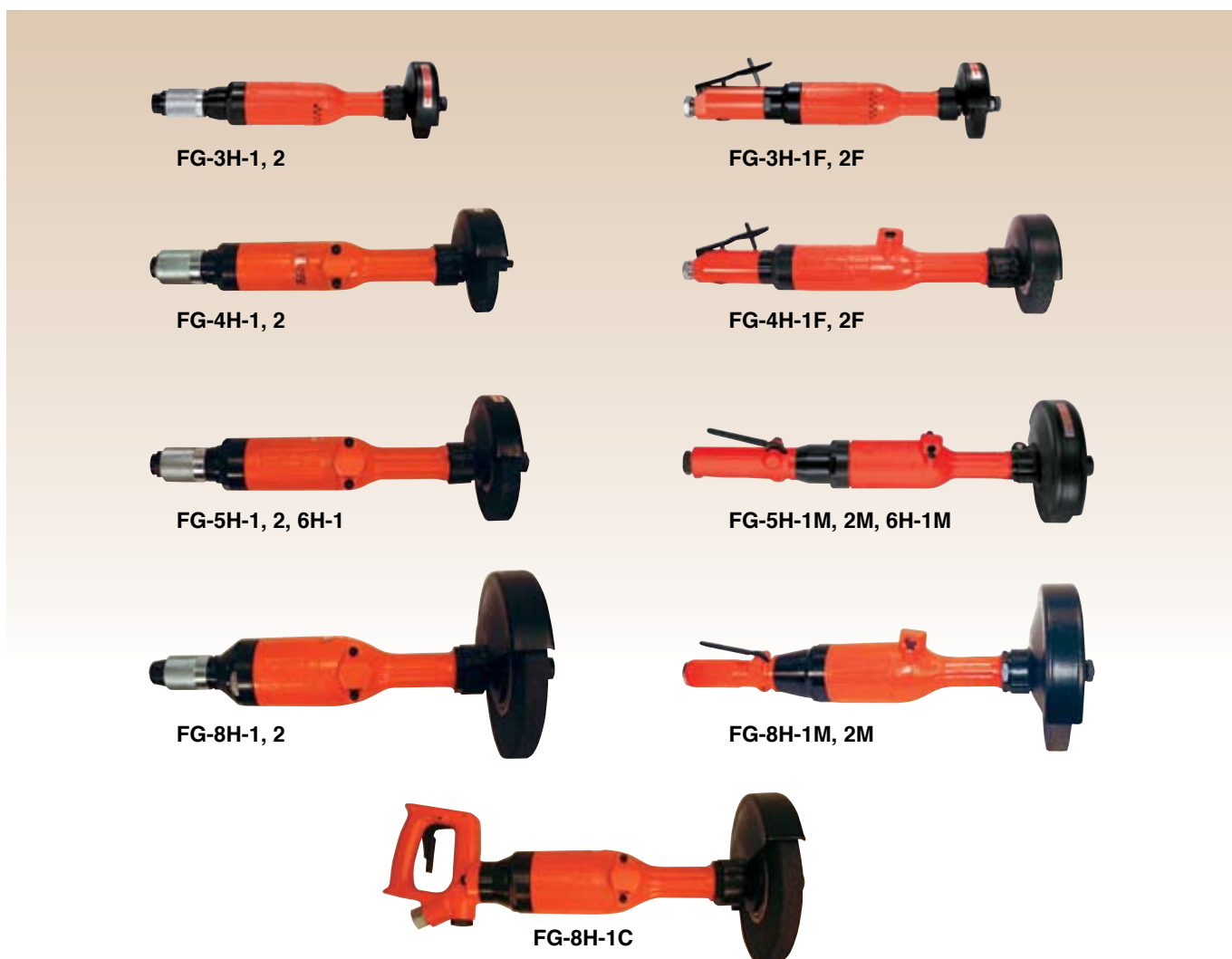

Model	Max. Dia. (Grinding Wheel)		Rotational Frequency min ⁻¹	Spindle Thread Size in	Overall Length		Mass		Max. Air Consumption		Air Inlet Thread Size PT or NPT	Air Hose Size	
	mm	in			mm	in	kg	lb	m ³ /min	ft ³ /min		mm	in
Roll Handle Models													
FG-3H-1	65 x 13 x 9.53	2 1/2 x 1/2 x 3/8	14,600	W3/8-16	317	12 31/64	1.5	3.3	0.55	19.4	3/8	9.5	3/8
FG-3H-2	75 x 13 x 9.53	3 x 1/2 x 3/8	12,700	W3/8-16	317	12 31/64	1.5	3.3	0.55	19.4	3/8	9.5	3/8
FG-4H-1	100 x 19 x 9.53	4 x 3/4 x 3/8	9,500	W3/8-16	385	15 5/32	2.2	4.8	0.80	28.2	3/8	12.7	1/2
FG-4H-2	100 x 19 x 12.7	4 x 3/4 x 1/2	9,500	W1/2-12	391	15 25/64	2.2	4.8	0.80	28.2	3/8	12.7	1/2
FG-5H-1	125 x 19 x 12.7	5 x 3/4 x 1/2	7,600	W1/2-12	405	15 15/16	2.7	5.9	1.00	35.3	3/8	12.7	1/2
FG-5H-2	125 x 19 x 15.8	5 x 3/4 x 5/8	7,600	5/8-11UNF	410	16 9/64	2.8	6.2	1.00	35.3	3/8	12.7	1/2
FG-6H-1	150 x 25 x 15.8	6 x 1 x 5/8	6,300	5/8-11UNF	434	17 5/64	3.5	7.7	1.20	42.4	3/8	12.7	1/2
FG-8H-1	205 x 25 x 15.8	8 x 1 x 5/8	4,600	5/8-11UNF	472	18 37/64	5.4	11.8	1.60	56.5	1/2	12.7	1/2
FG-8H-2	180 x 25 x 15.8	7 x 1 x 5/8	5,300	5/8-11UNF	472	18 37/64	5.3	11.7	1.80	63.5	1/2	12.7	1/2
Locking Lever Handle Models													
FG-3H-1F	65 x 13 x 9.53	2 1/2 x 1/2 x 3/8	14,600	W3/8-16	342	13 15/32	1.7	3.7	0.55	19.4	3/8	9.5	3/8
FG-3H-2F	75 x 13 x 9.53	3 x 1/2 x 3/8	12,700	W3/8-16	342	13 15/32	1.7	3.7	0.55	19.4	3/8	9.5	3/8
FG-4H-1F	100 x 19 x 9.53	4 x 3/4 x 3/8	9,500	W3/8-16	408	16 1/16	2.3	5.1	0.80	28.2	3/8	12.7	1/2
FG-4H-2F	100 x 19 x 12.7	4 x 3/4 x 1/2	9,500	W1/2-12	414	16 19/64	2.3	5.1	0.80	28.2	3/8	12.7	1/2
FG-5H-1M	125 x 19 x 12.7	5 x 3/4 x 1/2	7,600	W1/2-12	506	19 59/64	2.5	5.5	1.00	35.3	3/8	12.7	1/2
FG-5H-2M	125 x 19 x 15.8	5 x 3/4 x 5/8	7,600	5/8-11UNF	511	20 7/64	2.5	5.5	1.00	35.3	3/8	12.7	1/2
FG-6H-1M	150 x 25 x 15.8	6 x 1 x 5/8	6,300	5/8-11UNF	531	20 29/32	3.4	7.5	1.20	42.4	3/8	12.7	1/2
FG-8H-1M	205 x 25 x 15.8	8 x 1 x 5/8	4,600	5/8-11UNF	556	21 57/64	5.5	12.1	1.60	56.5	1/2	12.7	1/2
FG-8H-2M	180 x 25 x 15.8	7 x 1 x 5/8	5,300	5/8-11UNF	556	21 57/64	5.4	11.8	1.80	63.5	1/2	12.7	1/2
Grip Handle Models													
FG-8H-1C	205 x 25 x 15.8	8 x 1 x 5/8	4,600	5/8-11UNF	538	21 3/16	5.6	12.3	1.60	56.5	3/8	12.7	1/2

EXTENDED GRINDERS

Fuji Extended Grinders are ideal for grinding operations in confined spaces or inside pipes. A wide range of Grinders is offered to cover various grinding operations.



Model	Max. Dia. (Grinding Wheel)		Rotational Frequency	Spindle Thread Size	Overall Length		Mass		Max. Air Consumption		Air Hose Size	
	mm	in			mm	in	kg	lb	m ³ /min	ft ³ /min	mm	in
Roll Handle Models												
FG-50L-1	50 x 13 x 9.53	2 x 1/2 x 3/8	18,000	W3/8-16	307	12 3/32	1.4	3.1	0.43	15.2	9.5	3/8
FG-50Y-1	50 x 13 x 9.53	2 x 1/2 x 3/8	18,000	W3/8-16	523	20 19/32	2.0	4.4	0.43	15.2	9.5	3/8
FG-3HL-1	65 x 13 x 9.53	2 1/2 x 1/2 x 3/8	12,000	W3/8-16	522	20 35/64	1.9	4.2	0.55	19.4	9.5	3/8
FG-4HL-1	75 x 19 x 9.53	3 x 3/4 x 3/8	12,000	W3/8-16	585	23 1/32	2.7	5.9	0.80	28.2	12.7	1/2
FG-5HL-2	100 x 19 x 12.7	4 x 3/4 x 1/2	9,000	W1/2-12	953	37 33/64	5.3	11.7	1.00	35.3	12.7	1/2
Locking Lever Handle Models												
FG-50L-1BF	50 x 13 x 9.53	2 x 1/2 x 3/8	18,000	W3/8-16	316	12 7/16	1.4	3.1	0.43	15.2	9.5	3/8
FG-50Y-1BF	50 x 13 x 9.53	2 x 1/2 x 3/8	18,000	W3/8-16	532	20 15/16	2.0	4.4	0.43	15.2	9.5	3/8
FG-3HL-1F	65 x 13 x 9.53	2 1/2 x 1/2 x 3/8	12,000	W3/8-16	547	21 17/32	1.9	4.2	0.55	19.4	9.5	3/8
FG-4HL-1F	75 x 19 x 9.53	3 x 3/4 x 3/8	12,000	W3/8-16	615	24 7/32	2.6	5.7	0.80	28.2	12.7	1/2
FG-5HL-2M	100 x 19 x 12.7	4 x 3/4 x 1/2	9,000	W1/2-12	1,050	41 11/32	5.4	11.9	1.00	35.3	12.7	1/2

*FG-26L, 50L, 50Y series: 1/4" Air Inlet. FG-3HL, 4HL, 5HL series: 3/8" Air Inlet.

Angle Grinders

ANGLE GRINDERS

Fuji offers a wide variety of Angle Grinders for use in any grinding operation. Many models have features of machined bevel gears, speed control governor, built-in exhaust and a patented gear cooling design. Fuji has more models and variations than any other manufacturer.

Roll Handle Models



Model	Max. Dia. (Grinding Wheel)		Rotational Frequency	Spindle Thread Size	Angle Head Height		Overall Length		Mass		Max. Air Consumption		Air Hose Size	
	mm	in			mm	in	mm	in	kg	lb	m ³ /min	ft ³ /min	mm	in
Side Exhaust Type														
FA-2C-1	50 x 4 x 9.5	2 x 5/32 x 3/8	15,000	1/4-28UNF(F)	47	1 55/64	157	6 3/16	0.6	1.3	0.40	14.1	9.5	3/8
FA-3C-1	75 x 4 x 9.5	3 x 5/32 x 3/8	15,000	M8-1.25P(F)	63	2 31/64	180	7 3/32	1.1	2.4	0.40	14.1	9.5	3/8
FA-3C-2	100 x 6 x 15.8	4 x 1/4 x 5/8	13,500	M8-1.25P(F)	63	2 31/64	180	7 3/32	1.2	2.6	0.40	14.1	9.5	3/8
Rear Exhaust Type														
FA-2CX-1	50 x 4 x 9.5	2 x 5/32 x 3/8	15,000	1/4-28UNF(F)	47	1 55/64	197	7 3/4	0.7	1.5	0.40	14.1	9.5	3/8
FA-3CX-1	75 x 4 x 9.5	3 x 5/32 x 3/8	15,000	M8-1.25P(F)	63	2 31/64	217	8 35/64	1.2	2.6	0.40	14.1	9.5	3/8
FA-3CX-2	100 x 6 x 15.8	4 x 1/4 x 5/8	13,500	M8-1.25P(F)	63	2 31/64	217	8 35/64	1.2	2.6	0.40	14.1	9.5	3/8

*Air Inlet Thread Size: PT or NPT 1/4".

Locking Lever Handle Models



Model	Max. Dia. (Grinding Wheel)		Rotational Frequency	Spindle Thread Size	Angle Head Height		Overall Length		Mass		Max. Air Consumption		Air Hose Size	
	mm	in			mm	in	mm	in	kg	lb	m ³ /min	ft ³ /min	mm	in
Side Exhaust Type														
FA-2C-1BF	50 x 4 x 9.5	2 x 5/32 x 3/8	15,000	1/4-28UNF(F)	47	1 55/64	188	7 13/32	0.7	1.5	0.40	14.1	9.5	3/8
FA-3C-1F	75 x 4 x 9.5	3 x 5/32 x 3/8	15,000	M8-1.25P(F)	63	2 31/64	190	7 31/64	1.1	2.4	0.40	14.1	9.5	3/8
FA-3C-2F	100 x 6 x 15.8	4 x 1/4 x 5/8	13,500	M8-1.25P(F)	63	2 31/64	190	7 31/64	1.2	2.6	0.40	14.1	9.5	3/8
Rear Exhaust Type														
FA-2CX-1BF	50 x 4 x 9.5	2 x 5/32 x 3/8	15,000	1/4-28UNF(F)	47	1 55/64	226	8 57/64	1.0	2.2	0.40	14.1	9.5	3/8
FA-3CX-1F	75 x 4 x 9.5	3 x 5/32 x 3/8	15,000	M8-1.25P(F)	63	2 31/64	247	9 3/4	1.3	2.9	0.40	14.1	9.5	3/8
FA-3CX-2F	100 x 6 x 15.8	4 x 1/4 x 5/8	13,500	M8-1.25P(F)	63	2 31/64	247	9 3/4	1.3	2.9	0.40	14.1	9.5	3/8

*Air Inlet Thread Size: PT or NPT 1/4".

Roll Handle Models



Model	Max. Dia. (Grinding Wheel)		Rotational Frequency	Angle Head Height		Overall Length		Mass		Max. Air Consumption		Air Hose Size	
	mm	in		mm	in	mm	in	kg	lb	m ³ /min	ft ³ /min	mm	in
M8-P1.25 Thread Female Spindle Type													
FA-4C-1	100 x 6 x 15.8	4 x 1/4 x 5/8	13,500	77	3 1/32	210	8 17/64	1.8	3.9	0.55	19.4	9.5	3/8
FA-4CH-1	100 x 6 x 15.8	4 x 1/4 x 5/8	13,500	77	3 1/32	216	8 1/2	2.0	4.4	0.65	23.0	9.5	3/8
FA-5E-1V	125 x 6 x 22.2	5 x 1/4 x 7/8	10,900	70	2 3/4	225	8 55/64	2.0	4.4	0.95	33.5	9.5	3/8
FA-5E-2V	125 x 6 x 22.2	5 x 1/4 x 7/8	12,000	70	2 3/4	225	8 55/64	1.9	4.2	0.95	33.5	9.5	3/8
FA-5E-3V	100 x 6 x 15.8	4 x 1/4 x 5/8	13,500	70	2 3/4	225	8 55/64	2.0	4.4	0.95	33.5	9.5	3/8

*Air Inlet Thread Size: PT or NPT 3/8".

Locking Lever Handle Models

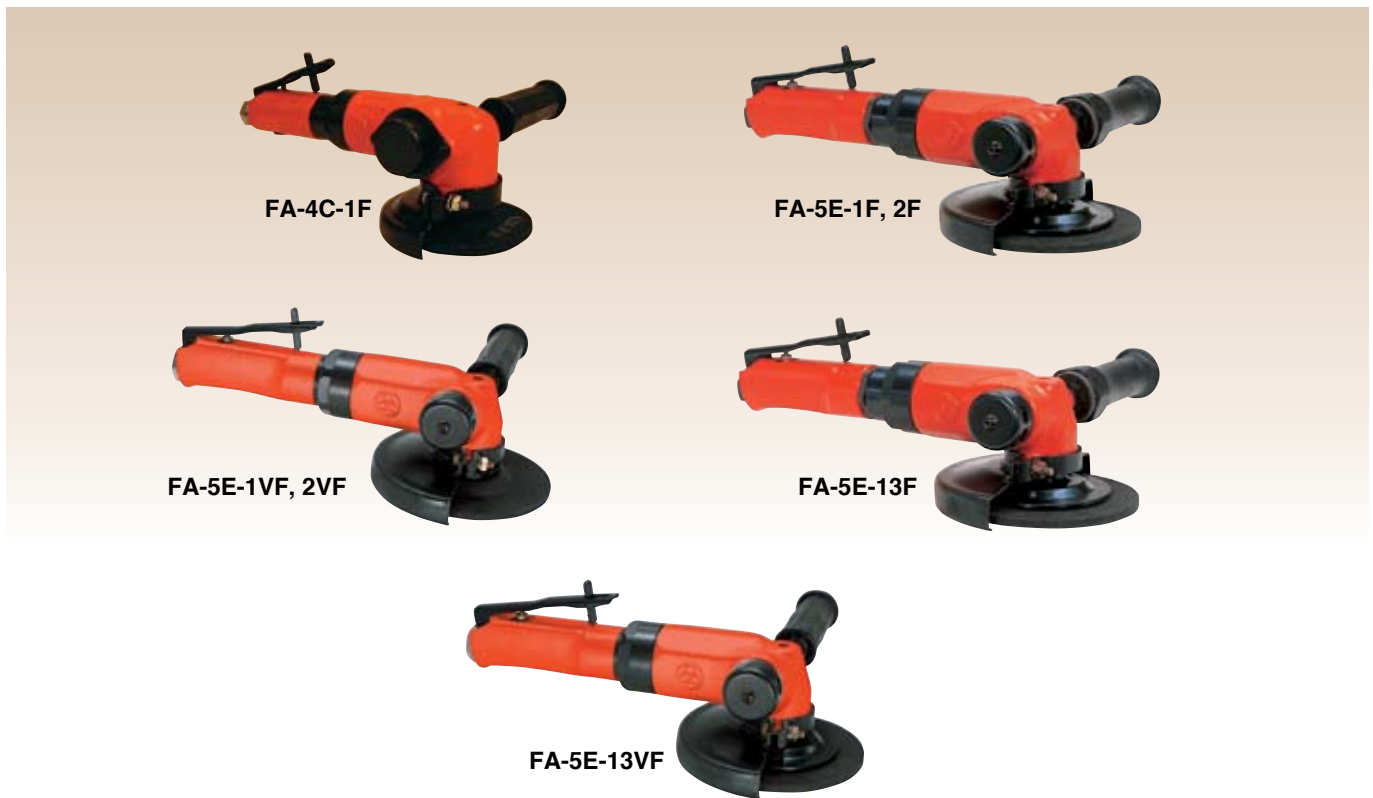

Model	Max. Dia. (Grinding Wheel)		Rotational Frequency	Angle Head Height		Overall Length		Mass		Max. Air Consumption		Air Hose Size	
	mm	in		mm	in	mm	in	kg	lb	m ³ /min	ft ³ /min	mm	in
M8-P1.25 Thread Female Spindle Type													
FA-4C-1F	100 x 6 x 15.8	4 x 1/4 x 5/8	13,500	77	3 1/32	240	9 29/64	1.9	4.2	0.55	19.4	9.5	3/8
FA-5E-1F	125 x 6 x 22.2	5 x 1/4 x 7/8	10,900	70	2 3/4	282	11 7/64	2.1	4.6	0.95	33.5	9.5	3/8
FA-5E-1VF	125 x 6 x 22.2	5 x 1/4 x 7/8	10,900	70	2 3/4	262	10 5/16	1.9	4.1	0.95	33.5	9.5	3/8
FA-5E-2F	125 x 6 x 22.2	5 x 1/4 x 7/8	12,000	70	2 3/4	282	11 7/64	2.1	4.6	0.95	33.5	9.5	3/8
FA-5E-2VF	125 x 6 x 22.2	5 x 1/4 x 7/8	12,000	70	2 3/4	262	10 5/16	1.9	4.1	0.95	33.5	9.5	3/8
3/8-24UNF Thread Male Spindle Type													
FA-5E-13F	125 x 6 x 22.2	5 x 1/4 x 7/8	12,000	75	2 61/64	282	11 7/64	2.2	4.8	0.95	33.5	9.5	3/8
FA-5E-13VF	125 x 6 x 22.2	5 x 1/4 x 7/8	12,000	75	2 61/64	262	10 5/16	2.2	4.8	0.95	33.5	9.5	3/8

*Air Inlet Thread Size: PT or NPT 3/8".

Angle Grinders

Roll Handle Models



Model	Max. Dia. (Grinding Wheel)		Rotational Frequency	Angle Head Height		Overall Length		Mass		Max. Air Consumption		Air Hose Size	
	mm	in		mm	in	mm	in	kg	lb	m ³ /min	ft ³ /min	mm	in
W1/2-16 Thread Female Spindle Type													
FA-6C-10	180 x 6 x 22.2	7 x 1/4 x 7/8	7,000	89	3 1/2	252	9 59/64	2.9	6.3	1.10	38.8	12.7	1/2
FA-6C-1	180 x 6 x 22.2	7 x 1/4 x 7/8	7,600	89	3 1/2	252	9 59/64	2.9	6.3	1.10	38.8	12.7	1/2
FA-6C-12	180 x 6 x 22.2	7 x 1/4 x 7/8	8,400	89	3 1/2	252	9 59/64	2.9	6.3	1.10	38.8	12.7	1/2
FA-7E-1V	180 x 6 x 22.2	7 x 1/4 x 7/8	7,000	87	3 27/64	272	10 45/64	3.1	6.8	1.40	49.4	12.7	1/2
FA-7E-2V	180 x 6 x 22.2	7 x 1/4 x 7/8	7,600	87	3 27/64	272	10 45/64	3.1	6.8	1.40	49.4	12.7	1/2
FA-7E-3V	180 x 6 x 22.2	7 x 1/4 x 7/8	8,400	87	3 27/64	272	10 45/64	3.1	6.8	1.40	49.4	12.7	1/2

*Air Inlet Thread Size: PT or NPT 3/8".

Locking Lever Handle Models



Model	Max. Dia. (Grinding Wheel)		Rotational Frequency	Angle Head Height		Overall Length		Mass		Max. Air Consumption		Air Hose Size	
	mm	in		mm	in	mm	in	kg	lb	m ³ /min	ft ³ /min	mm	in
W1/2-16 Thread Female Spindle Type													
FA-6C-12M	180 x 6 x 22.2	7 x 1/4 x 7/8	8,400	89	3 1/2	353	13 57/64	3.0	6.6	1.10	38.8	12.7	1/2
5/8-11UNC Thread Male Spindle Type													
FA-6C-9M	180 x 6 x 22.2	7 x 1/4 x 7/8	7,000	107	4 7/32	353	13 57/64	3.0	6.6	1.10	38.8	12.7	1/2
FA-6C-8M	180 x 6 x 22.2	7 x 1/4 x 7/8	7,600	107	4 7/32	353	13 57/64	3.0	6.6	1.10	38.8	12.7	1/2
FA-6C-6M	180 x 6 x 22.2	7 x 1/4 x 7/8	8,400	107	4 7/32	353	13 57/64	3.0	6.6	1.10	38.8	12.7	1/2
FA-7E-5VF	180 x 6 x 22.2	7 x 1/4 x 7/8	7,000	101	3 31/32	307	12 3/32	3.1	6.8	1.40	49.4	12.7	1/2
FA-7E-6VF	180 x 6 x 22.2	7 x 1/4 x 7/8	7,600	101	3 31/32	307	12 3/32	3.1	6.8	1.40	49.4	12.7	1/2
FA-7E-8VF	180 x 6 x 22.2	7 x 1/4 x 7/8	8,400	101	3 31/32	307	12 3/32	3.1	6.8	1.40	49.4	12.7	1/2

*Air Inlet Thread Size: PT or NPT 3/8".

Roll Handle / Locking Lever Handle Models



Model	Max. Dia. (Grinding Wheel)		Rotational Frequency min ⁻¹	Angle Head Height		Overall Length		Mass		Max. Air Consumption		Air Hose Size	
	mm	in		mm	in	mm	in	kg	lb	m ³ /min	ft ³ /min	mm	in
W1/2-16 Thread Female Spindle Type													
FA-9C-2	230 x 9.5 x 22.2	9 x 3/8 x 7/8	5,900	95	3 47/64	309	12 11/64	4.4	9.7	1.40	49.4	12.7	1/2
FA-9C-2M	230 x 9.5 x 22.2	9 x 3/8 x 7/8	5,900	95	3 47/64	385	15 5/32	4.5	9.9	1.40	49.4	12.7	1/2
5/8-11UNC Thread Male Spindle Type													
FA-9C-4	230 x 9.5 x 22.2	9 x 3/8 x 7/8	5,900	112	4 13/32	309	12 11/64	4.8	10.6	1.65	58.3	12.7	1/2
FA-9C-4M	230 x 9.5 x 22.2	9 x 3/8 x 7/8	5,900	112	4 13/32	385	15 5/32	4.8	10.6	1.65	58.3	12.7	1/2

*Air Inlet Thread Size: PT or NPT 1/2".

Roll Handle / Locking Lever Handle Models (110°, 120° Angle)



Model	Max. Dia. (Grinding Wheel)		Rotational Frequency min ⁻¹	Overall Length		Mass		Max. Air Consumption		Air Hose Size	
	mm	in		mm	in	kg	lb	m ³ /min	ft ³ /min	mm	in
M8-P1.25 Thread Female Spindle Type											
FA-3CK-2	100 x 6 x 15	4 x 1/4 x 5/8	13,500	164	6 29/64	1.2	2.6	0.40	14.1	9.5	3/8
FA-4CHK-1	100 x 6 x 15	4 x 1/4 x 5/8	13,500	220	8 43/64	2.0	4.4	0.65	22.9	9.5	3/8
W1/2-16 Thread Female Spindle Type											
FA-150KG-5	180 x 6 x 22.2	7 x 1/4 x 7/8	7,600	245	9 41/64	2.2	4.9	1.15	40.6	12.7	1/2

*Air Inlet Thread Size: PT or NPT 3/8", FA-3CK-2: PT or NPT 1/4".

Angle Sanders

ANGLE SANDERS

Roll Handle Models



Model	Max. Dia.				Rotational Frequency min ⁻¹	Overall Length		Mass		Max. Air Consumption		Air Hose Size	
	Sanding Disc		Wire Brush			mm	in	kg	lb	m ³ /min	ft ³ /min	mm	in
	mm	in	mm	in									
W1/2-16 Thread Female Spindle Type													
FA-5C-5	180 x - x 22.2	7 x - x 7/8	100 x - x 15.8	4 x - x 5/8	7,000	226	8 57/64	2.1	4.6	0.80	28.2	9.5	3/8
FA-6C-10	180 x - x 22.2	7 x - x 7/8	100 x - x 15.8	4 x - x 5/8	7,000	252	9 59/64	2.9	6.3	1.10	38.8	12.7	1/2
M8-P1.25 Thread Female Spindle Type													
FA-5E-7V	180 x - x 22.2	7 x - x 7/8	100 x - x 15.8	4 x - x 5/8	7,000	225	8 55/64	2.0	4.4	0.95	33.5	9.5	3/8

*Air Inlet Thread Size: PT or NPT 3/8". *Specify Sanding Discs or Wire Brushes when ordering.

Locking Lever Handle Models



Model	Max. Dia.				Rotational Frequency min ⁻¹	Overall Length		Mass		Max. Air Consumption		Air Hose Size	
	Sanding Disc		Wire Brush			mm	in	kg	lb	m ³ /min	ft ³ /min	mm	in
	mm	in	mm	in									
3/8-24UNF Thread Male Spindle Type													
FA-5E-6VF	180 x - x 22.2	7 x - x 7/8	100 x - x 15.8	4 x - x 5/8	6,000	262	10 5/16	2.0	4.4	0.95	33.5	9.5	3/8
5/8-11UNC Thread Male Spindle Type													
FA-6C-9M	180 x - x 22.2	7 x - x 7/8	100 x - x 15.8	4 x - x 5/8	7,000	353	13 57/64	3.0	6.6	1.10	38.8	12.7	1/2
FA-7E-5VF	180 x - x 22.2	7 x - x 7/8	100 x - x 15.8	4 x - x 5/8	7,000	307	12 3/32	3.1	6.8	1.40	49.4	12.7	1/2

*Air Inlet Thread Size: PT or NPT 3/8". *Specify Sanding Discs or Wire Brushes when ordering.

Angle Sanders/Angle Cutters/

Roll Handle / Locking Lever Handle Models (110°, 120° Angle)



Model	Max. Dia.				Rotational Frequency	Overall Length		Mass		Max. Air Consumption		Air Hose Size	
	Sanding Disc		Wire Brush			mm	in	kg	lb	m³/min	ft³/min	mm	in
	mm	in	mm	in									
W1/2-16 Thread Female Spindle Type													
FA-4CHK-3	150 x - x 22.2	6 x - x 7/8	125 x - x 15.8	5 x - x 5/8	8,400	230	9 3/64	1.8	4.0	0.65	22.9	9.5	3/8
FA-150K-2	150 x - x 22.2	6 x - x 7/8	125 x - x 15.8	5 x - x 5/8	8,400	210	8 17/64	1.6	3.5	1.00	35.3	12.7	1/2
FA-150K-3	150 x - x 22.2	6 x - x 7/8	125 x - x 15.8	5 x - x 5/8	8,400	210	8 17/64	1.8	4.0	1.00	35.3	12.7	1/2
FA-150KG-7	180 x - x 22.2	7 x - x 7/8	125 x - x 15.8	5 x - x 5/8	5,500	245	9 41/64	1.8	4.0	1.15	40.6	12.7	1/2
FA-4CHK-3F	150 x - x 22.2	6 x - x 7/8	125 x - x 15.8	5 x - x 5/8	8,400	259	10 13/64	1.8	4.0	0.65	22.9	9.5	3/8
3/8-24UNF Thread Male Spindle Type													
FA-3CK-1	100 x - x 15.9	4 x - x 5/8	-	-	11,000	164	6 29/64	1.1	2.4	0.40	33.5	9.5	3/8

*Air Inlet Thread Size: PT or NPT 3/8", FA-3CK-1: PT or NPT 1/4". *Specify Sanding Discs or Wire Brushes when ordering.

ANGLE CUTTERS

Roll Handle Models



Model	Max. Dia. (Cutter Blade)		Rotational Frequency	Overall Length		Mass		Max. Air Consumption		Air Hose Size	
	mm	in		mm	in	kg	lb	m³/min	ft³/min	mm	in
M8-P1.25 Thread Female Spindle Type											
FA-5E-8V	125 x 2 x 20	5 x 1/4 x 25/32	10,900	225	8 55/64	2.2	4.8	0.95	33.5	9.5	3/8
W1/2-16 Thread Female Spindle Type											
FA-6C-20	150 x 2 x 20	6 x 1/4 x 25/32	9,100	252	9 59/64	2.8	6.1	1.15	40.5	12.7	1/2
FA-7C-21	180 x 2 x 25.5	7 x 1/4 x 1	7,600	264	10 13/32	3.4	7.4	1.40	49.4	12.7	1/2

*Air Inlet Thread Size: PT or NPT 3/8".

DISC SANDER

This Sander features rear exhaust, low noise, high speed and comfortable design. It is useful for various sanding work.



Model	Max. Dia. (Sanding Disc)		Rotational Frequency	Height		Overall Length		Mass		Max. Air Consumption		Air Hose Size	
	mm	in		mm	in	mm	in	kg	lb	m³/min	ft³/min	mm	in
FG-5PX-1	125 x - x 22.2	5 x - x 7/8	12,000	170	6 11/16	108	4 1/4	1.0	2.2	0.50	17.7	9.5	3/8

*Air Inlet Thread Size: PT or NPT 1/4".

Vertical Grinders

VERTICAL GRINDERS

Fuji Vertical Grinders are very powerful due to their direct drive shafts. All vertical grinders feature a centrifugal speed control governor that maintains rotational frequency even under a heavy grinding load. All Models are 5/8"-11UNC male spindle type with locking lever handle.

Standard Type



FV-7-1M,4M

FV-9BH-1M

Model	Max.Dia. (Grinding Wheel)		Rotational Frequency	Height		Overall Length		Mass		Max. Air Consumption		Air Hose Size	
	mm	in		mm	in	mm	in	kg	lb	m ³ /min	ft ³ /min	mm	in
FV-7-1M	180 x 6 x 22.2	7 x 1/4 x 7/8	6,000	192	7 9/16	247	9 23/32	4.0	8.8	1.40	49.4	12.7	1/2
FV-7-4M	180 x 6 x 22.2	7 x 1/4 x 7/8	8,400	192	7 9/16	247	9 23/32	4.0	8.8	1.70	60.0	12.7	1/2
FV-9BH-1M	230 x 10 x 22.2	9 x 3/8 x 7/8	5,900	222	8 47/64	278	10 61/64	5.8	12.7	2.80	98.9	19.0	3/4

*Air Inlet Thread Size: PT or NPT 3/8", FV-9BH Series: PT or NPT 1/2".

Cup Wheel Type

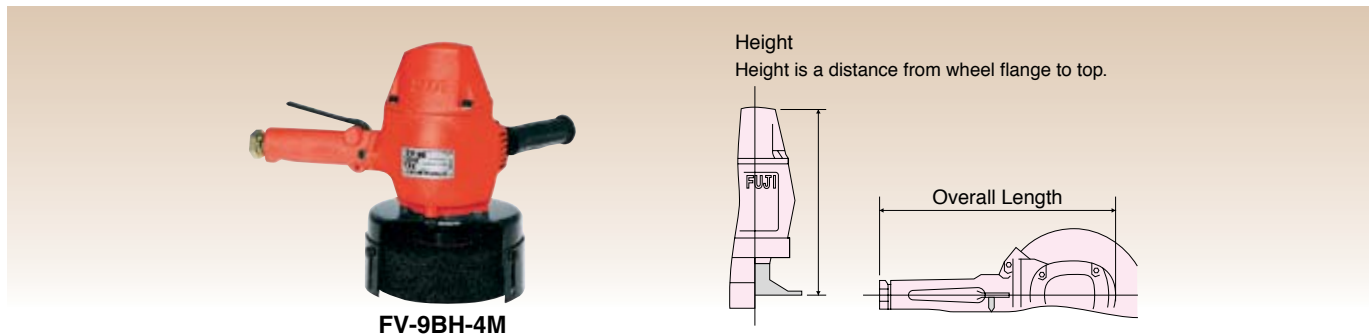

FV-9BH-4M

Model	Max.Dia. (Cup Wheel)		Rotational Frequency	Height		Overall Length		Mass		Max. Air Consumption		Air Hose Size	
	mm	in		mm	in	mm	in	kg	lb	m ³ /min	ft ³ /min	mm	in
FV-9BH-4M	150 x 50 x 22.2	6 x 2 x 7/8	4,500	204	8 1/32	278	10 61/64	6.1	13.4	2.40	84.7	19.0	3/4

*Air Inlet Thread Size: PT or NPT 1/2".

Sanding Disc Type



FV-7-2M

Model	Max.Dia. (Sanding Disc)		Rotational Frequency	Height		Overall Length		Mass		Max. Air Consumption		Air Hose Size	
	mm	in		mm	in	mm	in	kg	lb	m ³ /min	ft ³ /min	mm	in
FV-7-2M	180 x - x 22.2	7 x - x 7/8	7,000	192	7 9/16	247	9 23/32	4.0	8.8	1.60	56.5	12.7	1/2

*Air Inlet Thread Size: PT or NPT 3/8".

BELT SANDERS

Fuji Belt Sanders are ideal for precise and efficient sanding of confined areas such as spherical surfaces and tubes which are difficult to access with conventional grinders. They are also the ideal tool for de-burring applications. 360 degree head rotation provides versatile solution for almost any application.

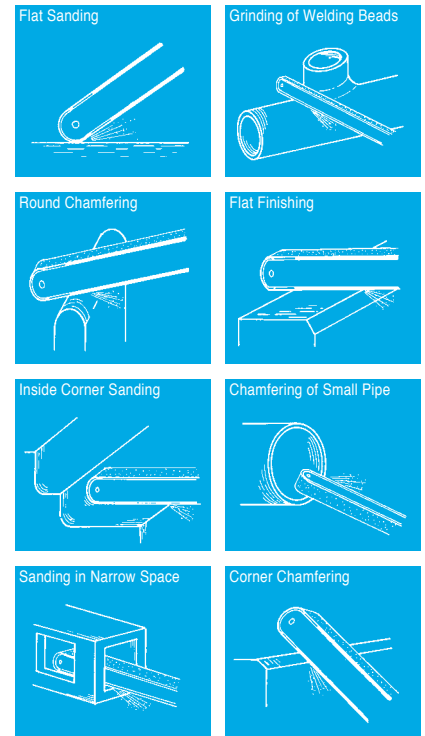

Model	Belt Size		Rotational Frequency min ⁻¹	Belt Speed m/min	Overall Length		Height		Mass		Max. Air Consumption		Air Hose Size	
	mm	in			mm	in	mm	in	kg	lb	m ³ /min	ft ³ /min	mm	in
FBS-1-1	10 x 330	13/32 x 12 1/64	20,000	1,200	281	11 5/64	124	4 57/64	1.1	2.4	0.57	20.1	9.5	3/8
FBS-1-2	20 x 520	51/64 x 19 1/2	20,000	1,200	375	14 25/32	124	4 57/64	1.2	2.6	0.57	20.1	9.5	3/8
FBS-1-3	13 x 460	33/64 x 18 1/8	20,000	1,200	345	13 19/32	124	4 57/64	1.2	2.6	0.57	20.1	9.5	3/8
FBS-1-4	20 x 460	51/64 x 18 1/8	20,000	1,200	345	13 19/32	124	4 57/64	1.2	2.6	0.57	20.1	9.5	3/8

*Air Inlet Thread Size: PT or NPT 1/4".

Sanding Belts



Sanding Belts in different size are able to be mounted to the tool by replacing Contact Arm Ass'y.

Applicable Model	Belt Size (mm)	Grit #40	Grit #60	Grit #80	Grit #100	Grit #120
FBS-1-1	10 x 330	DSB-271	DSB-273	•DSB-274	DSB-275	DSB-276
FBS-1-2	20 x 520	DSB-261	DSB-263	•DSB-264	DSB-265	DSB-266
FBS-1-3	13 x 460	DSB-221	DSB-223	•DSB-224	DSB-225	DSB-226
FBS-1-4	20 x 460	DSB-241	DSB-243	•DSB-244	DSB-245	DSB-246

*Marked • are Standard Accessories.

Contact Arm Ass'y

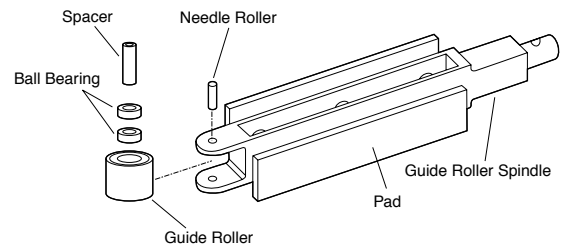

Contact Arm Ass'y	Size	Model
S-169044-00	10 x 330	FBS-1-1
S-169044-01	20 x 520	FBS-1-2
S-169044-02	13 x 460	FBS-1-3
S-169044-03	20 x 460	FBS-1-4

Orbital Sanders

ORBITAL SANDERS

Fuji Orbital Sanders are compact, lightweight & manoeuvrable, yet powerful enough for finishing lacquered and metal surfaces prior to re-painting. The effective dust extraction with rear exhaust helps keep the working environment clean.

Features

- Powerful sanding, high stability and low vibration.
- Excellent dust extraction ability to help keep the work area clean.
- Three throttle types; Cock Type for variable speed and two lever Types to accommodate operator preference.
- Available to suit variations of sandpapers; self-adhesive type, Velcro (Nylon Strip Fastener) Type and standard Clip-on Type.

Disc Type

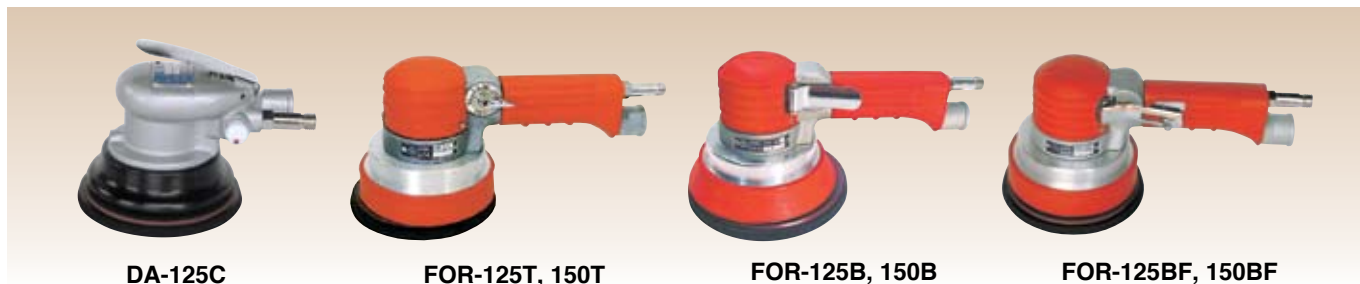

Model	Capacity (Sanding Disc)		Rotational Frequency	Angle Head Height		Overall Length		Mass		Max. Air Consumption		Air Hose Size	
	mm	in		mm	in	mm	in	kg	lb	m ³ /min	ft ³ /min	mm	in
Cock Handle Models													
DA-125T-E(M)	ø125	5	8,500	89	3 1/2	158	6 7/32	1.2	2.6	0.26	9.1	6.3	1/4
FOR-125T-E(M)	ø125	5	8,000	124	4 7/8	243	9 9/16	2.0	4.4	0.36	12.7	6.3	1/4
FOR-150T-E(M)	ø150	6	8,000	124	4 7/8	256	10 5/64	2.1	4.6	0.36	12.7	6.3	1/4
Lever Handle Models													
DA-125L-E(M)	ø125	5	8,500	94	3 45/64	158	6 7/32	1.2	2.6	0.26	9.1	6.3	1/4
DA-125C-E(M)	ø125	5	8,500	107	4 7/32	158	6 7/32	1.4	3.0	0.26	9.1	6.3	1/4
FOR-125B-E(M)	ø125	5	8,000	124	4 7/8	243	9 9/16	2.0	4.4	0.36	12.7	6.3	1/4
FOR-150B-E(M)	ø150	6	8,000	124	4 7/8	256	10 5/64	2.1	4.6	0.36	12.7	6.3	1/4
Locking Lever Handle Models													
FOR-125BF-E(M)	ø125	5	8,000	124	4 7/8	243	9 9/16	2.0	4.4	0.36	12.7	6.3	1/4
FOR-150BF-E(M)	ø150	6	8,000	124	4 7/8	256	10 5/64	2.1	4.6	0.36	12.7	6.3	1/4

*Air Inlet Thread Size: PT or NPT 1/4".

*Adhesive paper type: (E). *Velcro paper type: (M).

Rectangle Sheet Type



Model	Capacity (Sanding Pad Size)		Rotational Frequency	Angle Head Height		Overall Length		Mass		Max. Air Consumption		Air Hose Size	
	mm	in		mm	in	mm	in	kg	lb	m ³ /min	ft ³ /min	mm	in
Cock Handle Models													
OB-75T-E(M)	75 x 100	3 x 4	7,000	86	3 25/64	145	5 45/64	1.2	2.6	0.26	9.1	6.3	1/4
FOS-175T-E(M)	100 x 175	4 x 7	6,500	130	5 1/8	268	10 9/16	2.4	5.2	0.34	11.9	6.3	1/4
FOS-230T-E	100 x 230	4 x 9	6,000	130	5 1/8	291	11 29/64	2.6	5.7	0.34	11.9	6.3	1/4
FOS-400T-E	100 x 400	4 x 16	5,500	130	5 1/8	400	16	3.3	7.2	0.32	11.3	6.3	1/4
Lever Handle Models													
OB-75L-E(M)	75 x 100	3 x 4	7,000	91	3 37/64	145	5 45/64	1.2	2.6	0.26	9.1	6.3	1/4
OB-90L-E(M)	90 x 100	3.5 x 4	7,000	91	3 37/64	145	5 45/64	1.3	2.8	0.26	9.1	6.3	1/4
FOS-175B-E(M)	100 x 175	4 x 7	6,500	130	5 1/8	268	10 9/16	2.4	5.2	0.34	11.9	6.3	1/4
FOS-230B-E	100 x 230	4 x 9	6,000	130	5 1/8	291	11 29/64	2.6	5.7	0.34	11.9	6.3	1/4
FOS-400B-E	100 x 400	4 x 16	5,500	130	5 1/8	400	16	3.3	7.2	0.32	11.3	6.3	1/4
Locking Lever Handle Models													
FOS-175BF-E(M)	100 x 175	4 x 7	6,500	130	5 1/8	268	10 9/16	2.4	5.2	0.34	11.9	6.3	1/4
FOS-230BF-E	100 x 230	4 x 9	6,000	130	5 1/8	291	11 29/64	2.6	5.7	0.34	11.9	6.3	1/4
FOS-400BF-E	100 x 400	4 x 16	5,500	130	5 1/8	400	16	3.3	7.2	0.32	11.3	6.3	1/4

*Air Inlet Thread Size: PT or NPT 1/4".

*Adhesive paper type: (E). *Velcro paper type: (M).

ACCESSORIES PROVIDED



Model	Exhaust Hose	Dust Bag	Spanner	Punching Tool / Rod	Sanding Disc
DA-125(T, L, C)	●	●	● for DA-125C	-	● 2pcs.
FOR-125(T, B)	●	●	●	Rod	● 2pcs.
FOR-150(T, B)	●	●	●	Rod	● 2pcs.
OB-75(T, L)	●	●	-	●	-
OB-90L	●	●	-	-	-
FOS-175(T, B)	●	●	-	-	● 2pcs.
FOS-230(T, B)	●	●	-	●	● 2pcs.
FOS-400(T, B)	●	●	-	●	● 2pcs.

* ● = provided, - = not provided

HOLE PATTERN AND DIMENSIONS OF SANDING PAPERS AND PAD

Disc Type

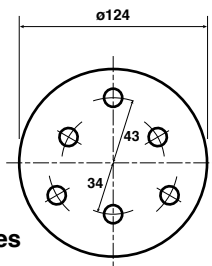

DA-125, FOR-125 Series

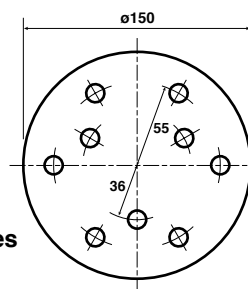

FOR-150 Series

Model	Adhesive Paper Type		Velcro Paper Type	
	Paper	Pad	Paper	Pad
DA-125	FOR-125-#40~#150	PAD-125E	FOR-125-M40~M600	PAD-125M
FOR-125	FOR-125-#40~#150	PAD-125E	FOR-125-M40~M600	PAD-125M
FOR-150	FOR-150-#40~#150	PAD-150E	FOR-150-M40~M600	PAD-150M

* Specify the grit when ordering sanding papers.

Rectangle Sheet Type

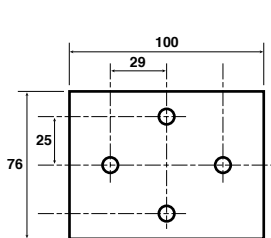

OB-75 Series

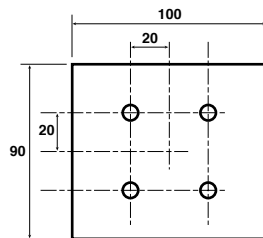

OB-90L

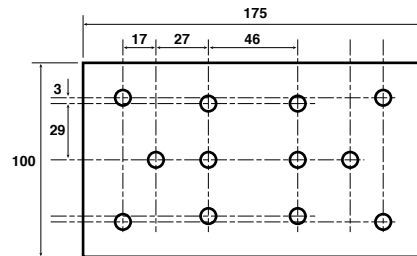

FOS-175 Series

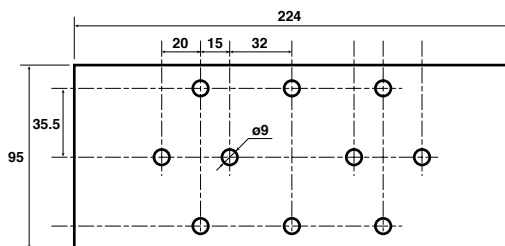

FOS-230 Series

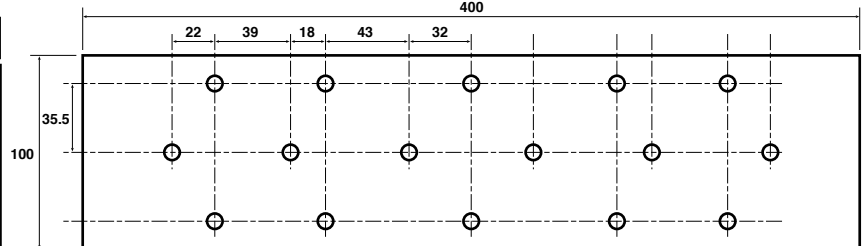

FOS-400 Series

Model	Adhesive Paper Type		Velcro Paper Type		Roll Paper (Clip-on type)
	Paper	Pad	Paper	Pad	
OB-75	OB-75-#40~#240	PAD-75E	OB-75-M40~M600	PAD-75M	-
OB-90	OB-90-#40~#240	PAD-90E	OB-90-M40~M600	PAD-90M	-
FOS-175	FOS-175-#40~#240	PAD-175E	FOS-175-M40~M600	PAD-175M	-
FOS-230	FOS-230-#40~#240	PAD-230E	-	-	FOS-230-C40~C240
FOS-400	FOS-400-#40~#240	PAD-400E	-	-	FOS-400-C40~C240

* Roll Paper Size: 100mm x 15m (Dimension: FOS-230(100 x 300)mm, FOS-400(100 x 470)mm.)

* Specify the grit when ordering sanding papers.

Accessories

COLLET BUSHES

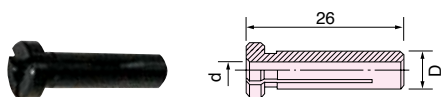

Parts No.	Size				Models
	D		d		
	mm	in	mm	in	
G-032347-00	6.0	-	3.0	-	FG-26, 26X, 26L, 50, 50L, 50Y Series
G-032347-02	6.0	-	-	1/8	FG-3H, 3HL, 4H, 4HL Series
G-032347-03	-	1/4	-	1/8	FA-2C-2, 2BF, 3, 3BF, 2CX-2, 2BF, 3, 3BF

*These collet bushes are used for collet chucks.

COLLET CHUCKS

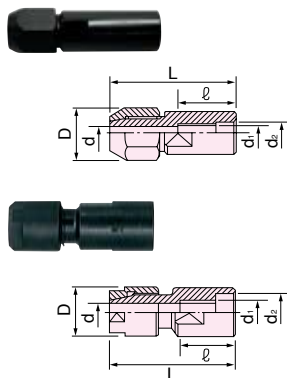

AC No.	Collet	Collet Nut	Size								Models	
			d		d1	D		L				
			mm	in		mm	in	mm	mm			
CN-1210	G-011342-00	G-162343-00	6	-	3/8-24UNF	-	3/8	17Hex	57	32	FG-50L-2, 2BF, 50Y-2, 2BF, 3HL-2, 2F, FG-4HL-2, 2F, 3H-5, 5F	
CN-1207	G-041342-00		-	1/4		-	3/8	17Hex	57	32		
CN-1402	G-017342-00		6	-	W3/8-16	-	3/8	17Hex	57	32	FG-50L-1, 1BF, 50Y-1, 1BF, 3HL-1, 1F, 4HL-1, 1F, 4H-1, 1F, FG-3VX-1F, 2F, 3F, 6F, 3H-1, 1F, 2, 2F, 6, 4VA-1, 50DX-5F	
CN-1404	G-017342-01		-	1/4		-	3/8	17Hex	57	32		
CN-1202	G-011342-00		6	-	3/8-24UNF	-	3/8	17Hex	42	17	FG-2VX-1F, FA-2C-2, 2BF, 2CX-2, 2BF	
CN-1208	G-028342-00		-	1/4		-	3/8	17Hex	42	17		
CN-1406	A-122342-01		6	-	W3/8-16	-	3/8	17Hex	42	17	FA-2C-3, 3BF, 2CX-3, 3BF	
CN-1407	A-122342-02		-	1/4		-	3/8	17Hex	42	17		
CN-1114	G-144342-03		G-144343-02	3	-	5/16-24UNF	12	-	14	44	21	FG-26, 26X, 26L, FG-50, 50X Series
CN-1115	G-144342-04			-	1/8				14	44	21	
CN-1112	G-144342-00	G-144343-00	6	-	5/16-24UNF	12	-	16	44	21		
CN-1113	G-144342-01		-	1/4				16	44	21		

COLLETS

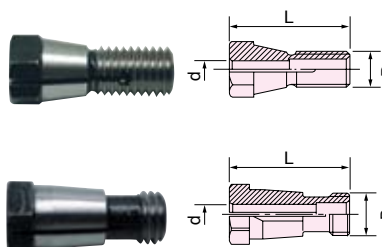

Parts No.	Size					Models
	d		D	Taper	L	
	mm	in				
G-001342-01	3.0	-	1/4-28UNF	3/10	20	TURBO-100
G-001342-02	-	1/8	1/4-28UNF	3/10	20	TURBO-100
G-002342-00	6.0	-	W11-24	2/5	23	TURBO-100A
G-002342-01	-	1/4	W11-24	2/5	23	TURBO-100A
G-185342-00	3.0	-	1/4-28UNF	-	18	FG-06-1
G-185342-01	-	1/8	1/4-28UNF	-	18	FG-13Series, 13XSeries

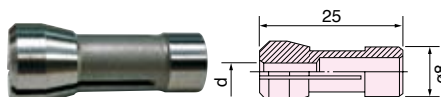

Parts No.	Size		Models
	d		
	mm	in	
G-028342-08	3.0	-	FG-12U, 12UX
G-028342-04	-	1/8	FG-25D, 25DX
G-028342-07	6.0	-	FG-50D, 50DX
G-028342-06	-	1/4	FG-50D, 50DX

CONE WHEEL

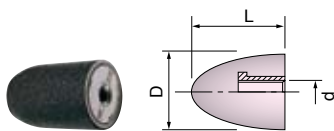

AC No.	Size			Material
	D	L	d	
	mm	mm		
124	38	65	W3/8-16	A-36P

ADAPTER FOR CONE WHEEL

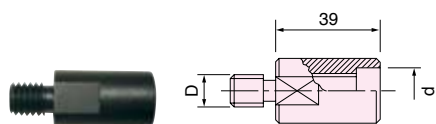

Part No.	Size	
	D	d
G-158309-00	W3/8-16	5/16-24UNF

SPACER FOR CONE WHEEL

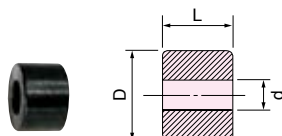

Part No.	Size			
	d		D	L
	mm	in	mm	mm
G-013308-00	9.53	3/8	20	13.5

CONE WHEEL APPLICATIONS

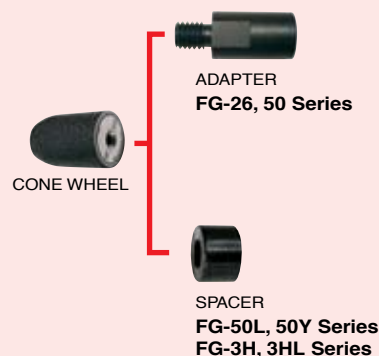

TUNGSTEN CARBIDE BURRS

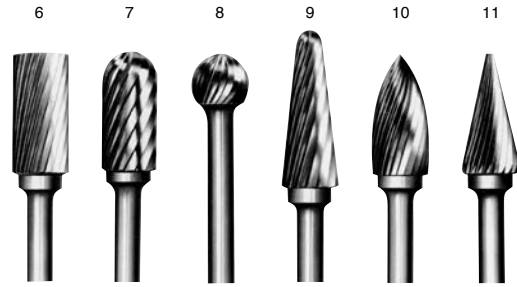
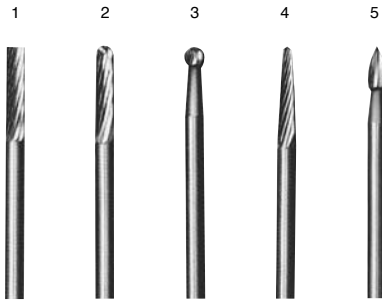

3mm Shank Dia

Index No.	AC No.	Size		Model
		Head Dia	Length	
		mm	in	
1	A03	3	38	FG-06-1
2	B03	3	38	TURBO-100
3	C03	3	38	FG-13-1F, 2
4	E03	3	38	FG-13X-1F, 2
5	F03	3	38	

6mm Shank Dia

Index No.	AC No.	Size		Model
		Head Dia	Length	
		mm	in	
6	A08(A13)	8(13)	55(70)	TURBO-100A
7	B08(B13)	8(13)	55(75)	FG-12U, 25D, 50D Series
8	C08(C13)	8(13)	55(60)	FG-12UX, 25DX Series
9	E08(E13)	8(13)	55(84)	FG-50DX Series
10	F08(F13)	8(13)	55(75)	(except FG-50DX-5F)
11	H08(H13)	8(13)	55(70)	

MOUNTED WHEELS

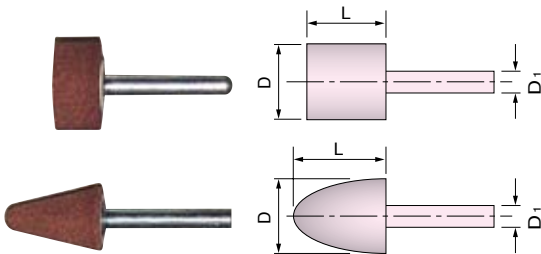

Type	AC No.	Size			Material	Model
		D	L	D ₁		
		mm	mm	mm		
Straight	103	10	10	3	WA-60	FG-13, 13X Series FG-12U, 12UX Series FG-25, 25DX, 50D, 50DX Series FG-12U, 12UX, 26, 26L, 26X, 50, 50X Series FG-25D, 25DX, 50D, 50DX Series, 3H-5, 5F FG-3VX-6F, FA-2C-2, 3, 2CX-2, 3 Series
	105	25	13	6		
Cone	111	10	15	3	WA-60	FG-13, 13X Series FG-12U, 12UX Series FG-25, 25DX, 50D, 50DX Series FG-12U, 12UX, 26, 26L, 26X, 50, 50X Series FG-25D, 25DX, 50D, 50DX Series, 3H-5, 5F FG-3VX-6F, FA-2C-2, 3, 2CX-2, 3 Series
	113	19	25	6		

*Minimum order required :100pcs. / item

SHANK BRUSH

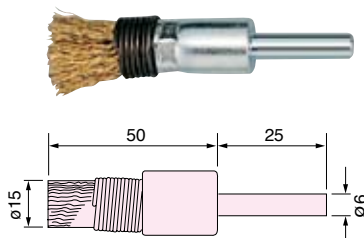

AC No.	Rotational Frequency	Models
	min ⁻¹	
170	15,000	FG-3VX-6F, 3H-5, 5F FA-2C-2, 2BF, 3, 3BF FA2CX-2, 2BF, 3, 3BF

Accessories

RADIAL WIRE BRUSHES

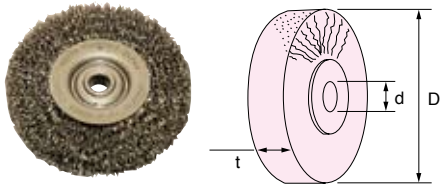
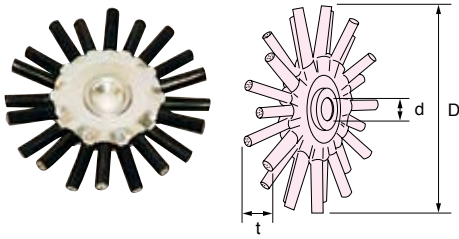

AC No.	Size			Maximum Rotational Frequency min ⁻¹	Models
	D mm	t mm	d mm		
KWH-100WK5	100	13	10	12,000	FG-4H-1, 1F
KWH-123WK5	125	14	16	9,500	FG-5H-2, FA-150K-2,3, 150KG-7
KWH-156WK5	150	17	16	7,500	FG-6H-1, 1M

*Minimum order required :10pcs. / item.

AC No.	Size			Maximum Rotational Frequency min ⁻¹	Models
	D mm	t mm	d mm		
181	50	13	10	18,000	FG-50L, 50Y
182	65	13	10	15,000	FG-3H-1, 1F, 3HL-1, 1F
183	75	13	10	13,000	FG-3H-2, 2F, 4HL-1, 1F
184	100	13	10	9,500	FG-4H-1, 1F
184-2	100	13	13	9,500	FG-4H-2, 2F, 5HL-2, 2M
185	125	19	16	7,600	FG-5H-2, 2M
185-2	125	19	13	7,600	FG-5H-1, 1M
186	150	25	16	6,300	FG-6H-1, 1M
187	205	25	16	4,600	FG-8H-1, 1C, 1M

*Minimum order required :10pcs. / item.

STRAIGHT GRINDING WHEELS FOR STRAIGHT AND EXTENSION GRINDERS

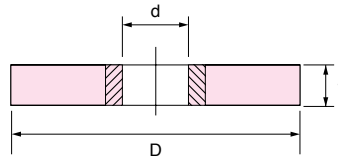

AC No.	Size						Material	Maximum Rotational Frequency min ⁻¹	Models
	D		t		d				
	mm	in	mm	in	mm	in			
131	50	2	13	1/2	9.53	3/8	A-36Q	18,000	FG-50L, -50Y Series
132	65	2 1/2	13	1/2	9.53	3/8	A-30R	14,000	FG-3H-1, 1F, 3HL-1, 1F, 2, 2F
133	75	3	13	1/2	9.53	3/8	A-24P	12,000	FG-3H-2, 2F, 4HL-1, 1F, 2, 2F
133-1	75	3	19	3/4	9.53	3/8	A-24P	12,000	FG-4HL-1, 1F, 2, 2F
134	100	4	19	3/4	9.53	3/8	A-24P	9,000	FG-4H-1, 1F
136-2	125	5	19	3/4	12.70	1/2	A-24P	7,600	FG-5H-1, 1M
137	125	5	19	3/4	15.88	5/8	A-24P	7,600	FG-5H-2, 2M
138	150	6	25	1	15.88	5/8	A-24P	6,300	FG-6H-1, 1M
139	180	7	25	1	15.88	5/8	A-24P	5,300	FG-8H-2 Series
140	205	8	25	1	15.88	5/8	A-24P	4,600	FG-8H-1 Series

** = Minimum order required :100pcs. / item, others = Minimum order required : 50pcs. / item.

HEAT SHRINK-TUBES FOR EXTENSION GRINDERS



- Comfort grip to soften application vibration and warm to touch.
- Tube diameter will shrink to half size when heated to 120°C.
- Cut to suitable size to fit the tool.

AC No.	Length m	Before	After		Object Size mm	Models
		Inside Diameter mm	Inside Diameter mm	Thickness mm		
M20-10-1	5	20	10	1	12~17	FG-06
M20-10-2	5	20	10	2	12~17	
M30-15-1	5	30	15	1	18~27	FG-26L
M30-15-2	5	30	15	2	18~27	
M40-20-1	5	40	20	1	23~35	FG-50, 3HL
M40-20-2	5	40	20	2	23~35	
M50-25-2	5	50	25	2	28~45	FG-4HL
M50-25-3	5	50	25	3	28~45	
M60-30-2	5	60	30	2	35~55	FG-5HL
M60-30-3	5	60	30	3	35~55	

ACCESSORIES FOR FA-2C, -2CX SERIES

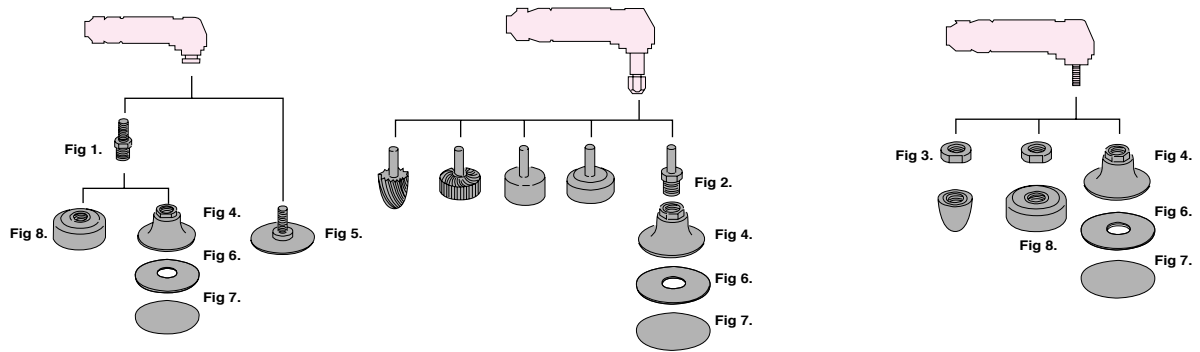

ATTACHMENTS

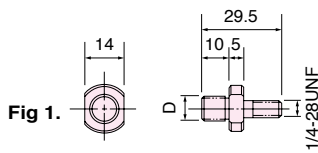

Parts No.	Size	Models
	D	
A-122693-00	W3/8-24	FA-2C-1, 1BF
A-122693-01	W3/8-16	FA-2CX-1, 1BF

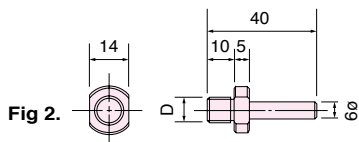

Parts No.	Size	Models
	D	
A-122693-02	W3/8-24	FA-2C-2, 3
A-122693-03	W3/8-16	FA-2CX-2, 3 Series

SPACER

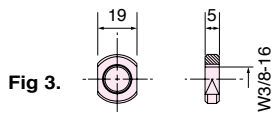

Part No.	Models
A-122308-01	FA-2C-3, 3BF, 2CX-3, 3BF

RUBBER BACKING PADS Fig 4.

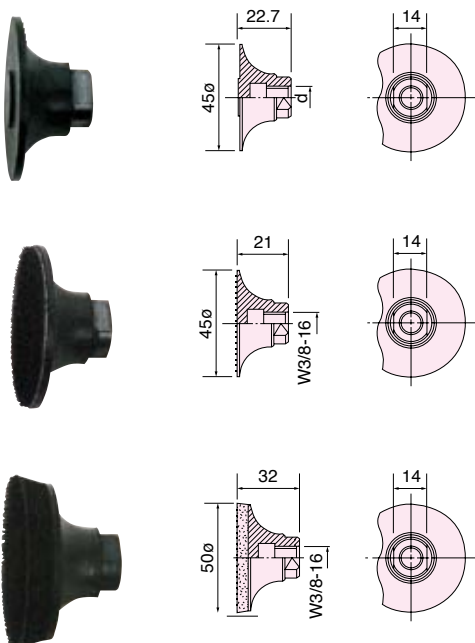

ADHESIVE TYPE

AC No.	Size
	d
RP-2-1	W3/8-24
RP-2-2	W3/8-16

VELCRO TYPE

AC No.
MP-2-1

VELCRO WITH SPONGE TYPE

AC No.
MP-2-1S

SANDING DISCS

Fig 5.

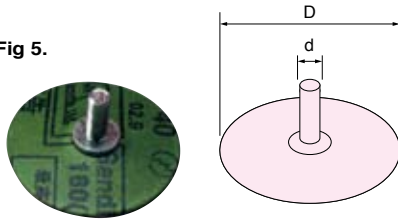

SHAFT TYPE

AC No.	Size		Grit #	Models
	D	d		
	mm	mm		
MD-1	50	1/4-28 UNF	40	FA-2C-1, 1BF FA-2CX-1, 1BF
MD-2			60	
MD-3			80	
MD-4			100	
MD-5			120	

*Minimum order required : 50pcs. / item

Fig 6.

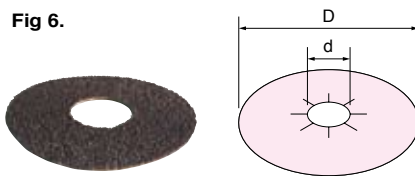

ADHESIVE TYPE

AC No.	Size		Grit #	Models
	D	d		
	mm	mm		
DP-2-1	50	16	40	FA-2C-2, 3 FA-2CX-2, 3 Series
DP-2-2			60	
DP-2-3			80	
DP-2-4			100	
DP-2-5			120	
DP-2-6			150	
DP-2-7			180	
DP-2-8			240	
DP-2-9			320	
DP-2-10			400	

*Minimum order required : 100pcs. / item

Fig 7.

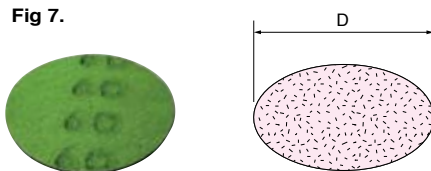

VELCRO TYPE

AC No.	Size	Grit #	Models
	D		
	mm		
MP-2-10	50	40	FA-2C-2, 3 FA-2CX-2, 3 Series
MP-2-2		60	
MP-2-3		80	
MP-2-4		100	
MP-2-5		120	
MP-2-6		150	
MP-2-7		240	
MP-2-8		320	

*Minimum order required : 100pcs. / item

CUP WHEEL

Fig 8.

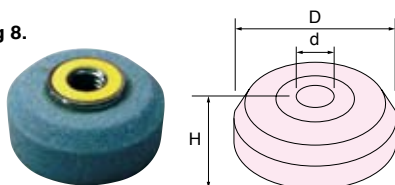

AC No.	Size			Grit #	Models
	D	H	d		
	mm	mm	mm		
MC-2-16	40	18	W3/8-16	60	FA-2C-2, 2BF, 2CX-3, 3BF

*Minimum order required : 10pcs. / item

RUBBER PAD AND WIRE BRUSH COMBINATION FOR ANGLE SANDERS

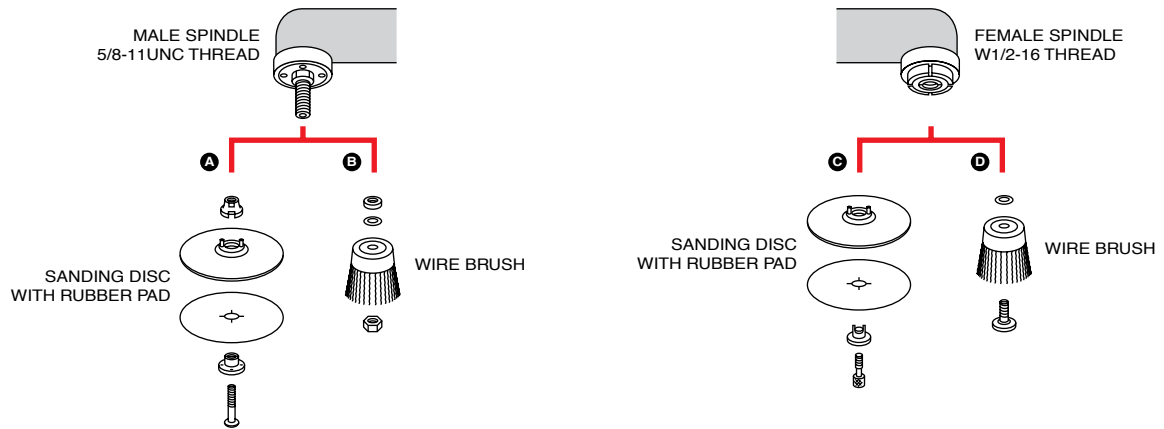

*Male Spindle 3/8-24UNF Thread type is applicable to **A** type

RUBBER BACKING PADS FOR ANGLE AND VERTICAL SANDERS

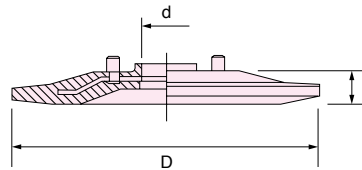

AC No.	Size						Pin Space		Maximum Rotational Frequency min ⁻¹	Models
	D		t		d					
	mm	in	mm	in	mm	in	mm	in		
RP-2-1	45	1 49/64	22.7	57/64	-	3/8-24UNF	with Attachments		15,000	FA-2C-1, 1BF, 2CX-1, 1BF *(A-122693-00) FA-2C-2, 2CX-2, 2C-3, 2CX-3 Series *(A-122693-02)
RP-2-2	45	1 49/64	22.7	57/64	-	W3/8-16	"		15,000	FA-2C-1, 1BF, 2CX-1, 1BF *(A-122693-01) FA-2C-2, 2CX-2, 2C-3, 2CX-3 Series *(A-122693-03)
RP-3-2	75	3	10.5	13/32	15.8	5/8	without Pin		13,500	FA-3CK-1
RP-4-3	100	4	12.0	15/32	15.8	5/8	34	1 11/32	13,500	FA-4C-1, 1F, 4CH-1, 1F
RP-4-5	100	4	17.0	43/64	22.2	7/8	46	1 13/16	10,000	FA-4CHK-3
RP-5-3	125	5	17.0	43/64	22.2	7/8	44	1 47/64	8,500	FA-150K-2, 3
RP-5-5	125	5	17.0	43/64	22.2	7/8	46	1 13/16	8,500	FA-4CHK-3, 5C-5, 150KG-7, 5E-7 Series
RP-5-6	125	5	14.0	35/64	22.2	7/8	46	1 13/16	8,500	FA-5E-4 Series
RP-7	180	7	15.0	19/32	22.2	7/8	46	1 13/16	7,000	FA-150KG-7, 5C-5, 6C-9, 10, FA-5E-6 Series, 5E-7V, 7E-1, 5 Series, FV-7-1M, 2M
RP-9-1	230	9	15.0	19/32	22.2	7/8	46	1 13/16	5,900	FA-9C-2, 2M, 4, 4M, FV-9BH-1M

*Marked * are attachment number.

DISC BACKING PADS FOR FG-5PX-1

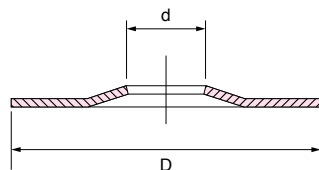

AC No.	Size				Model
	D		d		
	mm	in	mm	in	
FP-3-1	75	3	22.2	7/8	FG-5PX-1
FP-5-1	125	5	22.2	7/8	

Accessories

SANDING DISCS FOR ANGLE AND VERTICAL SANDERS

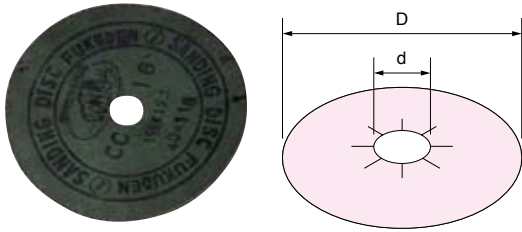

AC No.	Size				Grain #	Models
	D		d			
	mm	in	mm	in		
DP-5	125	5	22.2	7/8	14~60	FG-5PX-1
DP-6	150	6	22.2	7/8	14~60	FA-4CHK-3, 3F FA-150K-2, 3
DP-7	180	7	22.2	7/8	14~60	FA-6C-9, 9M FA-7E-1, 5 Series, 150KG-7 FV-7-1M, 2M
DP-9	230	9	22.2	7/8	14~50	FA-9C-2

*Minimum order required :100pcs. / item

BEVEL WIRE BRUSHES

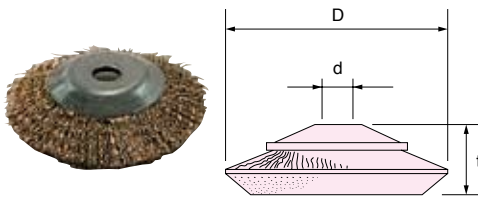

AC No.	Size			Maximum Rotational Frequency	Models
	D	t	d		
	mm	mm	mm		
195	125	35	16	8,400	FA-150K-2, 3, 4CHK-3, 3F
195S	125	35	16	8,400	

*S - Stainless Steel

*Minimum order required :10pcs. / item.

CUP WIRE BRUSHES

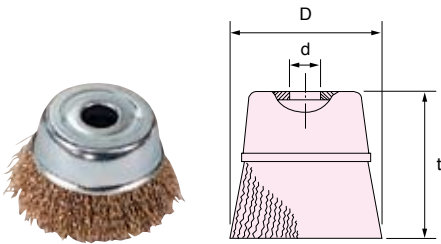

AC No.	Size			Maximum Rotational Frequency	Models
	D	t	d		
	mm	mm	mm		
192	75	47	16	8,400	FA-150K-2, 3, 4CHK-3, 3F
193	100	55	16	8,400	
192S	75	47	16	7,000	FA-6C-9, 10, 9M, 5C-5
193S	100	55	16	7,000	FA-6C-9, 10, 9M, 5C-5
194	120	65	16	6,000	FA-150KG-7

*S - Stainless Steel

*Minimum order required :10pcs. / item.

CENTER DEPRESSED WHEELS FOR ANGLE AND VERTICAL GRINDERS

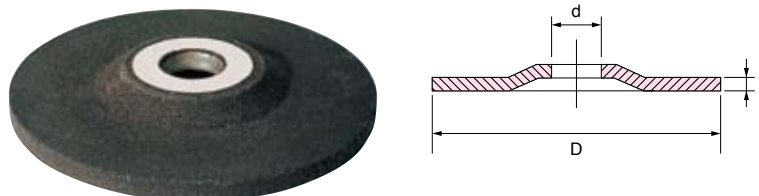

AC No.	Size						Material	Maximum Rotational Frequency	Models
	D		t		d				
	mm	in	mm	in	mm	in			
161	50	2	4	5/32	9.53	3/8	15,000	FA-2C-1, 1BF, 2CX-1, 1BF	
161-1S	50	2	2	5/64	9.53	3/8			
162	75	3	4	5/32	9.53	3/8	15,000	FA-3C-1, 1F, 3CX-1, 1F	
163	100	4	6	1/4	16.00	5/8	13,500	FA-3C-2, 6, 3CX-2, 6 Series, 4C-1, 1F, 4CH-1, 1F, 5E-3 Series	
169	125	5	6	1/4	22.00	7/8	12,000	FA-5E-1, 2, 13 Series	
165	180	7	6	1/4	22.00	7/8	8,400	FA-150KG-5, 6C-1, 1M, 6, 6M, 8, 8M, 9, 9M, 12, 12M FA-7E-1, 2, 3, 5, 6, 8 Series, FV-7-1M, 2M, 4M	
168	230	9	6	1/4	22.00	7/8	5,900	FA-9C-2, 2M, 4, 4M, FV-9BH-1M	

*Minimum order required : 25pcs. / item. (162 = Minimum order required : 500pcs. / item, 168 = Minimum order required :10pcs. / item.)

Drills / Tappers

[Drills]

DRILL SIZE, CUTTING SPEED AND MATERIAL	70
FEATURES	71
DRILLS	72
BABY ANGLE DRILLS	74
CORNER DRILLS	74

[Accessories-Drills]	76
----------------------------	----

[Tappers]

FEATURES	77
TAPPERS	78

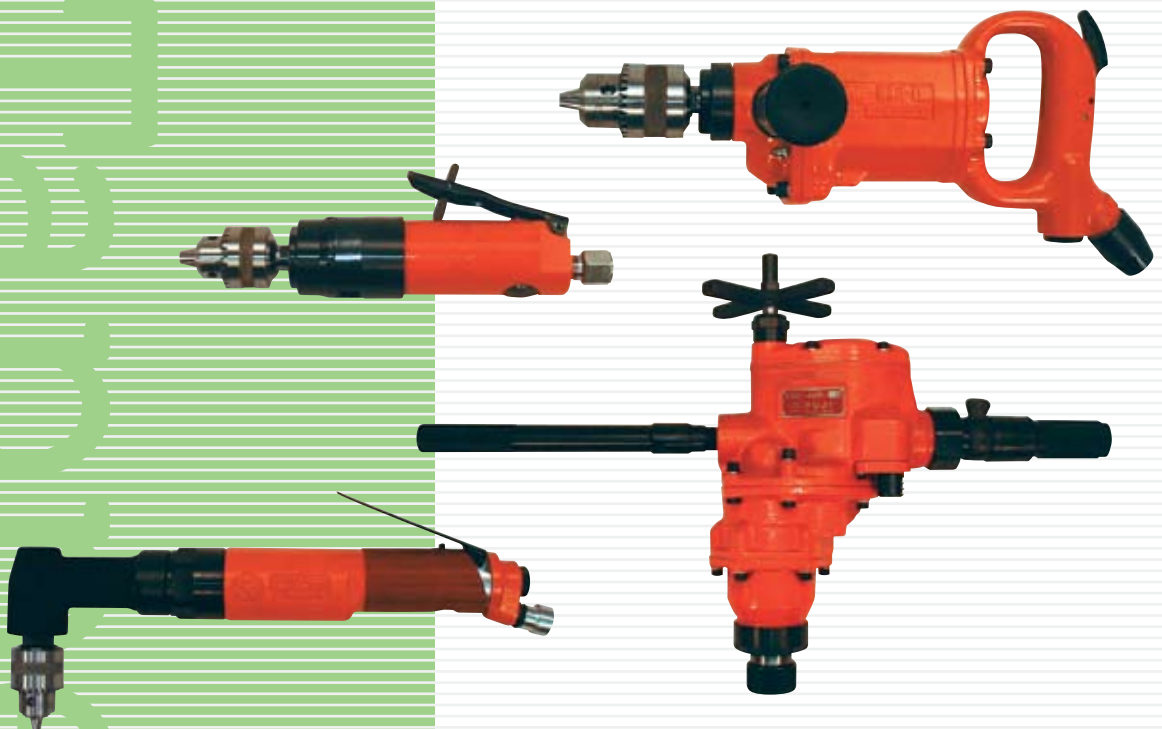

DRILL SIZE, CUTTING SPEED AND MATERIAL

When selecting a suitable model of drill for your application, it should be chosen on the basis of drill bit size and suitable cutting speed for the material to be drilled. The table below shows the recommended drill bit sizes for different speeds when drilling some common materials. The figures in the table are based on drill speeds at normal pressure and the minimum torque in conjunction with drill breakthrough. The table only shows which drill bit sizes give the cutting speeds within the ranges stated. Note that it is quite possible to drill with smaller diameter drill bits, i.e. at lower cutting speeds. Longer drill bits than those indicated may also be used for occasional drilling work. However, in the case of drill bit sizes larger than the standard chuck capacity of the machine, the torque may be insufficient for the high cutting forces occurring in conjunction with drill breakthrough.

In order to obtain a sufficient cutting force when applying feed pressure by hand, pre-drilling is recommended for drill bit sizes above 8 mm when drilling in mild steel, soft cast iron, malleable iron as well as for holes larger than 6 mm in forged steel and stainless steel.

Suggested Rotational Frequency (min⁻¹) for Proper Drilling

Material	Stainless Steel	Forged Steel	Mild Steel	Soft Cast Iron	Malleable Iron	Brass or Bronze	Aluminum	Magnesium	Plastic	Wood	Titanium
Cutting speed (m/min) Drill bit size	9-12	12-15	24-33	30-45	24-27	60-90	60-90	75-120	30-45	90-120	15-18
3mm	1100	1400	3000	4000	2700	8000	8000	10400	4000	11000	1750
4mm	840	1100	2200	3000	2000	6000	6000	7800	3000	8400	1300
5mm	660	860	1800	2400	1600	4800	4800	6200	2400	6700	1050
6mm	550	700	1500	2000	1350	4000	4000	5200	2000	5600	880
8mm	420	540	1100	1500	1000	3000	3000	3900	1500	4200	660
10mm	330	430	900	1200	800	2400	2400	3100	1200	3300	630
12mm	280	350	750	1000	700	2000	2000	2600	1000	2800	440
13mm	260	330	700	920	630	1800	1800	2400	920	2550	400
14mm	240	300	640	850	580	1700	1700	2200	850	2400	370
16mm	210	270	560	750	500	1500	1500	1950	750	2100	330
19mm	180	230	480	630	430	1250	1250	1600	630	1800	280
22mm	150	200	410	540	370	1100	1100	1400	540	1500	240
23mm	140	190	390	520	350	1000	1000	1350	520	1450	230
25mm	130	170	360	480	320	960	960	1250	480	1330	210
28mm	120	150	320	420	290	850	850	1100	420	1200	190
32mm	100	130	280	380	250	750	750	980	380	1050	160
44mm	75	100	210	270	180	550	550	700	270	750	120
50mm	65	85	180	240	160	480	480	620	240	670	110
75mm	44	57	120	160	110	320	320	420	160	450	70
100mm	33	43	90	120	80	240	240	310	120	330	55

FEATURES

1 REVERSIBLE DRILLS

Fuji offer some reversible drills. The reverse action is selected by simply turning the reverse lever.

FRD-20R~100R, FCD-23R~100R, F-22RCR, 32RCR

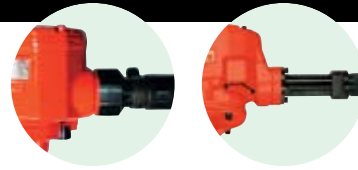

2 TWO-STAGE THROTTLE ACTUATION

This mechanism allows slow start smooth operation to full speed allowing the drill bit to be centralised prior to drilling at full speed.

FRD-5P, 8PX, 12Z~16Z



3 SWIVEL TYPE EXHAUST COVER

The exhaust cover can be rotated to enable the operator to choose a convenient direction of the exhaust air.

FRD-20R~50R, FCD-23R~100R



4 REAR EXHAUST WITH BUILT-IN MUFFLER

The noise level is minimised via the muffler built into the exhaust cover.

FRD-5P, 6PX, 8PX, FCD-6X, 10X



5 LOCKING HANDLE

The locking handle is designed to reduce the risk of inadvertent starting of the drill. The handle reverts automatically to the locked position when released.

A. ROLL TYPE

F-14CN, 22RCN, 32RCN, 32RCNS

B. LEVER TYPE

FCD-6X-1F, 2F, 10X-1F, 6B-1F

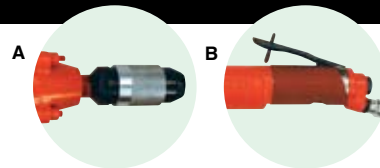

6 PLASTIC COVER

The plastic cover softens the effect of vibration during the drilling application and creates a "warm to touch" feel to improve operator comfort.

FCD-10X, 6EX



7 DEAD HANDLE

The dead handle helps to soften the breakthrough reaction force experienced when drilling "through holes".

FRD-6S-7, 6PX-7, 8PX-2, 3, 12Z~16Z



8 SELF-RETURN ROLL HANDLE

When the operator releases the handle, it automatically returns to the "OFF" position and the air supply is switched off. When ordering, add "S" to the end of the model name.

FRD-20R~100R, FCD-23R~100R



9 SWIVEL TYPE AIR EXHAUST HOSE JOINT (OPTION)

Connecting an air exhaust hose, with the optional swivel type air exhaust hose joint, provides improved operator comfort by directing the exhaust air away and reducing the noise level.

FRD-20R~50R, FCD-23R~100R



Drills

DRILLS

Fuji Drills are light weight with a sturdy construction. Their practical design represents Fuji's latest developments in drills technology. Fuji offers a complete line of drills with a drilling capacity range from 2mm to 100mm.

Straight / Side Exhaust Type

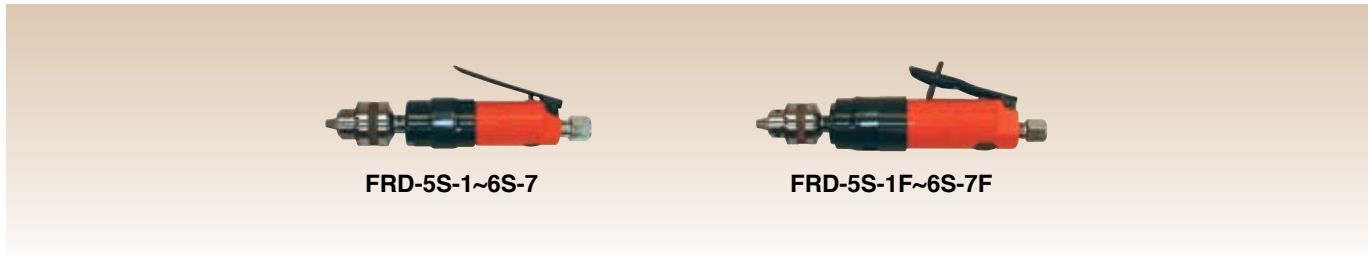

Model		Drilling Capacity		Stall Torque			Rotational Frequency	Type and Size of Spindle		Chuck Capacity (mm)		Side to Center		Overall Length		Mass		Max. Air Consumption	
Thread Type	Taper Type	mm	in	N·m	kgf·m	ft·lb	min ⁻¹	Thread	Taper	Thread	Taper	mm	in	mm	in	kg	lb	m ³ /min	ft ³ /min
FRD-5S-1(F)	—	5	3/16	2.0	0.20	1.4	3,200	3/8-24	—	6.5	—	18.5	47/64	175	6 57/64	0.6	1.3	0.60	21.2
—	FRD-5S-2T(F)	2	5/64	0.3	0.03	0.2	24,000	—	J.T.#D	—	5.0	18.5	47/64	164	6 15/32	0.6	1.3	0.60	21.2
FRD-6S-2(F)	—	5	3/16	2.5	0.25	1.8	4,300	3/8-24	—	6.5	—	21.0	53/64	209	8 15/64	0.9	1.9	0.68	24.0
FRD-6S-3(F)	—	8	5/16	2.9	0.30	2.1	2,800	3/8-24	—	8.0	—	21.0	53/64	212	8 23/64	1.0	2.2	0.68	24.0
FRD-6S-5(F)	—	10	7/16	6.9	0.70	5.0	1,300	3/8-24	—	10.0	—	23.0	29/32	233	9 3/16	1.0	2.2	0.68	24.0
•FRD-6S-7(F)	—	13	1/2	15.7	1.60	11.5	600	1/2-20	—	13.0	—	21.0	53/64	261	10 9/32	1.5	3.3	0.68	24.0

*FRD-5 series: 1/4" Air Inlet, 1/4"(6.35mm) Air Hose. All other models: 1/4" Air Inlet, 3/8"(9.5mm) Air Hose.

*Marked • are furnished with Dead Handle.

*The models marked (F) are Locking Lever handle type (FRD-5S-1F, 2TF, 6S-2F, 3F, 5F, 7F).

Pistol / Rear Exhaust Type



Model		Drilling Capacity		Stall Torque			Rotational Frequency	Type and Size of Spindle		Chuck Capacity (mm)		Side to Center		Overall Length		Mass		Max. Air Consumption	
Thread Type	Taper Type	mm	in	N·m	kgf·m	ft·lb	min ⁻¹	Thread	Taper	Thread	Taper	mm	in	mm	in	kg	lb	m ³ /min	ft ³ /min
FRD-5P-1	—	5	3/16	2.0	0.20	1.4	3,200	3/8-24	—	6.5	—	18.0	45/64	155	6 7/64	0.6	1.3	0.40	14.1
FRD-6PX-2	—	5	3/16	2.5	0.25	1.8	4,300	3/8-24	—	6.5	—	21.0	53/64	167	6 37/64	1.1	2.4	0.55	19.4
FRD-6PX-3	—	8	5/16	3.0	0.30	2.1	2,800	3/8-24	—	8.0	—	21.0	53/64	171	6 47/64	1.1	2.4	0.55	19.4
FRD-6PX-5	—	10	7/16	6.9	0.70	5.0	1,300	3/8-24	—	10.0	—	22.5	57/64	187	7 3/8	1.3	2.8	0.55	19.4
•FRD-6PX-7	—	13	1/2	15.7	1.60	11.5	600	1/2-20	—	13.0	—	22.5	57/64	222	8 3/4	1.7	3.7	0.55	19.4
FRD-8PX-1	—	8	5/16	5.9	0.60	4.3	2,600	3/8-24	—	8.0	—	25.0	63/64	187	7 3/8	1.5	3.3	0.76	26.8
•FRD-8PX-2	—	10	7/16	11.8	1.20	8.6	1,300	3/8-24	—	10.0	—	26.5	1 3/64	210	8 9/32	1.9	4.2	0.76	26.8
•FRD-8PX-3	—	13	1/2	16.7	1.70	12.3	900	1/2-20	—	13.0	—	25.5	1	240	9 29/64	2.5	5.5	0.76	26.8

*FRD-5 series: 1/4" Air Inlet, 1/4"(6.35mm) Air Hose. All other models: 1/4" Air Inlet, 3/8"(9.5mm) Air Hose.

*Marked • are furnished with Dead Handle.

Drill Chucks



No.	Models	Type and Size of Spindle	Chuck Capacity
DCK-5J	FRD-5S-2T, 2TF	J.T.#D(Taper)	5mm
DCK-6.5	FRD-5S-1, 1F, 6S-2, 2F, 5P-1, 6PX-2	3/8-24(Thread)	6.5mm
DCK-8	FRD-6S-3, 3F, 6PX-3, 8PX-1	3/8-24(Thread)	8mm
DCK-10	FRD-6S-5, 5F, 6PX-5, 8PX-2	3/8-24(Thread)	10mm
DCK-13	FRD-6S-7, 7F, 6PX-7, 8PX-3, 12Z-1, 1C	1/2-20(Thread)	13mm
DCK-16	FRD-16Z-1, 1C	5/8-16(Thread)	16mm

Grip Handle Medium Size Drills



FRD-12Z-1, 16Z-1
(Outside Lever)



FRD-12Z-1C, 16Z-1C
(Inside Lever)

Model		Drilling Capacity (Guidance)		Stall Torque			Rotational Frequency	Type and Size of Spindle		Chuck Capacity	Side to Center		Overall Length		Mass		Max. Air Consumption	
Outside Lever	Inside Lever	mm	in	N·m	kgf·m	ft·lb	min ⁻¹	Thread	Taper	mm	mm	in	mm	in	kg	lb	m ³ /min	ft ³ /min
FRD-12Z-1	FRD-12Z-1C	12	1/2	22.0	2.2	15.9	1,200	1/2-20	-	13	34	1 11/32	324	12 3/4	3.3	7.3	1.20	42.4
FRD-16Z-1	FRD-16Z-1C	16	5/8	34.3	3.5	25.3	800	5/8-16	-	16	34	1 11/32	364	14 21/64	3.7	8.1	1.20	42.4

*3/8" Air Inlet Thread Size. 12.7mm(1/2") Air Hose Size. All models can be used for reaming work. FRD-12Z series 8mm capacity, and FRD-16Z series 13mm capacity.

Heavy-Duty Rotary Drills



FRD-20R~32R

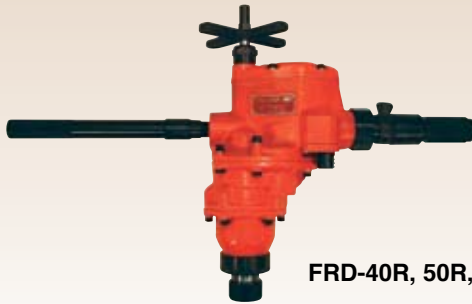

FRD-40R, 50R, 65R

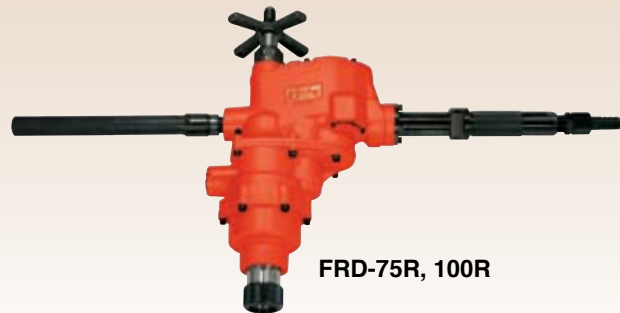

FRD-75R, 100R

Model		Capacity (Guidance)				Stall Torque			Rotational Frequency	Socket	Feed Length		Overall Length		Mass		Max. Air Consumption	
Roll Type	Self-return Type	mm	in	mm	in	N·m	kgf·m	ft·lb	min ⁻¹	M.T.#	mm	in	mm	in	kg	lb	m ³ /min	ft ³ /min
FRD-20R-21	FRD-20R-21S	19	3/4	16	5/8	63.7	6.5	47.0	600	2	67	2 41/64	282	11 7/64	7.0	15.4	1.20	42.4
FRD-20R-22	FRD-20R-22S	19	3/4	16	5/8	63.7	6.5	47.0	600	3	67	2 41/64	307	12 3/32	7.0	15.4	1.20	42.4
FRD-23R-21	FRD-23R-21S	22	7/8	19	3/4	78.4	8.0	57.8	480	2	67	2 41/64	282	11 7/64	7.3	16.0	1.20	42.4
FRD-23R-22	FRD-23R-22S	22	7/8	19	3/4	78.4	8.0	57.8	480	3	67	2 41/64	307	12 3/32	7.4	16.3	1.20	42.4
FRD-25R-11	FRD-25R-11S	25	1	22	7/8	147.0	15.0	108.4	530	3	96	3 25/32	353	13 29/32	14.0	30.8	3.20	113.0
FRD-28R-11	FRD-28R-11S	28	1 1/8	25	1	177.0	18.0	130.1	430	3	96	3 25/32	353	13 29/32	14.0	30.8	3.20	113.0
FRD-32R-11	FRD-32R-11S	32	1 1/4	25	1	196.0	20.0	144.6	380	3	96	3 25/32	353	13 29/32	14.5	31.9	3.20	113.0
FRD-32R-12	FRD-32R-12S	32	1 1/4	25	1	196.0	20.0	144.6	380	4	96	3 25/32	353	13 29/32	14.5	31.9	3.20	113.0
FRD-40R-11	FRD-40R-11S	44	1 47/64	32	1 1/4	304.0	31.0	224.2	220	4	93	3 43/64	446	17 9/16	18.7	41.1	3.20	113.0
FRD-50R-11	FRD-50R-11S	50	2	50	2	431.0	44.0	318.1	150	4	93	3 43/64	446	17 9/16	18.7	41.1	3.20	113.0
FRD-65R-1	FRD-65R-1S	65	2 9/16	65	2 9/16	608.0	62.0	448.4	190	5	125	4 59/64	487	19 11/64	32.0	70.4	5.50	194.2
FRD-75R-1	FRD-75R-1S	75	3	75	3	1156.0	118.0	855.0	85	5	128	5 3/64	600	23 5/8	43.0	94.6	5.50	194.2
FRD-100R-1	FRD-100R-1S	100	4	100	4	1823.0	186.0	1344.8	55	5	128	5 3/64	600	23 5/8	43.0	94.6	5.50	194.2

*Air Hose Size: FRD-20R~23R: 1/2", FRD-25R~50R: 3/4", FRD-65R~100R: 1".

*Air Inlet Thread Size: FRD-65R~100R: 1". All other models: 1/2".

Baby Angle Drills/Corner Drills

BABY ANGLE DRILLS

Fuji Baby Angle Drills are equipped with a compact head (low height and side-to-center head dimensions) to allow these tools to be used in confined areas. Ball and needle bearings used throughout angle heads provide long service life and less spindle run-out.

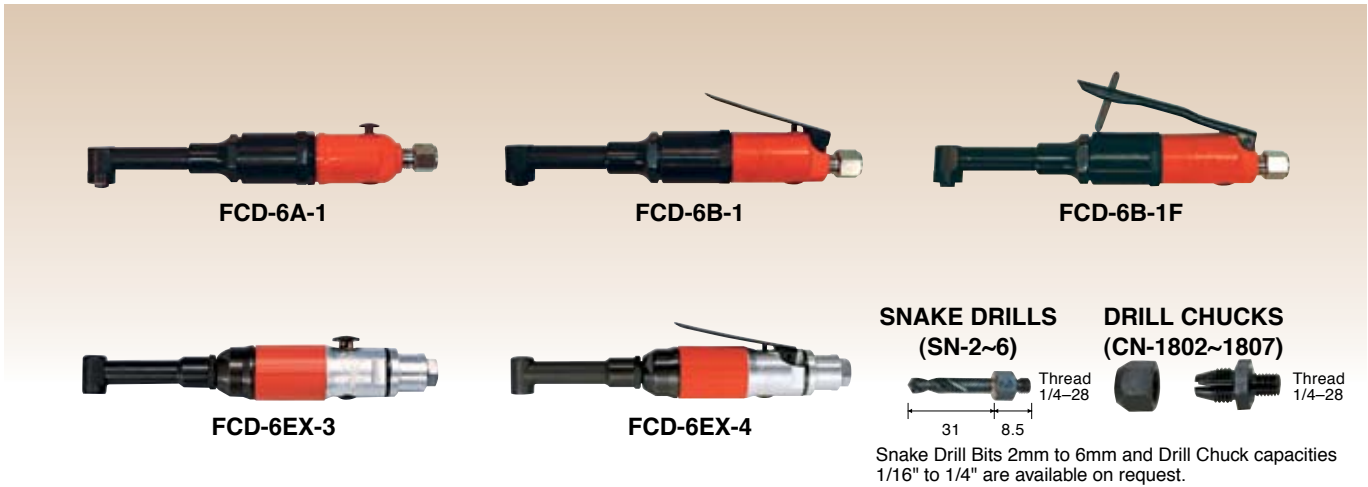

Model	Drilling Capacity (Guidance)		Stall Torque			Rotational Frequency	Spindle Thread		Side to Center		Overall Length		Mass		Max. Air Consumption		Air Inlet Thread Size	Air Hose Size	
	mm	in	N·m	kgf·m	ft·lb	min ⁻¹	in	mm	in	mm	in	kg	lb	m ³ /min	ft ³ /min	PT or NPT	mm	in	
Front Exhaust Type																			
FCD-6A-1	6	1/4	2.5	0.25	1.8	2,500	1/4-28UNF	9.5	3/8	223	8 49/64	0.60	1.3	0.56	19.8	1/4	6.3	1/4	
FCD-6B-1	6	1/4	2.5	0.25	1.8	2,500	1/4-28UNF	9.5	3/8	222	8 47/64	0.60	1.3	0.56	19.8	1/4	6.3	1/4	
FCD-6B-1F	6	1/4	2.5	0.25	1.8	2,500	1/4-28UNF	9.5	3/8	222	8 47/64	0.60	1.3	0.56	19.8	1/4	6.3	1/4	
Rear Exhaust Type																			
FCD-6EX-3	6	1/4	2.9	0.30	2.2	3,500	1/4-28UNF	8.5	11/32	246	9 11/16	0.69	1.5	0.76	26.9	1/4	6.3	1/4	
FCD-6EX-4	6	1/4	2.9	0.30	2.2	3,500	1/4-28UNF	8.5	11/32	246	9 11/16	0.69	1.5	0.76	26.9	1/4	6.3	1/4	

CORNER DRILLS

Fuji utilizes their power transmission knowledge in their line of corner drills. In addition to their power, these drills are designed to work well in confined spaces.

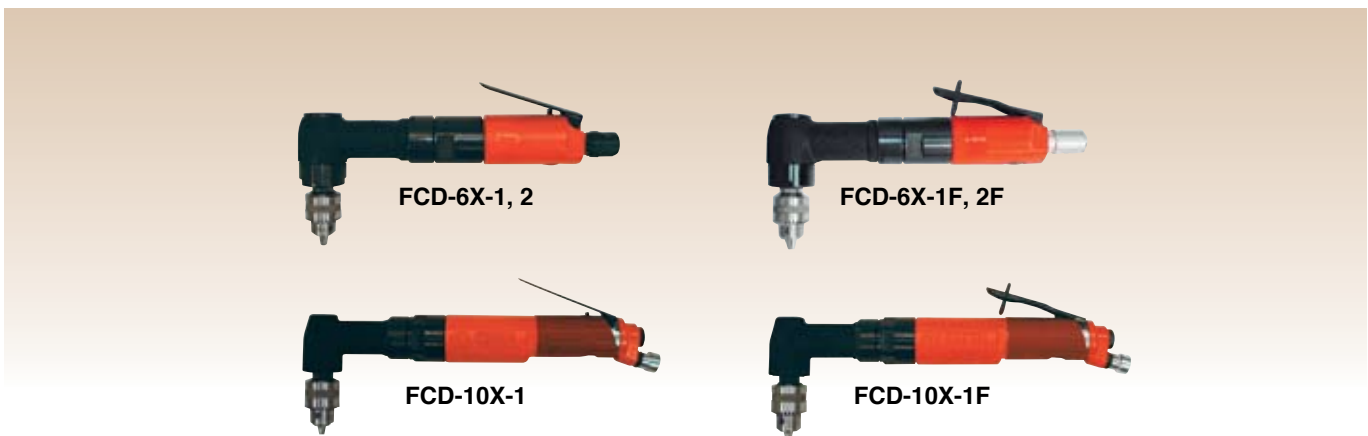

Model		Drilling Capacity (Guidance)		Stall Torque			Rotational Frequency	Spindle Thread Size	Chuck Capacity	Side to Center			Overall Length		Mass		Max. Air Consumption		Air Hose Size	
Push Lever	Locking Lever	mm	in	N·m	kgf·m	ft·lb	min ⁻¹	in	mm	mm	in	mm	in	kg	lb	m ³ /min	ft ³ /min	mm	in	
FCD-6X-1	FCD-6X-1F	6	1/4	4.9	0.50	3.6	2,500	3/8-24UNF	6.5	21	53/64	267	10 33/64	1.7	3.7	0.68	24.0	9.5	3/8	
FCD-6X-2	FCD-6X-2F	8	5/16	7.8	0.80	5.7	1,500	3/8-24UNF	8.0	21	53/64	281	11 1/16	1.9	4.1	0.68	24.0	9.5	3/8	
FCD-10X-1	FCD-10X-1F	10	7/16	11.8	1.20	8.6	1,200	1/2-20UNF	10.0	21	53/64	377	14 27/32	2.2	4.8	0.50	17.6	9.5	3/8	

*1/4" Air Inlet Thread Size, All models are Rear Exhaust types.

Heavy-Duty Corner Drills (Non-Reversible)

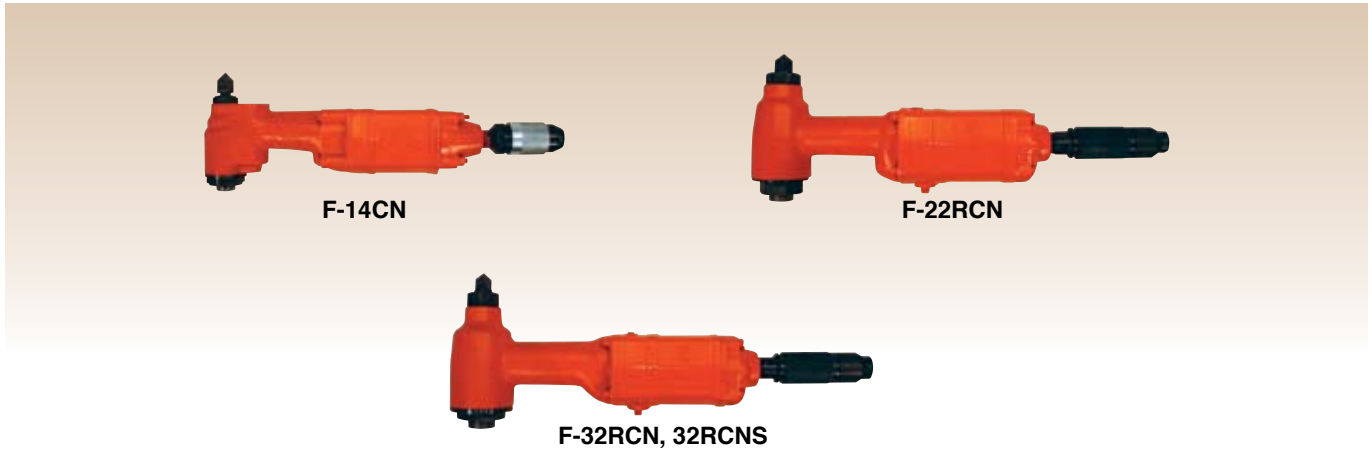

Model		Capacity (Guidance)				Stall Torque			Rotational Frequency	Socket	Side to Center		Feed Length		Overall Length		Mass		Max. Air Consumption	
		Drilling		Reaming Tapping																
Roll Type	Self-return Type	mm	in	mm	in	N·m	kgf·m	ft·lb	min ⁻¹	M.T.#	mm	in	mm	in	mm	in	kg	lb	m ³ /min	ft ³ /min
F-14CN	F-14CN-1S	14	9/16	9.5	3/8	31.4	3.2	23.1	1,000	1	24	15/16	38	1 1/2	410	16 9/64	4.6	10.1	1.25	44.1
F-14CN-2	F-14CN-2S	14	9/16	9.5	3/8	31.4	3.2	23.1	1,000	2	24	15/16	38	1 1/2	410	16 9/64	4.6	10.1	1.25	44.1
F-22RCN	F-22RCN-1S	22	7/8	19.0	3/4	108.0	11.0	79.5	450	2	35	1 3/8	60	2 3/8	493	19 13/32	8.5	18.7	1.50	53.0
F-32RCN	F-32RCN-1S	32	1 1/4	25.0	1	127.0	13.0	94.0	400	3	40	1 37/64	60	2 3/8	523	20 19/32	9.7	21.3	1.50	53.0
F-32RCNS	F-32RCNS-1S	32	1 1/4	25.0	1	127.0	13.0	94.0	400	3	40	1 37/64	25	1	529	20 53/64	8.8	19.3	1.50	53.0

*12.7mm (1/2") Air Hose Size.

*Air Inlet Size: F-14CN series: 3/8", All others: 1/2".

Heavy-Duty Corner Drills (Reversible)

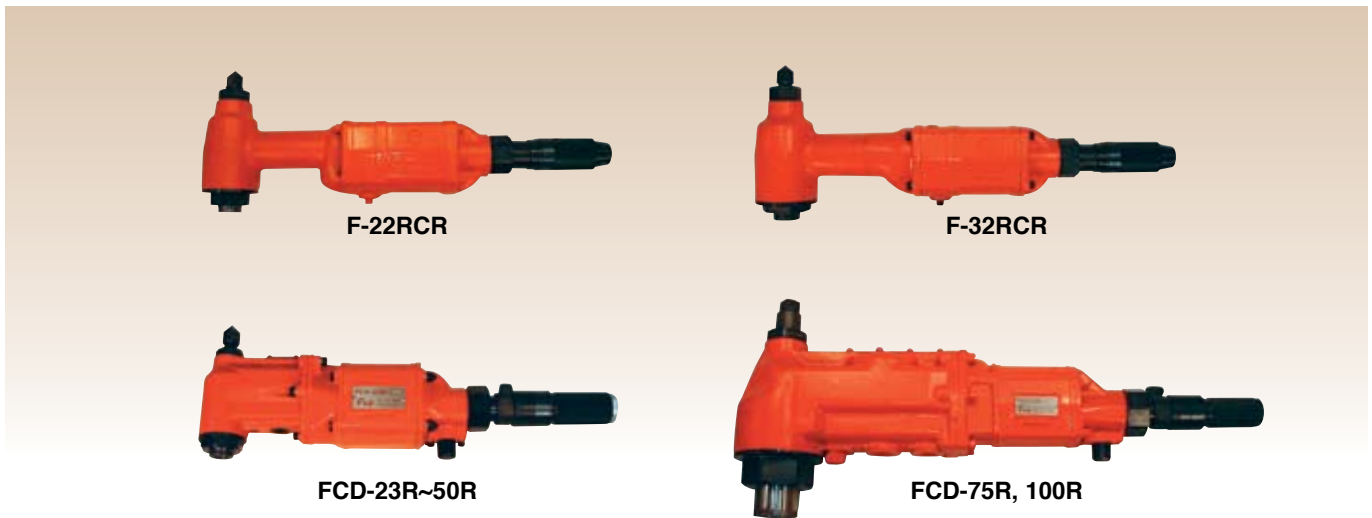

Model		Capacity (Guidance)				Stall Torque			Rotational Frequency	Socket	Side to Center		Feed Length		Overall Length		Mass		Max. Air Consumption	
		Drilling		Reaming Tapping																
Roll Type	Self-return Type	mm	in	mm	in	N·m	kgf·m	ft·lb	min ⁻¹	M.T.#	mm	in	mm	in	mm	in	kg	lb	m ³ /min	ft ³ /min
F-22RCR	F-22RCR-1S	22	7/8	19.0	3/4	93.2	9.5	68.7	400	2	35	1 3/8	60	2 3/8	505	19 7/8	8.5	18.7	1.50	53.0
F-32RCR	F-32RCR-1S	32	1 1/4	25.0	1	113.0	11.5	83.1	315	3	40	1 37/64	60	2 3/8	538	21 3/16	10.0	22.0	1.50	53.0
FCD-23R-11	FCD-23R-11S	22	7/8	19.0	3/4	80.4	8.2	59.3	430	2	27	1 1/16	35	1 3/8	472	18 37/64	7.0	15.4	1.50	53.0
FCD-23R-12	FCD-23R-12S	22	7/8	19.0	3/4	80.4	8.2	59.3	430	3	27	1 1/16	35	1 3/8	472	18 37/64	7.1	15.6	1.50	53.0
FCD-32R-11	FCD-32R-11S	32	1 1/4	32.0	1 1/4	177.0	18.0	130.1	350	3	35	1 3/8	53	2 1/8	578	22 3/4	13.5	29.7	1.80	63.5
FCD-50R-11	FCD-50R-11S	50	2	50.0	2	392.0	40.0	289.3	140	4	41	1 5/8	58	2 5/16	595	23 27/64	16.0	35.2	2.25	79.4
FCD-75R-11	FCD-75R-11S	75	3	75.0	3	834.0	85.0	614.8	85	5	49	1 15/16	57	2 1/4	651	25 5/8	20.5	45.1	2.50	88.3
FCD-100R-11	FCD-100R-11S	100	4	100.0	4	1370.0	140.0	1012.6	40	5	62	2 7/16	105	4 1/8	730	28 3/4	29.3	64.4	2.25	79.4

*Air Hose Size: FCD-23 series and F-22, -32series 12.7mm(1/2"), All others: 19mm (3/4") .

*Air Inlet Thread Size: 1/2".

Accessories

COLLET CHUCKS, SNAKE DRILLS, ATTACHMENT AND PADS FOR FCD-6A, 6B AND 6EX

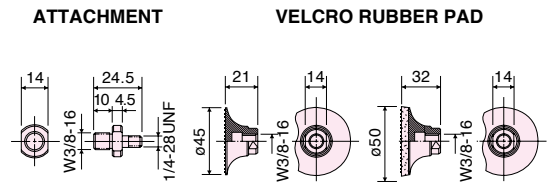
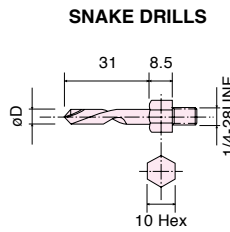
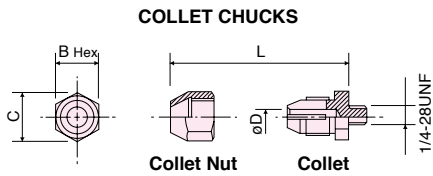

AC No.	Part No.		Size				
	Collet Nut	Collet	D	B(Hex)	C	L	
CN-1801	D-021343-00	D-021342-02	—	1/16	12	13.8	15
CN-1802	D-021343-00	D-021342-00	3	—	12	13.8	15
CN-1803	D-021343-00	D-021342-01	3.2	—	12	13.8	15
CN-1804	D-023343-01	D-023342-01	4	—	14	16.2	21
CN-1805	D-023343-01	D-023342-03	—	3/16	14	16.2	21
CN-1806	D-023343-01	D-023342-02	5	—	14	16.2	21
CN-1807	D-023343-00	D-023342-04	6	—	17	19.6	23
CN-1808	D-023343-00	D-023342-00	—	1/4	17	19.6	23

AC No.	Size
	D
SN-2	2
SN-3	3
SN-4	4
SN-5	5
SN-6	6

(with SPONGE)		
Part No.	Part No.	Part No.
A-179693-00	MP-2-1	MP-2-1S

VELCRO SANDING PAPERS

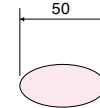

AC No.	Grit #
MP-2-10	40
MP-2-2	60
MP-2-3	80
MP-2-4	100
MP-2-5	120
MP-2-6	150
MP-2-7	240
MP-2-8	320

*Minimum order required :100pieces / item

STIRRING PROPELLERS

AC No. : AT-P01
For use with 10mm Drill Chuck

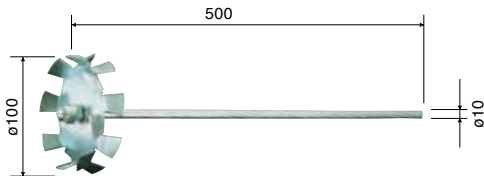

AC No. : AT-P02
For use with 13mm Drill Chuck

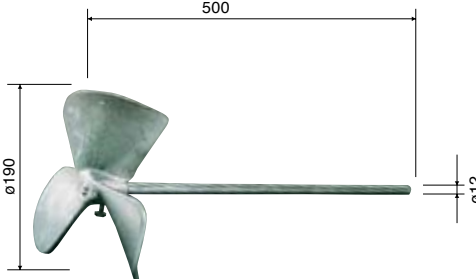

ADAPTERS TO CONNECT PROPELLERS TO DRILLS

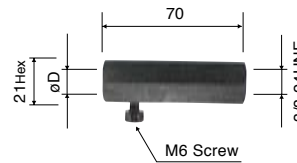

Part No.	Size	Stirring Propellers	models
	D		
M-002693-01	10	AT-P01	FRD-5S, 6S-2~5
M-002693-00	12	AT-P02	5P, 6PX-2~5 8PX-1, 2

*These adapters are designed to connect propellers directly to drills.

DEAD HANDLE FOR FRD-12Z, 16Z

PART No. : A-192014-00

This dead handle softens vibration and eases operator's fatigue much more than the ordinary dead handle.

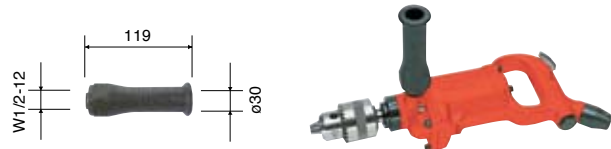

APPLICATION EXAMPLES

Stirring propellers attached to FRD series drills



SOFT JACKETS

- Soften vibration and Chill-touch
- Protect work piece and tool
- Improve fitness



AC No.	Applicable Dia.	Thickness x Length
	mm	
SO-25	22 – 28	2 x 120
SO-30	26 – 33	
SO-35	34 – 42	
SO-55	56 – 70	

FEATURES

1 REVERSING

A. Twin lever type-one lever for forward rotation (with throttle actuation) and one lever for reverse rotation (with throttle actuation).

FT-6BX

B. See-saw type lever for throttle actuation and reversing.

FT-8PX

C. Push Pull type-forward rotation when the tool is pushed into the work-piece, reverse rotation when the tool is pulled away from the work-piece.

FT-6P, 13Z

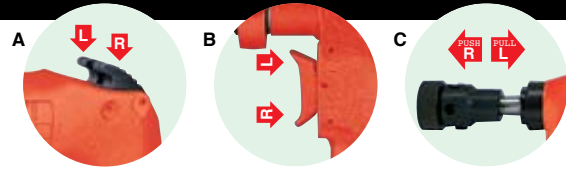

2 TWO-STAGE THROTTLING

This mechanism allows a "slow start" to ensure tap is correctly aligned prior to actuating "full speed".

FT-6P, 8PX, 13Z



3 AIR REGULATOR

A 4 click stop regulator is built in and the operator can regulate air supply for torque adjustment.

FT-6P



4 DEAD HANDLE

The dead handle is used to reduce the effect of "snatching" when tapping a through hole. It is also used when tapping "high torque" threads.

FT-8PX, 13Z



5 REAR EXHAUST WITH AIR EXHAUST HOSE

Connecting an air exhaust hose, provides improved operator comfort by directing the exhaust air away and reducing the noise level.

FT-6BX



6 REAR EXHAUST WITH BUILT-IN MUFFLER

The noise level is minimised via the muffler built into the exhaust cover.

FT-8PX



7 UNIVERSAL TAPPING CHUCK

The universal tapping chuck provides optimal grip of the tap during the tapping operation.

FT-6BX-1T, 8PX-1, 13Z-1



8 DRILL CHUCK

A drill chuck can also be used for tapping where appropriate.

FT-6P, 6BX-1(D Type)



TAPPERS

Easy to use throttle and reversing trigger combined with a universal tapping chuck provide a smooth tapping operation. Fuji Tappers are available in tapping capacities from 6mm to 13mm.

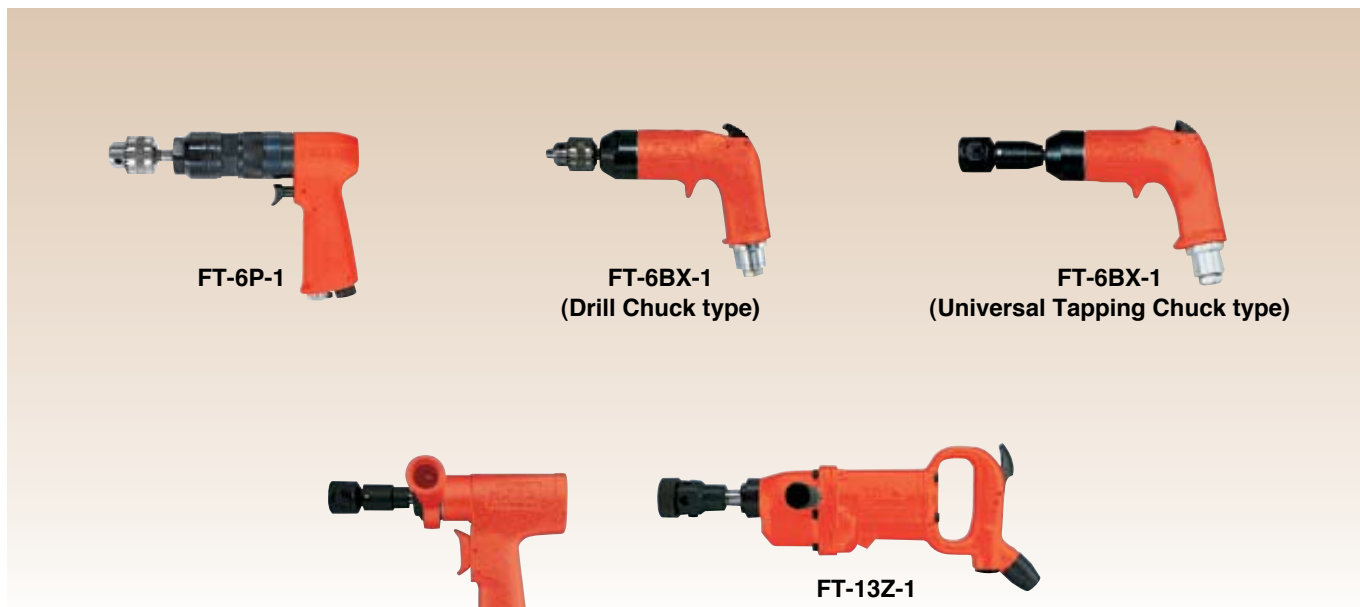

Model	Type	Tapping Capacity (Guidance)				Rotational Frequency (min ⁻¹)		Type and Size of Spindle Taper #	Chuck Capacity	Overall Length		Mass		Max. Air Consumption		Air Hose Size	
		Steel		Aluminum						mm	in	kg	lb	m ³ /min	ft ³ /min	mm	in
		mm	in	mm	in	R	L										
FT-6P-1	-	6	1/4	8	5/16	1,000	1,000	J.T.#1	8	236	9 19/64	1.8	4.0	0.50	17.7	9.5	3/8
FT-6BX-1	D	6	1/4	8	5/16	2,000	2,000	J.T.#1	6.5	205	8 7/64	1.3	2.9	0.56	19.8	8.0	5/16
FT-6BX-1	T	6	1/4	8	5/16	2,000	2,000	J.T.#1	8	240	9 29/64	1.3	2.9	0.56	19.8	8.0	5/16
FT-8PX-1	-	8	5/16	10	3/8	450	450	M.T.#1	9	232	9 9/64	2.0	4.4	0.50	17.7	9.5	3/8
FT-13Z-1	-	13	1/2	-	-	400	480	J.T.#6	13	384	15 1/8	4.0	8.8	1.25	44.1	12.7	1/2

*FT-6P-1, 6BX-1, 8PX-1: 1/4" Air Inlet Thread Size.

*FT-13Z-1: 3/8" Air Inlet Thread Size.

*TYPE: D...Drill Chuck, T...Tapping Chuck.

Tapping Chucks



No.	Models	Type and Size of Spindle Taper #	Chuck Capacity
TCK-6	FT-6BX-1T	J.T.#1	8mm
TCK-8F	FT-8PX-1	M.T.#1	9mm
TCK-13-1	FT-13Z-1	J.T.#6	13mm

Drill Chucks



No.	Models	Type and Size of Spindle Taper #	Chuck Capacity
DCK-6.5J	FT-6BX-1 (D Type)	J.T.#1	6.5mm
DCK-8J	FT-6P-1	J.T.#1	8mm

Percussive Tools

FEATURES	80
FLUX CHIPPERS	82
LIGHT HAMMERS	82
CHIPPING & CALKING HAMMERS	83
RIVETING HAMMERS	83
CONCRETE BREAKERS	83
NEEDLE SCALERS	84
SCALING HAMMERS	84
SAND RAMMERS	85
[Accessories-Percussive Tools]	86

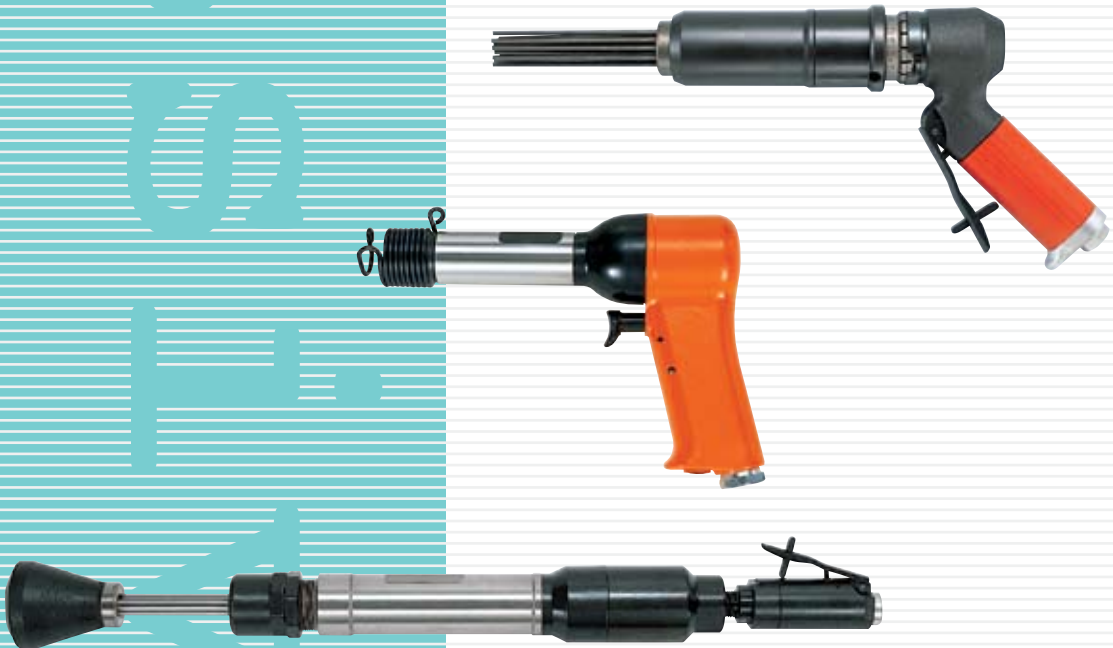

FEATURES

1 VALVE MECHANISM

Equipped with following valve mechanism, Fuji Percussion Tools have trouble-free long life.

A. PLATE VALVE

Plate valve consists of four parts of valve sheet, valve cover, valve case and valve. This simple mechanism and plate valve surface provide longer durability.

FC Series and FR Series

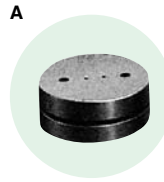

B. SLEEVE VALVE

Hollow valve enables a light and compact body and longer stroke for its size.

FRH Series



C. PISTON VALVE

High blow frequency (60Hz to 90Hz) can be maintained as this piston functions as a valve providing high working efficiency.

FCH Series, FNS Series and FS Series



2 LOW AIR CONSUMPTION

Low air consumption 0.14-0.18 m³/min (due to the valve mechanism) enables Fuji Percussion Tools to be used with a smaller compressor.

FCH Series and FNS Series



3 QUICK CHANGE ATTACHMENTS FOR PERCUSSIVE TOOLS

Attachment, such as chisels and needles, can be quickly and easily changed.

FCH Series and FNS Series



4 MULTI-NEEDLES

Fuji Needle Scalers utilise multiple needles that do not contaminate the workpiece.

FNS Series



5 PLASTIC HANDLE COVER

The plastic handle cover reduces the effect of vibration and provides an insulated grip for the operator.

FNS-2P, 2P-1F



6 SCALING HEADS

Three models are available to suit different applications- single head, dual head and triple heads.

FS Series



7 LOCKING HANDLE

The locking handle are designed to reduce the risk of accidental starting of the tools. The handle is automatically locked when the operator releases the handle.

A. Locking Roll Handle

FS Series

B. Locking Lever Handle

FS, FR, FCH, FNS Series

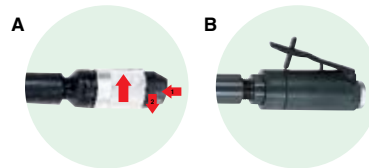

8 TUNGSTEN CARBIDE TIPPED PISTON (OPTION)

4-point Tungsten Carbide Piston is available on request for heavy removal operations.

FS Series



9 LOW BLOW FREQUENCY

The built-in Sleeve Valve allows the operator to adjust the blow frequency by adjusting the throttle valve.

FRH Series



10 CHISEL RETAINER

A. Holder Spring (Bee-Hive Retainer)

B. Holder Spring (B) (Quick Change Retainer)

FRH Series, FC-01SA

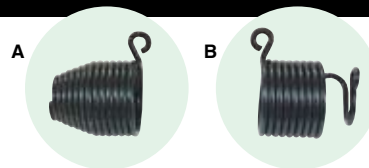

11 CHISEL HOLDER

Fuji Chipping and Calking Hammers are supplied with a chisel retainer as standard. This reduces the risk of the chisel releasing during operation.

FC Series

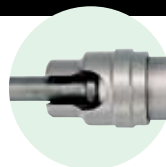

Flux Chippers/Light Hammers

FLUX CHIPPERS

Fuji offers 3 variants of Flux Chippers with different removal rates. They are ideal for various removal operations; light chipping, carving stone, scaling, removing paint, rust, weld flux and light fins from castings. FCH-25B offers a "blow" function which is ideal for blowing particles away from the work piece.

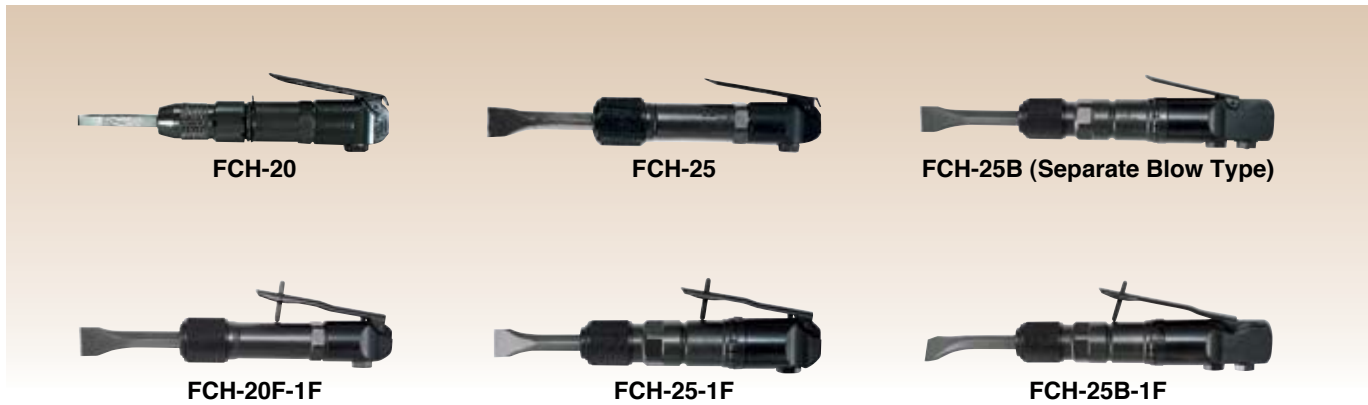

Model		Blows	Piston Diameter		Stroke		Overall Length		Mass		Air Consumption (At Load)		Air Inlet Thread Size	Air Hose Size	
Push Lever	Locking Lever	Hz	mm	in	mm	in	mm	in	kg	lb	m ³ /min	ft ³ /min	PT or NPT	mm	in
FCH-20	FCH-20-1F	90	20	25/32	16	5/8	176	6 13/64	0.8	1.8	0.14	4.9	1/4	6.3	1/4
FCH-20F	FCH-20F-1F	90	20	25/32	16	5/8	182	7 5/32	1.0	2.2	0.14	4.9	1/4	9.5	3/8
FCH-25	FCH-25-1F	60	25	1	20	25/32	204	8 1/32	1.5	3.3	0.18	6.4	1/4	9.5	3/8
FCH-25B	FCH-25B-1F	60	25	1	20	25/32	239	9 13/32	1.7	3.7	0.18	6.4	1/4	8.0	5/16

LIGHT HAMMERS

Fuji Light Hammers provide a controllable impact for rivetting to reduce the effect of work hardening of the rivet or damage to the surrounding metal. These tools are easily adapted to perform other operations, such as cutting, ripping, shearing, punching and gouging with suitable chisels fitted.



Model	Chisel Shank	Riveting Capacity (mm)		Blows	Piston Diameter		Stroke		Overall Length		Mass		Air Consumption (At Load)		Air Inlet Thread Size	Air Hose Size	
		Duralmin	Steel		Hz	mm	in	mm	in	mm	in	kg	lb	m ³ /min		ft ³ /min	PT or NPT
FRH-3-1	Hex	3.2	2.5	60	14.3	9/16	38.0	1 1/2	140	5 33/64	1.1	2.4	0.35	12.4	1/4	9.5	3/8
FRH-3-2	Round	3.2	2.5	60	14.3	9/16	38.0	1 1/2	140	5 33/64	1.1	2.4	0.35	12.4	1/4	9.5	3/8
FRH-6-1	Hex	6.4	5.0	30	12.7	1/2	100.0	4	206	8 7/64	1.4	3.0	0.35	12.4	1/4	9.5	3/8
FRH-6-2	Round	6.4	5.0	30	12.7	1/2	100.0	4	206	8 7/64	1.4	3.0	0.35	12.4	1/4	9.5	3/8
FRH-6A-1	Hex	6.4	5.0	50	20.0	25/32	44.5	1 3/4	193	7 19/32	1.5	3.3	0.40	14.1	1/4	9.5	3/8
FRH-6A-2	Round	6.4	5.0	50	20.0	25/32	44.5	1 3/4	193	7 19/32	1.5	3.3	0.40	14.1	1/4	9.5	3/8

CHIPPING & CALKING HAMMERS

Fuji Chipping and Calking Hammers are powerful and durable. Offered with a stroke range between 45mm to 102mm they are ideal for numerous chipping applications for concrete, masonry, weld flux and demolition applications.



Model	Chisel Shank	Chisel Shank Size		Blows	Piston Diameter		Stroke		Overall Length		Mass		Air Consumption (At Load)		Air Inlet Thread Size	Air Hose Size	
		mm	Hz		mm	in	mm	in	mm	in	kg	lb	m³/min	ft³/min		mm	in
FC-01SA-H	Hex	12 x 45	50	20.0	25/32	44.5	1 3/4	273	10 3/4	2.5	5.5	0.42	14.8	1/4	9.5	3/8	
FC-01SA-R	Round	14 x 45	50	20.0	25/32	44.5	1 3/4	273	10 3/4	2.5	5.5	0.42	14.8	1/4	9.5	3/8	
FC-01-3	Hex	12 x 45	50	20.0	25/32	44.5	1 3/4	273	10 3/4	2.6	5.7	0.42	14.8	1/4	9.5	3/8	
FC-01-4	Round	14 x 45	50	20.0	25/32	44.5	1 3/4	273	10 3/4	2.6	5.7	0.42	14.8	1/4	9.5	3/8	
FC-1Z-1	Hex	14.8 x 60	50	28.5	1 1/8	25	1	301	11 55/64	5.0	11.0	0.60	21.2	3/8	12.7	1/2	
FC-1Z-2	Round	17.5 x 60	50	28.5	1 1/8	25	1	301	11 55/64	5.0	11.0	0.60	21.2	3/8	12.7	1/2	
FC-2Z-1	Hex	14.8 x 60	42	28.5	1 1/8	51	2	342	13 15/32	5.7	12.5	0.60	21.2	3/8	12.7	1/2	
FC-2Z-2	Round	17.5 x 60	42	28.5	1 1/8	51	2	342	13 15/32	5.7	12.5	0.60	21.2	3/8	12.7	1/2	
FC-3Z-1	Hex	14.8 x 60	38	28.5	1 1/8	76	3	386	15 13/64	6.3	13.9	0.65	23.0	3/8	12.7	1/2	
FC-3Z-2	Round	17.5 x 60	38	28.5	1 1/8	76	3	386	15 13/64	6.3	13.9	0.65	23.0	3/8	12.7	1/2	
FC-4Z-1	Hex	14.8 x 60	28	28.5	1 1/8	102	4	425	16 47/64	6.8	15.0	0.65	23.0	3/8	12.7	1/2	
FC-4Z-2	Round	17.5 x 60	28	28.5	1 1/8	102	4	425	16 47/64	6.8	15.0	0.65	23.0	3/8	12.7	1/2	

RIVETING HAMMERS

These Heavy Duty Riveting Hammers are indispensable for various riveting jobs in heavy industry. They feature wide riveting capacities, high power, high blow frequency, low maintenance and long life.



Model	Riveting Capacity (Hot)		Blows	Piston Diameter		Piston Length		Stroke		Shank Size	Overall Length		Mass		Air Consumption (At Load)	
	mm	in		Hz	mm	in	mm	in	mm		in	mm	in	kg	lb	m³/min
B-40	15.9	5/8	25	27	1 1/16	50.8	2	100	4	30.95 x 70	387	15 1/4	7.9	17.3	1.00	35.3
B-50	19.0	5/8	23	27	1 1/16	57.0	2 1/4	125	5	30.95 x 70	413	16 1/4	8.3	18.2	1.00	35.3
B-60	22.2	7/8	23	27	1 1/16	57.0	2 1/4	150	6	30.95 x 70	438	17 1/4	8.8	19.3	1.00	35.3
B-80	28.6	1 1/8	18	27	1 1/16	63.5	2 1/2	203	8	30.95 x 70	489	19 1/4	9.8	21.5	1.10	38.8
B-90	31.8	1 1/4	15	27	1 1/16	76.0	3	230	9	30.95 x 70	514	20 1/4	10.2	22.4	1.20	42.4

*3/8" Air Inlet, 12.7mm(1/2") Air Hose.

CONCRETE BREAKERS

These Concrete Breakers are featured with rugged construction, strong breaking power, less reaction and handy design, and are widely used for various light and heavy breaking jobs.



Model	Chisel Shank	Chisel Shank Size		Blows	Piston Diameter		Stroke		Overall Length		Mass		Air Consumption (At Load)	
		mm	Hz		mm	in	mm	in	mm	in	kg	lb	m³/min	ft³/min
CB-10	Round	26 x 80	23	35	1 3/8	130	5 1/8	480	18 29/32	14.5	31.9	1.00	35.3	
CB-20	Round	30 x 88	14	40	1 37/64	165	6 1/2	550	21 48/64	20.0	44.0	1.20	42.4	
CB-30	Round	35 x 88	13	45	1 25/32	165	6 1/2	600	23 5/8	30.0	66.0	1.40	49.4	
CA-7	Round	26 x 80	22	35	1 3/8	120	4 3/4	460	18 1/8	7.8	17.1	0.90	31.8	

*19mm(3/4") Air Hose, 3/4" Air Inlet except 1/2" CB-10, 20 and 30.

Needle Scalers/Scaling Hammers

NEEDLE SCALERS

Fuji Needle Scalers are useful for removing weld flux, sand from castings, scales from forgings, rust, paint, scales from ship hulls and finishing rough surfaces of rock or concrete. Fuji Needle Scalers feature a unique valve less design and work well on uneven or irregular surfaces.

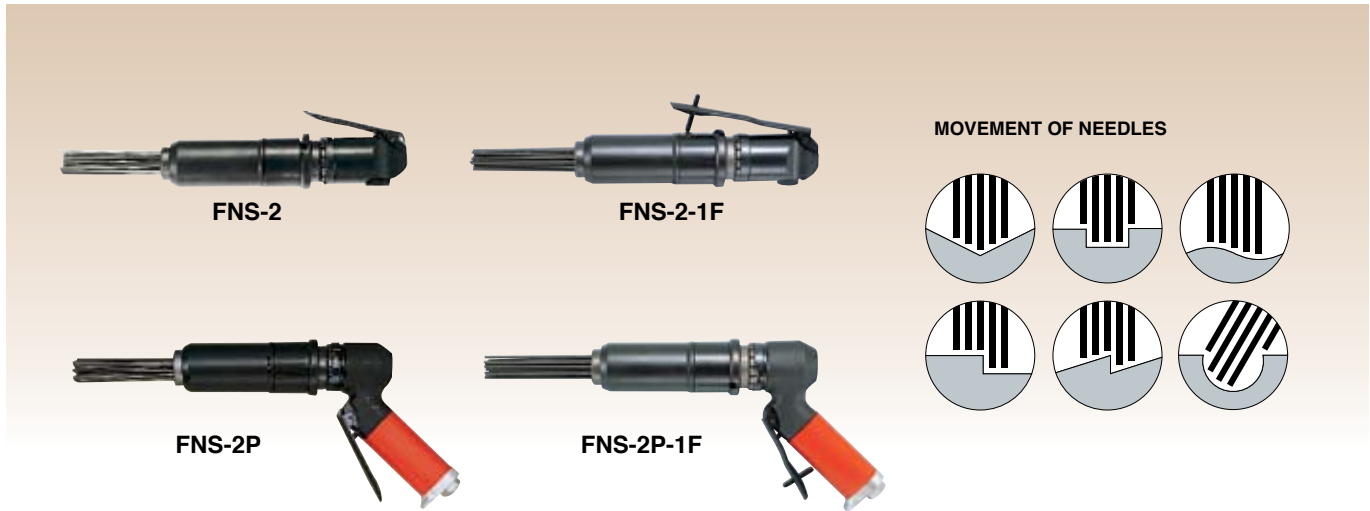

Model		Throttle Type	Blows	Piston Diameter		Needle Length		No. and Dia of Needle		Needle Stroke		Overall Length		Mass		Air Consumption (At Load)		Air Inlet Thread Size	Air Hose Size	
Push Lever	Locking Lever		Hz	mm	in	mm	in	3mm	2mm	mm	in	mm	in	kg	lb	m ³ /min	ft ³ /min	PT or NPT	mm	in
FNS-2	FNS-2-1F	Straight	133	25	1	180	7 3/32	19	37	7	9/32	325	12 51/64	1.9	4.1	0.18	6.4	1/4	9.5	3/8
FNS-2P	FNS-2P-1F	Pistol	133	25	1	180	7 3/32	19	37	7	9/32	371	14 39/64	2.5	5.5	0.18	6.4	1/4	9.5	3/8

*Specify needle diameter (3mm or 2mm) when ordering.

SCALING HAMMERS

Fuji offers 1, 2 and 3 Head Scaling Hammers. These tools have proven to be very efficient in cleaning heavily oxidized surfaces which occur on ships' hulls, bridges and storage tanks.

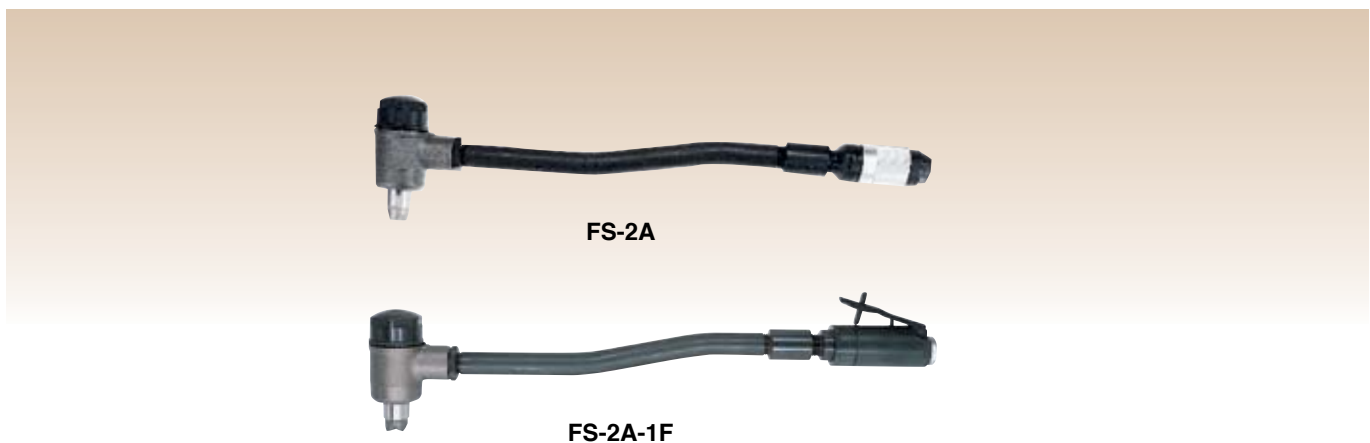

Model	Number of Cylinder	Blows	Piston Diameter		Stroke		Angle Height		Overall Length		Mass		Air Consumption (At Load)		Air Inlet Thread Size
		Hz	mm	in	mm	in	mm	in	mm	in	kg	lb	m ³ /min	ft ³ /min	PT or NPT
FS-2A	1	133	30	1 3/16	16	5/8	94	3 11/16	510(537)	20 5/64(21 9/64)	2.5	5.5	0.25	8.8	3/8
FS-2A-1F	1	133	30	1 3/16	16	5/8	94	3 11/16	510(537)	20 5/64(21 9/64)	2.5	5.5	0.25	8.8	3/8

*9.5mm (3/8") Air Hose.

SAND RAMMERS

Fuji Sand Rammers are powerful but light with a stroke range from 50mm to 127mm. Fuji Sand Rammers are excellent for ramming sand for casting in any ferrous or non-ferrous foundry. Non-rotary type rammers are available for use with irregular shaped butts.

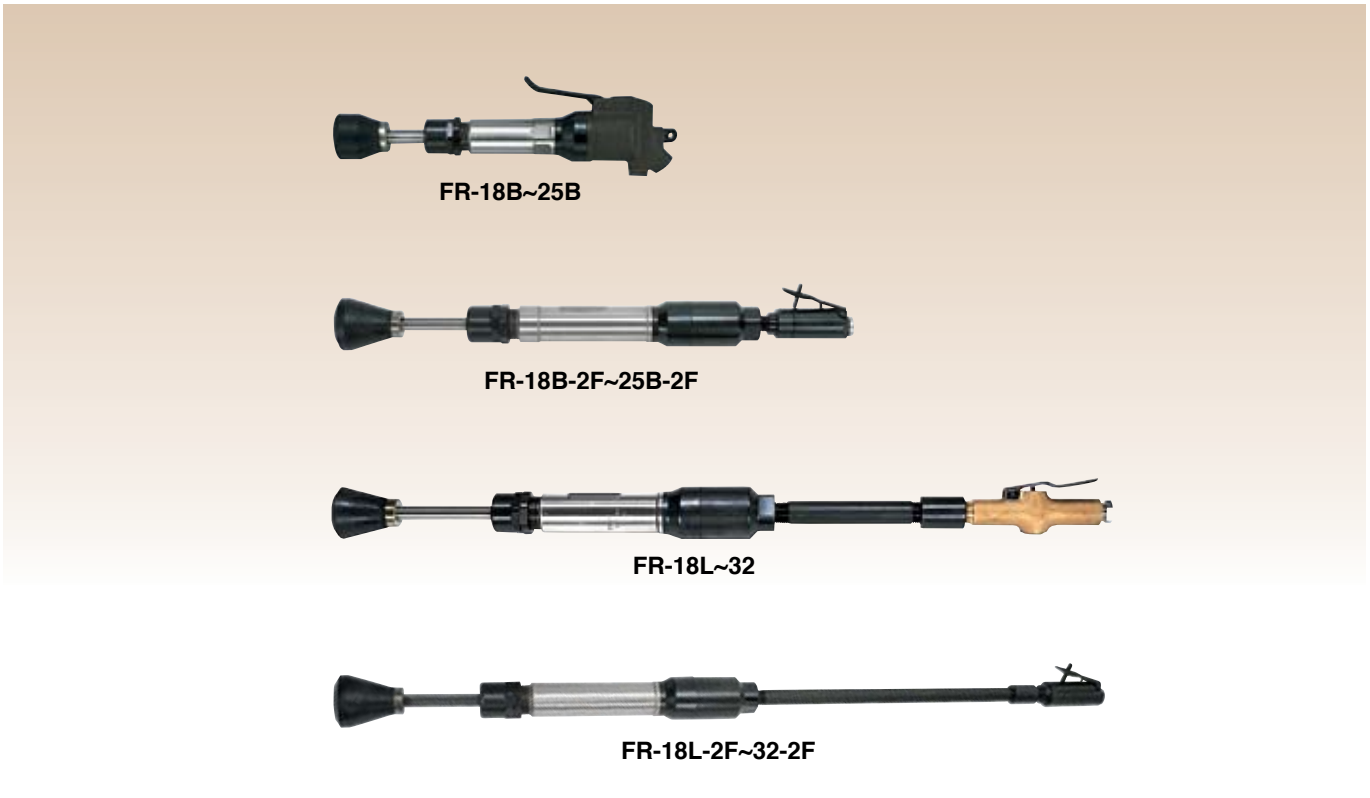

Model		Blows	Piston Diameter		Stroke		Butt Diameter		Overall Length		Mass		Air Consumption (At Load)		Air Inlet Thread Size	Air Hose Size	
Push Lever	Locking Lever		mm	in	mm	in	mm	in	mm	in	kg	lb	m ³ /min	ft ³ /min	PT or NPT	mm	in
FR-18B	FR-18B-2F	30	18.0	45/64	50	1 31/32	41	1 5/8	280(383)	11 1/32(15 5/64)	1.5	3.3	0.40	14.1	1/4	9.5	3/8
FR-22B	FR-22B-2F	17	22.0	55/64	64	2 33/64	51	2 1/32	350(451)	13 25/32(17 3/4)	3.0	6.6	0.50	17.7	3/8	9.5	3/8
FR-25B	FR-25B-2F	13	25.4	1	83	3 17/64	67	2 41/64	506(597)	19 59/64(23 1/2)	5.5	12.1	0.70	24.7	3/8	12.7	1/2
FR-18L	FR-18L-2F	30	18.0	45/64	50	1 31/32	41	1 5/8	558(523)	21 31/32(20 19/32)	2.0	4.4	0.40	14.1	1/4	9.5	3/8
FR-22L	FR-22L-2F	17	22.0	55/64	64	2 33/64	51	2 1/32	633(600)	24 59/64(23 5/8)	3.3	7.2	0.50	17.7	1/4	9.5	3/8
FR-25L	FR-25L-2F	13	25.4	1	83	3 17/64	67	2 41/64	1,043(1,005)	41 1/16(39 9/16)	6.0	13.2	0.70	24.7	1/2	12.7	1/2
FR-32	FR-32-2F	12	32.0	1 17/64	127	5	75	2 61/64	1,086(1,090)	42 3/4(42 29/32)	10.0	22.0	0.80	28.2	1/2	12.7	1/2

CHISELS FOR FCH-20

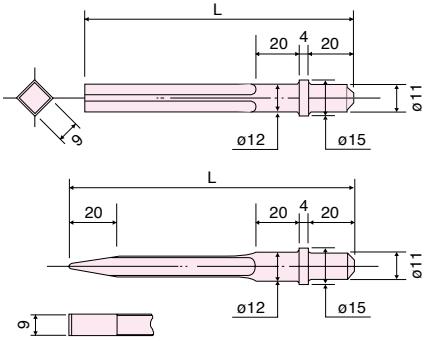

Type	AC No.	Size
		L mm
Blank	G-1-1	125
	G-1-2	155
	G-1-3	200
	G-1-4	250
	G-1-5	300
Flat	G-2-1	130
	G-2-2	155
	G-2-3	200
	G-2-4	250
	G-2-5	300

TIPPED CHISELS FOR FCH-20

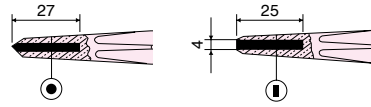

Type	AC No.	Overall Length	Remark
		mm	
Point	S-1	120	Standard
	S-3	160	Small Point
Flat	S-2	120	Standard
	S-4-1	160	Small Flat

BUSHING CHISELS FOR FCH-20



AC No.	Tip Size	
	Point	I x w x L
TWH-0006	4	2.5 x 2.5 x 5

CHISELS FOR FCH-20F, 25 AND 25B

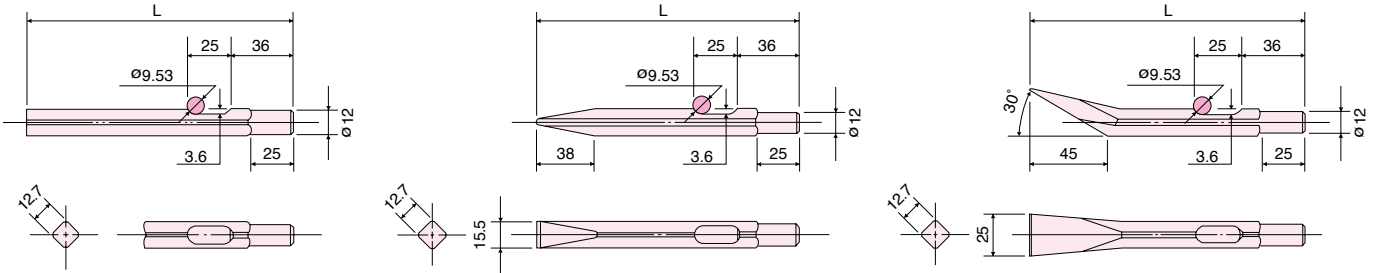

Type	AC No.	Size
		L mm
Blank	F-1-1	140
	F-1-2	155
	F-1-3	200
	F-1-4	250
	F-1-5	300

Type	AC No.	Size
		L mm
Flat	F-2-2	155
	F-2-3	200
	F-2-4	250
	F-2-5	300
	F-2-7	400

Type	AC No.	Size
		L mm
Flux	F-3-2	155
	F-3-3	200
	F-3-4	250
	F-3-5	300
	F-3-7	400

BUSHING CHISELS FOR FCH-20F, 25 AND 25B



AC No.	Tip Size	
	Point	I x w x L
TWH-0007	4	6 x 6 x 12
TWH-0003	9	5 x 5 x 15
TWH-0002	16	4 x 4 x 16
TWH-0004	25	4.5 x 4.5 x 22.5

CHISELS FOR FRH SERIES

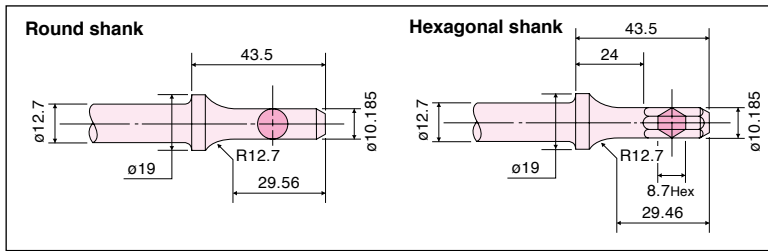

Index No.	AC No.		Part Name
	Round	Hexagonal	
808	WA-808	WA-808H	Muffler Cutter
809	WA-809	WA-809H	Double Edge Panel Cutter
810	WA-810	WA-810H	Flat Chisel
812	WA-812	WA-812H	Taper Punch
813	WA-813	WA-813H	Rivet Cutter
814	WA-814	WA-814H	Blank Chisel
815	WA-815	WA-815H	Spot Weld Breaker

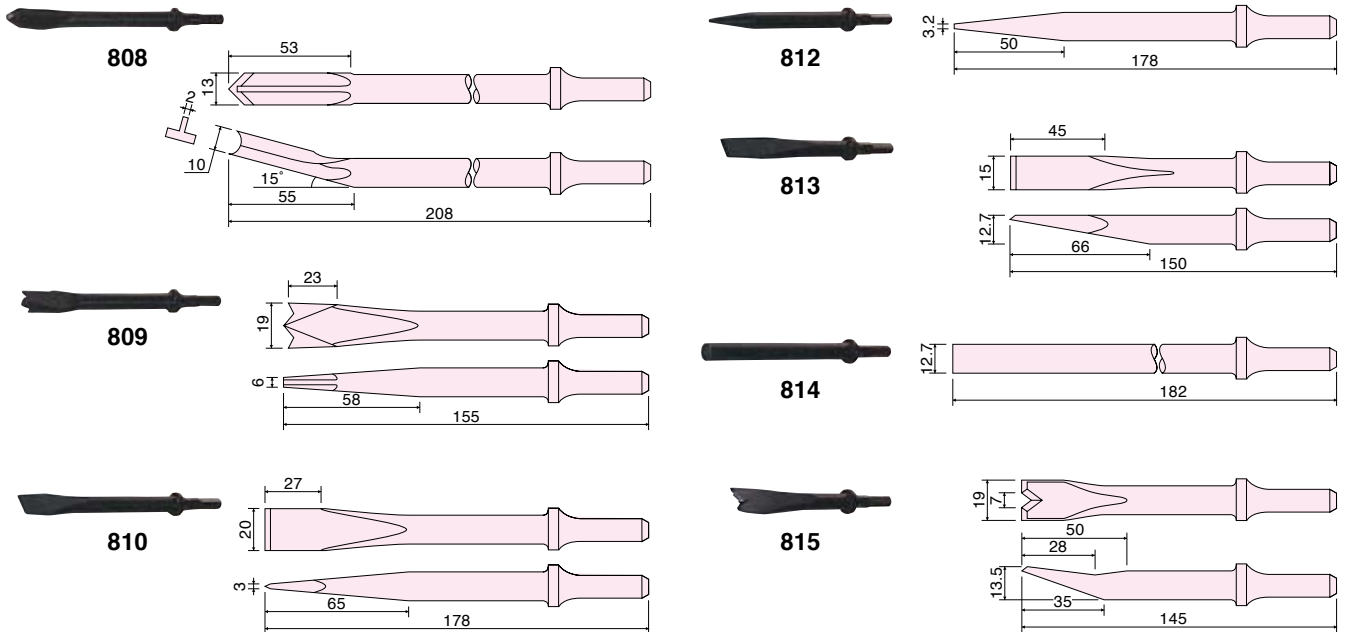

RETAINER FOR FRH AND FC-01SA SERIES



Holder Spring Holder Spring (B)

Part No.			Part Name
FC-01SA	FRH-3, 6	FRH-6A	
H-043715-00	H-019715-00	H-024715-00	Holder Spring
H-043719-00	H-019719-00	H-024719-01	Holder Spring (B)

RIVET SNAPS FOR FRH SERIES

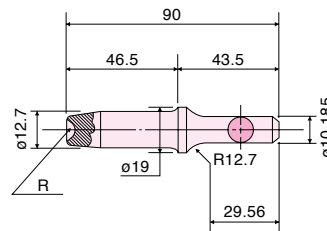

AC No.	R Size	Rivet Size
	mm	mm
SNAP-3	3.0	3
SNAP-4	3.7	4
SNAP-5	4.8	5
SNAP-6	5.1	6

CHISEL HOLDERS FOR FC SERIES

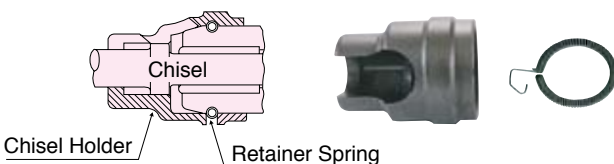

Part No.		Part Name
FC-01	FC-1Z~4Z	
H-059714-00	H-047714-01	Chisel Holder
H-059761-00	H-047761-00	Retainer Spring

BUTTON-HEAD RIVET SNAPS FOR B SERIES

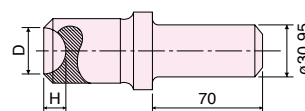

AC No.	Button Head Rivet		Rivet Snap Dimensions (mm)	
	Rivet Diameter		D	H
	mm	in		
SNAP-50	10	3/8	15.8	6.5
SNAP-51	13	1/2	20.5	8.3
SNAP-52	16	5/8	25.5	10.2
SNAP-53	19	3/4	29.5	12.5
SNAP-54	22	7/8	34.5	14.4
SNAP-55	25	1	39.5	16.2

*Other sizes are available on request.

*Please specify the dimensions of D and H when inquiring.

CHISELS FOR FC-SERIES

CHISELS / MODELS REFERENCE

Sign	Shape of Chisel Bush	Model	Sign	Shape of Chisel Bush	Model	Sign	Chisel End Shape
WJ-	Round	FC-01-4	WG-	Round	FC-1Z-2~4Z-2	P	Point
WJB-	Hex	FC-01-3	WH-	Hex	FC-1Z-1~4Z-1	F	Flat
						SL	Scaling

CHISELS SHANK SIZE

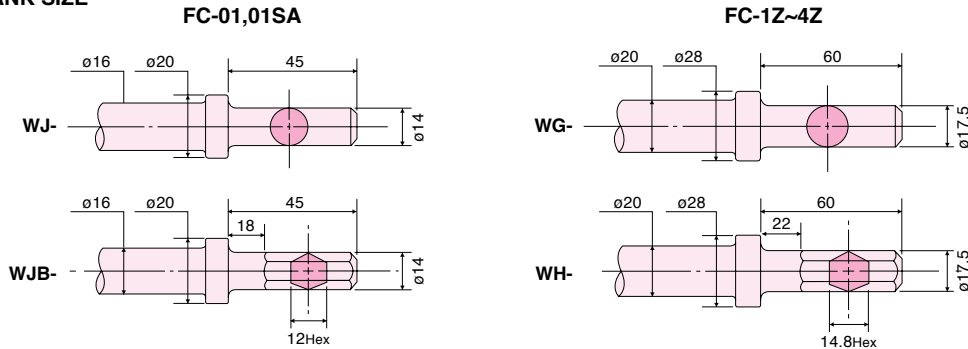

SHAPES OF CHISEL ENDS

Blank Chisels

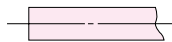

AC No.	Overall Length mm	Chisel Shank	Model
WJ-8	200	Round	FC-01-4 FC-01SA
WJ-10	250		
WJ-12	300		
WJ-16	400		
WJB-8	200	Hex	FC-01-3 FC-01SA
WJB-10	250		
WJB-12	300		
WJB-16	400		
WG-10	250	Round	FC-1Z-2~ 4Z-2
WG-12	300		
WH-10	250	Hex	FC-1Z-1~ 4Z-1
WH-12	300		

Point Chisels (P)

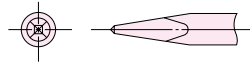

AC No.	Overall Length mm	Chisel Shank	Model
WJ-8F	200	Round	FC-01-4 FC-01SA
WJB-8F	200	Hex	FC-01-3 FC-01SA
WG-8F	200	Round	FC-1Z-2~ 4Z-2
WG-10F	250		
WH-8F	200	Hex	FC-1Z-1~ 4Z-1
WH-10F	250		

Flat Chisels (F)

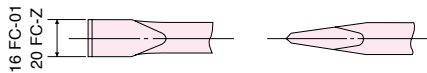

AC No.	Overall Length mm	Chisel Shank	Model
WJ-8P	200	Round	FC-01-4 FC-01SA
WJB-8P	200	Hex	FC-01-3 FC-01SA
WJB-10P	250	Round	FC-1Z-2~ 4Z-2
WG-8P	200		
WG-10P	250	Hex	FC-1Z-1~ 4Z-1
WH-8P	200		
WH-10P	250		

Scaling Chisels (SL)

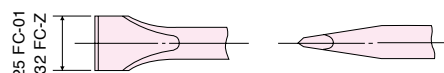

AC No.	Overall Length mm	Chisel Shank	Model
WJ-8SL	200	Round	FC-01-4 FC-01SA
WJB-8SL	200	Hex	FC-01-3 FC-01SA
WJB-10SL	250	Round	FC-1Z-2~ 4Z-2
WG-8SL	200		
WG-10SL	250	Hex	FC-1Z-1~ 4Z-1
WH-8SL	200		
WH-10SL	250		

RUBBER BUTTS FOR FR-SERIES



AC No.	Size			Model
	D mm	d mm	H mm	
R-1	51	11.8	60	FR-18B, 18L
R-1-1	41	12.7	47	FR-18B, 18L
R-2	51	13.75	60	FR-22B, 22L
R-3	67	17.25	80	FR-25B, 25L
R-4	75	18.75	92	FR-32

Air Motors

[Air Motors]

AIR MOTORS 90

[Air Starters]

AIR STARTERS 92

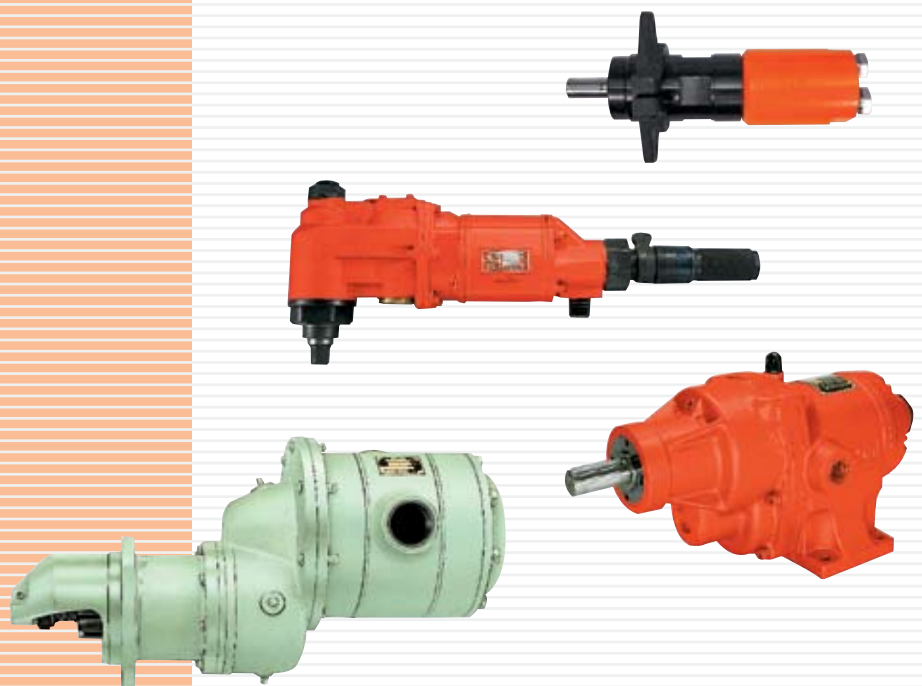

Air Motors

AIR MOTORS

Fuji Air Motors are compact and light weight, yet sturdy and offer high power-to-weight ratios. Fuji offers a wide range of air motors from small 0.1 kW hand-held motor to large 20 kW stationary motor which are found at versatile industries; ships, chemical plants, mines and power plants etc. As air motors are less likely to generate sparks (unlike brushes in electric motors), they are better suited for use in hazardous environments.

REVERSIBLE TYPE

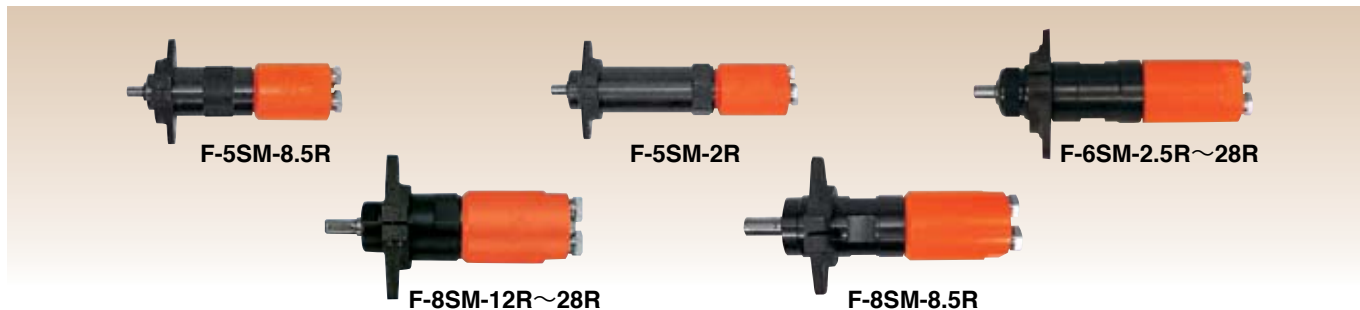

Model	Stall Torque			Horse Power		Rotational Frequency min ⁻¹	Overall Length		Mass		Max. Air Consumption		Air Inlet Thread Size PT or NPT	Air Hose Size	
	N · m	kgf · m	ft · lb	kW	PS		mm	in	kg	lb	m ³ /min	ft ³ /min		mm	in
F-5SM-8.5R	5.4	0.55	4.0	0.12	0.16	850	147	5 51/64	0.6	1.3	0.28	9.9	1/8	6.3	1/4
F-5SM-2R	21.6	2.20	15.9	0.10	0.14	190	182	7 11/16	0.8	1.8	0.28	9.9	1/8	6.3	1/4
F-6SM-28R	3.3	0.34	2.5	0.25	0.34	2,300	147	5 51/64	0.8	1.8	0.34	12.0	1/8	8.0	5/16
F-6SM-21R	4.0	0.41	3.0	0.26	0.35	2,000	146	5 3/4	0.9	2.0	0.34	12.0	1/8	8.0	5/16
F-6SM-12R	5.9	0.60	4.3	0.23	0.31	1,000	157	6 3/16	0.8	1.8	0.34	12.0	1/8	8.0	5/16
F-6SM-8R	9.8	1.00	7.2	0.23	0.31	750	179	7 1/16	1.0	2.2	0.34	12.0	1/8	8.0	5/16
F-6SM-5R	14.7	1.50	10.8	0.22	0.30	500	180	7 3/32	1.0	2.2	0.34	12.0	1/8	8.0	5/16
F-6SM-2.5R	26.0	2.65	19.2	0.21	0.29	250	192	7 9/16	1.2	2.6	0.34	12.0	1/8	8.0	5/16
F-8SM-28R	6.4	0.65	4.7	0.38	0.52	2,300	183	7 13/64	1.5	3.3	0.50	17.7	1/4	9.5	3/8
F-8SM-12R	9.8	1.00	7.2	0.37	0.50	1,100	199	7 53/64	2.2	4.8	0.50	17.7	1/4	9.5	3/8
F-8SM-8.5R	14.7	1.50	10.8	0.37	0.50	850	222	8 3/4	2.4	5.3	0.50	17.7	1/4	9.5	3/8

*Specify type of spindle when ordering.

NON-REVERSIBLE TYPE

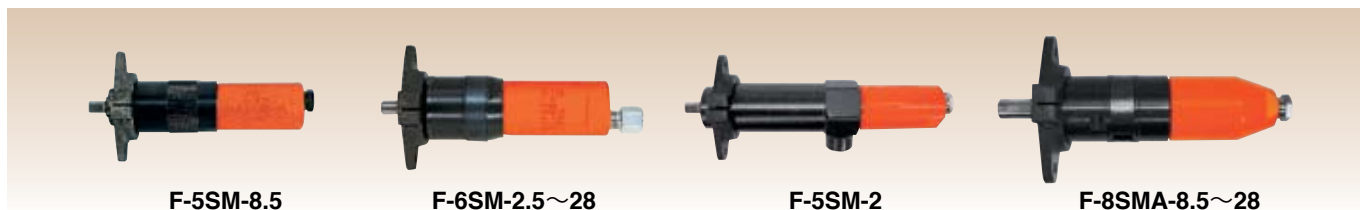

Model	Stall Torque			Horse Power		Rotational Frequency min ⁻¹	Overall Length		Mass		Max. Air Consumption		Air Inlet Thread Size PT or NPT	Air Hose Size	
	N · m	kgf · m	ft · lb	kW	PS		mm	in	kg	lb	m ³ /min	ft ³ /min		mm	in
F-5SM-8.5	5.9	0.60	4.3	0.13	0.18	950	153	6 1/32	0.6	1.3	0.28	9.9	1/8	6.3	1/4
F-5SM-2	23.5	2.40	17.4	0.12	0.16	200	187	7 3/8	0.9	2.0	0.28	9.9	1/8	6.3	1/4
F-6SM-28	3.9	0.40	2.9	0.29	0.40	2,800	167	6 37/64	0.7	1.5	0.34	12.0	1/4	9.5	3/8
F-6SM-21	4.4	0.45	3.3	0.29	0.40	2,400	167	6 37/64	0.8	1.8	0.34	12.0	1/4	9.5	3/8
F-6SM-12	7.4	0.75	5.4	0.29	0.40	1,300	181	7 1/8	0.9	2.0	0.34	12.0	1/4	9.5	3/8
F-6SM-8	10.8	1.10	8.0	0.26	0.35	900	200	7 7/8	1.0	2.2	0.34	12.0	1/4	9.5	3/8
F-6SM-5	15.7	1.60	11.6	0.26	0.35	600	200	7 7/8	1.0	2.2	0.34	12.0	1/4	9.5	3/8
F-6SM-2.5	28.4	2.90	21.0	0.26	0.35	300	213	8 25/64	1.2	2.6	0.34	12.0	1/4	9.5	3/8
F-8SMA-28	5.9	0.60	4.3	0.44	0.60	2,600	171	6 47/64	1.5	3.3	0.50	17.7	1/4	9.5	3/8
F-8SMA-12	11.8	1.20	8.7	0.44	0.60	1,300	200	7 7/8	2.0	4.4	0.50	17.7	1/4	9.5	3/8
F-8SMA-8.5	16.7	1.70	12.3	0.44	0.60	900	208	8 3/16	2.2	4.8	0.50	17.7	1/4	9.5	3/8

*Specify type of spindle when ordering.

Type of Spindle

Chord Type	Key Type	Thread Type		
Model	Model	*Model	Spindle Thread Size	Applicable Drill Chuck
F-5SM Series	F-8SMA Series	F-6SM-5, 8, 12, 21 F-8SMA-12, 28 F-6SE, 6SF, 6PFX	3/8-24(UNF)	DCK-6.5 DCK-8 DCK-10
F-6SM Series	F-8SM Series	F-8SMA-8.5 F-10MT	1/2-20(UNF)	DCK-13

*Drill chucks are applicable to thread type spindle models.

Hose Connection

Non-Reversible Type



Reversible Type

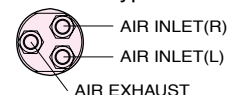

NON-REVERSIBLE TYPE

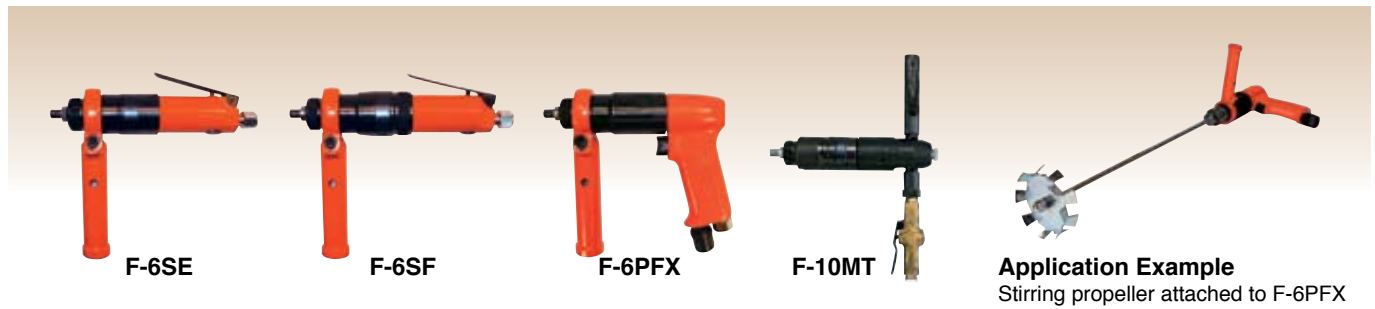

Model	Stall Torque			Horse Power		Rotational Frequency		Overall Length		Spindle Thread Size	Mass		Max. Air Consumption		Air Inlet Thread Size	Air Hose Size	
	N · m	kgf · m	ft · lb	kW	PS	min ⁻¹	mm	in	in	kg	lb	m ³ /min	ft ³ /min	PT or NPT	mm	in	
F-6SE	15.7	1.6	11.6	0.26	0.35	600	210	8 9/32	3/8-24UNF	1.0	2.2	0.42	14.8	1/4	9.5	3/8	
F-6SF	28.4	2.9	21.0	0.26	0.35	300	225	8 55/64	3/8-24UNF	1.1	2.4	0.43	15.2	1/4	9.5	3/8	
F-6PFX	28.4	2.9	21.0	0.26	0.35	300	184	7 1/4	3/8-24UNF	1.7	3.7	0.43	15.2	1/4	9.5	3/8	
F-10MT	78.5	8.0	57.8	0.37	0.50	180	270	10 41/64	1/2-20UNF	3.4	7.5	0.63	22.3	1/4	9.5	3/8	

*For application examples, please refer to the stirring propellers on page 76.

PORTABLE TYPE



Model	Stall Torque			Horse Power		Rotational Frequency(min ⁻¹)		Socket	Spindle Square Size	Overall Length		Mass		Max. Air Consumption		Air Inlet Thread Size	Air Hose Size	
	N · m	kgf · m	ft · lb	kW	PS	R	L	M.T.#	mm	mm	in	kg	lb	m ³ /min	ft ³ /min	PT or NPT	mm	in
FM-2R-2C	161.8	16.5	119.3	0.74	1.0	150	170	-	19	630	22 13/16	10.5	23.1	1.50	53.1	1/2	12.7	1/2
FNR-20	171.6	17.5	127.0	0.66	0.9	150	135	-	16	506	19 15/16	7.0	15.4	1.10	38.9	1/2	12.7	1/2
FNR-20S	171.6	17.5	127.0	0.66	0.9	150	135	-	16	506	19 15/16	7.0	15.4	1.10	38.9	1/2	12.7	1/2
FM-14RK-101	73.5	7.5	54.2	0.88	1.2	430	390	2	13	473	18 5/8	7.4	16.3	1.50	53.1	1/2	12.7	1/2
FM-24RK-101	166.6	16.6	120.0	1.69	2.3	350	310	3	14	579	22 51/64	13.5	29.7	2.25	79.6	1/2	19.0	3/4
FM-24RK-201	392.0	40.0	289.2	1.54	2.1	140	125	4	19	596	23 15/32	16.2	35.6	2.25	79.6	1/2	19.0	3/4
FM-27RK-101	745.0	76.0	549.5	1.90	2.6	85	75	5	31	652	25 43/64	20.0	44.0	2.50	88.5	1/2	19.0	3/4

*Stall Torque, Horse Power and Max. Air Consumption shown at this table are of clockwise rotation.

STATIONARY TYPE

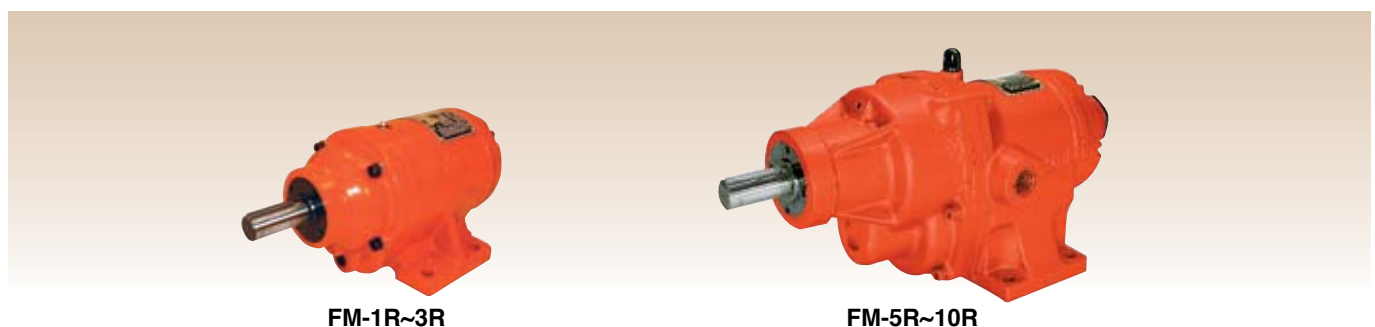

Model	Stall Torque			Horse Power		Rotational Frequency(min ⁻¹)		Overall Length		Mass		Max. Air Consumption		Air Inlet Thread Size	Air Hose Size	
	N · m	kgf · m	ft · lb	kW	PS	R	L	mm	in	kg	lb	m ³ /min	ft ³ /min	PT or NPT	mm	in
FM-1R-5	56.9	5.8	41.9	0.90	1.2	600	600	273	10 3/4	7.0	15.4	1.5	53.1	1/2	12.7	1/2
FM-1R-12	28.4	2.9	20.9	0.90	1.2	1,250	1,250	273	10 3/4	7.0	15.4	1.5	53.1	1/2	12.7	1/2
FM-2R-5	137.0	14.0	101.2	2.35	3.2	650	650	375	14 3/4	13.0	28.6	3.1	109.7	3/4	19.0	3/4
FM-3R-3	284.0	29.0	209.7	2.79	3.8	320	296	395	15 1/2	17.0	37.4	4.4	155.8	3/4	19.0	3/4
FM-3R-5	177.0	18.0	130.1	2.79	3.8	525	485	395	15 1/2	17.0	37.4	4.4	155.8	3/4	19.0	3/4
FM-5R-2	471.0	48.0	247.1	3.68	5.0	300	300	435	17 1/8	21.0	46.2	5.6	198.2	1	25.4	1
FM-10R-2	1,140.0	116.0	839.0	7.35	10.0	240	240	570	22 7/16	42.0	92.4	10.0	354.0	1 1/4	32.0	1/4

*Stall Torque, Horse Power and Max. Air Consumption shown at this table are of clockwise rotation.

Air Starters

AIR STARTERS

Fuji Air Starters are compact, light weight and ideal for starting gasoline and diesel engines in various industries. Compared to conventional electrical starters, Fuji air starters provide improved power to weight ratio and lower maintenance costs.



FSM-50C

FSM-70C, 100C

FSM-200C

Selection

Model	Exhaust Capacity of Engine	
	Diesel Engine	Gas and Gasoline Engines
FSM-50, 70	Up to 8,000c.c.	Up to 20,000c.c.
FSM-100	8,000~15,000c.c.	20,000~37,000c.c.
FSM-200	15,000~150,000c.c.	37,000~330,000c.c.

Fuji offers 4 series of air starter, FSM-50, 70, 100 and 200 with various pinion modules to meet the demands for most standard engines. Select suitable models in accordance with exhaust capacity of engine and pinion specifications. Air starter is also useful for the engines which are operated by electric starters.

Features

- Prompt reliable starting.
- Light weight and compact design.
- Stable output not effected by temperature change.
- No electrical hazards-safe for use in hazardous place of possible fire-damp.
- Maintain full cranking power under low temperature.
- No seize on the motor.

Dimension

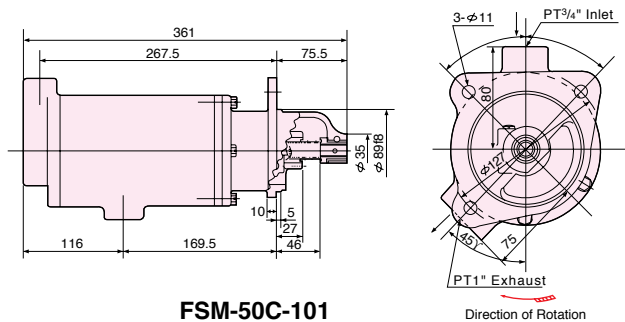

FSM-50C-101

Performance Curve

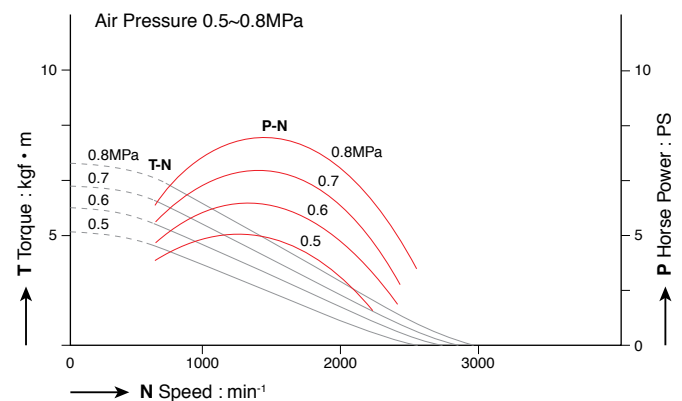

Model	Air Pressure		Horse Power		Max. Torque			Starting Torque				Max. Output				Overall Length		Mass		Max. Air Consumption	
	MPa	kgf/cm ²	kW	PS	N · m	kgf · m	ft · lb	N · m	kgf · m	ft · lb	Torque		Pinion Speed	mm	in	kg	lb	Max. Air Consumption			
											N · m	kgf · m						ft · lb	min ⁻¹	m ³ /min	ft ³ /min
FSM-50C-101	0.5	5	3.0	4.1	40.2	4.1	29.7	37.2	3.8	27.5	24.0	2.5	17.7	1,200	361	14 7/32	18	39.7	4.8	169.4	
	0.6	6	3.8	5.2	49.0	5.0	36.2	45.1	4.6	33.3	28.5	2.9	34.2	1,280					6.0	211.9	
	0.7	7	4.6	6.3	56.8	5.8	42.0	51.9	5.3	38.4	33.0	3.4	24.4	1,340					7.2	254.1	
	0.8	8	5.6	7.6	64.7	6.6	47.8	59.8	6.1	44.2	38.1	3.9	28.1	1,400					9.0	317.7	

*Air Inlet Thread Size: PT 3/4", Exhaust Size: PT 1".

Dimension

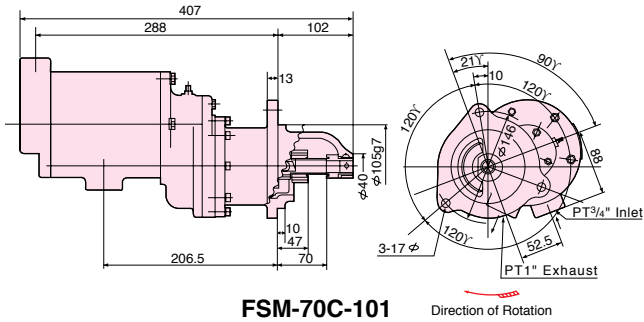

FSM-70C-101

Direction of Rotation

Performance Curve

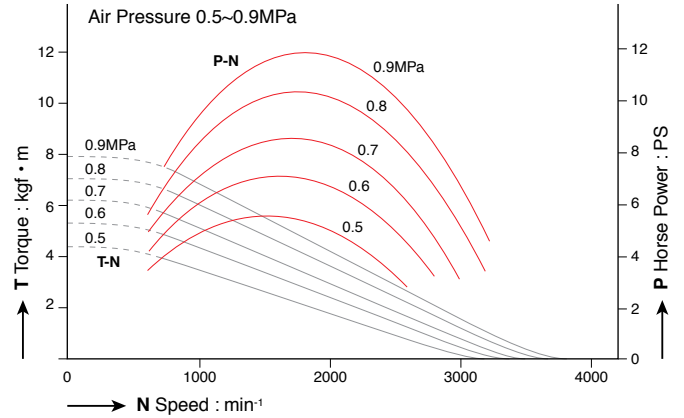

Model	Air Pressure		Horse Power		Max. Torque			Starting Torque			Max. Output Torque			Pinion Speed min ⁻¹	Overall Length		Mass		Max. Air Consumption	
	MPa	kgf/cm ²	kW	PS	N·m	kgf·m	ft·lb	N·m	kgf·m	ft·lb	N·m	kgf·m	ft·lb		mm	in	kg	lb	m ³ /min	ft ³ /min
FSM-70C-1**	0.5	5	4.0	5.5	43.1	4.4	31.8	39.2	4.0	29.0	25.4	2.6	18.7	1,520	409	16 7/64	24	52.9	6.6	232.9
	0.6	6	5.2	7.1	51.9	5.3	38.4	48.0	4.9	35.5	31.0	3.2	22.9	1,610					8.4	296.5
	0.7	7	6.3	8.5	60.8	6.2	44.9	55.9	5.7	41.9	35.5	3.6	26.2	1,680					10.2	360.0
	0.8	8	7.6	10.3	68.6	7.0	50.7	63.7	6.5	47.1	41.4	4.2	30.6	1,750					12.0	423.6
	0.9	9	8.7	11.8	77.4	7.9	57.2	71.5	7.3	52.9	45.8	4.7	33.8	1,810					13.8	487.1

*Air Inlet Thread Size: PT 3/4", Exhaust Size: PT 1".

Dimension

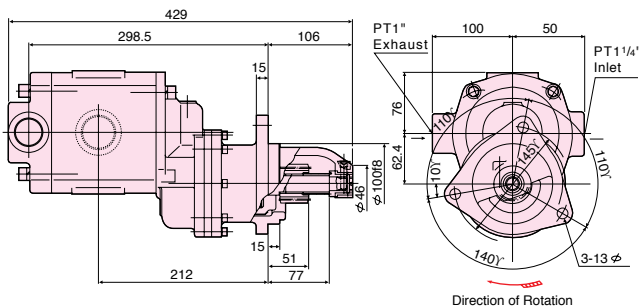

FSM-100C-101

Direction of Rotation

Performance Curve

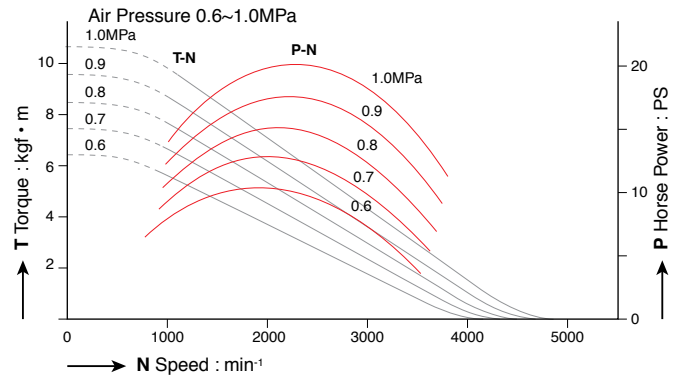

Model	Air Pressure		Horse Power		Max. Torque			Starting Torque			Max. Output Torque			Pinion Speed min ⁻¹	Overall Length		Mass		Max. Air Consumption	
	MPa	kgf/cm ²	kW	PS	N·m	kgf·m	ft·lb	N·m	kgf·m	ft·lb	N·m	kgf·m	ft·lb		mm	in	kg	lb	m ³ /min	ft ³ /min
FSM-100C-1**	0.6	6	7.6	10.4	63.7	6.5	47.1	58.8	6.0	43.5	27.5	3.8	20.3	1,950	429	16 57/64	30	66.1	12.0	423.6
	0.7	7	9.4	12.8	73.5	7.5	54.3	68.6	7.0	50.7	44.1	4.5	32.6	2,040					15.0	529.5
	0.8	8	11.1	15.1	84.3	8.6	62.3	77.4	7.9	57.2	50.0	5.1	37.0	2,120					17.4	614.2
	0.9	9	12.9	17.6	95.1	9.7	70.3	87.2	8.9	64.5	56.3	5.7	41.6	2,200					20.4	720.1
FSM-100C-2**	1.0	10	14.9	20.2	105.8	10.8	78.2	97.0	9.9	71.7	62.5	6.4	46.2	2,270	429	16 57/64	30	66.1	23.4	826.0
	0.6	6	7.6	10.4	80.3	8.2	59.4	71.5	7.3	52.9	47.3	4.8	35.0	1,550					12.0	423.6
	0.7	7	9.4	12.8	93.1	9.5	68.8	83.3	8.5	61.6	55.7	5.7	41.2	1,620					15.0	529.5
	0.8	8	11.1	15.1	106.8	10.9	79.0	94.0	9.6	69.5	63.2	6.4	46.7	1,680					17.4	614.2
FSM-100C-2**	0.9	9	12.9	17.6	120.5	12.3	89.1	106.8	10.9	79.0	71.1	7.3	52.6	1,740	429	16 57/64	30	66.1	20.4	720.1
	1.0	10	14.9	20.2	133.2	13.6	98.5	117.6	12.0	87.0	79.2	8.1	58.6	1,790					23.4	826.0

*Air Inlet Thread Size: PT 1", Exhaust Size: PT 1 1/4".

Air Starters

Dimension

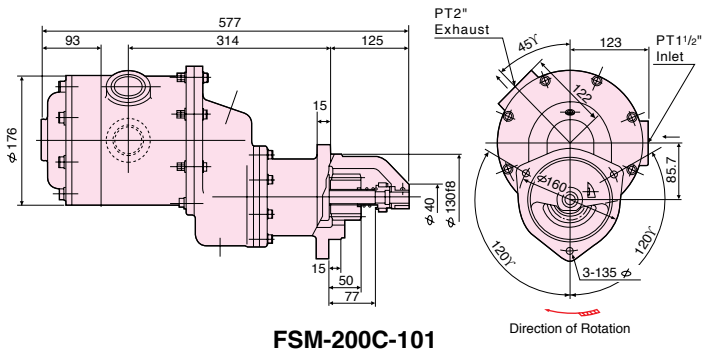

FSM-200C-101

Performance Curve

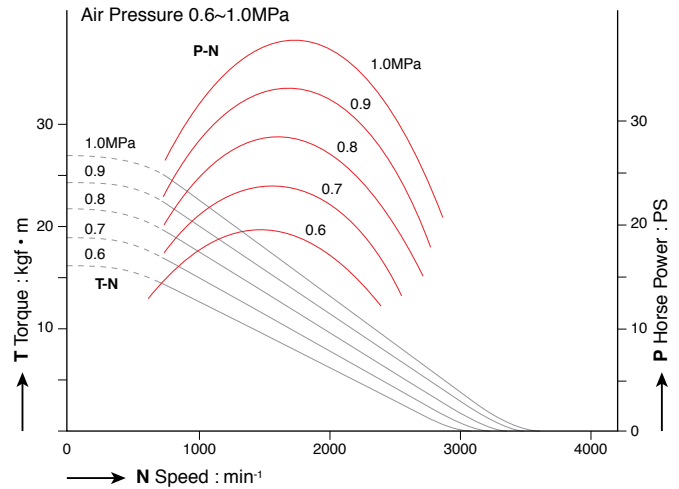

Model	Air Pressure		Horse Power		Max. Torque			Starting Torque			Max. Output				Overall Length		Mass		Max. Air Consumption	
	MPa	kgf/cm²	kW	PS	N·m	kgf·m	ft·lb	N·m	kgf·m	ft·lb	Torque	Pinion Speed	mm	in	kg	lb	m³/min	ft³/min		
FSM-200C-1**	0.6	6	14.3	19.4	156.3	16.0	115.6	144.1	14.7	106.6	92.5	9.4	68.4	1,470	577	22 23/32	60	132.3	22.8	804.8
	0.7	7	17.4	23.6	183.3	18.7	135.6	167.6	17.1	124.0	107.7	11.0	79.6	1,540					28.2	995.4
	0.8	8	20.7	28.2	208.7	21.3	154.4	192.1	19.6	142.1	123.4	12.6	91.3	1,610					33.6	1186.0
	0.9	9	24.2	32.9	235.2	24.0	174.0	216.0	22.1	159.8	139.0	14.2	102.8	1,660					39.0	1376.7
	1.0	10	27.6	37.6	260.7	26.6	192.9	240.1	24.5	177.6	154.5	15.6	114.3	1,710	44.4	1567.3				

*Air Inlet Thread Size: PT 1 1/2", Exhaust Size: PT 2".

Handling Care

SETTING UP

Proper and complete setting are required to air starter. Consult us when inquiring as setting position and shape of mounted flange vary with partnered engine. Poor setting causes poor gear engagement of pinion and ring gear, poor rotation and gear damage.

OPERATION

Close air valve soonest to shut-off air supply after air starter start the engine. If air pressure of air compressor is low, do not operate air starter until air pressure of tank reach 0.55 MPa or over after full charging it with compressed air.

Section of Driving Pinion and Ring Gear

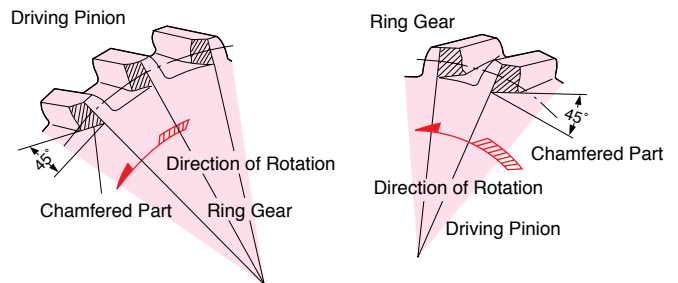

Driving Pinion Specification

Model	Module	Pitch Circle Dia	Number of Teeth	Outside Dia	Amount of Addendum Modification	Pressure Angle
		mm		mm	mm	
FSM-50C-101	3.0	33.0	11	40.64	+0.82	14.5°
FSM-70C-101	3.5	45.5	13	54.30	+0.90	14.5°
FSM-70C-101B	3.5	45.5	13	54.30	+0.90	14.5°
FSM-70C-102	3.0	33.0	11	40.64	+0.82	14.5°
FSM-70C-103	3.0	39.0	13	46.64	+0.819	14.5°
FSM-70C-104	3.0	33.0	11	40.64	+0.82	14.5°
FSM-70C-105	3.0	42.0	14	49.64	+0.82	14.5°
FSM-70C-106	3.0	33.0	11	41.38	+1.19	14.5°
FSM-100C-101	3.5	38.5	11	48.20	+1.35	14.5°
FSM-100C-102	3.5	38.5	11	48.20	+1.35	14.5°
FSM-100C-103	4.0	56.0	14	68.00	+2.00	14.5°
FSM-100C-104	3.0	39.0	13	46.64	+0.82	14.5°
FSM-100C-105	3.5	45.5	13	55.20	+1.35	14.5°
FSM-100C-201	4.0	48.0	12	60.00	+2.00	14.5°
FSM-100C-202	4.0	48.0	12	60.00	+2.00	14.5°
FSM-100C-203	4.0	48.0	12	60.00	+2.00	14.5°
FSM-200C-101	4.0	60.0	15	70.60	+1.30	14.5°
FSM-200C-102	4.0	60.0	15	70.60	+1.30	14.5°

Others

PIPE BEVELLING MACHINES	96
AUTOMATIC SEAL WELDERS	98
WELDING WIRE REWINDER	100
TUBE EXPANDERS	100
TIP DRESSERS	101
CHAMFERING MACHINES	102
ALUMINUM MILLING MACHINES	104
AIR FILES / AIR SAWS	105
SUMP PUMPS / PISTON PUMPS	106
MARKING PEN	107
DEBURRING TOOLS	107
AIR LINE HEATERS	108
AIR CLEANERS	108
AIR HOISTS (LINK CHAIN TYPE)	109
AIR WINCHES	110



Pipe Beveling Machines

PIPE BEVELLING MACHINES

Fuji Portable Pipe Beveling Machines feature a powerful motor, zero torque reaction, in-pipe chucking, and variable speed control to assure a precise and fast beveling operation. They are available with beveling capacities from 12mm through 240mm pipe inside diameter.



Model and Assortment	Capacity (Pipe inside Dia.)		Stall Torque			Rotational Frequency	Feed Length		Side to Center		Overall Length		Mass		Max. Air Consumption	
	mm	in	N · m	kgf · m	ft · lb		mm	in	mm	in	mm	in	kg	lb	m ³ /min	ft ³ /min
FBM-16-1(S)	12~16	15/32~5/8	25.0	2.6	18.8	290	20	51/64	19	3/4	261	10 17/64	2.6	5.7	0.40	14.1
FBM-24-1(S)	14~24	35/64~15/16	49.0	5.0	36.1	180	30	1 3/16	27	1 1/16	278	10 15/16	2.9	6.4	0.40	14.1
FBM-80A-2(S)	30~40	1 3/16~1 9/16	113.0	11.5	83.2	100	30	1 3/16	39	1 35/64	403	15 7/8	6.5	14.3	0.60	21.2
FBM-80A-3(S)	40~80	1 9/16~3 1/8	113.0	11.5	83.2	100	30	1 3/16	39	1 35/64	403	15 7/8	6.7	14.7	0.60	21.2
FBM-80A-4(S)	30~80	1 3/16~3 1/8	FBM-80A-4 is supplied with the Chuck Assemblies attached to FBM-80A-2 and FBM-80A-3.													
FBM-80A-5(S)	20~29	2 5/32~1 5/32	113.0	11.5	83.2	100	30	1 3/16	39	1 35/64	403	15 7/8	6.0	13.2	0.60	21.2
FBM-80A-6(S)	20~80	2 5/32~3 1/8	FBM-80A-6 is supplied with a full range of Chuck Assemblies and Tool Holder Assemblies.													
FBM-300-2(S)	80~120	3 9/64~4 23/32	431.0	44.0	318.2	75	60	2 23/64	56	2 13/64	524	20 5/8	23.7	52.1	1.60	56.5
FBM-300-3(S)	120~240	4 23/32~9 29/64	431.0	44.0	318.2	75	60	2 23/64	135	5 5/16	603	23 47/64	26.8	60.0	1.60	56.5
FBM-300-4(S)	80~240	3 9/64~9 29/64	Supplied with a full set of Chuck Assemblies and Tool Holder Assemblies.													

*FBM-16, 24, 80A: 1/4" Air Inlet thread, 8.0mm(5/16") Air Hose. FBM-300: 1/2" Air Inlet thread, 12.7mm(1/2") Air Hose.

*Optional Chuck Ass'y. for 240~300mm Pipe Beveling is also available on request.

*Models marked -*S are Self-return Roll handle types.

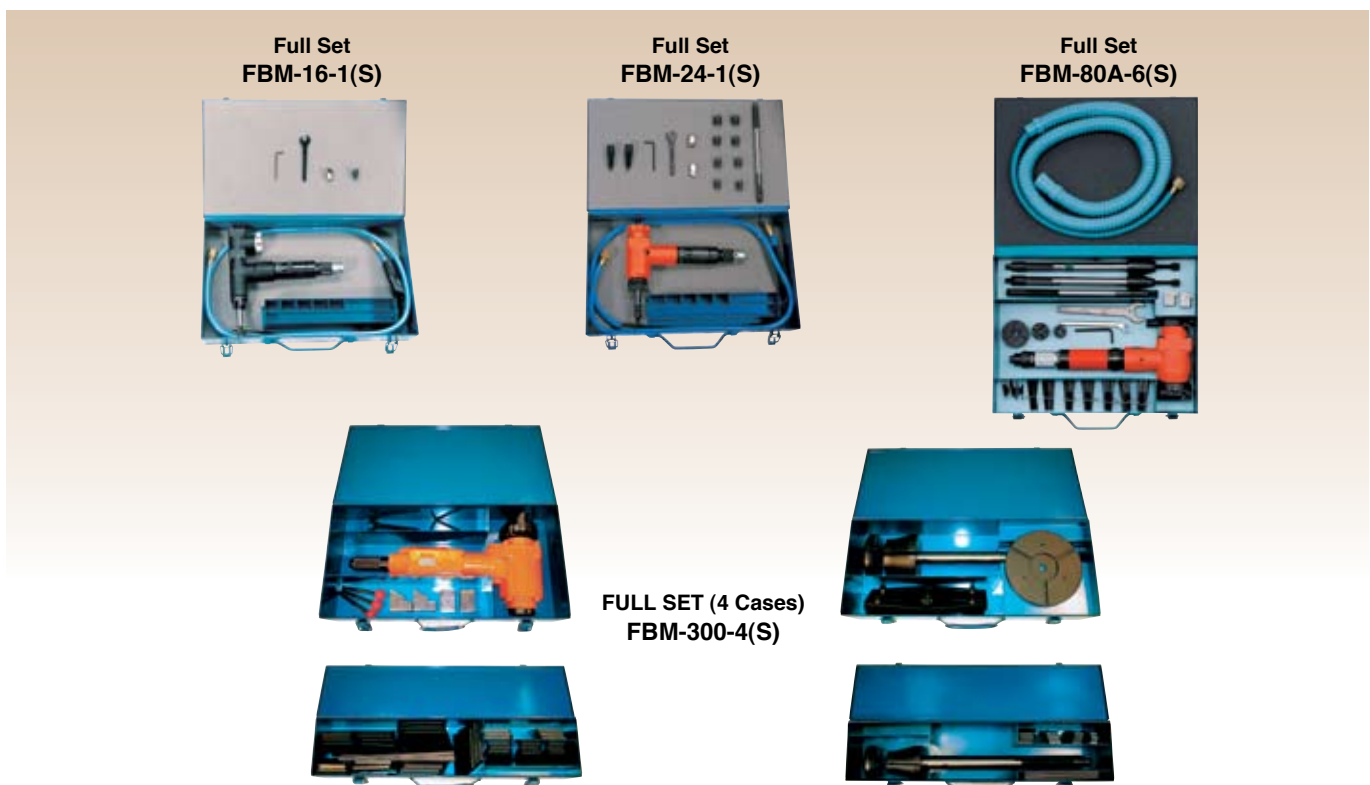

CHUCKS PROVIDED FOR FBM-16, 24, 80A AND 300

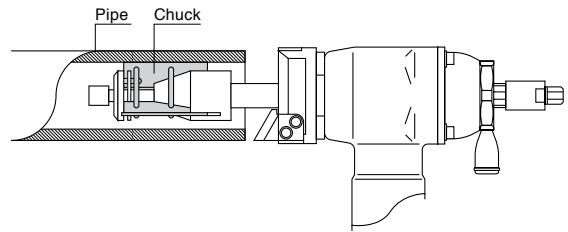
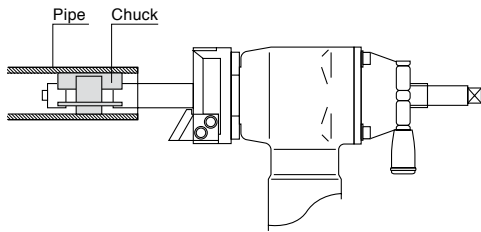

CHUCK TYPE



FBM-16-1
FBM-24-1
FBM-80A
(20mm~29mm)

CHUCK TYPE •



FBM-80A (30mm~80mm)
FBM-300 (240mm)
3pcs are necessary for each size

FOR FBM-16-1, -1S

Parts No.	Pipe Size
	mm
S-138638-00	12~14
S-138638-01	14~16
S-138638-03	18~20

FOR FBM-24-1, -1S

Parts No.	Pipe Size
	mm
S-120638-10	14~16
S-120638-11	16~18
S-120638-12	18~20
S-120638-13	20~22
S-120638-14	22~24

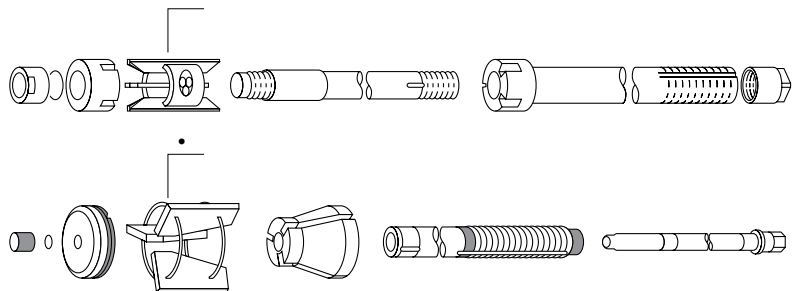

FOR FBM-80A •

Models	Parts No. (S-121638)			Parts No. (S-126238)						
	-00 20~23	-01 23~26	-02 26~29	-00 30~35	-01 35~40	-02 40~48	-03 48~56	-04 56~64	-05 64~72	-06 72~80
-2(30~40mm)	•	•	•	•	•	•	•	•	•	•
-3(40~80mm)	•	•	•	•	•	•	•	•	•	•
-4(30~80mm)	•	•	•	•	•	•	•	•	•	•
-5(20~29mm)	•	•	•	•	•	•	•	•	•	•
-6(20~80mm)	•	•	•	•	•	•	•	•	•	•



FOR FBM-300 •

Models	Parts No. (S-158638)															
	-00 80~90	-01 90~100	-02 100~110	-03 110~120	-04 120~130	-05 130~140	-06 140~150	-07 150~160	-08 160~170	-09 170~180	-10 180~190	-11 190~200	-12 200~210	-13 210~220	-14 220~230	-15 230~240
-2(80~120mm)	•	•	•	•	•	•	•	•	•	•	•	•	•	•	•	•
-3(120~240mm)	•	•	•	•	•	•	•	•	•	•	•	•	•	•	•	•

STANDARD BIT TOOLS

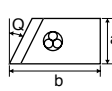
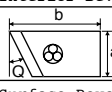
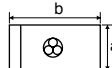
Bit Tool Shape	Parts No.	Angle	Dimensions (mm)			Models
		(Q)	a	b	Thickness	
For Exterior Beveling						
	BIT-016E01	30°	12	25	6	FBM-16
	BIT-024E01	30°	14	30	8	FBM-24
	BIT-042E02	37.5°	35	56	11.5	FBM-80A, 300
	BIT-042E03	45°	25	50	11.5	
	BIT-042E06	30°	25	40	11.5	FBM-300
	BIT-042E01	30°	35	50	11.5	
BIT-120E01	30°	60	60	11.5	FBM-80A, 300	
For Interior Beveling						
	BIT-024B06	30°	14	30	8	FBM-24
	BIT-042B01	30°	25	40	11.5	FBM-80A, 300
	BIT-042B02	45°	25	50	11.5	
For Surface Beveling						
	BIT-016F01	—	12	22	6	FBM-16
	BIT-024F01	—	14	25	8	FBM-24
	BIT-042F02	—	25	30	11.5	FBM-80A, 300
	BIT-120F01	—	60	40	11.5	FBM-300

*Bit Tools provided: **FBM-16:** BIT-016E01. **FBM-24:** BIT-024E01, 024F01.
FBM-80A: BIT-042E06, 042F02. **FBM-300:** BIT-120E01, 120F01.

*Other sizes of Bit Tool are available. Specify dimensions when ordering.

Metal Borer for Welding Beads Removing

Equipping metal borer and attachment, FBM-24-1 and 80A can be used for removing welding beads around tubes before pulling tubes out from tube sheet on heat exchangers and boilers.

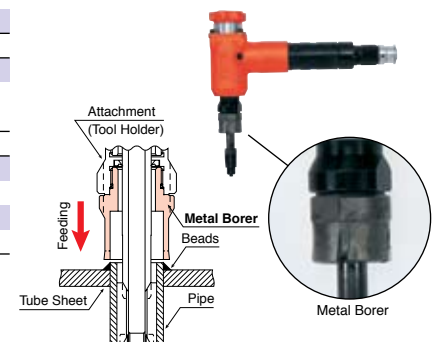

Automatic Seal Welders

AUTOMATIC SEAL WELDERS (TIG, CO₂/MAG)

Fuji Automatic Seal Welders assure ideal orbital welding of tubes and tube sheets of heat exchangers in either a vertical or horizontal position. This light weight unit features precise control, easy operation and a wide range of welding capacities. Four models are available for use with different types of welding heads.

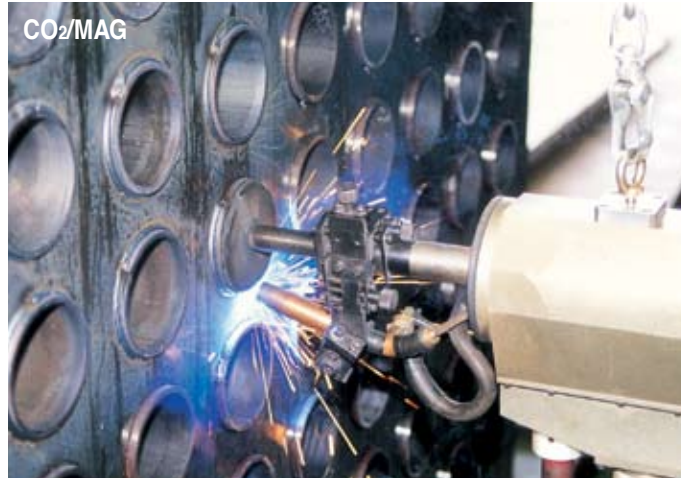

Features

Microcomputer Control for easy Programming

The operator is able to easily input the welding condition data in real figures directly to the Microcomputer Control.

Welding Program Storage

Up to 20 welding programs can be stored within the microcomputer for each TIG and CO₂/MAG welding. These programs can be recalled quickly and easily for the relevant application, saving time and improving productivity.

FUJI WELDING SYSTEM **FWS-1-1**

MONITOR SCREEN

CHANNEL : 01 DIVIDE : 01			
SEGMENT AUTO			
TUBE DIAMETER	006.0 mm	WIRE START TIME	1.2 Sec
WIRE DIAMETER	0.8 mm	WIRE STOP TIMING	0.5 Sec
LEG LENGTH	3.0 mm	PULSE START TIME	0.5 Sec
PULSE CURRENT	120 A	INITIAL CURRENT	050 A
BASE CURRENT	070 A	UP SLOPE	1.0 Sec
START POINT	000 DEGREES	FREQUENCY	04 Hz
TURNING START TIME	1.0 Sec	PULSE WIDTH	050 %
OVERLAP TIME	1.0 Sec		
CRATER MANGE TIME	1.0 Sec		

1: CHANNEL	3: ADJUSTMENT	5: DIVIDE	
2: SETUP	4: SYSTEM	6: INITIAL	

OPERATION

OFF ON

© FUJI AIR TOOLS CO., LTD.

Wide Welding Range

A wide range of orbital welding from small to large tube diameter can be performed without changing the welding head.

TIG

Standard

Min. 15.9mm~Max. 60mm

Option

Min. 6mm~Max. 150mm

CO₂/MAG

Standard

Min. 25mm~Max. 90mm

Option

Min. 15mm~Max. 150mm

High Quality welding with Delicate Halfway Welding Condition Adjustment

The welding condition can be set at any division to allow the welding to start at any point within the 360 degree circumference.

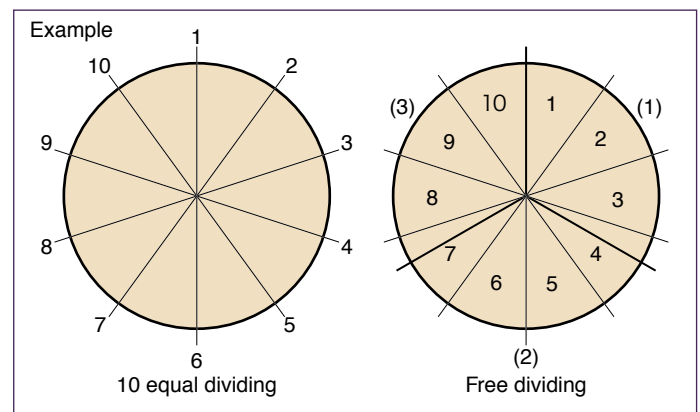

Stable Head Turning Speed and Wire Feeding Speed

Fuji Welders (TIG and CO₂/MAG) are equipped with a 'stepping' motor to precisely control the welding speed. A built-in Tachometer Generator on the TIG welder supervises and controls the wire feeding motor to maintain stable wire feeding speed.

Electrode Position Fixture

Regardless of the protruded tube length, the Electrode target position is fixed with this device.

Adjusting Knob

The position of the wire feeding nozzle can be easily adjusted forward and backward, and up and down by operating two Adjusting Knobs.

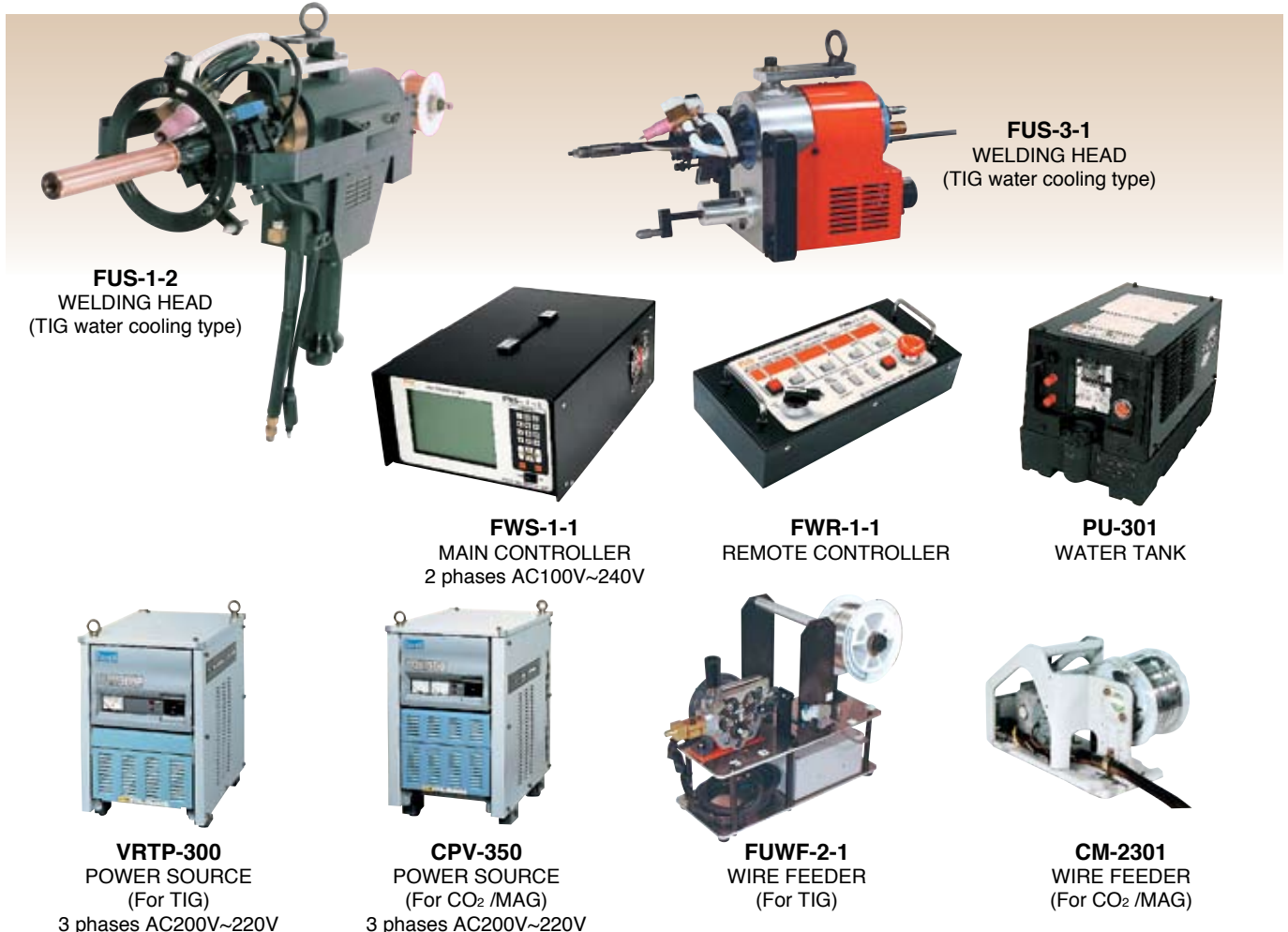
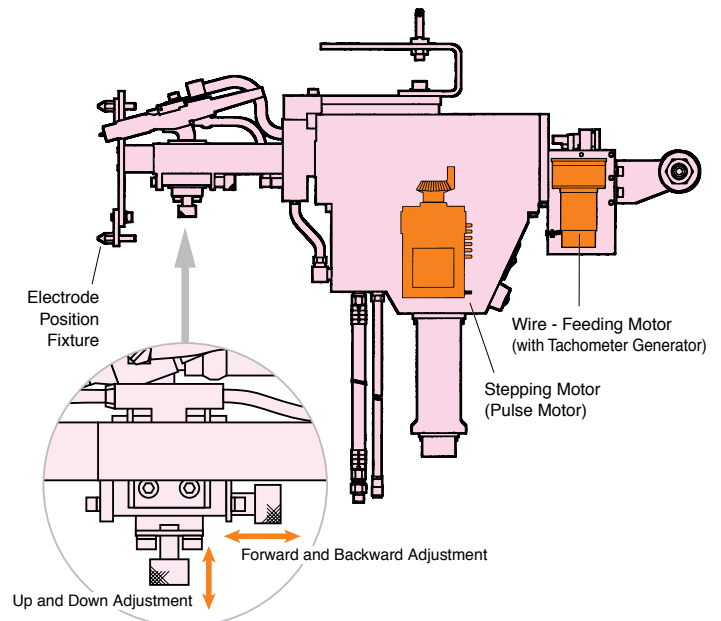

	Full Set	Welding Head	Applicable Tube Dia.	Water Tank	Main Controller	Remote Controller	Power Source	Wire Feeder
TIG	FUWS-1000-1T	FUS-1-1	15.9~60	-	FWS-1-1	FWR-1-1	VRTP-300	Equipped to Welding Head
	FUWS-1000-2T	FUS-1-2		PU-301	FWS-1-1S	FWR-1-1		FUWF-2-1
	FUWS-1000-3T	FUS-3-1	14~26	-	FWS-1-1	FWR-1-1		CM-2301
CO₂/MAG	FUWS-1000-1M	FUS-2-1	25~90	-	FWS-1-1	FWR-1-1	CPV-350	

	Standard Accessories					Option	
TIG	Pressure Gauge	Control Cable	Power Cable	Electrode Position Fixture	Tungsten 1 pc.	Expanding-Type Center Rod	Foot Switch
CO₂/MAG					-		

WELDING WIRE REWINDER

Fuji FUWS-2-1 is an ideal welding wire rewriter which can rewind steel and stainless steel wires from Max. 20kg wire drum to 2kg, 1kg or 500g wire reel. Quick rewinding time (app.3min. for 500g reel) with automatic stop mechanism reduces time consuming work.

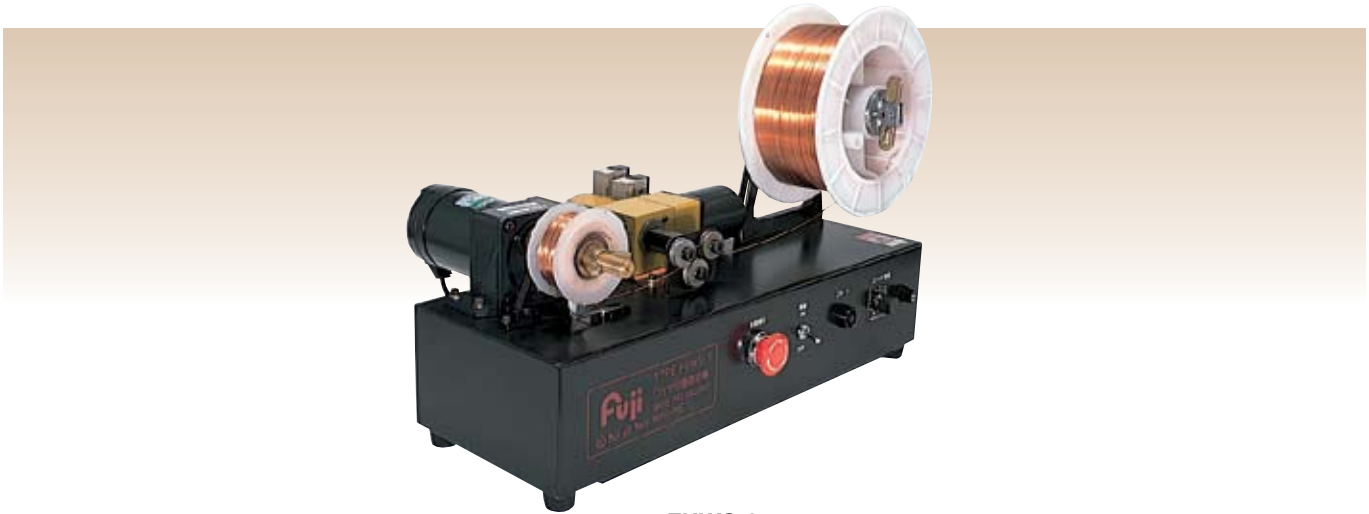

FUWS-2-1

Model	Dimensions			Mass		Power Source		Wire Drum Mounting Capacity	Windable Reel Size
	Width mm	Height mm	Depth mm	kg	lb	V	Hz	kg	
FUWS-2-1	2	630	379	22	44	AC100	50/60	20	ø120 (2kg)
	1								ø100 (1kg)
	0.5								ø80 (500g)

*Reel size can be changed by replacing spacer.

TUBE EXPANDERS

Tube Expanders are indispensable for tube expansion in production and repair of heat exchangers, coolers, etc. A wide range of Tube Expanders are prepared to meet various applications. The tube control device and other related auxiliary apparatus like tube pullers, tube cutters, facing tools and so forth are also available for effective, precise work.

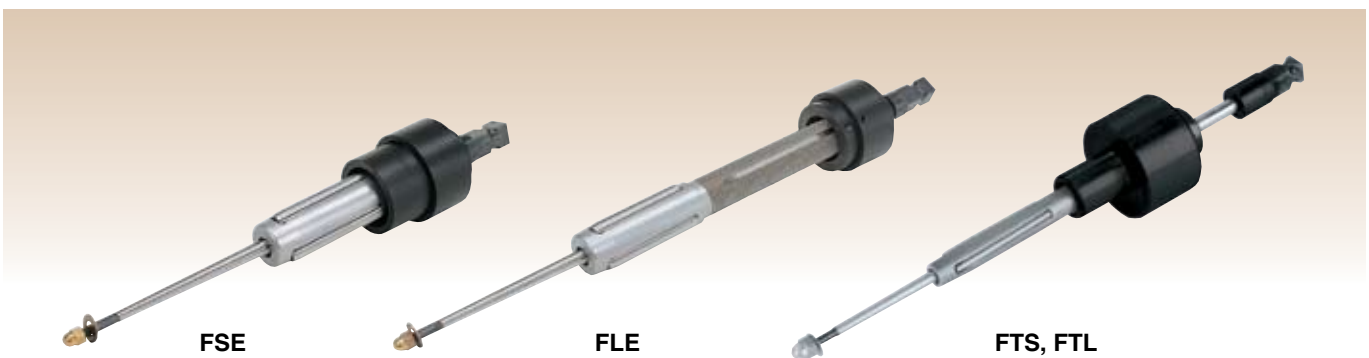

Type	Tube I/D	Roller Length			Tube Sheet Thickness	Use
	mm	mm	mm	mm		
FSE	8.3~105.8	38	57	76	<76mm	Condensers, Heat Exchangers Superheat
FLE	8.3~105.8	38	57	76	>75mm	Condensers, Heat Exchangers
FTS	4.6~9.0	19	32	-	<32mm	Oil Coolers, Air Coolers, Preheaters, Radiators
FTL	6.9~9.0	19	32	-	<32mm	Oil Coolers, Air Coolers, Preheaters, Radiators

*All above types have adjustable bearing collar to set expansion length.

*Five-roller, flaring-roller types are available on your request.

TIP DRESSERS

Fuji Tip Dresser FTD-18 series are designed to be compact, light weight and ideal for dressing tips in narrow space between opposing tips on electric spot welders. Patent applied FTD-18A clamp system provides excellent tip center alignment and accurate tip repairing. Various types of welding tips can be dressed by replacing cutter and cutter case.



Model	Capacity Tip Size		Max. Clamp Height		Rotational Frequency	Overall Length		Mass		Max. Air Consumption		Air Inlet Thread Size	Air Hose Size	
	mm	in	mm	in	min ⁻¹	mm	in	kg	lb	m ³ /min	ft ³ /min	in	mm	in
FTD-18-1	12~16	15/32~5/8	—	—	1,300	290	11 7/16	1.65	3.64	0.5	17.7	PT or NPT 1/4	9.5	3/8
FTD-18A-1	13~16	33/64~5/8	25	63/64	1,300	307	12 3/32	2.02	4.45	0.5	17.7	PT or NPT 1/4	9.5	3/8

CLASSIFICATION TABLE FOR CUTTERS

Type	Item No.	Tip shape (Nominal)	Max. diameter repaired(øD)	Standard
(1)	CUT-1001	6R	ø12	6R x ø12
	CUT-1002	6.5R	ø13	6.5R x ø13
	CUT-1003	8R	ø16	8R x ø16
(2)	CUT-2001	10R~150R	ø16	16R x ø16
(3)	—	øA x 6R	ø12	—
	—	øA x 6.5R	ø13	—
(4)	CUT-3001	øA x 8R	ø16	ø5 x 8R x ø16
	CUT-3002	øA x 8R	ø16	ø6 x 8R x ø16
(5)	—	5~6r x 60°	ø13	—
	—	3r or more x 90°	ø16	—
	—	7~ø9 x 50°	ø13	—
(6)	—	ø10 or more x 50°	ø16	—
	CUT-6001	5~ø7 x 60°	ø13	ø6 x 60° x ø13
	—	ø8 or more x 60°	ø16	—
	—	3~ø4 x 75°	ø13	—
(7)	CUT-6002	ø5 or more x 75°	ø16	ø6 x 75° x ø16
	CUT-6003	ø3 or more x 90°	ø16	ø4 x 90° x ø16
	CUT-6004	ø3 or more x 90°	ø16	ø6 x 90° x ø16
	—	ø3 or more x 120°	ø16	—
(8)	—	r x øA x θ°	øD	—
(9)	—	F	ø16	—

*Beside item listed above table, minimum 10pcs. per item is required for ordering optional cutters. Specify the nominal dimensions when ordering.
 *Cutter is not provided as a standard accessory.

SHAPES OF TIPS AND CUTTERS

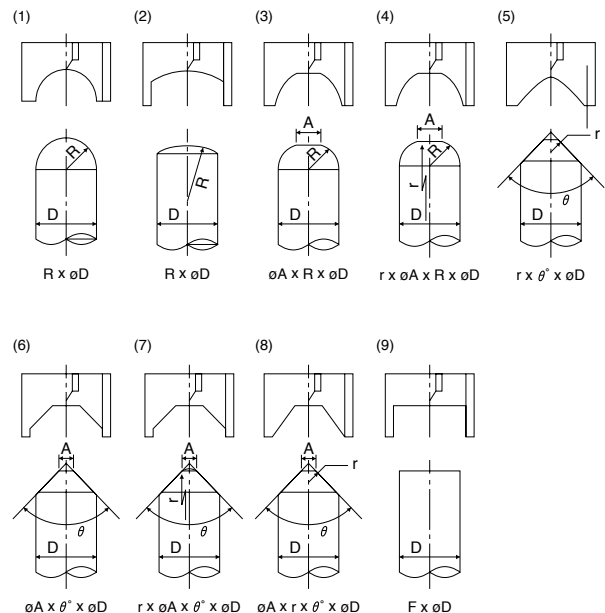

CUTTER CASES

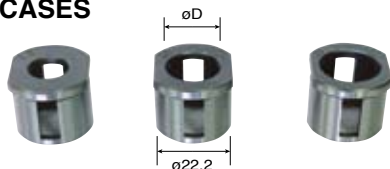

Item No.	øD
S-167716-00	16
S-167716-01	13
S-167716-02	12

*Cutter dresses Welding Tip correctly as inside diameter (øD) of cutter case act as a guide. Specify cutter case diameter which matches tip size. ø16 cutter case is included as a standard accessory. Specify cutter case diameter ø12 or ø13 otherwise.

<FTD-18A-1> PAT.P

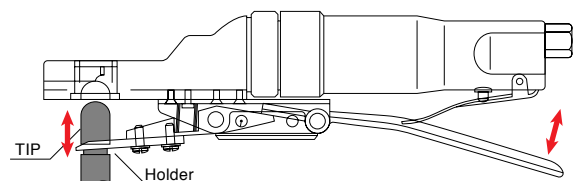

Chamfering Machines

CHAMFERING MACHINES

Fuji Chamfering Machines are compact and lightweight. They are ideal for chamfering edges of steel skeleton materials used in various industries such as bridge and steel frame construction, and ship building. Pneumatically driven with easily replaceable carbide tips (FX-027, FBM-1) and flap wheels (FX-018) provide uniform and precise chamfering.

PORTABLE MODELS

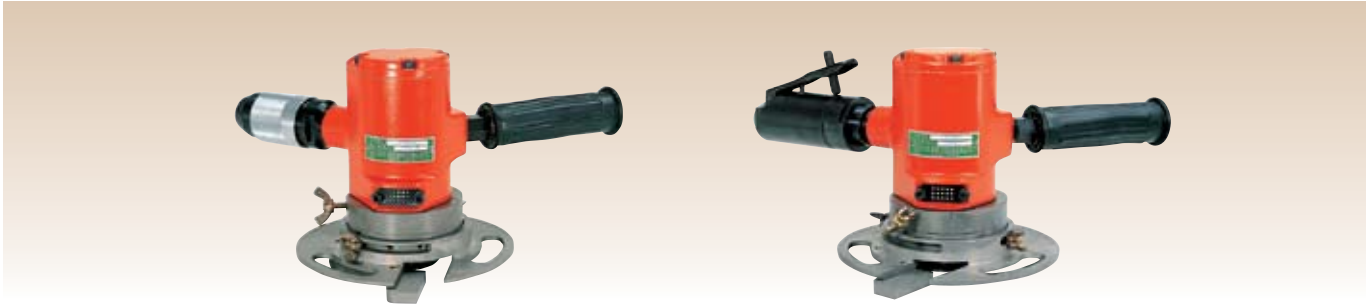

FBM-1-1, 2

FBM-1-1F, 2F

Model	Cutting Size	Torque	Max. Output	Rotational Frequency	Overall Length		Mass		Air Consumption (Free Speed)		Air Inlet Thread Size	Air Hose Size	
	mm	N · m	kW	min ⁻¹	mm	in	kg	lb	m ³ /min	ft ³ /min	in	mm	in
Roll Handle Type													
FBM-1-1	R3,R2,R1	3.2	0.48	5,700	144	5 43/64	3.7	8.1	1.0	35.3	PT or NPT 3/8	9.5	3/8
FBM-1-2	C2,C1	3.2	0.48	5,700	144	5 43/64	3.7	8.1	1.0	35.3	PT or NPT 3/8	9.5	3/8
Locking Lever Handle Type													
FBM-1-1F	R3,R2,R1	3.2	0.48	5,700	144	5 43/64	3.8	8.4	1.0	35.3	PT or NPT 3/8	9.5	3/8
FBM-1-2F	C2,C1	3.2	0.48	5,700	144	5 43/64	3.8	8.4	1.0	35.3	PT or NPT 3/8	9.5	3/8

SELF-PROPELLED MODELS

Fuji FX-027-1 and FX-018-2F are self-propelled chamfering machines used to chamfer both edges of steel skeleton structures simultaneously. Clamping is automatic and the clamping force can be easily adjusted. They are able to run both forwards and backwards and stop automatically at the end of the work piece.

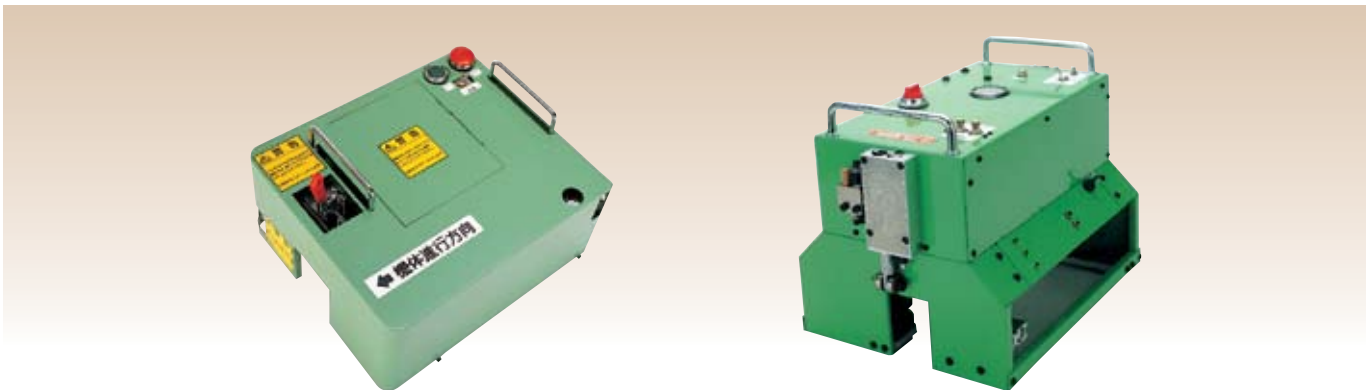

FX-027-1

FX-018-2F

Model	Chamfering Thickness	Size W x H x D	Min. Chamfering Height	Propelling Speed	Chamfering Amount (Guidance)		Mass		Air Consumption (Free Speed)		Air Hose Size	
	mm	mm	mm	m/min	R	(C)	kg	lb	m ³ /min	ft ³ /min	mm	in
FX-027-1	9~50	388 x 223 x 335	100	0.8	1~3	(1~3)	22.0	48.4	1.4	49.4	19.0	3/4
FX-018-2F	6~30 or 20~45	430 x 306.5 x 291	80	2~4	—	1~2	19.5	42.9	1.2	42.4	12.7	1/2

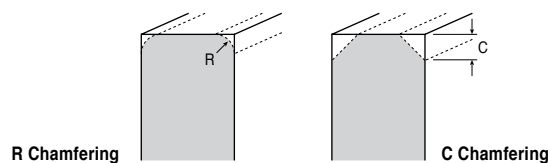

To change chamfering size, bracket and adjusting spacer for the FX-027-1 and the guide roller for FBM-1 series it is necessary change together with the cutters.

CUTTERS FOR FBM-1 SERIES, FX-027-1



R Type

AC No.	Quantity Required	Size
X-027-11	3	R1
X-027-10	3	R2
X-025-003	3	R3



C Type

AC No.	Quantity Required	Size
X-027-13	3	C1 or C2

GUIDE ROLLER FOR FBM-1 SERIES

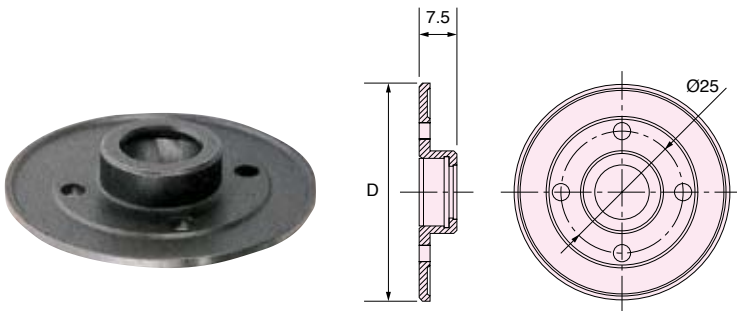

Parts No.	Quantity Required	Size	D(mm)
S-173698-02	1	R1, C1	44.6
S-173698-01	1	R2, C2	43.8
S-173698-00	1	R3	42.8

ATTACHMENT FOR FX-027-1

Parts No.	Quantity Required	Name	Size	D(mm)	t(mm)
X-027X81-00	2	Bracket	R1, C1	2.8	14.2
X-027X83-00	1	Adjusting Spacer	R1, C1	-	8.2
X-027X80-00	2	Bracket	R2, C2	2.3	14.7
X-027X82-00	1	Adjusting Spacer	R2, C2	-	7.0
X-027X78-00	1	Bracket	R3	-	-
X-027X79-00	1	Adjusting Spacer	R3	-	6.0

ADJUSTING SPACER

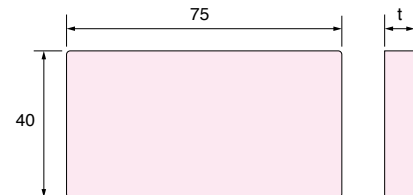

BRACKET R1, R2

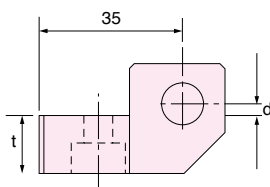

BRACKET R3

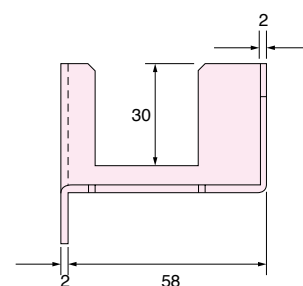
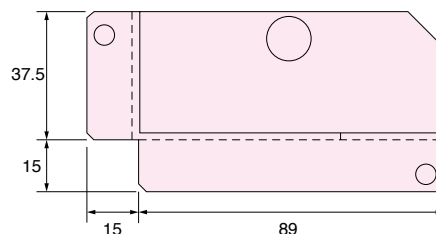

Aluminum Milling Machines

ALUMINUM MILLING MACHINES

Aluminum Milling Machines are ideal portable tools to remove weld beads flush to the work surface and "V" grooving for aluminum welds with milling type rotary cutters. The high power motor supplied with speed control governor provides smooth milling. The tools feature easy depth adjustments, chip blowing, milling cutter cooling, slow start throttle, and center guide with guide roller for easy operation.



FRC-200-1

FRC-300-1

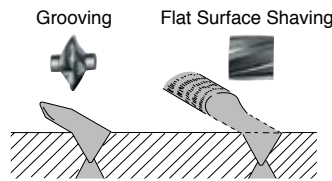
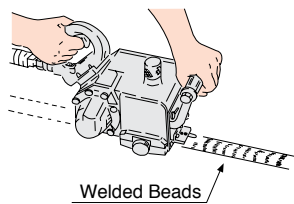

Model	Max. Grooving Depth	Max. Cutter Width	Cutter Shaft Dia.	Horse Power		Rotational Frequency	Overall Length		Mass		Max. Air Consumption		Air Inlet Thread Size	Air Hose Size	
	mm	mm	mm	kW	PS	min ⁻¹	mm	in	kg	lb	m ³ /min	ft ³ /min	PT or NPT	mm	in
FRC-200-1	15.5	50	12	1.25	1.7	7,000	295	11 39/64	4.7	10.3	1.4	49.4	3/8	12.7	1/2
FRC-300-1	30.0	50	15	2.65	3.6	4,600	372	14 41/64	14.0	30.8	2.2	77.7	3/8	19.0	3/4

CUTTERS FOR FRC-200, 300 SERIES

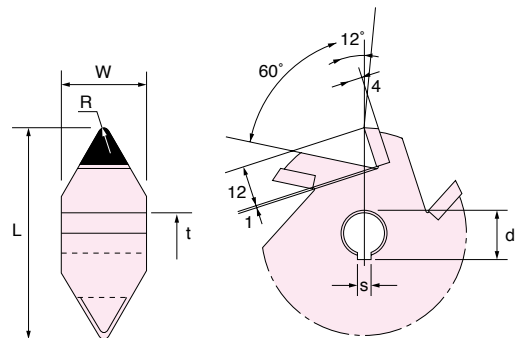
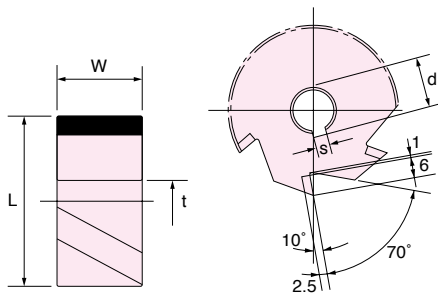

Flat Surface Shaving Cutter

AC No.	Size(mm)					Models
	L	W	t	d	s	
CUT-0205	50	25	12 ϕ	13.7	4	FRC-200-1
CUT-0204	60	51	15 ϕ	17.3	5	FRC-300-1

Grooving Cutter

AC No.	Size(mm)						Models
	L	R	W	t	d	s	
CUT-0202	62	3	25	12 ϕ	13.7	4	FRC-200-1
CUT-0208	100	4	42	15 ϕ	17.3	5	FRC-300-1

AIR FILES / AIR SAWS

Fuji FRF series compact Air File & Saws feature reduced vibration and are designed for deburring, filing and cutting of metal, wood, plastic, and fibreglass.

The FRS-45 Air Saw is equipped with a damper to minimize vibration and, a stroke regulator and blade cooling device. The cutting direction is adjustable to provide optimal operator comfort.

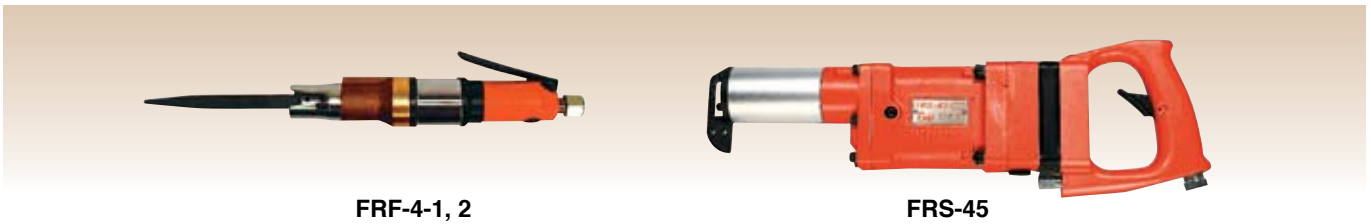

Model	Tool Name	Stroke Per Minute SPM	Stroke		Chuck Capacity		Overall Length		Mass		Max. Air Consumption		Air Inlet Thread Size	Air Hose Size	
			mm	in	mm	in	mm	in	kg	lb	m ³ /min	ft ³ /min		PT or NPT	mm
FRF-4-1	File	1,600	12.0	15/32	4.0 x 13.0 x 20	5/32 x 1/2 x 25/32	229	9 1/32	0.8	1.7	0.28	9.9	1/4	6.3	1/4
FRF-4-1F	File	1,600	12.0	15/32	4.0 x 13.0 x 20	5/32 x 1/2 x 25/32	229	9 1/32	0.8	1.7	0.28	9.9	1/4	6.3	1/4
FRF-4-2	Saw	1,600	12.0	15/32	2.0 x 13.0 x 20	5/64 x 1/2 x 25/32	233	9 3/16	0.8	1.7	0.28	9.9	1/4	6.3	1/4
FRF-4-2F	Saw	1,600	12.0	15/32	2.0 x 13.0 x 20	5/64 x 1/2 x 25/32	233	9 3/16	0.8	1.7	0.28	9.9	1/4	6.3	1/4
FRS-45	Saw	1,200	45.0	1 25/32	2.5 x 17.7 x 31	3/32 x 45/64 x 1 7/32	419	16 1/2	2.9	6.3	0.40	14.1	1/4	9.5	3/8

*Models marked 1F, 2F are locking lever handle types.

FILE BLADES FOR FRF-4-1, 1F

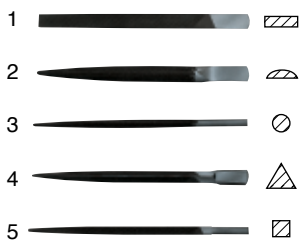

Index No.	AC No.	Name	Overall Length
1	•FILE-4P	Pillar	150
2	FILE-4H	Half Round	
3	FILE-4R	Round	
4	FILE-4C	Triangle	
5	FILE-4S	Square	

** =Accessories included in FRF-4-1, 1F

SAW BLADE FOR FRF-4-2, 2F

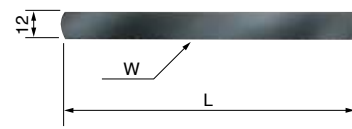

AC No.	Size	
	L	W
•SAW-4	123	25

** =Accessories included in FRF-4-2, 2F.
W =The number of teeth per inch.

SAW BLADES FOR FRS-45

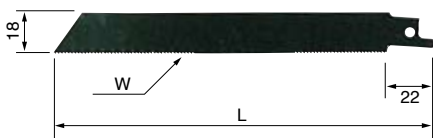

AC No.	Size		Cutting Materials
	L	W	
SAW-2014	200	14	steel plate, pipe, copper, brass, plastic, slate
•SAW-2018	200	18	steel plate, pipe
•SAW-2024	200	24	steel plate, pipe
SAW-2514	250	14	steel plate, pipe, copper, brass, plastic, slate
SAW-2518	250	18	steel plate, pipe
SAW-3014	300	14	steel plate, pipe, copper, brass, plastic, slate
SAW-3018	300	18	steel plate, pipe

** =Accessories included in FRS-45. W =The number of teeth per inch.

*Using cutting fluid extends life of blade. A mixture of turpentine and kerosene with spindle oil, soapsuds, grease at the rate of 7 to 3 is recommended.

Standard Accessories for FRS-45



SAW-2018	Saw Blade	1
SAW-2024	Saw Blade	1
F-704	4mm Hex. Pin Wrench	1
F-706	6mm Hex. Pin Wrench	1
AO-30	Oil	1
CASE-T431	Steel Case	1

Sump Pumps/Piston Pumps

SUMP PUMPS

Fuji Sump Pumps are indispensable for discharging water, oil, sewage and sludge from sumps, trenches, manholes, bilges and tanks. They may be used in non-spark environments and their housings are rust-proof.

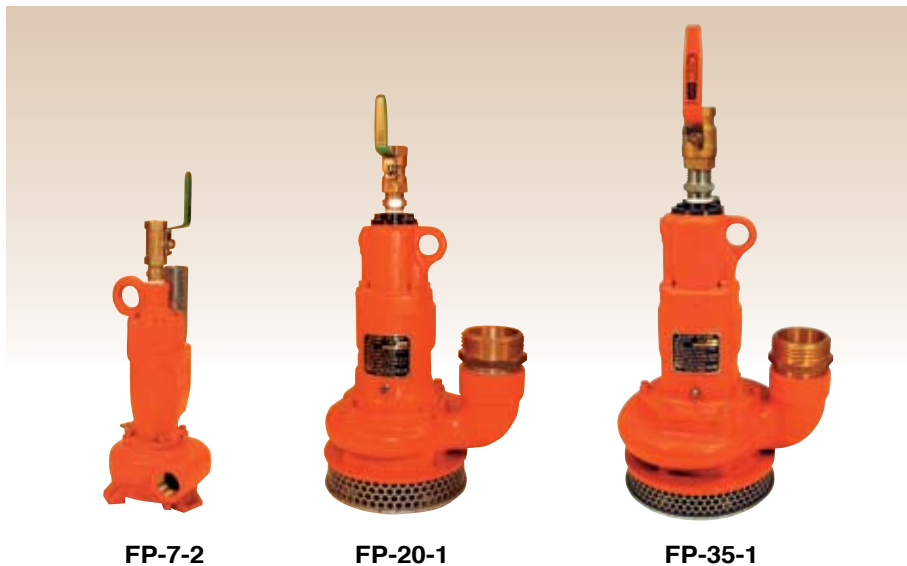

Pumping Performance Curve

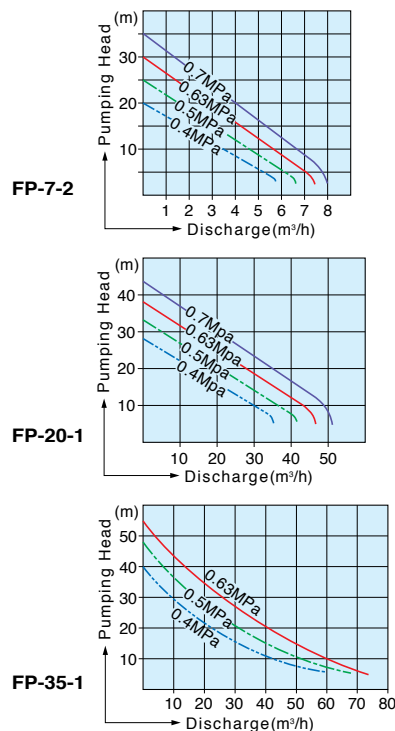

Model	Capacity				Water Output Thread Size	Air Outlet Thread Size	Height		Mass		Max. Air Consumption		Air Inlet Thread Size	Air Hose Size		
	Head		Discharge				mm	in	kg	lb	m³/min	ft³/min		PT or NPT	mm	in
	m	ft	m³/h	g/min												
FP-7-2	15	49	4.2	70	PT3/4	3/4	234	9 1/4	4.3	9.4	0.80	28.2	3/8	9.5	3/8	
FP-20-1	20	66	28.0	467	W82.5-5	1	374	14 3/4	22.0	48.4	3.40	120.1	3/4	19.0	3/4	
FP-35-1	28	92	28.0	467	W82.5-5	1 1/4	410	16 9/64	34.0	74.8	5.20	183.6	1	25.4	1	

PISTON PUMPS

Fuji Piston Pumps FP-11 series are ideal pumps for pumping oil out from tanks and bilges in the vessels. Various flanges are optionally available for hose connection.

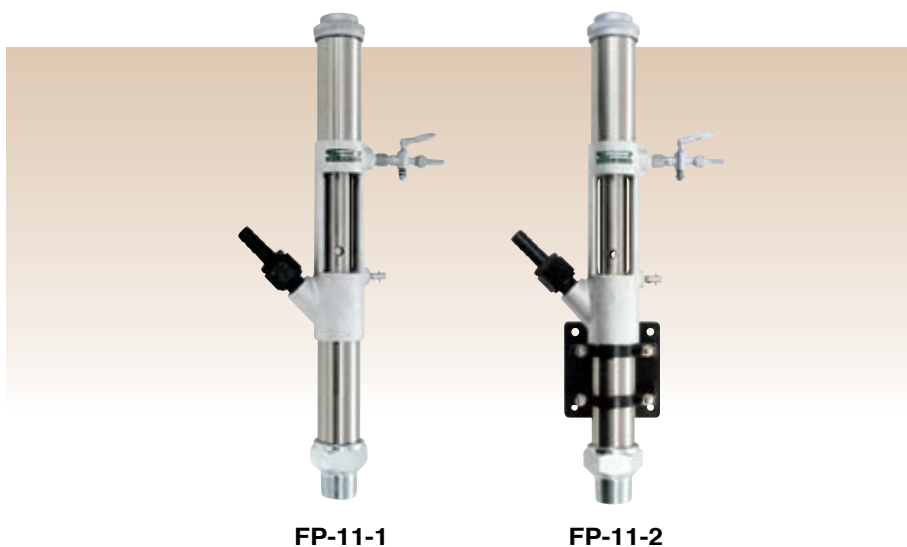

Pumping Performance Curve

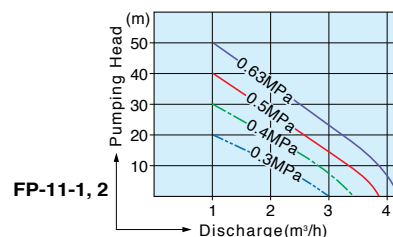

Model	Discharge Volume	Piston Diameter		Stroke		Stroke No.	Overall Length		Mass		Max. Air Consumption		Air Inlet Thread Size	Air Hose Size	
		mm	in	mm	in		mm	in	kg	lb	m³/min	ft³/min		PT or NPT	mm
FP-11-1	4.2	48	1 57/64	100	3 15/16	4	622	24 31/64	4.7	10.3	0.20	7.1	1/4	9.5	3/8
FP-11-2	4.2	48	1 57/64	100	3 15/16	4	622	24 31/64	7.8	17.2	0.20	7.1	1/4	9.5	3/8

*Testing Oil ... ISO VG32Oil

MARKING PEN

Fuji Marking Pen features a lower vibration level when compared to conventional marking pens enabling operators to use this tool for a full days work. This tool also requires no lubrication and meets requirements where oil free operation is specified.



G-400

Model	Diameter		Overall Length		Mass		Air Consumption (at Load)	
	mm	in	mm	in	kg	lb	m ³ /min	ft ³ /min
G-400	20	25/32	140	5 1/2	0.15	0.33	0.03	1.1

DEBURRING TOOLS

Fuji FDH series are ideal air hammers for knockout machines which are designed for removing sand from engine cylinder block castings. The chisels can be positioned easily and the original chisel bush guarantees run-out free performance. A built in shock absorber not only reduces the risk of chisel breakage and lightens the impact load to the cylinder block, but it also delivers the chisel blow to the pre-set position without 'chatter'.



FDH Series

Knockout Machine for removing sand from cylinder block

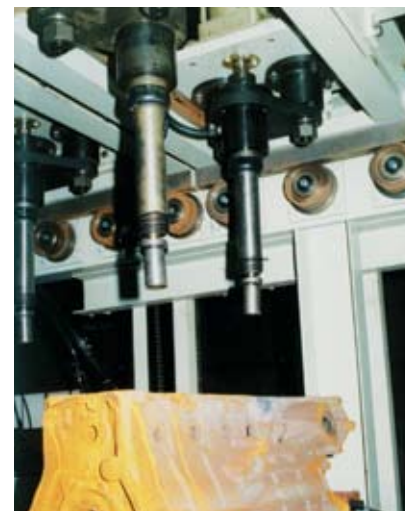

Air Line Heaters/Air Cleaners

AIR LINE HEATERS

Fuji Air Line Heaters are portable, durable and simple to use. Their use prevents freezing and eliminates the cold feeling while the operator uses air tools for an extended period of time.

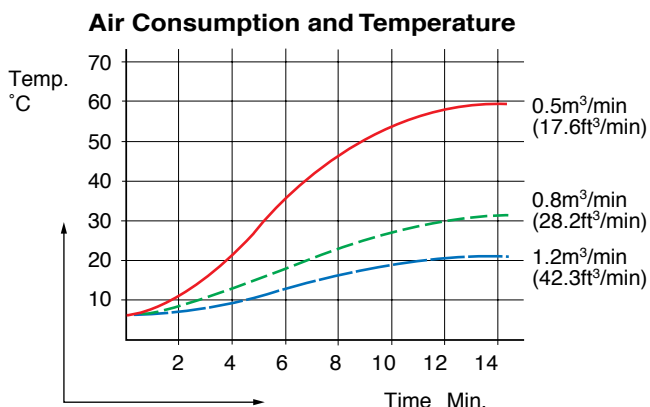
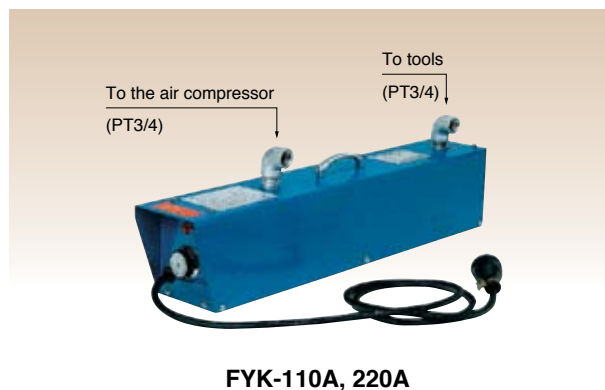

Model	Power Source		Power Consumption	Dimensions(Width x Height x Length)		Mass	
	V	Hz		mm	in	kg	lb
FYK-110A	2 phases AC100	50/60	1.0	125 x 150 x 750	5 x 6 x 29	13.0	28.6
	2 phases AC110		1.2				
FYK-220A	3 phases AC200		1.0				
	3 phases AC220		1.2				

AIR CLEANERS

Fuji Air Cleaners remove dust, chips, sawdust, water and oil with their powerful vacuum action.

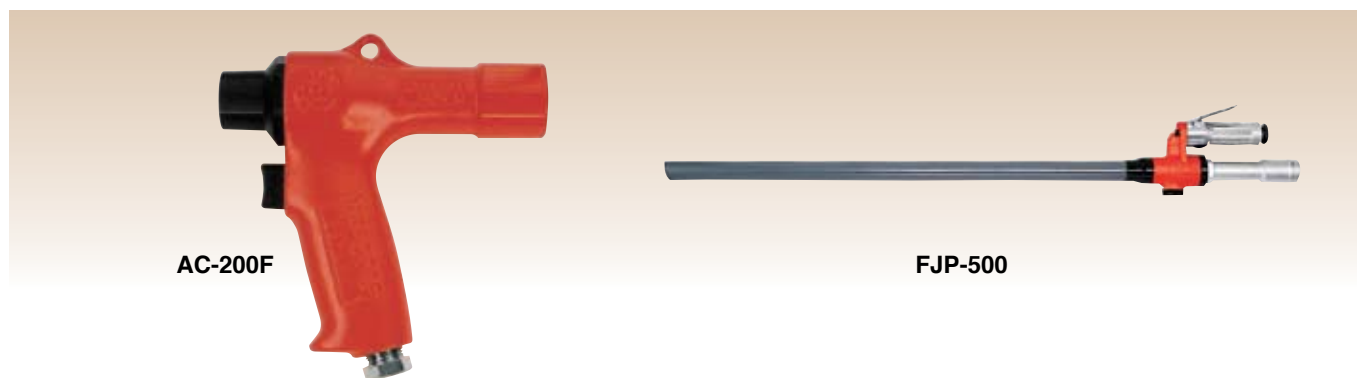

Model	Vacuum Degree		Overall Length		Outside Dia. of Discharge	Mass		Max. Air Consumption		Air Inlet Thread Size	Air Hose Size	
	mm Hg	in Hg	mm	in		kg	lb	m³/min	ft³/min		mm	in
AC-200F	130	5 1/8	145	5 45/64	34	0.5	1.1	0.60	21.2	1/4	9.5	3/8
FJP-500	200	7 7/8	1020	40 5/32	37.5	1.5	3.3	1.10	38.8	3/8	9.5	3/8

Accessories Provided for AC-200F



Index No.	AC No.	Name
1	ACB-1F	Main Nozzle
2	ACB-2F	Fan Shape Nozzle
3	ACB-3F	Small-Size End Nozzle
4	ACB-4F	Flexible Hose
5	ACB-5F	Rubber Joint
6	ACB-6F	Dust Bag
7	ACB-7F	Hose Band

AIR HOISTS (Link Chain Type)

Fuji Link Chain Type Air Hoists are featured with variable speed control, latest technology multi vane air motor design, effective and durable drum brake, upper and lower limit switch mechanism and high manoeuvrability. Two types of control, pull cord and pendant, are available. Models equipped with emergency stop button and overload protector, for safer operation, are available on request.



FAH-25LC, 50LC

FAH-25LP, 50LP

FAH-100LC

FAH-100LP

Model	Control	Air Pressure		Lifting Speed	Lifting Capacity		Lift		Mass		Max. Air Consumption	Inlet
		MPa	kg/cm ²	m/min	kN	kgf	m	ft	kg	lb	m ³ /min	PT or NPT
Single Chain Type												
FAH-25LC	Pull Cord	0.6	6.0	17.0	2.5	250	3	9.8	21	46.2	1.6	1/2
FAH-25LP	Pendant	0.5	5.0	15.0					23	50.6	1.3	
FAH-50LC	Pull Cord	0.6	6.0	12.0	5.0	500	3	9.8	21	46.2	1.6	1/2
FAH-50LP	Pendant	0.5	5.0	10.0					23	50.6	1.3	
FAH-50LP	Pendant	0.4	4.0	7.0					23	50.6	1.0	
Double Chain Type												
FAH-100LC	Pull Cord	0.6	6.0	6.0	10.0	1,000	3	9.8	26	57.2	1.6	1/2
FAH-100LP	Pendant	0.5	5.0	5.0					28	61.6	1.3	
FAH-100LP	Pendant	0.4	4.0	3.5					28	61.6	1.0	

OPTIONAL ACCESSORIES



Chain Bucket

In addition to the standard Chain Bucket used for standard lifting, chain buckets with different capacities are available to provide an increased length of lifting if required.



Exhaust Air Cleaner

The Exhaust Air Cleaner is utilised to eliminate oil mist from the exhaust air. Please contact us if required.

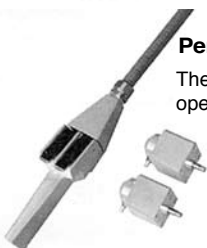

Pendant Control KIT

The pull cord actuation can be changed to Pendant operation by fitting the Pendant Control Kit.



4-Button Pendant Control

The 4-Button Pendant control is used with the Air Motor-driven Hoist.

Trolleys

Please select suitable trolley depending on application.

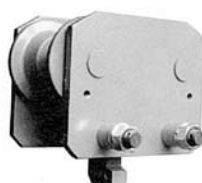

Plain Trolley



Geared Trolley



Air Motor-driven Trolley

Air Winches

AIR WINCHES

Fuji Air Winches are powerful, durable and offer long service life. They are ideal for heavy-duty applications in mining, construction, shipping and heavy machine industry. Remote control and automatic brakes are available as options.

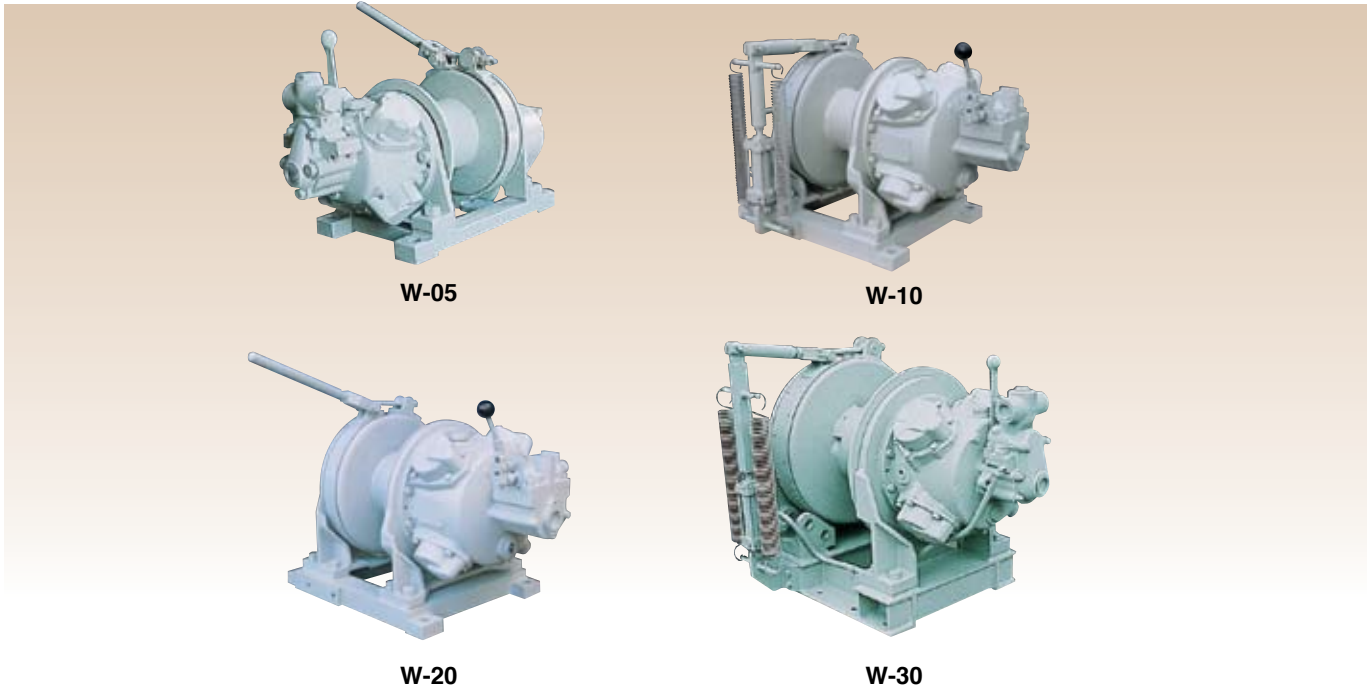

Model	Motor Output kW	Rope Pull kN	Rope Speed m/min	Max. Air Consumption m ³ /min	Drum Capacity mm x m	Mass	
						Manual Brake kg	Automatic Brake kg
W-05-3-S	1.73	5	19	2.0	8 x 45	55	59
W-05-3-L	1.73	5	19	2.0	8 x 90	60	64
W-10-220-S	7.15	10	37	5.4	10 x 175 12.5 x 115	257	267
W-10-220-L	7.15	10	37	5.4	10 x 350 12.5 x 230	276	288
W-20-220-S	7.15	20	19	5.4	12.5 x 115	266	276
W-20-220-L	7.15	20	19	5.4	12.5 x 230	287	297
W-30-36-S	12.00	30	19	9.0	16 x 160	470	484
W-30-36-L	12.00	30	19	9.0	16 x 320	513	527
W-50-36-S	12.00	50	11	9.0	22.4 x 115	-	780
W-50-36-L	12.00	50	11	9.0	22.4 x 230	-	873

Model	Drum Size			Rope anchor hole Dia. mm
	Dia. mm	Root Dia. mm	Width mm	
W-05-3-S	120	216	114	10
W-05-3-L	120	216	228	10
W-10-220-S	180	410	178	16
W-10-220-L	180	410	356	16
W-20-220-S	180	410	178	16
W-20-220-L	180	410	356	16
W-30-36-S	240	530	240	20
W-30-36-L	240	530	480	20
W-50-36-S	330	600	300	28
W-50-36-L	330	600	600	28

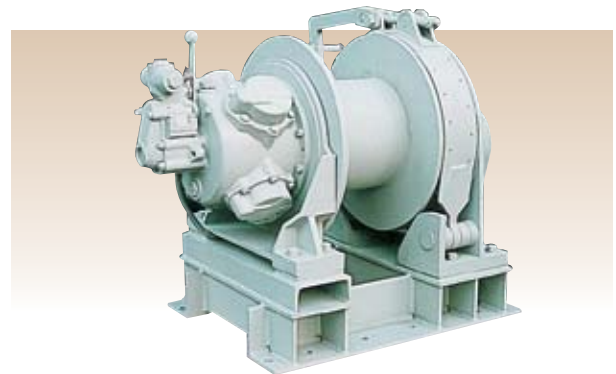

W-50

Air Line Accessories Spanners and Wrenches for Maintenance

AIR LINE ACCESSORIES	112
SPANNERS AND WRENCHES FOR MAINTENANCE	116
AIR TOOLS AND AIR COMPRESSOR	117
AIR TOOLS AND AIR PRESSURE	117

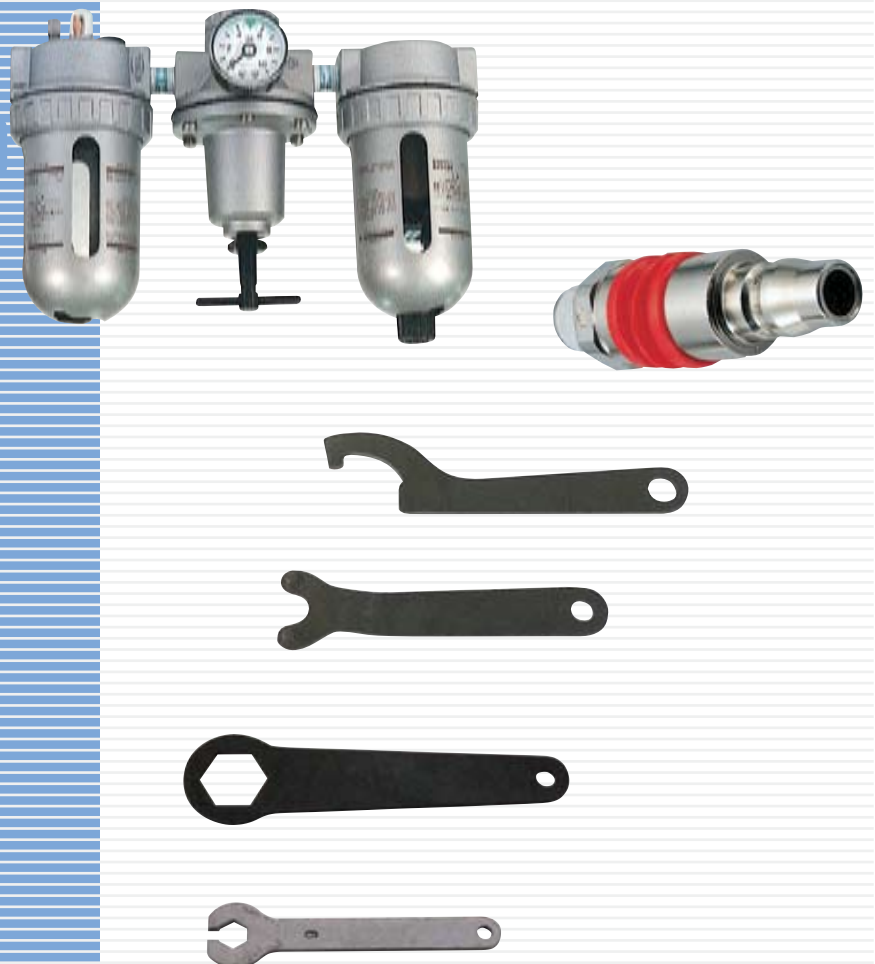

Air Line Accessories

AIR FILTERS

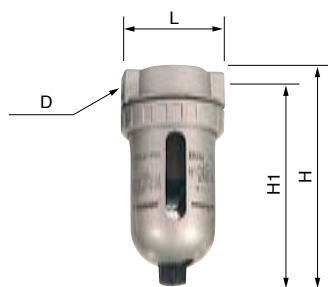

AC No.	Maximum Flow Rate m ³ /min	Size			
		D	L	H	H ₁
AF2000	0.75	1/8, 1/4	40	97.5	86.5
AF3000	1.50	1/4, 3/8	53	132.5	118.5
AF4000	4.00	1/4, 3/8, 1/2	70	168.5	150.5
AF4000-06	6.00	3/4	75	172.5	152.5
AF5000	7.00	3/4, 1	90	247.5	223.5
AF6000	8.00	1	95	261.5	237.5

*The above maximum flow rate is on the air pressure of 7kg/cm² and the pressure drop is 0.2kg/cm². The maximum allowable air pressure is 9.9kg/cm².
*Specify D (thread size) when ordering.

AIR REGULATORS

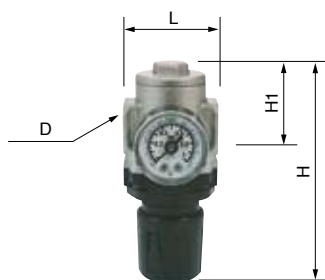

AC No.	Maximum Flow Rate m ³ /min	Size			
		D	L	H	H ₁
AR2000	0.55	1/8, 1/4	40	95.0	17.0
AR2500	2.00	1/4, 3/8	53	102.5	25.0
AR3000	2.50	1/4, 3/8	53	127.5	35.0
AR4000	6.00	1/4, 3/8, 1/2	70	149.5	37.5
AR4000-06	6.00	3/4	75	154.5	40.5
AR5000	8.00	3/4, 1	90	168.0	48.0
AR6000	10.00	1	95	204.5	48.0

AIR OILERS

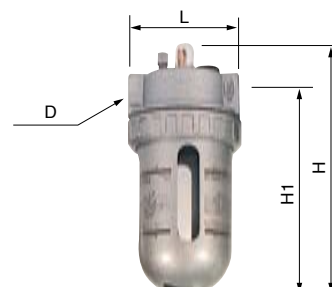

AC No.	Maximum Flow Rate m ³ /min	Size			
		D	L	H	H ₁
AL2000	0.80	1/8, 1/4	40	122	84
AL3000	1.70	1/4, 3/8	53	142	104
AL4000	5.00	1/4, 3/8, 1/2	70	177	136
AL4000-06	6.30	3/4	75	177	138
AL5000	7.00	3/4, 1	90	254	209
AL6000	7.50	1	95	268	223

AIR LINE SET (OILER · REGULATOR · FILTER)

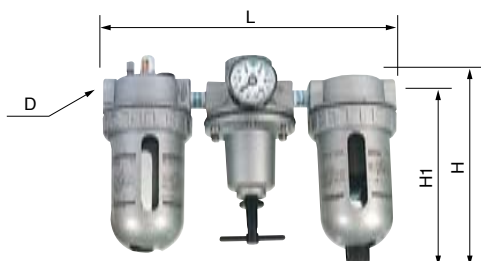

AC No.	Maximum Flow Rate m ³ /min	Size			
		D	L	H	H ₁
AC2000	0.50	1/8, 1/4	140	124.5	86.5
AC2500	1.50	1/4, 3/8	181	156.5	118.5
AC3000	2.00	1/4, 3/8	181	156.5	118.5
AC4000	4.00	1/4, 3/8, 1/2	238	191.5	150.5
AC4000-06	4.50	3/4	253	193.0	152.5
AC5000	5.00	3/4, 1	300	271.5	223.5
AC6000	7.00	1	315	285.5	237.5

*Specify D (thread size) when ordering.

MINI OILERS

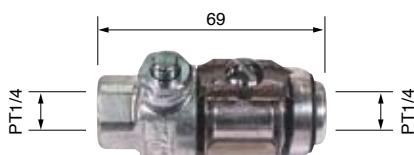

AC No.	MO-02
--------	-------

AIR REGULATORS



AC No.	Size		
	D	d	L
W-10	1/8	1/8	42
W-17	1/4	1/4	42
W-30	1	1	108



AC No.	Size	
	D	L
W-65P	1/4	48

INLET BUSHINGS

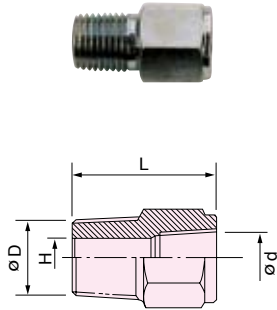

PT x PT Thread

Parts No.	Size			
	D	d	L	H
	PT	PT	mm	mm
IB-1010S0	1/8	1/8	25	5.0
IB-102000	1/8	1/4	25	5.0
IB-2010S0	1/4	1/8	15	6.0
IB-201000	1/4	1/8	15	7.0
IB-2020S0	1/4	1/4	28	6.5
IB-202000	1/4	1/4	30	7.0
IB-202001	1/4	1/4	30	4.5
IB-203000	1/4	3/8	32	6.5
IB-203001	1/4	3/8	39	3.5
IB-203002	1/4	3/8	36	4.0
IB-3020S0	3/8	1/4	23	10.5
IB-302000	3/8	1/4	30	9.0
IB-302001	3/8	1/4	32	6.0
IB-303000	3/8	3/8	36	9.0
IB-304000	3/8	1/2	42	9.0
IB-4030S0	1/2	3/8	27	12.0
IB-403000	1/2	3/8	36	12.0
IB-4040S0	1/2	1/2	44	12.0
IB-404000	1/2	1/2	42	12.0
IB-406000	1/2	3/4	44	12.0
IB-806000	1	3/4	32	19.0

PT x NPT Thread

Parts No.	Size			
	D	d	L	H
	PT	NPT	mm	mm
IB-201N00	1/4	1/8	18	7.0
IB-202NS0	1/4	1/4	29	6.5
IB-202N00	1/4	1/4	30	7.0
IB-202N01	1/4	1/4	30	4.5
IB-302NS0	3/8	1/4	23	10.5
IB-303N01	3/8	3/8	36	6.0
IB-403NS0	1/2	3/8	27	12.0
IB-404N00	1/2	1/2	42	12.0

NPT x NPT Thread

Parts No.	Size			
	D	d	L	H
	NPT	NPT	mm	mm
IB-6N3NS0	3/4	3/8	27	14.5
IB-6N4NS0	3/4	1/2	31	16.0

NPT x PT Thread

Parts No.	Size			
	D	d	L	H
	NPT	PT	mm	mm
IB-6N30S0	3/4	3/8	27	14.5
IB-6N40S0	3/4	1/2	31	16.0

HOSE NIPPLES

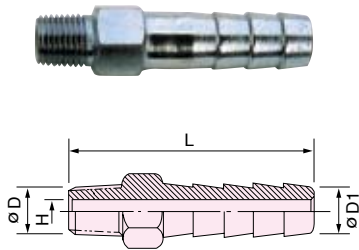

PT Thread

Parts No.	Size				Hose Size	
	D	D ₁	L	H	mm	in
	PT	mm	mm	mm	mm	in
HN-101500	1/8	6.0	35	5-3	5.0	3/16
HN-102000	1/8	8.0	44	5-4	6.0	1/4
HN-102500	1/8	9.5	46	5	8.0	5/16
HN-103000	1/8	11.0	50	5-6.8	9.5	3/8
HN-202000	1/4	8.0	48	6-4	6.0	1/4
HN-202500	1/4	9.5	48	5	8.0	5/16
HN-203000	1/4	11.0	60	6.8	9.5	3/8
HN-203001	1/4	11.0	60	5	9.5	3/8
HN-204000	1/4	14.5	68	8	12.7	1/2
HN-204001	1/4	14.2	65	6	12.7	1/2
HN-302000	3/8	8.0	57	9.5-4	6.0	1/4
HN-303000	3/8	11.0	65	6.8	9.5	3/8
HN-304000	3/8	14.2	71	10	12.7	1/2
HN-304001	3/8	14.2	70	8	12.7	1/2
HN-306000	3/8	21.0	82	10-14	19.0	3/4
HN-404000	1/2	14.2	84	12-9.5	12.7	1/2
HN-406000	1/2	21.0	84	12-14	19.0	3/4
HN-606000	3/4	21.0	86	18-14	19.0	3/4
HN-608000	3/4	27.5	93	18	25.0	1

NPT Thread

Parts No.	Size				Hose Size	
	D	D ₁	L	H	mm	in
	NPT	mm	mm	mm	mm	in
HN-1N1500	1/8	6.0	35	5-3	5.0	3/16
HN-2N2000	1/4	8.0	48	6-4	6.0	1/4
HN-2N2500	1/4	9.5	48	5.5	8.0	5/16
HN-2N3000	1/4	11.0	50	6.8	9.5	3/8
HN-3N3000	3/8	11.0	65	6.8	9.5	3/8
HN-3N4000	3/8	14.2	70	9	12.7	1/2
HN-3N4001	3/8	14.2	70	8	12.7	1/2
HN-4N6000	1/2	21.0	84	12-14	19.0	3/4

SWIVEL HOSE NIPPLES

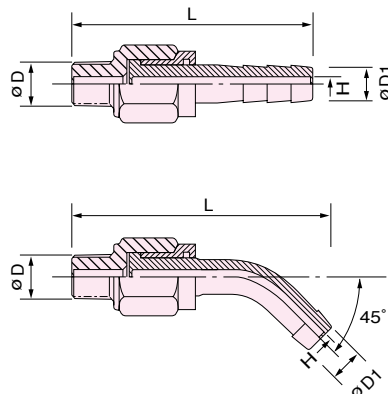
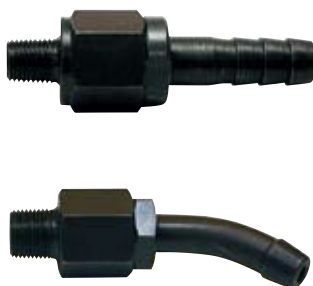

PT Thread

AC No.	Size				Hose Size	
	D	D ₁	L	H	mm	in
	PT	mm	mm	mm	mm	in
SJ-25	1/4	8.0	73	4	6.0	1/4
SJ-26	1/4	11.0	82	7	9.5	3/8
SJ-27	1/4	14.5	88	9	12.7	1/2
SJ-28	3/8	14.5	92	9	12.7	1/2
SJ-31	1/2	21.0	116	15	19.0	3/4
SJ-32	3/4	21.0	120	15	19.0	3/4
SJ-33	1	26.0	121	20	25.4	1
SJ-36	3/8	11.0	84	7	9.5	3/8
SJB-28	3/8	14.5	100	6	12.7	1/2

Air Line Accessories

QUICK COUPLING SOCKETS

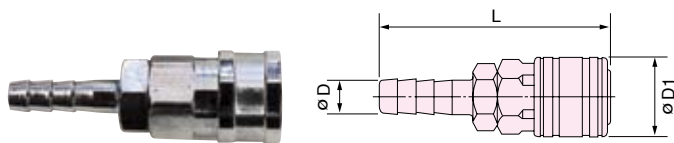

	AC No.	Size			Hose Size	
		D	D ₁	L	mm	in
		mm	mm	mm	mm	in
MSH-3	M-523	11.5	25	76.5	9.5	3/8
MSH-4	M-524	15	25	78.5	12.7	1/2
GSH-4	G-582	15	35	80	12.7	1/2
GSH-6	G-581	21	35	88	19.0	3/4
GSH-8	G-583	27	35	92	25.4	1

QUICK COUPLING PLUGS

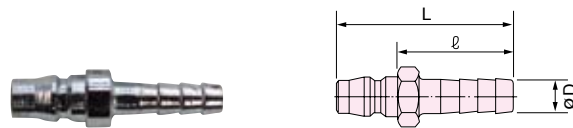

	AC No.	Size			Hose Size	
		D	L	l	mm	in
		mm	mm	mm	mm	in
MPH-1	M-620	7	57	30	4	1/8
MPH-2	M-622	9	57	30	6.3	1/4
MPH-3	M-624	11.5	61	34	9.5	3/8
MPH-4	M-625	15	65	38	12.7	1/2
GPH-8	G-663	27	78.5	45	25.4	1

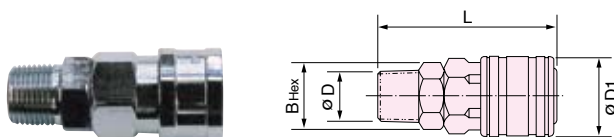

	AC No.	Size			
		D	D ₁	L	B(Hex)
		PT	mm	mm	mm
MSM-2	M-525	1/4	25	55.5	19
MSM-3	M-526	3/8	25	56.5	19
MSM-4	M-527	1/2	25	58.5	21
GSM-4	G-585	1/2	35	64	29
GSM-6	G-584	3/4	35	65	29
GSM-8	G-586	1	35	67	35

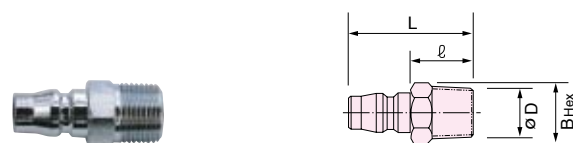

	AC No.	Size			
		D	L	l	B(Hex)
		PT	mm	mm	mm
MPM-1	M-626	1/8	38	16	14
MPM-2	M-627	1/4	40	20	14
MPM-3	M-628	3/8	40	20	17
MPM-4	M-629	1/2	46	26	21
GPM-4	G-666	1/2	50	26.5	21
GPM-6	G-665	3/4	54	30.5	27
GPM-8	G-664	1	57	33.5	35

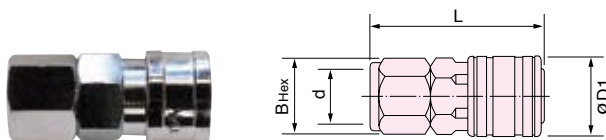

	AC No.	Size			
		d	D ₁	L	B(Hex)
		PT	mm	mm	mm
MSF-2	M-528	1/4	25	50.5	19
MSF-3	M-529	3/8	25	52.5	21
MSF-4	M-530	1/2	25	54.5	26
GSF-4	G-588	1/2	35	59	29
GSF-8	G-589	1	35	65	38

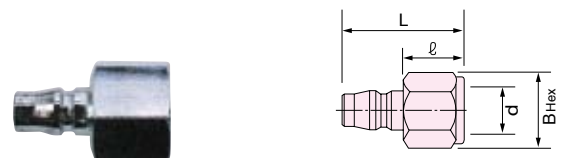

	AC No.	Size			
		d	L	l	B(Hex)
		PT	mm	mm	mm
MPF-1	M-630	1/8	33	13	14
MPF-2	M-631	1/4	36	16	17
MPF-3	M-632	3/8	38	18	21
MPF-4	M-633	1/2	41	21	26
GPF-4	G-670	1/2	45	21.5	29
GPF-8	G-668	1	48.5	25	38

*Socket and Plug are coupled with each other in the same color.

SWIVEL COUPLING PLUG

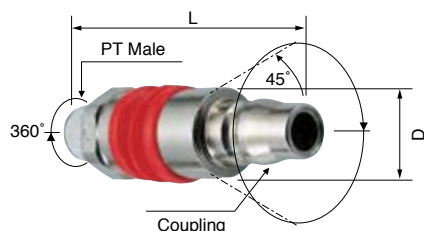

Model	Coupling	Male Thread	Dimension	
			D	L
	Plug	PT	mm	mm
FJP-2	1/4M	1/4	20.5	67

INLET HOSES

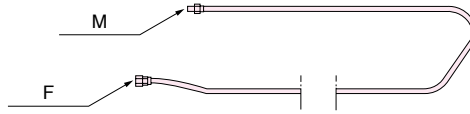

AC No.	Hose Size mm	Overall Length m	Thread Size		Models
			M PT	F PT	
IH-4B	4	2	1/8	1/4	TURBO-100, 100A
IH-4F	4	2	1/4-28 UNF (Female)	1/4	FG-06-1
IH-6A	6	2	1/4	1/4	FG-12UX, 13X, FW-5SXD, FD-4, 4P, 5, 5P
IH-8B	8	2	1/4	1/4	FG-26X, 25DX, 50X, 50DX, 3VX, FA-2CX, 3CX, FT-6BX, FCD-6EX
IH-8	8	2	1/4	3/8	FBM-16, 24, 80A

EXHAUST HOSES

*Exhaust hose is recommended to be used together with above Inlet Hoses.



EH30A, EH-151

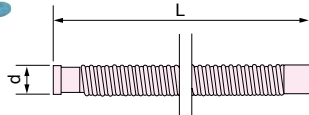

EH-50A

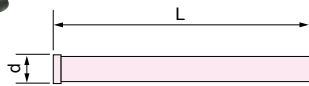

AC No.	Size d	Overall Length L	Recommended Air Hose AC No. To Use Together	Models
	mm	m		
EH-30A	14	0.3	IH-4F	FG-06-1
			IH-6A	FG-12UX, 13X, FW-5SXD
EH-50A	25	0.5	IH-8B	FG-25DX, 50X, 50DX, 26X, 3VX, FA-2CX
			IH-8	FBM-16, 24
EH-151	28	1.5	IH-8	FBM-80A

AIR DUSTER



AC No.	D
	PT
K-14	1/4

HOSE BANDS



AC No.	Hose Size	
	mm	in
HB-1	9.5	3/8
HB-2A	12.7	1/2

HOSE COUPLINGS

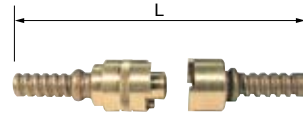

AC No. (Set)	AC No.		Size L	Hose Size PT
	Male	Female	mm	
K-10	K-10-1	K-10-2	143	3/8
K-11	K-11-1	K-11-2	152	1/2
K-12	K-12-1	K-12-2	173	3/4
K-13	K-13-1	K-13-2	190	1

HOSE BAND FASTENER



AC No.	HBS-1
--------	-------

EXTRA HOSE

*Not suitable for percussive tools.

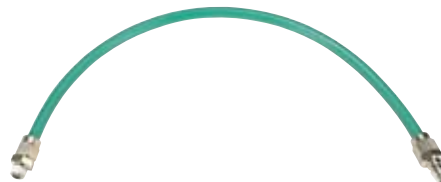

AC No.	Coupling	Male Thread	Length	Hose Inside Diameter	Max. Airpressure
	Plug	PT	mm	mm	MPa
IH-8.0P	1/4M	1/4	500	8.0	0.7

AIR LINE COCKS

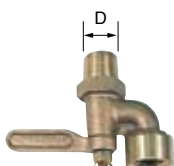

AC No.	Size D
	PT
K-16	3/4
K-17	1

TWO-WAY COUPLING



AC No.	Size D
	K-15

Spanners and Wrenches for Maintenance

OPEN-END WRENCHES

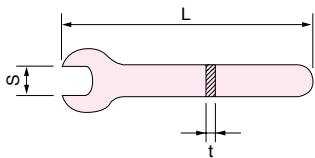

AC No.	Size			Models
	S	L	t	
	mm	mm	mm	
F-100	5.5	81	2.5	FBM-1-1, 1F, 2, 2F
F-101	8.0	80	3.0	FG-13, 13X, TURBO-100
F-102	9.5	80	1.5	FCD-6A, 6B
F-103	10.0	80	3.0	FRD-5P-1, 5S-1, 1F, 6PX-2, 3, 5, *F-6SM-12, 21, 28, 28R, FRD-6S-2, 3, 5
F-103-1	10.0	105	4.0	FBM-16, 24
F-104	12.0	88	3.0	FG-12U, 12UX, 25D, 25DX, 50D, 50DX, FRD-8PX-1, 2, *F-5SM-2, 8.5, *8SMA-12, 28
F-105	14.0	100	3.0	FG-12U, 12UX, 2VX-1F, 3VX-1F, 6F, 25D, 25DX, 50DX, 26, 26X, 50X, 50D, FA-2C, 2CX, TURBO-100A, FRD-6PX-7, 6S-7, 7F, 8PX-3, *F-6SM-2.5, 2.5R, *5, 8, F-6SE, 6SF, *8SM-8.5RA, *8SMA-8.5, 6PFX
F-106	17.0	130	3.0	FRD-16Z, FCD-6X, F-10MT
F-117-1	17.0	150	6.0	FBM-300
F-107	19.0	130	3.0	FCD-10X, FA-2C, 2CX, FT-8PX, FBM-80A
F-117	21.0	180	5.0	FG-3H, 3HL, 4HL, 50L, 50Y
F-109	24.0	200	4.0	FA-5E-3 Series, 7E-5, 6, 8 Series, FV-7, 9BH-1M, FX-027-1, FA-6C-6M, 8M, 9M, 9C-4, 4M
F-110	26.0	170	4.5	FA-150KG-5, 7, FA-5E-1, 2, 8, 13 Series, FA-7E-1, 2, 3 Series, 6C-1, 10, 12, 12M, 20, 9C-2, 2M, 7C-21
F-111	27.0	170	4.5	FG-5PX, FD-4, 4P
F-112	32.0	170	4.5	FG-3VX-2F, 3F, 4H, 4VA, 5HL, FA-4C, 4CH, 4CHK-1, FD-5, 5P
F-113	41.0	180	4.0	FV-9BH-4M, FRC-300-1

** = Thread Spindle type

HOOK SPANNERS

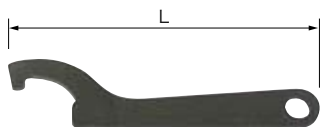

AC No.	Size		Models
	L	Thickness	
	mm	mm	
F-401	130	2	FD-4P, 4
F-402	160	2	FD-5P, 5
F-404	135	4.5	FA-3C, 3CX
F-405	170	4.5	FA-4CHK-3, 150K-2, 3

ANGLE WRENCH

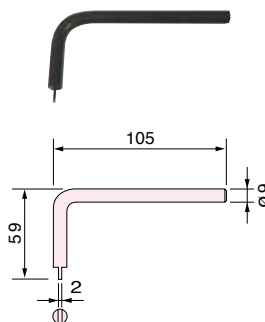

AC No.	Models
F-601	FD-5, 5P

OPEN-END PIN WRENCHES

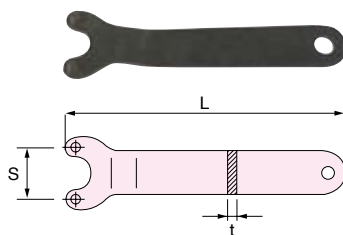

AC No.	Size			Models
	S	L	t	
	mm	mm	mm	
F-201	16	130	4.0	FG-5PX
F-202	30	160	4.5	FV-9BH-4M
F-203	32	180	4.5	FA-6C, 9C, 5E-13 Series, 7E-5, 6, 8 Series, FV-7-1M, 2M, 4M, 9BH-1M

HEXAGONAL PIN WRENCHES

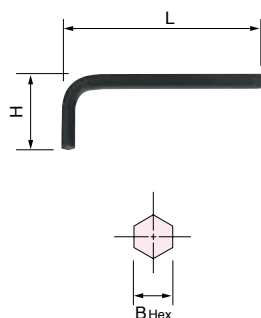

AC No.	Size			
	B(Hex)	L	H	
	mm	in	mm	mm
F-701-2	1.25	-	45	10
F-701	1.5	-	52	12
F-701-1	1.5	-	52	52
F-712	2.0	-	58	12
F-702-1	2.0	-	60	60
F-702	2.5	-	60	15
F-703	3.0	-	65	20
F-704	4.0	-	72	25
F-705	5.0	-	80	28
F-706	6.0	-	90	32
F-707	-	1/4	90	32
F-708	8.0	-	100	36
F-710	-	3/8	112	40
F-709	10.0	-	112	40

HEXAGONAL WRENCHES

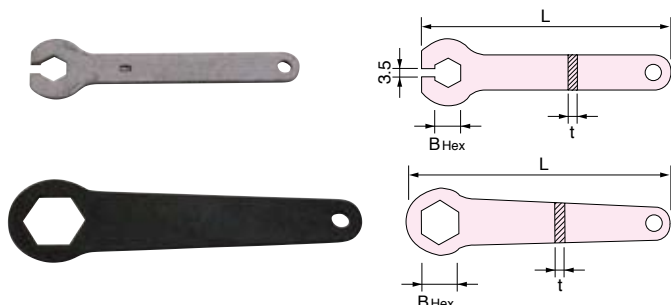

AC No.	Size			Models
	B(Hex)	L	t	
	mm	mm	mm	
F-301	8	80	3	TURBO-100, FG-06-1, 13, 13X
F-304	9	100	3	FG-06-1
F-306	14	101	4	TURBO-100A
F-302	17	135	2	FD-4P, 4
F-303	21	138	2	FD-5P, 5

Air Tools and Air Compressor

The capacity of an air compressor should be higher than the number of air tools in operation. In other words, when the respective factors are represented by the following signs, the expression should be $Q > Nq + a$.

- Q** : Capacity of Air Compressor
- q** : Air Consumption of Each Tool
- a** : Air Leakage in Piping
- N** : Number of Air Tools

The power of an air compressor necessary to compress air of 1 m³/min at the air pressure of 0.63 MPa is theoretically calculated at 4.44 kW (6 PS). But, the required power of an air compressor comes to 7.4 kW (10 PS) to 11.1 kW (15 PS) depending on the types of compressors (reciprocating or screw compressors) when the actual efficiency of an air compressor is taken into account. For instance, what capacity of an air compressor is required if 1 piece of FA-7C-4 angle grinder is used? Air of 1.4 m³/min is necessary to use 1 piece of FA-7C-4 angle grinder and the required power of an air compressor is calculated at 10.36 kW (14 PS) to 15.54 kW (21 PS). If 20 pieces of FA-7C-4 angle grinders are used at the same time, air of 19.6 m³/min is necessary and the required power of an air compressor is calculated at 145.0 kW to 217.6 kW (196 PS to 294 PS). Even if the number of tools changes, the required power of an air compressor can be obtained by simple calculation. Yet, when a number of air tools are used at the same time, it does not seem that all the air tools are concurrently used at the maximum air consumption, so the following

expression is given under our past experience.

- Air Tools : **A, B, C...**
- Number of Air Tools : **Na, Nb, Nc...**
- Air Consumption of Each Tool : **Ca, Cb, Cc...**
- Coefficient according to Number of Air Tools : **F**
- Total Air Consumption : **Q**

$$Q = F (Na \times Ca + Nb \times Cb + Nc \times Cc + \dots)$$

The coefficient is given as per the under-mentioned table according to the number of air tools. The coefficient is in inverse proportion to the number of air tools.

Number of Air tools	1-5	6-10	11-20	21-30	31-50	51-100
F	1.0	0.8	0.7	0.6	0.5	0.4

Those coefficients are obtained because air tools are not always in successive operation. It is usual that operations of air tools are intermitted for changing jobs, lubrication, changing grinding wheel, drill bit, chisel, etc. There is a case that even small capacity of an air compressor can be available due to an interval of jobs when such air tools as impact wrenches, screw drivers, etc. are in operation. The running time of those air tools for one job is 2 to 5 seconds and they are not used in succession for one job.

Air Tools and Air Pressure

Air Tools and Air Pressure

Air pressure should be maintained at less than the recommended air pressure at the inlet of the air tool. Our air tools are usually designed to be used at the air pressure of 0.63 MPa and the fluctuation of air pressure affects the performance of the air tool. For instance, if the power of an air tool is 0.74 kW (1 PS) at the air pressure of 0.63 MPa, the power of the air tool generally comes to the following figures at each air pressure.

Air Pressure (MPa)	0.70	0.63	0.50	0.40	0.30
Power (kW)	0.93	0.74	0.56	0.40	0.26

It should be taken into account that air pressure drops at the inlet of the air tool due to the resistance and leakage caused when air passes in the pipe even if the air pressure is 0.63 MPa at the outlet of the air compressor. Needless to say, the loss of power may be caused unless the appointed air hose is used.

On the contrary, when air pressure fluctuates higher than the recommended air pressure at the inlet of the air tool, parts may consume comparatively faster, and what is worse, accidental operations may be induced, so air pressure should be maintained at less than the recommended air pressure at the inlet of the air tool in any case.

Piping

Piping layout is very important to use the air tool efficiently. When a pipe is connected to an air compressor, the pipe should be installed at a reasonably high position from the air compressor to prevent drain from coming into the pipe from the air compressor. A slope more than 1/100 is necessary to drain water easily. The diameter of the main pipe should be determined according to an average air flow at load. The diameter of branch pipes should be 50% to 70% of the main pipe. Thin pipes may cause the drop of air pressure, so the pipes should be chosen lest air pressure should drop more than 0.0315 MPa. The drop of air pressure due to joints, elbows, etc. should be also taken into account.

Drop of Air Pressure (MPa) in 100 M
Straight Pipe at Air Pressure of 0.63 MPa

Pipe Inside Dia. (mm)	Air Consumption (m ³ /min)					
	0.5	1.0	2.0	5.0	10.0	15.0
20	0.0095	0.0380	0.1428			
25	0.0038	0.0095	0.0476	0.2380		
32		0.0038	0.0190	0.0761	0.2857	
40			0.0038	0.0285	0.0857	0.1142
50				0.0076	0.0476	0.0571
60				0.0028	0.0095	0.0190
70					0.00476	0.0095
80						0.0028

Drop of Air Pressure (MPa) in 10 M
Air Hose at Air Pressure of 0.63 MPa

Hose Dia. (mm)	Air Consumption (m ³ /min)						
	0.5	1.0	1.5	2.0	2.5	3.0	4.0
9.5mm (3/8")	0.0095	0.0485					
12.7mm (1/2")	0.0047	0.0317	0.0948	0.1826			
19.0mm (3/4")	0.0009	0.0041	0.0087	0.0190	0.0306	0.0463	
25.0mm (1")		0.0009	0.00213	0.0041	0.0074	0.0105	0.0126
38.0mm (1 1/2")					0.0005	0.0009	0.0013

Drop of Air Pressure in Coupling
(Valve, Elbow, etc.)

Pipe inside Dia. (mm)	Drop of air pressure in valve (m)	Drop of air pressure in elbow (m)
25	0.61	0.41
38	1.24	0.92
50	2.14	1.53
65	3.05	2.14
75	3.96	2.76
90	4.82	3.36
100	6.10	3.90
125	8.54	5.82
150	11.00	7.30

Recommended Piping Lay-Out for Air Line System

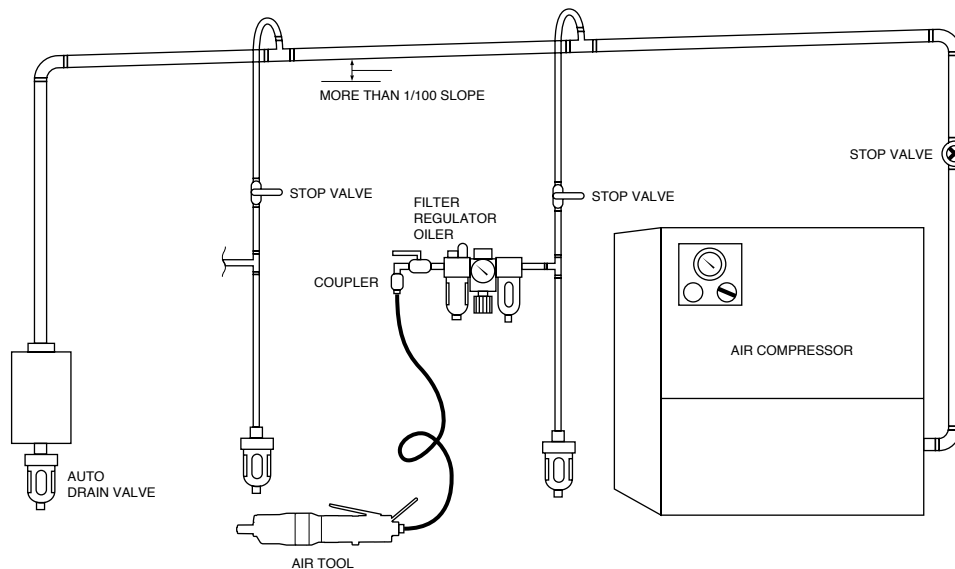



Dimensions

ASSEMBLY TOOLS	120
ABRASIVE TOOLS	124
DRILLS / TAPPERS	130
PERCUSSIVE TOOLS	132
AIR MOTORS	134
OTHERS	137

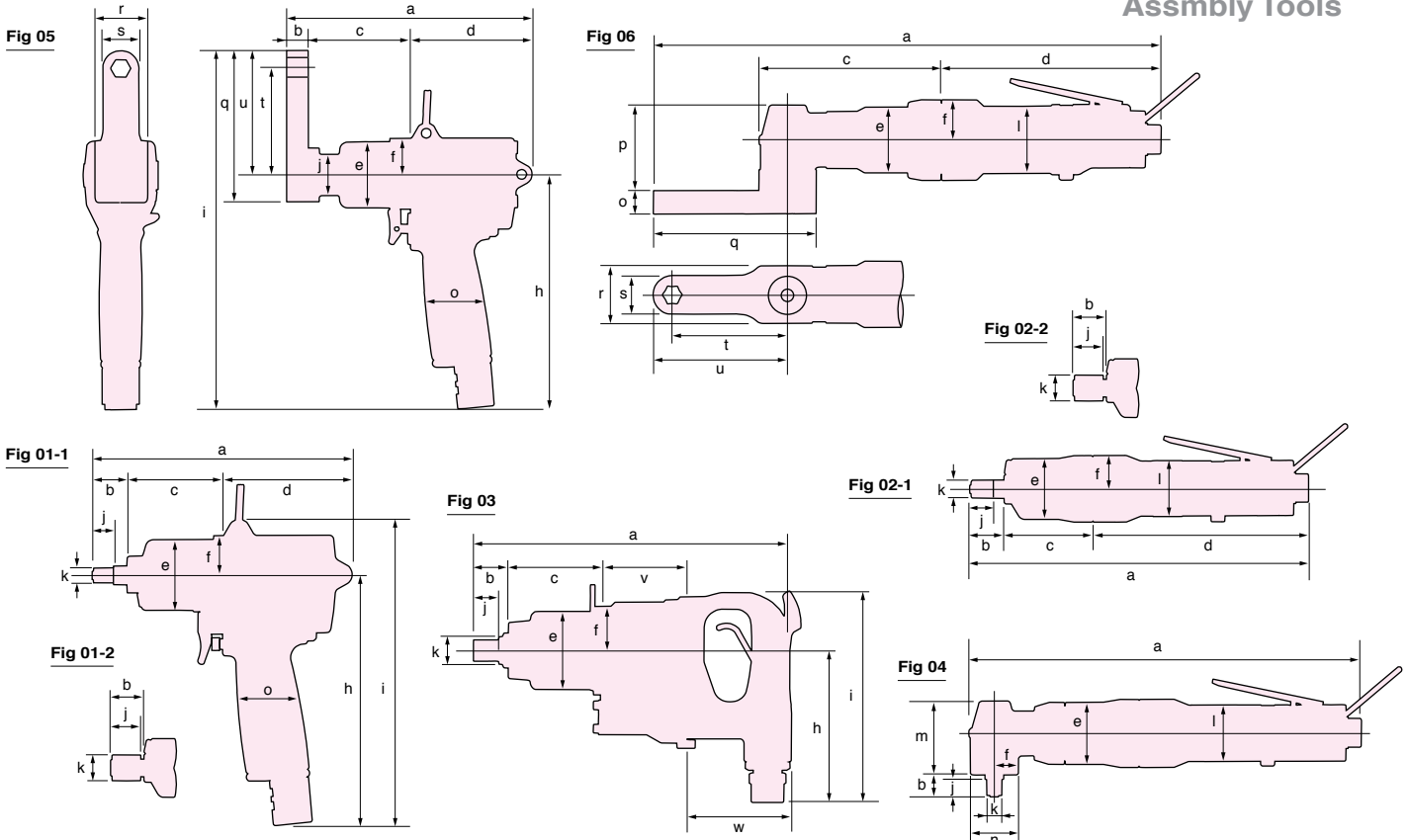

GEARED PULSE WRENCHES SHUT-OFF TYPE

Fig No.	Model	a	b	c	d	e	f	h	i	j	o	q	r	s	t	u
05	FPT-770G-1	202	15	88.5	98.5	47	29	169	259	29	41	109	38	25	78	90
Fig No.	Model	a	c	d	e	f	l	o	p	q	r	s	t	u		
06	FPT-770SCG-1	378	136	171	50	27	45	15	58	109	38	25	78	90		

Fig No.	Model	a	b	c	d	e	f	h	i	j	o	q	r	s	t	u
05	FPT-770G-1L	202	15	88.5	98.5	47	29	169	259	29	41	109	38	25	78	90

PULSE WRENCHES

Pistol Grip Models

Fig No.	Model	a	b	c	d	e	f	h	i	j	k	o
01-1	FPW-110-1	143	23.5	63.5	56.0	35	20.0	144	163	12.0	12	33
01-1	FPW-330-1	151	24.0	57.0	70.0	42	22.5	144	166	12.0	12	39
01-1	FPW-440-3	151	24.0	57.0	70.0	42	22.5	144	166	12.0	12	39
01-1	FPW-550-3	151	24.0	57.0	70.0	42	22.5	144	166	12.0	12	39
01-1	FPW-660-4	163	24.0	57.0	82.0	42	22.5	144	166	12.0	12	39
01-1	FPW-770-3	175	23.5	64.5	87.0	47	26.0	168	206	12.0	12	41
01-1	FPW-880-6	190	28.0	73.0	89.0	53	27.0	173	210	16.5	16	41
01-1	FPW-990-3	190	28.0	69.0	93.0	57	29.0	175	216	16.5	16	41
01-1	FPW-1110-1	193	28.0	69.0	96.0	60	31.0	175	219	16.5	16	41
01-1	FPW-1330-1	206	28.0	77.0	101.0	66	34.0	180	227	16.5	16	44
01-1	FPW-1660-1	243	36.0	88.5	118.5	70	39.0	205	256	24.0	25	48

Pistol Grip Models

Fig No.	Model	a	b	c	d	e	f	h	i	j	k	o
01-2	FPW-110D-1(10)	149	29.5	63.5	56	35	20.0	144	163	21	18	33
01-2	FPW-330D-1(10)	151	24.0	57.0	70	42	22.5	144	166	21	18	39
01-2	FPW-440D-3(30)	151	24.0	57.0	70	42	22.5	144	166	21	18	39
01-2	FPW-550D-3(30)	151	24.0	57.0	70	42	22.5	144	166	21	18	39
01-2	FPW-660D-4(40)	163	24.0	57.0	82	42	22.5	144	166	21	18	39
01-2	FPW-770D-3(30)	174	22.5	64.5	87	47	26.0	168	206	21	18	41

Straight Models

Fig No.	Model	a	b	c	d	e	f	j	k	l
02-1	FPW-110S-1	218	23.5	63.5	131	35	20.0	12	12	30.5
02-1	FPW-330S-1	226	24.0	57.0	145	42	22.5	12	12	38.0
02-1	FPW-440S-1	226	24.0	57.0	145	42	22.5	12	12	38.0
02-1	FPW-550S-1	226	24.0	57.0	145	42	22.5	12	12	38.0
02-1	FPW-660S-1	238	24.0	62.0	152	42	23.0	12	12	38.0
02-1	FPW-770S-1	240	24.0	67.0	149	44	27.0	12	12	47.0

Fig No.	Model	a	b	c	v	w	e	f	h	i	j	k
03	FPW-2220S-1	352.5	36	103	112	101.5	90	47.5	144	204	24	25

Fig No.	Model	a	b	c	d	e	f	j	k	l
02-2	FPW-110SD-1(10)	224	29	63	132	35	20.0	21	18	30.5
02-2	FPW-330SD-1(10)	226	24	57	145	42	22.5	21	18	38.0
02-2	FPW-440SD-1(10)	226	24	57	145	42	22.5	21	18	38.0
02-2	FPW-550SD-1(10)	226	24	57	145	42	22.5	21	18	38.0
02-2	FPW-660SD-1(10)	238	24	62	152	42	23.0	21	18	38.0

Angle Head Models

Fig No.	Model	a	b	e	f	j	k	l	m	n
04	FPW-440SC-1	255	15	41	14.5	12	12	38	41.5	29
04	FPW-550SC-1	255	15	41	14.5	12	12	38	41.5	29
04	FPW-660SC-1	267	15	42	16.0	12	12	38	50.0	32
04	FPW-770SC-1	271	16	44	18.0	12	12	47	55.0	36

GEARED PULSE WRENCHES

Fig No.	Model	a	b	c	d	e	f	h	i	j	o	q	r	s	t	u
05	FPW-770G-1	177	15	75	87	47	26	169	258	29	41	109	38	25	78	90
Fig No.	Model	a	c	d	e	f	l	o	p	q	r	s	t	u		
06	FPW-770SCG-1	343	124	148	44	27	45	15	58	109	38	25	78	90		

Dimensions

Assembly Tools

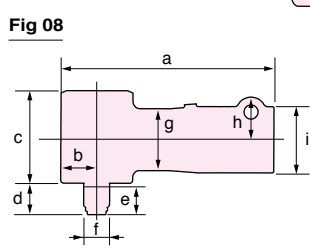
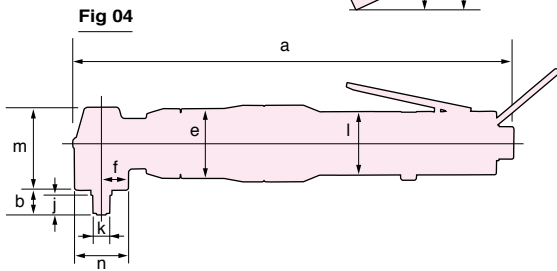
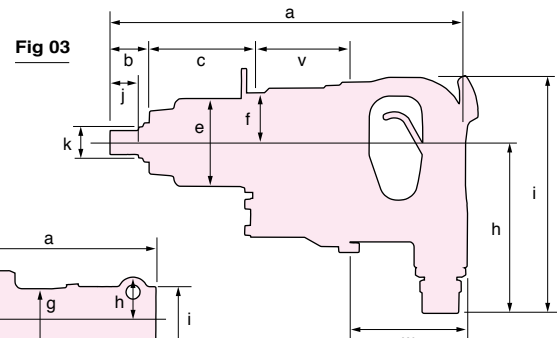
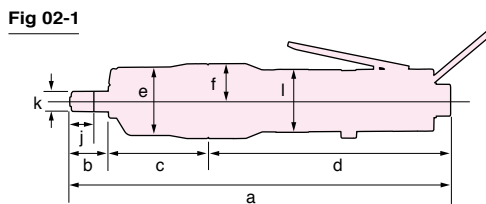
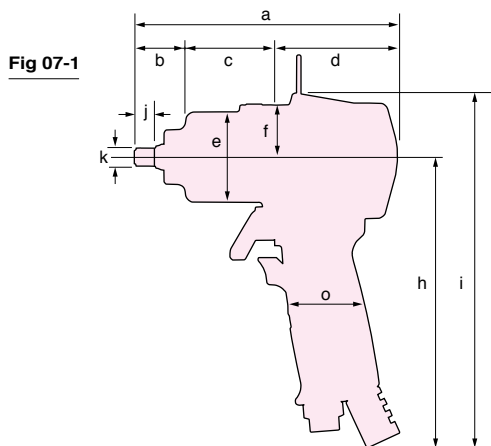

"DUAL CHAMBER MOTOR" IMPACT WRENCHES

Pistol Grip Models

Fig No.	Model	a	b	c	d	e	f	h	i	j	k	o
07-1	FW-44PA-2	131.0	23.0	38.0	70.0	39.5	22.5	144.0	166.0	12.0	12	38
07-1	FW-66PA-2	137.0	18.0	49.0	70.0	42.0	22.5	144.0	166.0	12.0	12	38
07-1	FW-88P-1	163.0	22.5	54.0	86.5	50.0	29.0	173.0	211.0	16.5	16	41

Straight Models

Fig No.	Model	a	b	c	d	e	f	j	k	l
02-1	FW-44SA-1	197.5	14.5	38	145	39.5	22.5	12	12	38
02-1	FW-66SA-1	212.0	18.0	49	145	42.0	22.5	12	12	38

IMPACT WRENCHES

Small Pistol Grip Models

Fig No.	Model	a	b	c	d	e	f	h	i	j	k	o
07-1	FW-5PX-6	150.0	14.0	49.0	87.0	34.0	18.0	137.0	155.0	12.0	12.0	36.0
07-1	FW-6PM-1	140.0	18.0	48.0	74.0	42.0	23.5	145.0	168.0	12.0	12.0	38.0
07-1	FW-6PL-1	175.0	18.0	52.5	104.5	42.0	27.0	122.0	152.0	12.0	12.0	35.0
07-1	FW-6PX-5(6)	166.0	15.0	57.0	94.0	44.0	24.0	146.0	172.0	12.0	14.0	40.0
07-1	FW-6PH-1(11)	147.0	16.5	62.0	68.5	50.0	29.0	162.0	198.0	12.0	14.0	43.0
07-1	FW-8PH-3	162.0	21.0	65.0	76.0	54.0	29.0	168.0	208.0	16.5	16.0	45.5
07-1	FW-10PX-5	181.8	20.8	78.0	83.0	55.5	29.0	188.0	229.0	17.0	17.0	44.0
07-1	FW-10PH-1	179.4	23.9	77.5	78.0	58.0	33.0	171.0	214.0	17.0	17.0	44.3
07-1	FW-10PH-2	179.0	24.0	77.0	78.0	58.0	31.0	171.0	213.0	16.5	17.0	44.3
07-1	FW-14PX-5	197.3	21.3	93.0	83.0	66.0	34.5	192.0	237.0	16.5	16.8	50.0
07-1	FW-14PH-1	202.0	23.0	94.5	84.5	67.0	37.5	181.5	229.5	16.5	16.8	47.6
07-1	FW-14PH-2	202.0	23.0	94.0	85.0	67.0	37.5	181.0	228.0	16.5	20.0	47.6
07-1	FW-14PH-3	202.0	23.0	94.0	85.0	67.0	37.5	181.0	228.0	18.5	20.0	47.6

Straight Models

Fig No.	Model	a	b	c	d	e	f	j	k	l
02-1	FW-6SX-5	223	16	57	151	44.0	24	12.0	12	50
02-1	FW-6SX-6	225	16	57	152	44.0	24	12.0	14	50
02-1	FW-8SH-2	307	20	65	222	54.0	33	16.5	16	44
02-1	FW-10SX-5	318	21	78	219	55.5	33	17.0	17	44
02-1	FW-14SX-5	356	20	93	243	66.0	38	16.5	20	44

Angle Models

Fig No.	Model	a	b	e	f	j	k	l	m	n
04	FW-6SCX-6	262	13	44	17.5	12.0	12	49.5	46	35
04	FW-8SCH-2	354	20	58	22.0	16.5	16	44.0	63	44

CORNER ATTACHMENT(ANGLE HEAD)

Fig No.	Model	a	b	c	d	e	f	g	h	i
08	CA-14A	146	24.5	63	21	16.5	17	42	28	45

IMPACT WRENCHES

Middle Size Straight Models

Fig No.	Model	a	b	c	v	w	e	f	h	i	j	k
03	FW-19Z-5(5C)	322	29.0	109.0	72.0	112.0	72	39.0	111	175	54	25
03	FW-250-1(1C)	302	33.0	88.0	81.5	99.5	73	41.5	143	198	28	32
03	FW-250-2(2C)	302	33.0	88.0	81.5	99.5	73	41.5	143	198	24	32
03	FW-320-1(1C)	353	51.5	115.5	86.5	99.5	87	51.0	143	198	28	42
03	FW-320-1L(1CL)	484	182.0	116.0	86.5	99.5	87	51.0	143	198	28	40
03	FW-420-1(1C)	349	34.0	132.0	80.0	103.0	93	55.0	143	198	28	42
03	FW-420-1L(1CL)	501	186.0	132.0	80.0	103.0	93	55.0	143	198	28	42
03	FW-420-2(2C)	351	36.0	132.0	80.0	103.0	93	55.0	143	198	30	42

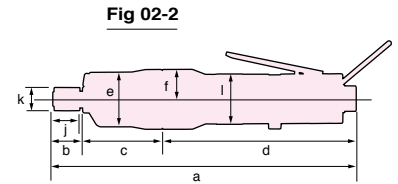
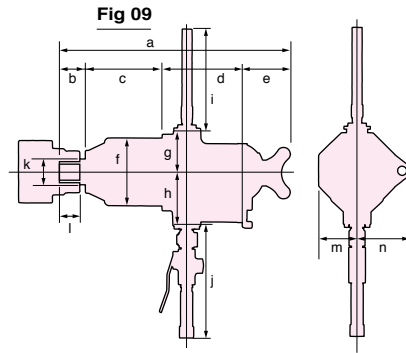
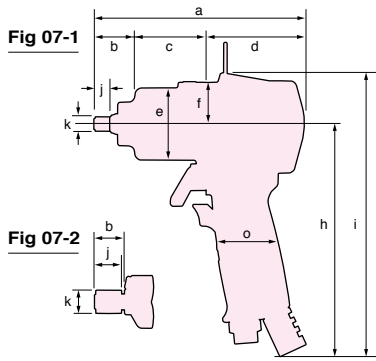

IMPACT WRENCHES

Middle Size Pistol Grip Models

Fig No.	Model	a	b	c	d	e	f	h	i	j	k	o
07-1	FW-19PX-5	239.0	29.0	109.0	101.0	72.0	40.0	200.0	249.0	24.0	25	50
07-1	FW-250P-1	228.0	33.0	88.0	107.0	73.0	41.5	205.5	265.0	28.0	32	46
07-1	FW-250P-2	228.0	33.0	88.0	107.0	73.0	41.5	205.5	265.0	24.0	32	46
07-1	FW-320P-1	268.0	51.5	115.5	101.0	87.0	51.0	210.0	261.0	28.0	40	46

Heavy Duty Straight Models

Fig No.	Model	a	b	c	d	e	f	g	h	i	j	k	l	m	n
09	FW-50-7	500	50	220	110	120	142	100	120	298	340	49.8	40	90	100
09	FW-75-7	608	68	264	134	142	175	120	150	298	340	84.0	58	164	107
09	FW-100-1	710	77	253	232	148	212	130	160	316	358	80.0	58	118	165

SCREW DRIVERS

Impact Clutch Type

Straight Models

Fig No.	Model	a	b	c	d	e	f	j	k	l
02-2	FW-5SXD-7(70)	223	24	50	149	34	18	21	18	33.0
02-2	FW-5SXD-8(80)	194	27	50	117	34	18	21	18	33.0
02-2	FW-6SXD-6(60)	235	27	57	151	44	24	21	18	49.5

Pistol Grip Models

Fig No.	Model	a	b	c	d	e	f	h	i	j	k	o
07-2	FW-5PXD-6(60)	160	24.0	49.5	86.5	34	18.0	137	155	21	18	36
07-2	FW-6PMD-1(10)	146	24.0	48.0	74.0	42	23.5	145	168	21	18	38
07-2	FW-6PLD-1	180	23.5	52.5	104.0	42	30.0	122	152	20	19	35
07-2	FW-6PXD-6(60)	177	27.0	57.0	93.0	44	24.0	146	181	21	18	40
07-2	FW-6PHD-1	154	24.0	62.0	68.0	50	29.0	162	198	21	19	43

Straight Models

Fig No.	Model	a	b	c	d	e	f	j	k	l
02-2	FW-44SAD-1(10)	207	24	38	145	39.5	22.5	21	18	38
02-2	FW-66SAD-1(10)	218	24	49	145	42.0	22.5	21	18	38

Pistol Grip Models

Fig No.	Model	a	b	c	d	e	f	h	i	j	k	o
07-2	FW-44PAD-2(20)	132.0	24	38.0	70	39.5	22.5	144	166	21	18	38
07-2	FW-66PAD-2(20)	143.0	24	49.0	70	42.0	22.5	144	166	21	18	38

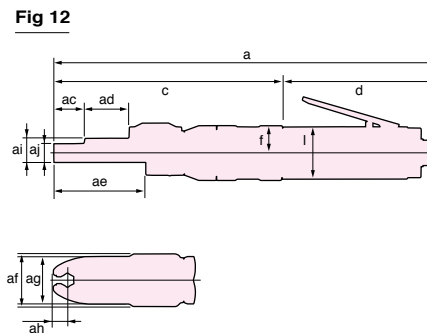
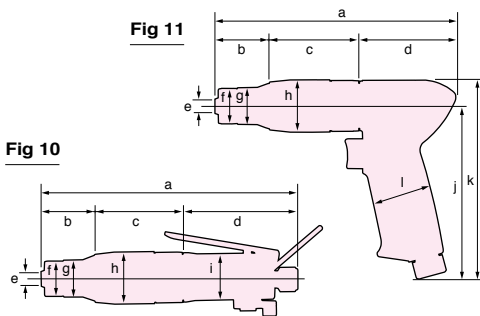

Slip Clutch Type

Straight Models

Fig No.	Model	a	b	c	d	e	f	g	h	i
10	FD-4	174	38.5	64	71.5	7.4	25	26	37	32
10	FD-5	233	45.0	92	96.0	7.4	25	32	42	38

Pistol Grip Models

Fig No.	Model	a	b	c	d	e	f	g	h	j	k	l
11	FD-4P	173	39	64	70	7.4	25	26	37	125	143	42
11	FD-5P	210	45	92	73	7.4	25	32	42	130	150	42

OPEN-END WRENCHES

Fig No.	Model	a	c	d	f	l	ac	ad	ae	af	ag	ai	aj	ah
12	FOW-10-1	294	177	117	21	40	23.5	34.4	71	40	36	18	14	10.5
12	FOW-10-2	306	189	117	21	40	28.0	42.0	83	40	40	18	14	14.0

RATCHET WRENCHES

Fig No.	Model	a	c	d	e	f	l	v	w	x	y	z	aa	ab
13	FRW-6NX-3(3A)	316.0	182.0	134	38.6	21.5	32	20	13(10)	13(10)	88.0	20.2(15.2)	10.0	28.0
13	FRW-6NX-4(4A)	320.0	186.0	134	38.6	21.5	32	24	13(10)	13(10)	92.7	20.2(15.2)	12.0	30.7
13	FRW-8NX-2(2A)	380.0	217.0	163	46.0	25.0	48	25	18(10)	16(10)	108.0	25.5(15.2)	12.5	32.0
13	FRW-10N-2	417.0	228.0	189	46.0	29.0	32	33	18	16	115.0	25.5	16.5	37.5
13	FRW-13N-3	418.5	229.5	189	46.0	29.0	32	36	18	16	116.0	25.5	18.0	37.5
13	FRW-13N-4	431.0	242.0	189	46.0	29.0	32	46	18	16	129.0	25.5	23.0	45.0

Dimensions

Abrasive Tools

Fig 14

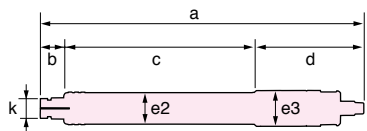

Fig 15

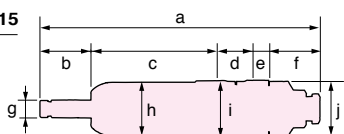

Fig 16-1

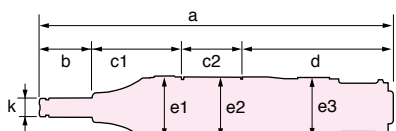

Fig 16-2

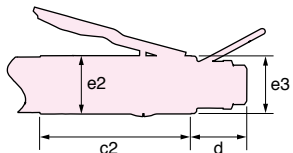

Fig 16-3

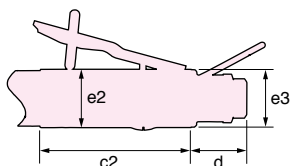

Fig 17-1

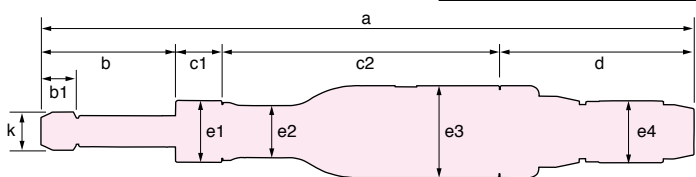

Fig 17-2

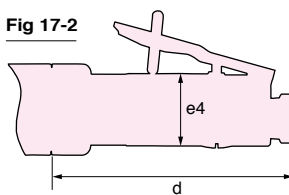

Fig 18-2

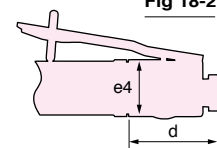

Fig 19-1

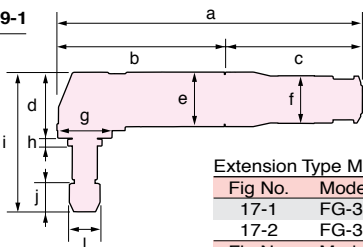

Fig 19-2

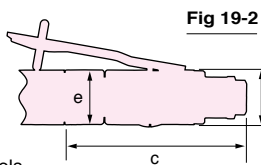
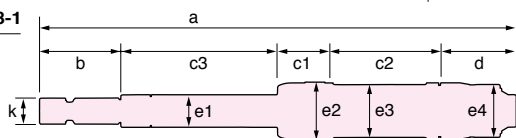

Fig 18-1



Extension Type Models

Fig No.	Model	a	b1	b	c1	c2	d	e1	e2	e3	e4	k
17-1	FG-3H-5	344	18	71	24	148	101	32	27	48	32	17Hex
17-2	FG-3H-5F	369	18	71	24	148	126	32	27	48	38	17Hex
Fig No.	Model	a	b	c3	c1	c2	d	e1	e2	e3	e4	k
18-1	FG-26L-1	297	51	98	31	70	47	20	36	33	33	16
18-2	FG-26L-1BF	307	51	98	31	71	56	20	36	33	35	16

AngleType Models

Fig No.	Model	a	b	c	d	e	f	g	h	i	j	l
19-1	FA-2C-2	157	110	47	42.5	35	33	35	5	90.3	18	17Hex
19-1	FA-2C-3	157	110	47	42.5	35	33	35	5	90.3	18	17Hex
19-2	FA-2C-2BF	190	110	80	42.5	35	35	35	5	90.3	18	17Hex
19-2	FA-2C-3BF	190	110	80	42.5	35	35	35	5	90.3	18	17Hex

Rear Exhaust Type

Fig No.	Model	a	b	c	d	e	f	g	h	i	j	l
19-1	FA-2CX-2	197	109	88	42.5	35	30.5	35	5	90.3	18	17Hex
19-1	FA-2CX-3	197	109	88	42.5	35	30.5	35	5	90.3	18	17Hex
19-2	FA-2CX-2BF	226	109	117	42.5	35	35.0	35	5	90.3	18	17Hex
19-2	FA-2CX-3BF	226	109	117	42.5	35	35.0	35	5	90.3	18	17Hex

PENCIL GRINDERS

Fig No.	Model	a	b	c	d	e2	e3	k
14	FG-06-1	153	11	90	52	14.5	16	9.5

TURBO GRINDERS

Fig No.	Model	a	b	c	d	e	f	g	h	i	j
15	TURBO-100	153	28	70	18	9.0	28	9.5	29	31	29
15	TURBO-100A	155	30	70	18	9.0	28	16.0	29	31	29

DIE GRINDERS

Roll Handle Models

Fig No.	Model	a	b	c1	c2	d	e1	e2	e3	k
16-1	FG-12U-2	191.0	28.5	47.5	79.5	35.5	36.0	35	33.0	17.0
16-1	FG-13-2	149.5	27.0	42.0	35.0	45.5	30.5	29	33.0	9.5
16-1	FG-13-20	149.5	43.5	25.5	35.0	45.5	30.5	29	33.0	9.5
16-1	FG-25D-2	202.0	28.0	54.5	84.0	35.5	38.5	39	33.0	30.0
16-1	FG-26-20	171.0	49.0	30.0	45.0	47.0	35.5	33	33.0	16.0
16-1	FG-50-2	180.0	48.5	29.0	54.5	48.0	39.5	36	37.0	16.0
16-1	FG-50D-2	213.0	28.0	51.0	98.5	35.5	40.5	41	37.0	17.0
16-1	FG-12UX-2	211.0	29.0	40.0	54.0	88.0	36.0	36	30.5	17.0
16-1	FG-13X-2	179.0	27.0	42.0	35.5	74.5	30.5	29	30.0	9.5
16-1	FG-13X-10	179.0	44.0	25.5	85.5	24.0	30.5	29	30.0	9.5
16-1	FG-25DX-2	227.0	28.0	50.0	61.0	88.0	38.5	36	30.5	17.0
16-1	FG-26X-20	211.0	49.0	30.0	44.0	88.0	35.5	33	30.5	16.0
16-1	FG-50DX-2	237.0	26.5	52.5	72.0	86.0	40.5	42	30.5	17.0
16-1	FG-50X-2	218.0	48.5	29.0	54.5	86.0	39.5	36	30.5	16.0

Lever Handle Models

Fig No.	Model	a	b	c1	c2	d	e1	e2	e3	k
16-2	FG-12U-1	188.0	28.5	48.0	101.5	10.0	36.0	35	34.0	17.0
16-2	FG-13-1	158.0	27.0	42.0	76.0	13.0	30.5	32	32.0	9.5
16-2	FG-13-10	158.0	43.5	25.5	76.0	13.0	30.5	32	32.0	9.5
16-2	FG-25D-1	198.0	28.0	52.0	108.0	10.0	38.5	39	38.0	17.0
16-2	FG-26-10	179.0	49.0	30.0	90.0	10.0	35.5	36	35.0	16.0
16-2	FG-50-1	191.0	49.0	29.0	103.0	10.0	39.5	37	38.0	16.0
16-2	FG-50D-1	210.0	28.0	51.0	121.0	10.0	40.5	41	40.0	17.0
16-2	FG-12UX-1	213.0	28.0	40.0	111.0	34.0	35.5	36	34.0	17.0
16-2	FG-13X-1	183.0	27.0	42.0	83.5	30.5	30.5	32	32.0	9.5
16-2	FG-13X-10	183.0	43.5	25.5	83.5	30.5	30.5	32	32.0	9.5
16-2	FG-25DX-1	231.0	28.0	50.0	119.0	34.0	38.5	39	34.0	17.0
16-2	FG-26X-10	206.0	49.0	30.0	96.5	30.5	35.5	35	34.0	16.0
16-2	FG-50DX-1	243.0	26.0	52.5	129.0	35.5	40.5	41	34.0	17.0
16-2	FG-50X-1	214.0	48.5	29.0	106.0	30.5	39.5	41	34.0	16.0

Locking Lever Handle Models

Fig No.	Model	a	b	c1	c2	d	e1	e2	e3	k
16-3	FG-12U-1F	188.0	28.5	48.0	101.5	10.0	36.0	35	34.0	17.0
16-3	FG-13-1F	158.0	27.0	42.0	76.0	13.0	30.5	32	32.0	9.5
16-3	FG-13-10F	158.0	43.5	25.5	76.0	13.0	30.5	32	32.0	9.5
16-3	FG-25D-1F	198.0	28.0	52.0	108.0	10.0	38.5	39	38.0	17.0
16-3	FG-26-10F	179.0	49.0	30.0	90.0	10.0	35.5	36	35.0	16.0
16-3	FG-26-20BF	180.0	49.0	30.0	45.0	56.0	35.5	33	33.0	16.0
16-3	FG-50-1F	191.0	49.0	29.0	103.0	10.0	39.5	37	38.0	16.0
16-3	FG-50-2BF	189.0	49.0	29.0	54.0	57.0	39.5	36	39.0	16.0
16-3	FG-50D-1F	210.0	28.0	51.0	121.0	10.0	40.5	41	40.0	17.0
16-3	FG-12UX-1F	213.0	28.0	40.0	111.0	34.0	35.5	36	34.0	17.0
16-3	FG-13X-1F	183.0	27.0	42.0	83.5	30.5	30.5	32	32.0	9.5
16-3	FG-13X-10F	183.0	43.5	25.5	83.5	30.5	30.5	32	32.0	9.5
16-3	FG-25DX-1F	231.0	28.0	50.0	119.0	34.0	38.5	39	34.0	17.0
16-3	FG-26X-10F	206.0	49.0	30.0	96.5	30.5	35.5	35	34.0	16.0
16-3	FG-50DX-1F	243.0	26.0	52.5	129.0	35.5	40.5	41	34.0	17.0
16-3	FG-50X-1F	214.0	48.5	29.0	106.0	30.5	39.5	41	34.0	16.0

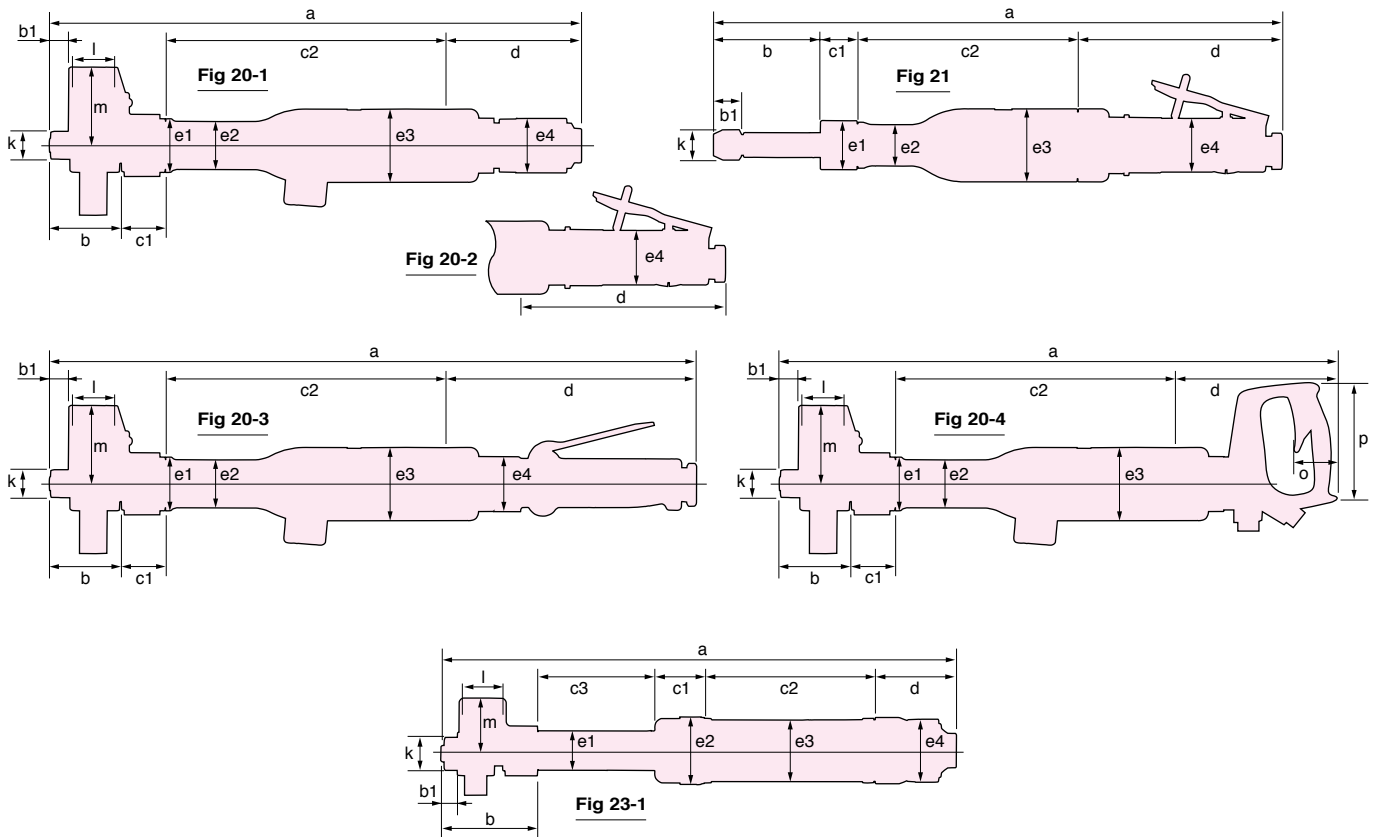

LOW SPEED GRINDERS

Roll Handle Models

Fig No.	Model	a	b1	b	c1	c2	d	e1	e2	e3	e4	k	l	m
20-1	FG-3H-6	329.0	14	56.0	24	148	101.0	32	27	48.0	32.0	17Hex	29.3	41.0
20-1	FG-4VA-1	385.0	14	53.0	31	203	98.0	38	34	52.0	38.5	17Hex	30.0	45.5
20-1	FG-4VA-2	391.0	17	59.0	31	203	98.0	38	34	52.0	38.5	21Hex	31.0	58.5

Locking Lever Handle Models

Fig No.	Model	a	b1	b	c1	c2	d	e1	e2	e3	e4	k
21	FG-2VX-1F	216.0	18	47.0	57.0	83	29.0	16	39	44.0	44	17Hex
21	FG-3VX-1F	331.0	18	70.5	26.5	97	137.0	16	40	41.0	34	17Hex
21	FG-3VX-6F	331.0	18	70.5	26.5	97	137.0	16	40	41.0	34	17Hex
20-2	FG-3VX-2F	316.0	14	55.5	26.5	97	137.0	-	40	41.0	34	17Hex
20-2	FG-3VX-3F	316.0	14	55.5	26.5	97	137.0	-	40	41.0	34	17Hex

STRAIGHT GRINDERS

Roll Handle Models

Fig No.	Model	a	b1	b	c1	c2	d	e1	e2	e3	e4	k	l	m
20-1	FG-3H-1	317.0	14	44.0	24	148	101.0	32	27	48.0	32.0	17Hex	18.0	41.0
20-1	FG-3H-2	317.0	14	44.0	24	148	101.0	32	27	48.0	32.0	17Hex	18.0	46.0
20-1	FG-4H-1	383.0	14	52.0	31	202	98.0	38	34	52.0	38.5	17Hex	31.0	58.5
20-1	FG-4H-2	391.0	14	60.0	31	202	98.0	38	34	52.0	38.5	21Hex	31.0	58.5
20-1	FG-5H-1	405.0	14	58.0	31	210	106.0	38	34	58.0	38.5	21Hex	27.0	72.0
20-1	FG-5H-2	410.0	23	63.0	31	210	106.0	38	34	58.0	38.5	26Hex	27.0	72.0
20-1	FG-6H-1	434.0	23	76.0	31	210	117.0	38	36	64.0	42.0	26Hex	34.0	84.7
20-1	FG-8H-1	472.0	23	78.0	30	232	132.0	52	40	80.0	42.0	26Hex	38.0	111.2
20-1	FG-8H-2	472.0	23	78.0	30	232	132.0	52	40	80.0	42.0	26Hex	34.8	99.7

Locking Lever Handle Models

Fig No.	Model	a	b1	b	c1	c2	d	e1	e2	e3	e4	k	l	m
20-2	FG-3H-1F	342.0	14	44.0	24	148	126.0	32	27	48.0	38.0	17Hex	18.0	41.0
20-2	FG-3H-2F	342.0	14	44.0	24	148	126.0	32	27	48.0	38.0	17Hex	18.0	46.0
20-2	FG-4H-1F	411.0	14	52.0	31	202	126.0	38	34	52.0	38.0	17Hex	31.0	58.5
20-2	FG-4H-2F	419.0	14	60.0	31	202	126.0	38	34	52.0	38.0	21Hex	31.0	58.5
20-3	FG-5H-1M	506.0	14	58.0	31	210	207.0	38	34	58.0	38.0	21Hex	27.0	72.0
20-3	FG-5H-2M	511.0	23	63.0	31	210	207.0	38	34	58.0	38.0	26Hex	27.0	72.0
20-3	FG-6H-1M	531.0	23	76.0	31	210	214.0	38	36	64.0	38.0	26Hex	34.0	84.7
20-3	FG-8H-1M	557.0	23	78.0	30	232	217.0	52	40	80.0	38.0	26Hex	38.0	111.2
20-3	FG-8H-2M	557.0	23	78.0	30	232	217.0	52	40	80.0	38.0	26Hex	34.8	99.7

Grip Handle Models

Fig No.	Model	a	b1	b	c1	c2	d	e1	e2	e3	k	l	m	o	p
20-4	FG-8H-1C	538.0	23	78.0	30	232	198.0	52	40	80.0	26Hex	38.0	111.2	57	124

EXTENDED GRINDERS

Roll Handle Models

Fig No.	Model	a	b1	b	c3	c1	c2	d	e1	e2	e3	e4	k	l	m
23-1	FG-50L-1	307.5	8	36.0	91	29	103.5	48	23	39.5	36.0	37	17Hex	22.0	32.0
23-1	FG-50Y-1	523.0	8	36.5	306	29	103.5	48	23	39.5	36.0	37	17Hex	22.0	32.0
23-1	FG-3HL-1	522.0	14	43.0	252	21	105.0	101	23	40.0	48.0	32	17Hex	22.5	40.5
Fig No.	Model	a	b1	b	c1	c2	d	e1	e2	e3	e4	k	l	m	
20-1	FG-4HL-1	585.0	14	50.0	22	415	98.0	27	34	52.0	38.5	17Hex	30	45.5	
20-1	FG-5HL-2	953.0	14	63.0	24	760	106.0	36	34	58.0	38.5	17Hex	31	58.5	

Dimensions

Abrasive Tools

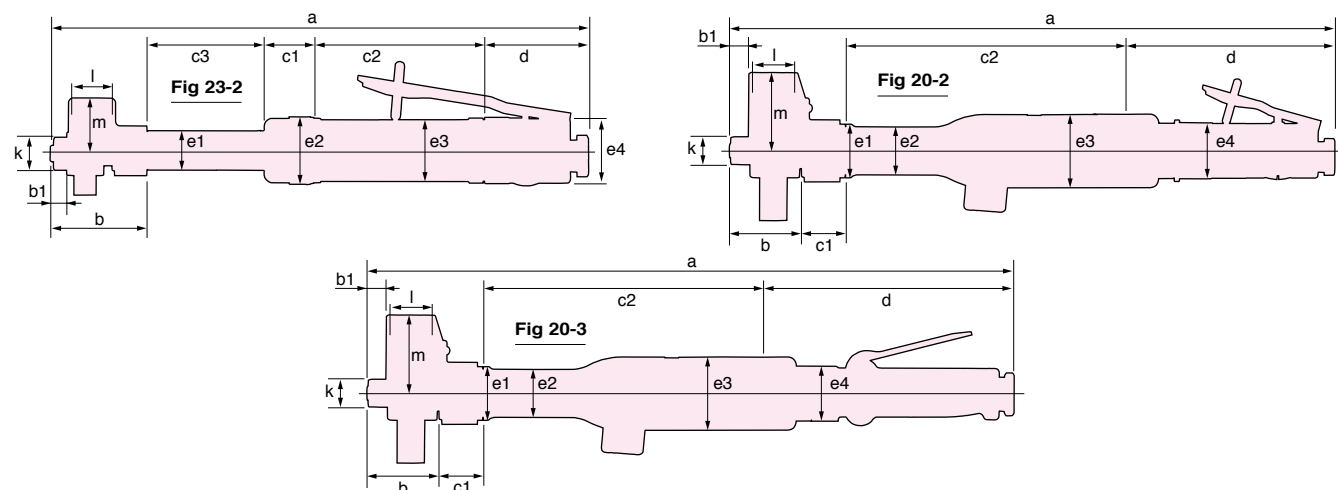

Locking Lever Handle Models

Fig No.	Model	a	b1	b	c3	c1	c2	d	e1	e2	e3	e4	k	l	m
23-2	FG-50L-1BF	316.5	8	36.0	91	29	103.5	57	23	39.5	36	39	17Hex	22.0	32.0
23-2	FG-50Y-1BF	532.0	8	36.5	306	29	103.5	57	23	39.5	36	39	17Hex	22.0	32.0
23-2	FG-3HL-1F	547.0	14	43.0	252	21	105.0	126	23	40.0	48	38	17Hex	22.5	40.5
Fig No.	Model	a	b1	b	c1	c2	d	e1	e2	e3	e4	k	l	m	
20-2	FG-4HL-1F	613.0	14	50.0	22	415	126.0	27	34	52.0	38	17Hex	33	45.5	
20-3	FG-5HL-2M	1055.0	14	63.0	24	760	208.0	36	34	58.0	38	21Hex	31	58.5	

Fig 24-1

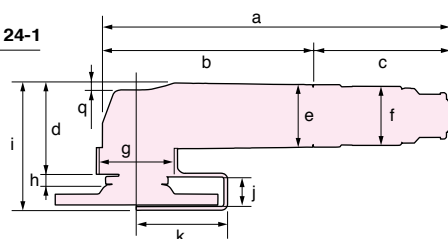
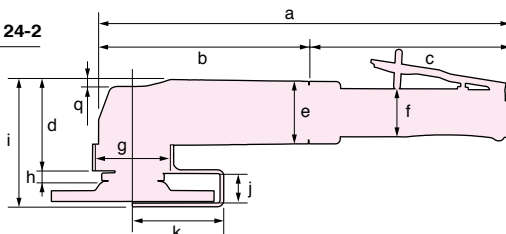

Fig 24-2



ANGLE GRINDERS

Roll Handle Models

Fig No.	Model	a	b	c	d	e	f	g	h	i	j	k
24-1	FA-2C-1	157.0	110.0	47.0	42.5	35	33.0	35	5	59.5	18.8	33.6
24-1	FA-3C-1	180.0	116.0	64.0	56.0	38	33.0	45	7	76.2	17.0	46.1
24-1	FA-3C-2	180.0	116.0	64.0	56.0	38	33.0	45	7	78.2	19.0	57.6
24-1	FA-2CX-1	197.0	109.0	88.0	42.5	35	30.5	35	5	59.5	18.8	33.6
24-1	FA-3CX-1	217.0	132.5	84.5	56.0	40	36.0	45	7	76.2	17.0	46.1
24-1	FA-3CX-2	217.0	132.5	84.5	56.0	40	36.0	45	7	78.2	19.0	57.6

Locking Lever Handle Models

Fig No.	Model	a	b	c	d	e	f	g	h	i	j	k
24-2	FA-2C-1BF	190.0	111.0	79.0	42.5	35	35	35	5	59.5	18.8	33.6
24-2	FA-3C-1F	192.5	116.5	76.0	56.0	38	35	45	7	76.2	17.0	46.1
24-2	FA-3C-2F	192.5	116.5	76.0	56.0	38	35	45	7	78.2	19.0	57.6
24-2	FA-2CX-1BF	226.0	109.0	117.0	42.5	35	35	35	5	59.5	18.8	33.6
24-2	FA-3CX-1F	247.0	133.0	114.0	56.0	40	35	45	8	76.2	17.0	46.1
24-2	FA-3CX-2F	247.0	133.0	114.0	56.0	40	35	45	7	78.2	19.0	57.6

Roll Handle Models

Fig No.	Model	a	b	c	d	e	f	g	h	i	j	k	q
24-1	FA-4C-1	212.0	111.0	101.0	69.0	48	32	52	8	95.0	14.8	57.6	-
24-1	FA-4CH-1	217.0	131.0	86.0	68.6	48	37	52	8	93.5	14.8	57.6	-
24-1	FA-5E-1V	210.5	110.5	100.0	61.5	52	36	45	13	90.7	18.5	72.6	4.5
24-1	FA-5E-2V	210.5	110.5	100.0	61.5	52	36	45	13	90.7	18.5	72.6	4.5
24-1	FA-5E-3V	210.5	110.5	100.0	61.5	52	36	45	13	90.2	19.0	57.6	4.5

Locking Lever Handle Models

Fig No.	Model	a	b	c	d	e	f	g	h	i	j	k	q
24-2	FA-4C-1F	237.0	111.0	126.0	69.0	48	38	52	8	95.0	14.8	57.6	-
24-2	FA-5E-1F	279.5	110.5	169.0	61.5	52	40	45	13	90.7	18.5	72.6	4.5
24-2	FA-5E-1VF	260.5	110.5	150.0	61.5	52	40	45	13	90.7	18.5	72.6	4.5
24-2	FA-5E-2F	279.5	110.5	169.0	61.5	52	40	45	13	90.7	18.5	72.6	4.5
24-2	FA-5E-2VF	260.5	110.5	150.0	61.5	52	40	45	13	90.7	18.5	72.6	4.5
24-2	FA-5E-13F	279.5	110.5	169.0	61.5	52	40	45	13	90.7	18.5	72.6	4.5
24-2	FA-5E-13VF	260.5	110.5	150.0	61.5	52	40	45	13	90.7	18.5	72.6	4.5

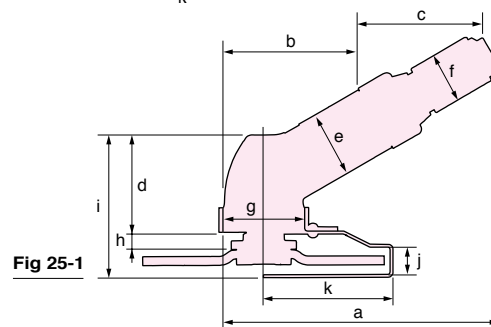
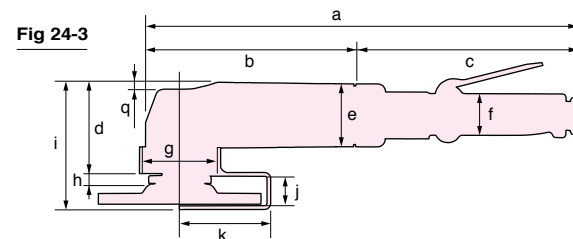
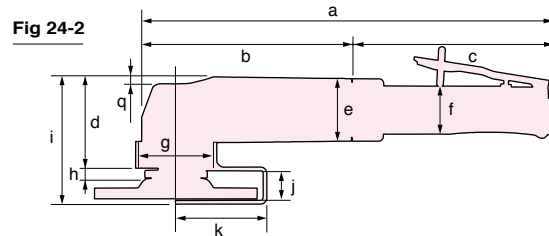
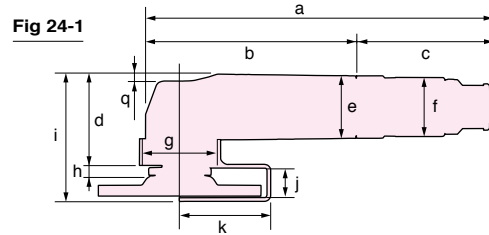

Roll Handle Models

Fig No.	Model	a	b	c	d	e	f	g	h	i	j	k	q
24-1	FA-6C-10	252.0	146.0	106.0	74.0	56	38	60	15.0	108.0	20.8	96.6	-
24-1	FA-6C-1	252.0	146.0	106.0	74.0	56	38	60	15.0	108.0	20.8	96.6	-
24-1	FA-6C-12	252.0	146.0	106.0	74.0	56	38	60	15.0	108.0	20.8	96.6	-
24-1	FA-7E-1V	266.0	145.5	120.5	75.6	62	42	60	17.0	110.5	21.0	100.5	6
24-1	FA-7E-2V	266.0	145.5	120.5	75.6	62	42	60	17.0	110.5	21.0	100.5	6
24-1	FA-7E-3V	266.0	145.5	120.5	75.6	62	42	60	17.0	109.5	19.0	100.5	6

Locking Lever Handle Models

Fig No.	Model	a	b	c	d	e	f	g	h	i	j	k	q
24-3	FA-6C-12M	353.0	146.0	207.0	74.0	56	38	60	15.0	108.0	20.8	96.6	-
24-3	FA-6C-9M	353.0	146.0	207.0	74.0	56	38	60	32.0	126.0	25.8	98.0	-
24-3	FA-6C-8M	353.0	146.0	207.0	74.0	56	38	60	32.0	126.0	25.8	98.0	-
24-3	FA-6C-6M	353.0	146.0	207.0	74.0	56	38	60	32.0	126.0	25.8	98.0	-
24-2	FA-7E-5VF	307.0	145.5	161.5	75.6	62	40	60	26.2	120.5	21.0	100.5	6
24-2	FA-7E-6VF	307.0	145.5	161.5	75.6	62	40	60	26.2	120.5	21.0	100.5	6
24-2	FA-7E-8VF	307.0	145.5	161.5	75.6	62	40	60	26.2	120.5	21.0	100.5	6

Roll Handle Models

Fig No.	Model	a	b	c	d	e	f	g	h	i	j	k
24-1	FA-9C-2	306.0	167.0	139.0	80.0	72.0	42.0	60	15.0	117.4	21.0	122.0
24-1	FA-9C-4	306.0	167.0	139.0	80.0	72.0	42.0	60	32.0	137.4	30.0	122.0

Locking Lever Handle Models

Fig No.	Model	a	b	c	d	e	f	g	h	i	j	k
24-3	FA-9C-2M	380.0	167.0	213.0	80.0	72.0	38.0	60	15.0	117.4	21.0	122.0
24-3	FA-9C-4M	380.0	167.0	213.0	80.0	72.0	38.0	60	32.0	137.4	30.0	122.0

Roll Handle Models(110°, 120°)

Fig No.	Model	a	b	c	d	e	f	g	h	i	j	k
25-1	FA-3CK-2	164.0	95.0	70.0	63.0	40.0	33.0	45	14.5	95.0	23.8	57.6
25-1	FA-4CHK-1	206.0	129.0	77.0	69.6	48.0	37.0	52	10.0	95.0	14.8	57.6
25-1	FA-150KG-5	206.0	127.0	79.0	72.0	50.0	36.0	60	15.0	107.0	20.8	96.6

Dimensions

Abrasive Tools

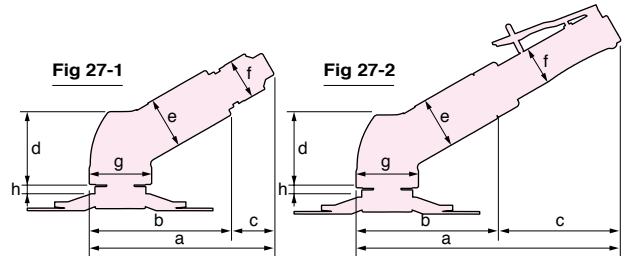
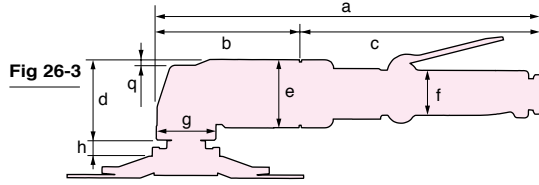
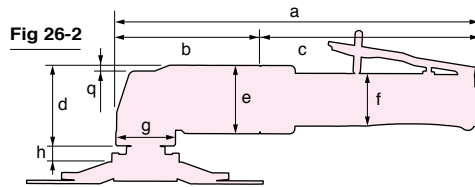
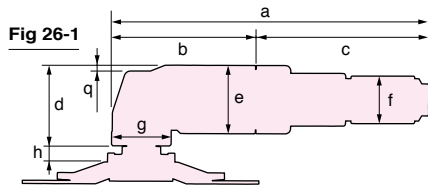

ANGLE SANDERS

Roll Handle Models

Fig No.	Model	a	b	c	d	e	f	g	h	q
26-1	FA-5C-5	227.0	131.0	96.0	71.0	52.0	36.0	57	13.0	4.0
26-1	FA-6C-10	252.0	146.0	106.0	74.0	56.0	38.0	60	15.0	-
26-1	FA-5E-7V	210.5	110.5	100.0	61.5	52.0	36.0	45	13.0	4.5

Locking Lever Handle Models

Fig No.	Model	a	b	c	d	e	f	g	h	q
26-3	FA-6C-10M	353.0	146.0	207.0	74.0	56.0	38.0	60	15.0	-
26-2	FA-5E-6VF	260.5	110.5	150.0	61.5	52.0	40.0	45	13.0	4.5
26-3	FA-6C-9M	353.0	146.0	207.0	74.0	56.0	38.0	60	32.0	-
26-2	FA-7E-5VF	307.0	145.5	161.5	75.6	62.0	40.0	60	26.2	6.0

Roll Handle Models(110°, 120°)

Fig No.	Model	a	b	c	d	e	f	g	h
27-1	FA-4CHK-3	206.0	129.0	77.0	70.0	48.0	37.0	52	8.6
27-1	FA-150K-2	179.0	137.0	42.0	71.6	60.0	39.5	60	9.0
27-1	FA-150K-3	179.0	137.0	42.0	71.6	50.0	39.5	60	9.0
27-1	FA-150KG-7	206.0	127.0	79.0	72.0	50.0	36.0	60	15.0
27-1	FA-3CK-1	164.0	113.0	51.0	61.0	40.0	33.0	45	18.0

Locking Lever Handle Models(110°, 120°)

Fig No.	Model	a	b	c	d	e	f	g	h
27-2	FA-4CHK-3F	235.0	129.0	106.0	70.0	48.0	38.0	52	8.6

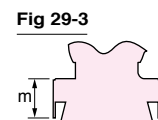
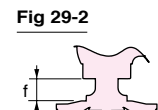
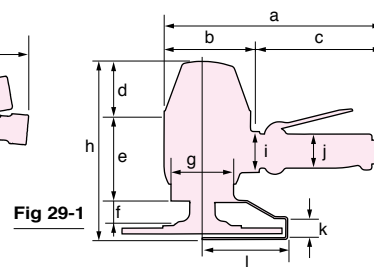
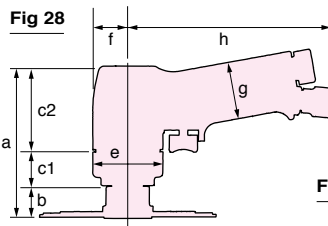
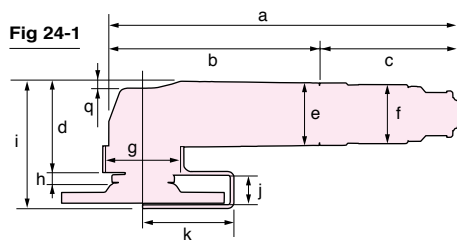

ANGLE CUTTERS

Fig No.	Model	a	b	c	d	e	f	g	h	i	j	k	q
24-1	FA-5E-8V	210.5	110.5	100.0	61.5	52.0	36.0	45	17.0	90.7	18.5	72.6	4.5
24-1	FA-6C-20	252.0	146.0	106.0	74.0	56.0	38.0	60	18.0	103.0	27.4	84.1	-
24-1	FA-7C-21	264.0	143.5	120.5	73.6	63.0	42.0	60	18.0	108.0	20.8	96.6	-

DISC SANDER

Fig No.	Model	a	b	c1	c2	e	f	g	h
28	FG-5PX-1	108.0	21.0	24.0	63.0	50.0	25.0	41	147.0

VERTICAL GRINDERS

Standard Type

Fig No.	Model	a	b	c	d	e	f	g	h	i	j	k	l
29-1	FV-7-1M	247.0	100.0	147.0	63.0	94.4	26.2	64	201.0	46	38	22.0	96.6
29-1	FV-7-4M	247.0	100.0	147.0	63.0	94.4	26.2	64	201.0	46	38	22.0	96.6
29-1	FV-9BH-1M	266.0	127.5	138.5	69.0	119.0	50.2	69	238.2	46	38	30.0	122.0

Cup Wheel Type

Fig No.	Model	a	b	c	d	e	f	g	h	i	j	l	m
29-3	FV-9BH-4M	266.0	127.5	138.5	69.0	119.0	76	69	264.0	46	38	88.4	56-85

Sanding Disc Type

Fig No.	Model	a	b	c	d	e	f	g	i	j
29-2	FV-7-2M	247.0	100.0	147.0	63.0	94.4	38	64	46	38

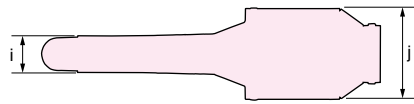
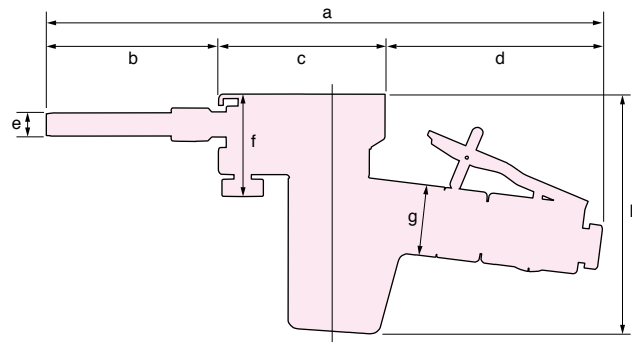

Fig 30



BELT SANDERS

Fig No.	Model	a	b	c	d	e	f	g	h	i	j
30	FBS-1-1	281	87	84	110	10	51	35	121	18	45.2
30	FBS-1-2	375	181	84	110	20	51	35	121	22	45.2
30	FBS-1-3	345	151	84	110	13	51	35	121	18	45.2
30	FBS-1-4	345	151	84	110	20	51	35	121	22	45.2

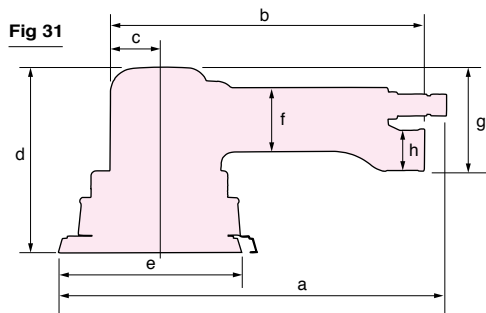

Fig 31

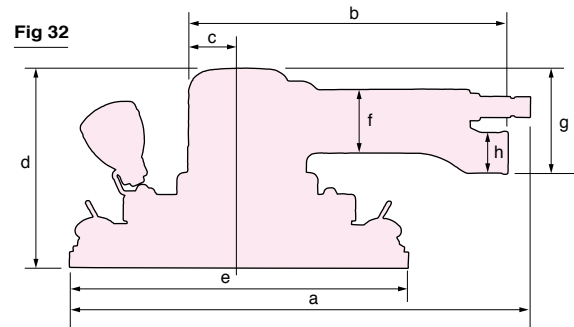

Fig 32

ORBITAL SANDERS

Cock Handle Models

Fig No.	Model	a	b	c	d	e	f	g	h
31	DA-125T-E(-M)	172	142	33	89	125	-	41	26
31	FOR-125T-E(-M)	259	216	35	122	125	42	69	26
31	FOR-150T-E(-M)	276	124	35	122	150	42	68	26

Lever Handle Models

Fig No.	Model	a	b	c	d	e	f	g	h
31	DA-125L-E(-M)	172	142	33	97	125	-	45	26
31	DA-125C-E(-M)	172	142	33	117	125	-	45	26
31	FOR-125B-E(-M)	259	216	35	122	125	42	69	26
31	FOR-150B-E(-M)	276	124	35	122	150	42	68	26

Locking Lever Handle Models

Fig No.	Model	a	b	c	d	e	f	g	h
31	FOR-125BF-E(-M)	259	216	35	122	125	42	69	26
31	FOR-150BF-E(-M)	276	124	35	122	150	42	68	26

Cock Handle Models

Fig No.	Model	a	b	c	d	e	f	g	h
32	OB-75T-E(-M)	160	125	31	88	75X100	-	46	26
32	FOS-175T-E(-M)	285	216	35	130	100X175	42	69	26
32	FOS-230T-E	312	217	35	132	100X230	42	68	26
32	FOS-400T-E	400	211	32	138	100X400	43	66	26

Lever Handle Models

Fig No.	Model	a	b	c	d	e	f	g	h
32	OB-75L-E(-M)	160	125	31	99	75X100	-	57	26
32	OB-90L-E(-M)	160	125	31	99	90X100	-	57	26
32	FOS-175B-E(-M)	285	216	35	130	100X175	42	69	26
32	FOS-230B-E	312	217	35	132	100X230	42	68	26
32	FOS-400B-E	400	211	32	138	100X400	43	66	26

Locking Lever Handle Models

Fig No.	Model	a	b	c	d	e	f	g	h
32	FOS-175BF-E(-M)	285	216	35	130	100X175	42	69	26
32	FOS-230BF-E	312	217	35	132	100X230	42	68	26
32	FOS-400BF-E	400	211	32	138	100X400	43	66	26

Dimensions

Drills / Tappers

Fig 33

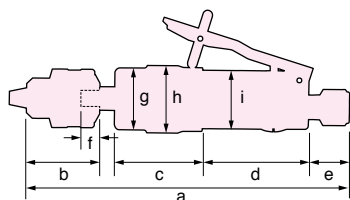
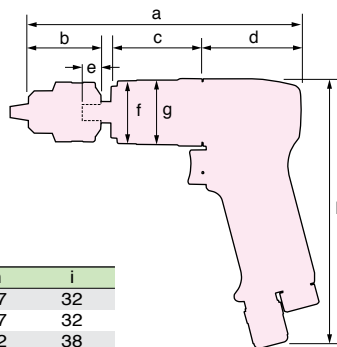

Fig 34-1



DRILLS

Straight / Side Exhaust Type

Fig No.	Model	a	b	c	d	e	f	g	h	i
33	FRD-5S-1(F)	179	40	49	58.5	22.5	12	34	37	32
33	FRD-5S-2T(F)	168	32	49	58.5	22.5	12	34	37	32
33	FRD-6S-2(F)	209	40	57	82.5	22.5	12	39	42	38
33	FRD-6S-3(F)	212	43	57	82.5	22.5	12	39	42	38
33	FRD-6S-5(F)	230	51	69	82.5	22.5	12	41	46	38
33	FRD-6S-7(F)	265	64	91	82.5	22.5	15	32	42	38

Pistol / Rear Exhaust Type

Fig No.	Model	a	b	c	d	e	f	g	h
34-1	FRD-5P-1	155	40	46.5	60.5	12	34	35	159
34-1	FRD-6PX-2	166	40	57.0	62.0	12	39	40	165
34-1	FRD-6PX-3	169	43	57.0	62.0	12	39	40	165
34-1	FRD-6PX-5	187	51	69.0	62.0	12	41	45	165
34-1	FRD-6PX-7	222	64	91.0	62.0	15	32	38	165
34-1	FRD-8PX-1	187	43	62.0	75.0	12	40	45	191
34-1	FRD-8PX-2	210	51	77.0	75.0	12	40	52	191
34-1	FRD-8PX-3	240	64	95.0	75.0	15	48	51	191

Fig 35-1

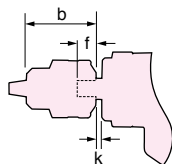
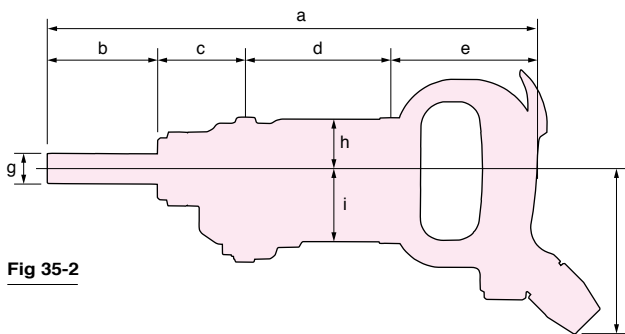

Fig 35-2



Grip Handle Middle Size Drills

Fig No.	Model	a	b	c	d	e	f	k	g	h	i	j
35-1	FRD-12Z-1(C)	349	51	58	96	97	15	5	-	33	47	108
35-1	FRD-16Z-1(C)	374	73	58	96	97	20	8	-	33	47	108

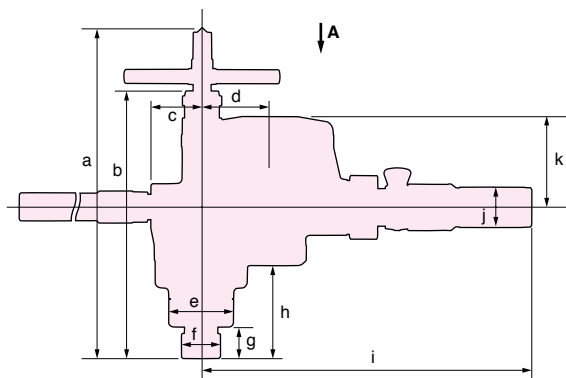
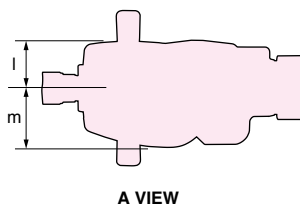

Fig 36



Heavy -Duty Rotary Drills

Fig No.	Model	a	b	c	d	e	f	g	h	i	j	k	l	m
36	FRD-20R-21(S)	278.5~345.5	220.5	37	56.7	52	26	15.6	85.6	300.7	38	75.9	39	39
36	FRD-20R-22(S)	305~372	247.0	37	56.7	48	32	27.1	112.1	300.7	38	75.9	39	39
36	FRD-23R-21(S)	278.5~345.5	220.5	37	56.7	52	26	15.6	85.6	300.7	38	75.9	39	39
36	FRD-23R-22(S)	305~372	247.0	37	56.7	48	32	27.1	112.1	300.7	38	75.9	39	39
36	FRD-25R-11(S)	354.4~450.4	293.4	55	75.0	70	42	34.6	102.6	364.0	43	99.4	51	65
36	FRD-28R-11(S)	354.4~450.4	293.4	55	75.0	70	42	34.6	102.6	364.0	43	99.4	51	65
36	FRD-32R-11(S)	354.4~450.4	293.4	55	75.0	70	42	34.6	102.6	364.0	43	99.4	51	65
36	FRD-32R-12(S)	382.4~478.4	321.4	55	75.0	70	49	62.6	130.6	364.0	43	99.4	51	65
36	FRD-40R-11(S)	446.4~539.4	385.4	55	75.0	78	52	41.6	195.1	364.0	43	99.4	65	65
36	FRD-50R-11(S)	446.4~539.4	385.4	55	75.0	78	52	41.6	195.1	364.0	43	99.4	65	65
36	FRD-65R-1	466~591	391.0	82	121.7	87	70	46.0	141.0	572.0	48	122.0	68	68
36	FRD-65R-1S	466~591	391.0	82	121.7	87	70	46.0	141.0	552.0	43	122.0	68	68
36	FRD-75R-1	600~728	525.0	82	121.7	87	70	67.0	165.0	572.0	48	122.0	68	68
36	FRD-75R-1S	600~728	525.0	82	121.7	87	70	67.0	165.0	552.0	43	122.0	68	68
36	FRD-100R-1	600~728	525.0	82	121.7	87	70	67.0	165.0	572.0	48	122.0	68	68
36	FRD-100R-1S	600~728	525.0	82	121.7	87	70	67.0	165.0	552.0	43	122.0	68	68

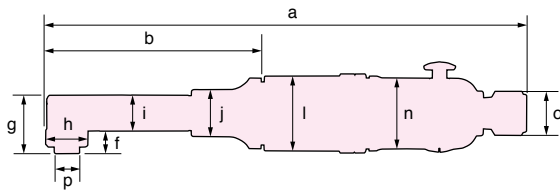

Fig 37

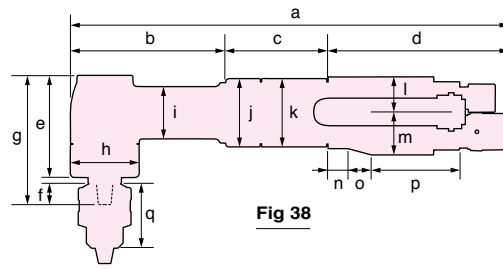

Fig 38

BABY ANGLE DRILLS

Fig No.	Model	a	b	f	g	h	i	j	l	n	o	p
37	FCD-6A-1	223	99.5	10.5	26.5	19	16	21	34	32	19.6	9.5Hex
37	FCD-6B-1(F)	222	99.5	10.5	26.5	19	16	21	34	32	19.6	9.5Hex
37	FCD-6EX-3	246	94.0	7.0	27.0	17	17	22	38	35	27.0	-
37	FCD-6EX-4	246	94.0	7.0	27.0	17	17	22	38	35	27.0	-

CORNER DRILLS

Fig No.	Model	a	b	c	d	e	f	g	h	i	j	k	l	m	n	o	p	q
38	FCD-6X-1(F)	273	97	64	112	63	12	79	42	32	42	42	22.0	26.0	12	15	54	40
38	FCD-6X-2(F)	286	97	77	112	63	12	79	42	32	42	44	22.0	26.0	12	15	54	43
38	FCD-10X-1(F)	377	93	60	224	62	14	82	42	36	46	50	24.5	17.5	82	10	84	51

Fig 39

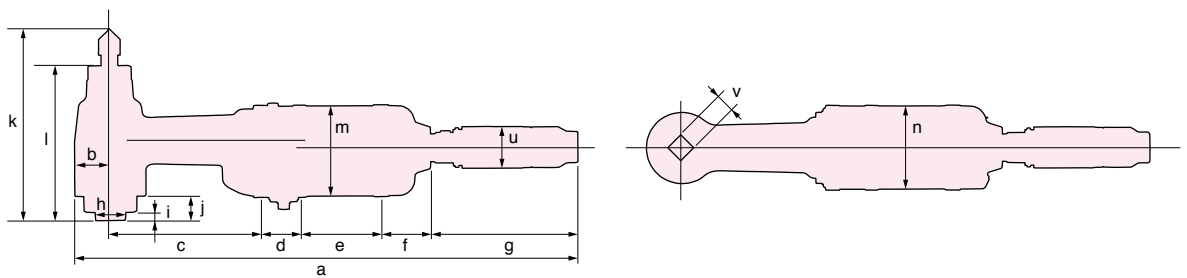

Heavy-Duty Corner Drills

Fig No.	Model	a	b	c	d	e	f	g	h	i	j	k	l	m	n	u	v
39	F-14CN	412	24	150	20	70	55	93	22	6.0	21.0	135.0~173.0	110.0	71.7	62	38	□ 16
39	F-14CN-1S	414	24	150	20	70	55	95	22	6.0	21.0	135.0~173.0	110.0	71.7	62	40	□ 16
39	F-14CN-2	412	24	150	20	70	55	93	29	16.5	33.5	147.5~185.5	122.5	71.7	62	38	□ 16
39	F-14CN-2S	414	24	150	20	70	55	93	29	16.5	33.5	147.5~185.5	122.5	71.7	62	40	□ 16
39	F-22RCN	499	35	150	39	79	50	146	29	8.0	24.0	177.0~237.0	152.0	88.0	82	40	□ 16
39	F-22RCN-1S	499	35	150	39	79	50	146	29	8.0	24.0	177.0~237.0	152.0	88.0	82	38	□ 16
39	F-32RCN	529	40	175	39	79	50	146	34	11.0	21.0	195.0~255.0	170.0	88.0	82	40	□ 16
39	F-32RCN-1S	529	40	175	39	79	50	146	34	11.0	21.0	195.0~255.0	170.0	88.0	82	38	□ 16
39	F-32RCNS	529	40	175	39	79	50	146	35	1.0	9.0	126.0~151.0	107.0	88.0	82	40	□ 14
39	F-32RCNS-1S	529	40	175	39	79	50	146	35	1.0	9.0	126.0~151.0	107.0	88.0	82	38	□ 14
39	F-22RCR	507	35	150	39	79	50	154	29	8.0	24.0	177.0~237.0	152.0	88.0	82	40	□ 16
39	F-22RCR-1S	528	35	150	39	79	50	175	29	8.0	24.0	177.0~237.0	152.0	88.0	82	38	□ 16
39	F-32RCR	538	40	175	39	79	50	155	34	11.0	21.0	195.0~255.0	170.0	88.0	82	40	□ 16
39	F-32RCR-1S	558	40	175	39	79	50	175	34	11.0	21.0	195.0~255.0	170.0	88.0	82	38	□ 16
39	FCD-23R-11(S)	473	27	96	39	80	60	172	27	5.5	15.5	151.5~186.5	126.5	91.5	81	38	□ 16
39	FCD-23R-12(S)	473	27	96	39	80	60	172	31	14.5	37.5	172.5~207.5	147.5	91.5	81	38	□ 16
39	FCD-32R-11	579	35	118	50	101	75	200	34	10.0	26.0	194.0~247.0	164.0	110.0	96	43	□ 16
39	FCD-32R-11S	579	35	118	50	101	72	203	35	10.0	26.0	194.0~247.0	164.0	110.0	96	43	□ 16
39	FCD-50R-11(S)	596	42	128	50	101	75	200	44	16.0	38.0	230.0~288.0	191.0	110.0	96	43	□ 22.2
39	FCD-75R-11(S)	652	49	157	50	121	75	200	60	18.0	48.0	272.0~329.0	227.0	110.0	96	43	□ 25.4
39	FCD-100R-11(S)	729	62	241	50	101	75	200	60	38.0	75.0	306.0~411.0	285.0	110.0	96	43	□ 23

Fig 34-1

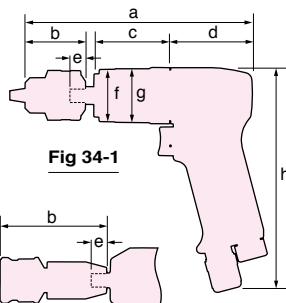

Fig 34-2

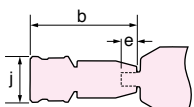
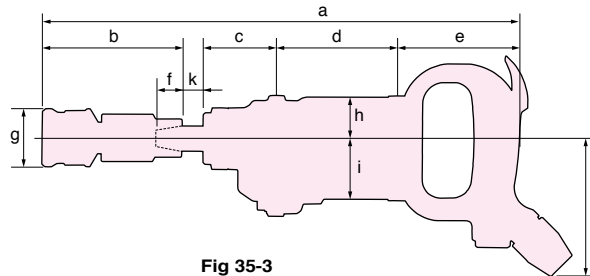

Fig 35-3



TAPPERS

Fig No.	Model	a	b	c	d	e	f	g	h	j		
34-1	FT-6P-1	236	45	112	63.5	15	38	45	154.0	-		
34-1	FT-6BX-1D	206	40	34	128.0	15	46	47	143.5	-		
34-2	FT-6BX-1T	241	75	34	128.0	15	46	47	143.5	32		
34-2	FT-8PX-1	232	78	27	121.0	14	46	45	193.0	32		
Fig No.	Model	a	b	c	d	e	f	g	h	i	j	k
35-3	FT-13Z-1	427	70	92	108	97	20	45	37	65	108	18

Dimensions

Percussive Tools

Fig 41

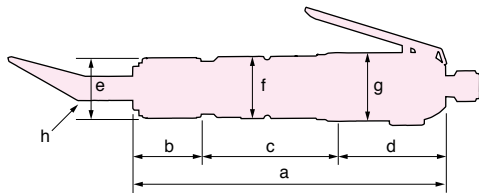

FLUX CHIPPERS

Fig No.	Model	a	b	c	d	e	f	g	h
41	FCH-20	176	66	52	58	33	32	36	□9.0
41	FCH-20-1F	176	66	52	58	33	32	36	□9.0
41	FCH-20F	182	42	82	58	39	32	36	□12.7
41	FCH-20F-1F	182	42	82	58	39	32	36	□12.7
41	FCH-25	204	44	92	68	39	40	44	□12.7
41	FCH-25-1F	204	44	92	68	39	40	44	□12.7
41	FCH-25B	239	44	92	103	39	40	44	□12.7
41	FCH-25B-1F	239	44	92	103	39	40	44	□12.7

Fig 42

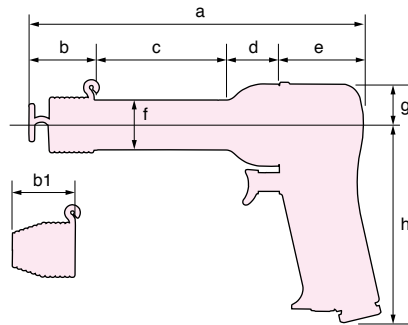
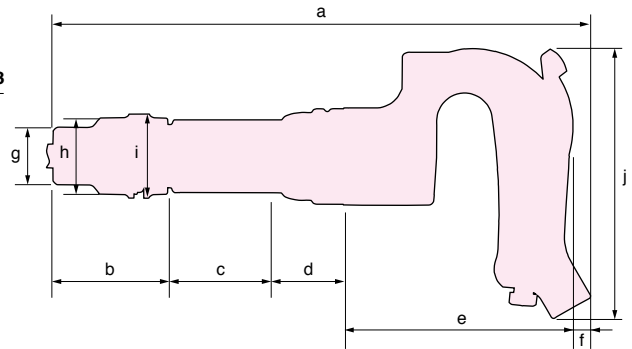

Fig 43



LIGHT HAMMERS

Fig No.	Model	a	b	c	d	e	f	g	h	b1
42	FRH-3-1	140	39.5	10	38	52.5	30	25	121	38
42	FRH-3-2	140	39.5	10	38	52.5	30	25	121	38
42	FRH-6-1	206	39.5	76	38	52.5	30	25	121	38
42	FRH-6-2	206	39.5	76	38	52.5	30	25	121	38
42	FRH-6A-1	193	42.0	63	36	52.0	36	25	121	36
42	FRH-6A-2	193	42.0	63	36	52.0	36	25	121	36

CHIPPING & CALKING HAMMERS

Fig No.	Model	a	b	c	d	e	f	g	h	i	j
43	FC-01SA-H	281.0	49.0	65	37.0	119	11	23	39	53	142
43	FC-01SA-R	281.0	49.0	65	37.0	119	11	23	39	53	142
43	FC-01-3	284.0	60.0	57	37.0	119	11	30	40	44	142
43	FC-01-4	284.0	60.0	57	37.0	119	11	30	40	44	142
43	FC-1Z-1	343.5	79.5	54	39.5	147	23	46	59	63	158
43	FC-1Z-2	343.5	79.5	54	39.5	147	23	46	59	63	158
43	FC-2Z-1	384.5	79.5	95	39.5	147	23	46	59	63	158
43	FC-2Z-2	384.5	79.5	95	39.5	147	23	46	59	63	158
43	FC-3Z-1	428.5	79.5	139	39.5	147	23	46	59	63	158
43	FC-3Z-2	428.5	79.5	139	39.5	147	23	46	59	63	158
43	FC-4Z-1	467.5	79.5	178	39.5	147	23	46	59	63	158
43	FC-4Z-2	467.5	79.5	178	39.5	147	23	46	59	63	158

Fig 44

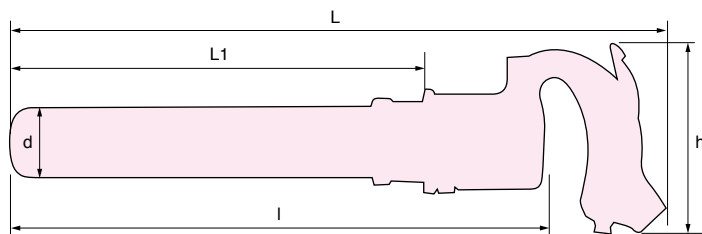

Fig 45-1

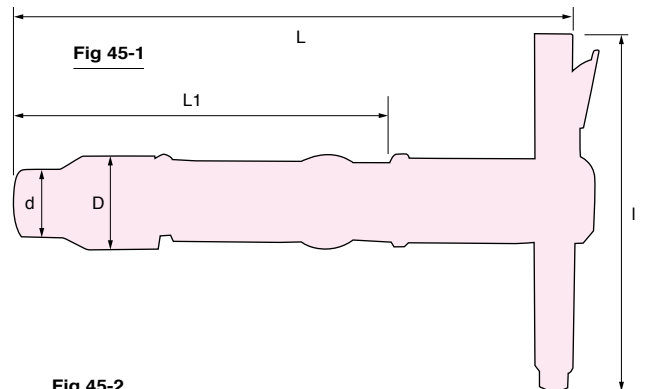
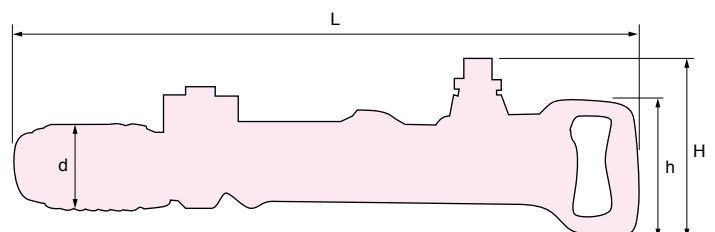

Fig 45-2



RIVETING HAMMERS

Fig No.	Model	L	L1	l	h	d
44	B-40	400	205	300	156	61
44	B-50	425	230	325	156	61
44	B-60	450	255	350	156	61
44	B-80	500	305	400	156	61
44	B-90	525	330	425	156	61

CONCRETE BREAKERS

Fig No.	Model	L	L1	l	d	D
45-1	CB-10	490	320	435	65	80
45-1	CB-20	570	365	365	69	95
45-1	CB-30	620	415	365	73	119
Fig No.	Model	L	H	h	d	
45-2	CA-7	465	125	115	60	

Fig 46-1

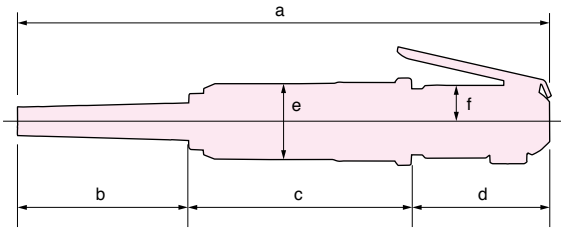
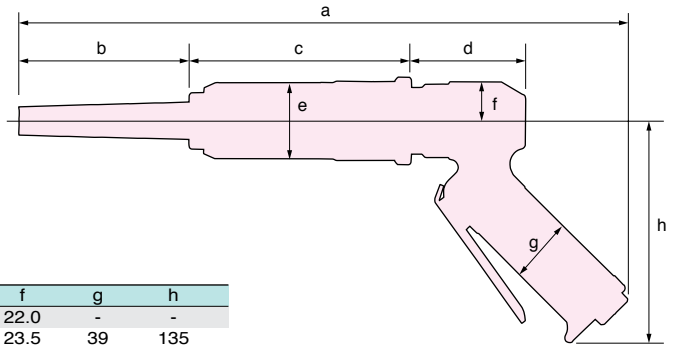

Fig 46-2



NEEDLE SCALERS

Fig No.	Model	a	b	c	d	e	f	g	h
46-1	FNS-2(-1F)	325	104	136	85	46	22.0	-	-
46-2	FNS-2P(-1F)	372	104	136	70	46	23.5	39	135

Fig 47-1

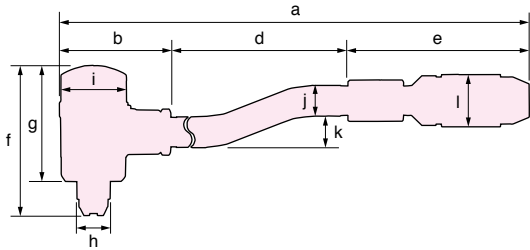
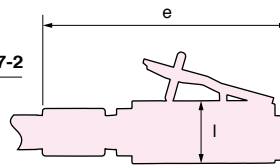

Fig 47-2



SCALING HAMMERS

Fig No.	Model	a	b	c	d	e	f	g	h	i	j	k	l	m	n
47-1	FS-2A	510	82	-	295	133	110~94	85	21	50	22	23	38	-	-
47-1	FS-2A-1F	535	82	-	295	158	110~94	85	21	50	22	23	40	-	-

Fig 48-1

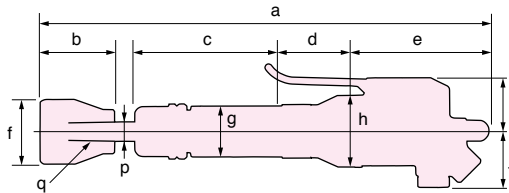
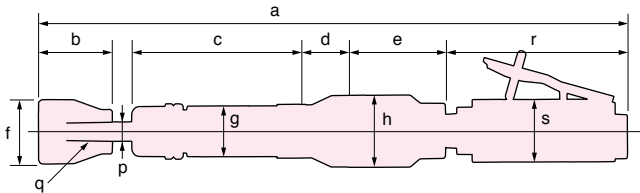

Fig 48-2



SAND RAMMERS

Fig No.	Model	a	b	c	d	e	f	r	g	h	s	i	j	p	q
48-1	FR-18B	287~337	47	114	28	85	41	-	32	46	-	34	36	12.0	taper 1:20
48-1	FR-22B	364~428	60	154	35	85	51	-	38	50	-	38	36	14.0	taper 1:20
48-1	FR-25B	539~622	80	228	49	117	67	-	46	60	-	47	32	17.5	taper 1:20
48-2	FR-18B-2F	390~440	47	114	28	63	41	118	32	46	40	-	-	12.0	taper 1:20
48-2	FR-22B-2F	465~529	60	154	35	68	51	118	38	50	40	-	-	14.0	taper 1:20
48-2	FR-25B-2F	630~713	80	228	49	90	67	118	46	60	40	-	-	17.5	taper 1:20

Fig 48-3

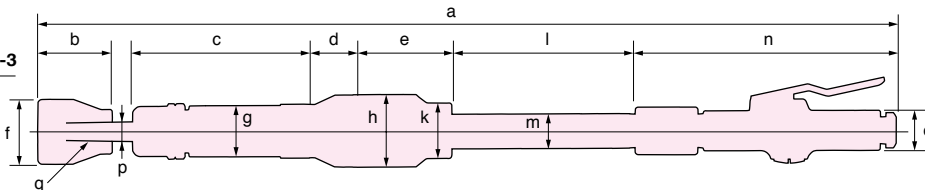

Fig 48-4

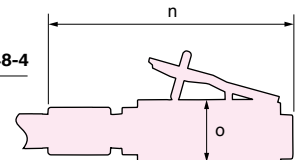

Fig No.	Model	a	b	c	d	e	f	g	h	k	l	m	n	o	p	q
48-3	FR-18L	565~615	47	113	28	64.0	41	32	46	35	124	21.7	167	25	12.0	taper 1:20
48-3	FR-22L	647~711	60	154	35	68.0	51	38	50	35	124	21.7	173	25	14.0	taper 1:20
48-3	FR-25L	1076~1159	80	228	49	90.0	67	46	60	45	400	21.7	169	32	17.5	taper 1:20
48-3	FR-32	1119~1246	92	262	60	85.0	75	53	68	50	395	27.5	154	32	19.0	taper 1:20
48-4	FR-18L-2F	542~592	60	113	28	64.0	51	32	46	35	124	21.7	158	40	12.0	taper 1:20
48-4	FR-22L-2F	614~678	60	154	35	68.0	51	38	50	35	124	21.7	158	40	14.0	taper 1:20
48-4	FR-25L-2F	1038~1121	80	228	49	90.0	67	46	60	45	400	21.7	158	40	17.5	taper 1:20
48-4	FR-32-2F	1123~1250	92	260	60	85.6	75	53	68	50	401	27.5	158	40	19.0	taper 1:20

Dimensions

Air Motors

Fig 49-1

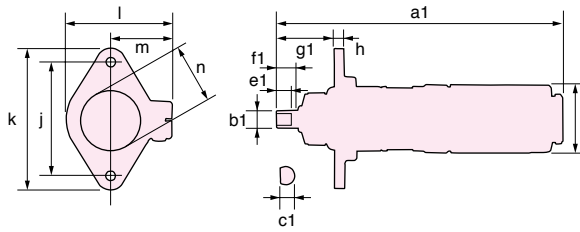
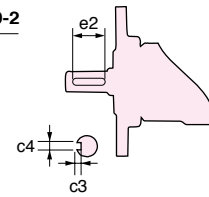

Fig 49-2



AIR MOTORS Reversible Type

Fig No.	Model	a1	b1	c1	c3	c4	e1	e2	f1	g1	h	i	j	k	l	m	n	o	r	s
49-1	F-5SM-8.5R	147	8	7.0	-	-	10	-	12	20.0	5	40	60	74	55	33	35	18	6.5	8.0
49-1	F-5SM-2R	180	8	7.0	-	-	10	-	12	25.0	5	40	60	74	55	33	35	18	6.5	8.0
49-1	F-6SM-28R	146	10	8.5	-	-	12	-	14	19.0	6	42	70	88	64	38	39	20	6.5	8.0
49-1	F-6SM-21R	146	10	8.5	-	-	12	-	14	19.0	6	42	70	88	64	38	38	20	6.5	8.0
49-1	F-6SM-12R	157	10	8.5	-	-	12	-	14	18.0	6	42	70	88	64	38	39	20	6.5	8.0
49-1	F-6SM-8R	179	10	8.5	-	-	12	-	14	36.0	6	42	70	88	64	38	39	20	6.5	8.0
49-1	F-6SM-5R	179	10	8.5	-	-	12	-	14	36.0	6	42	70	88	64	38	38	20	6.5	8.0
49-1	F-6SM-2.5R	192	10	8.5	-	-	12	-	14	36.0	6	42	70	88	64	38	38	20	6.5	8.0
49-2	F-8SM-28R	183	12	-	2.5	4.0	-	18	25	29.0	6	58	70	88	64	38	45	26	11.0	17.0
49-2	F-8SM-12R	199	12	-	2.5	4.0	-	18	25	49.0	8	58	90	114	81	48	52	26	11.0	17.0
49-2	F-8SM-8.5R	222	16	-	3.0	5.0	-	25	32	46.5	8	58	90	114	81	48	51	26	11.0	17.0

Fig 50-1

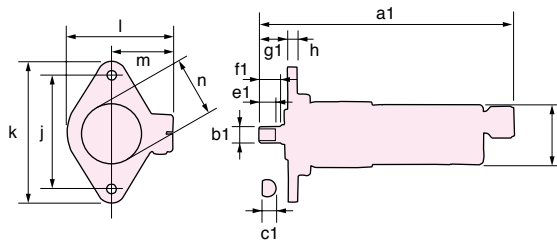

Fig 50-2

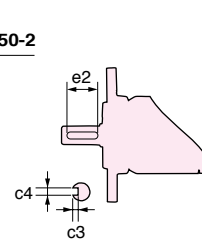
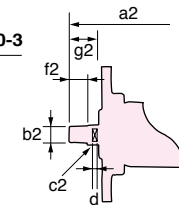

Fig 50-3



Non-reversible Type

Fig No.	Model	a1	b1	c1	c3	c4	e1	e2	f1	g1	h	i	j	k	l	m	n	a2	b2	c2	d	f2	g2	
50-1	F-5SM-8.5	152	8	7.0	-	-	10	-	12	20.0	5	32	60	74	55	33	35	-	-	-	-	-	-	-
50-1	F-5SM-2	185	8	7.0	-	-	10	-	12	25.0	5	32	60	74	55	33	35	-	-	-	-	-	-	-
50-1, 3	F-6SM-28	167	10	8.5	-	-	12	-	14	19.0	6	38	70	88	64	38	39	169	3/8-24	10	4	12	21.0	
50-1, 3	F-6SM-21	167	10	8.5	-	-	12	-	14	19.0	6	38	70	88	64	38	39	167	3/8-24	10	4	12	19.0	
50-1, 3	F-6SM-12	178	10	8.5	-	-	12	-	14	18.0	6	38	70	88	64	38	41	178	3/8-24	10	4	12	18.0	
50-1, 3	F-6SM-8	200	10	8.5	-	-	12	-	14	36.0	6	38	70	88	64	38	38	200	3/8-24	14	5	12	36.0	
50-1, 3	F-6SM-5	200	10	8.5	-	-	12	-	14	36.0	6	38	70	88	64	38	38	200	3/8-24	14	5	12	36.0	
50-1, 3	F-6SM-2.5	213	10	8.5	-	-	12	-	14	36.0	6	38	70	88	64	38	38	214	3/8-24	14	5	12	36.0	
50-2, 3	F-8SMA-28	181	12	-	2.5	4.0	-	18	25	30.0	6	50	70	88	64	38	43	173	3/8-24	12	5	12	20.0	
50-2, 3	F-8SMA-12	200	12	-	2.5	4.0	-	18	25	28.0	8	50	90	114	81	48	51	189	3/8-24	12	5	12	17.0	
50-2, 3	F-8SMA-8.5	222	16	-	3.0	5.0	-	25	32	46.5	8	50	90	114	81	48	51	208	1/2-20	14	6	15	32.5	

Fig 51

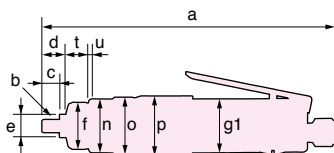

Fig 52

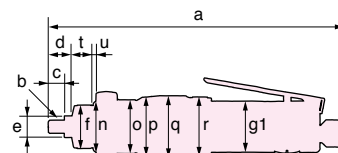

Fig 53

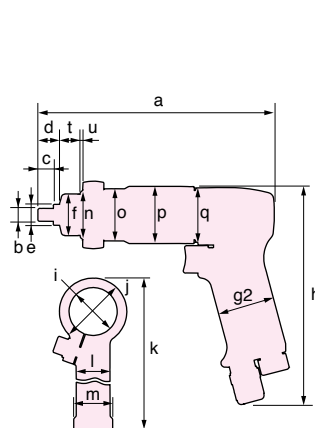
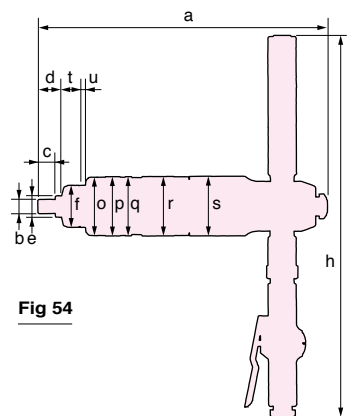

Fig 54



Non-reversible Type

Fig No.	Model	a	b	c	d	e	f	g1	g2	h	i	j	k	l	m	n	o	p	q	r	s	t	u
51	F-6SE	210	3/8-24	12	17	15.88	32	38	-	-	38	52	176	26	30	38	40	42	-	-	-	16	2
52	F-6SF	225	3/8-24	12	17	15.88	32	38	-	-	38	52	176	26	30	38	40	44	46	44	-	16	2
53	F-6PFX	184	3/8-24	12	17	15.88	32	-	44	170	38	52	176	26	30	38	40	44	42	-	-	16	2
54	F-10MT	266	1/2-20	16	22	19.05	38	-	-	352	-	-	-	-	-	53	54	54	54	54	17	5	

Fig 55-1

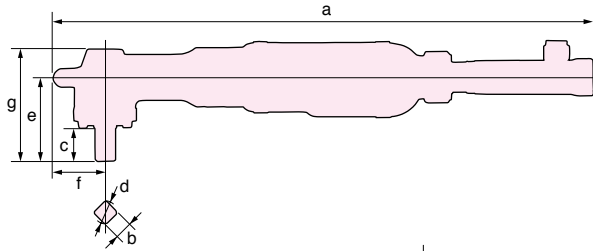
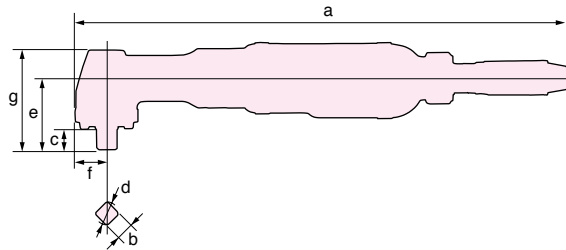

Fig 55-2



Portable Type

Fig No.	Model	a	b	c	d	e	f	g
55-1	FM-2R-2C	630	□19	40	24	100	60	132
55-2	FNR-20	506	□16	17	20	62	31	95
55-2	FNR-20S	506	16	17	20	62	31	95

Fig 56

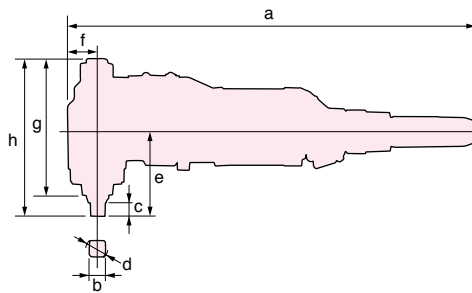
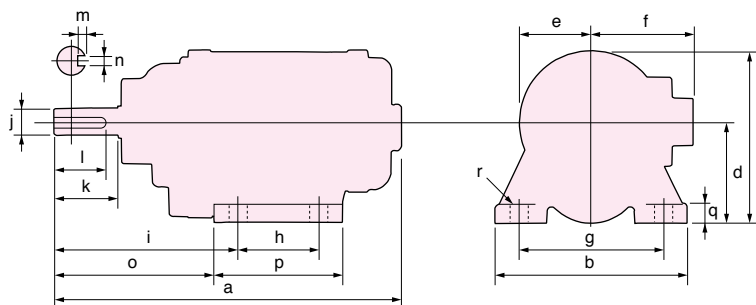

Fig No.	Model	a	b	c	d	e	f	g	h
56	FM-14RK-101	473	□13	16	16.5	80	27	133	158
56	FM-24RK-101	579	□14	17	17.5	98	35	170	197
56	FM-24RK-201	596	□19	20	25.0	122	42	197	227
56	FM-27RK-101	652	□31	30	35.0	151	49	233	275

Fig 57



Stationary Type

Fig No.	Model	a	b	c	d	e	f	g	h	i	j	k	l	m	n	o	p	q	r
57	FM-1R-5	273	150	135	80	55	80	120	70	140	20	50	40	3.0	5	125	100	15	12
57	FM-1R-12	273	150	135	80	55	80	120	70	140	20	50	40	3.0	5	125	100	15	12
57	FM-2R-5	375	180	200	125	75	75	150	70	100	28	60	55	4.0	7	102	100	18	14
57	FM-3R-3	395	180	209	140	75	75	150	70	117	28	60	55	4.0	7	102	100	18	14
57	FM-3R-5	395	180	209	140	75	75	150	70	117	28	60	55	4.0	7	102	100	18	14
57	FM-5R-2	435	210	245	145	100	100	180	90	250	28	60	55	4.0	7	250	120	18	14
57	FM-10R-2	570	240	266	155	95	95	200	130	315	35	80	60	4.5	10	316	170	20	18

Dimensions

Air Motors

Fig 58

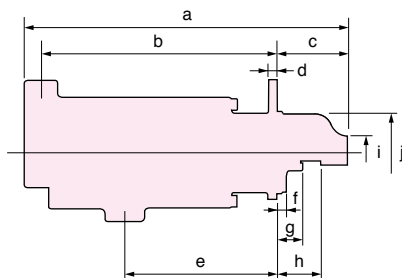

Fig 59

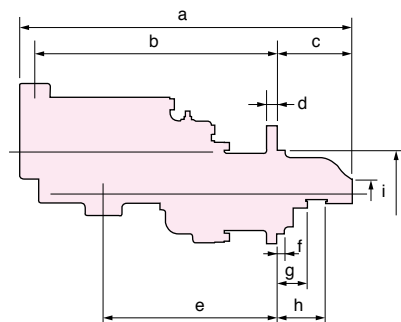

Fig 60

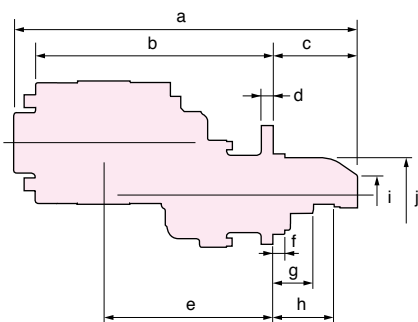
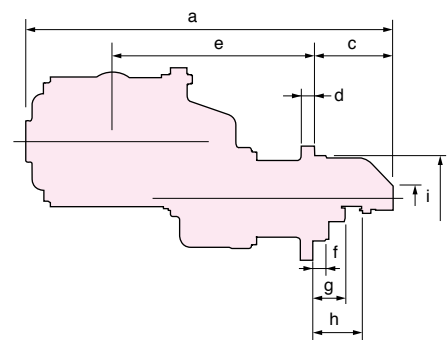

Fig 61



AIR STARTERS

Fig No.	Model	a	b	c	d	e	f	g	h	i	j
58	FSM-50C-101	361	267.5	75.5	10	169.5	5	26.5	46.0	36	89
59	FSM-70C-101	408	287.0	102.0	13	206.0	10	47.0	70.0	40	105
59	FSM-70C-101B	408	287.0	102.0	13	206.0	10	47.0	70.0	40	105
59	FSM-70C-102	408	293.5	95.5	13	212.5	10	40.5	63.5	40	105
59	FSM-70C-103	410	310.0	81.0	12	229.0	10	33.0	51.0	37	105
59	FSM-70C-104	410	270.0	121.5	12	189.0	15	65.0	91.0	42	105
59	FSM-70C-105	410	295.0	95.5	13	213.5	10	40.5	63.5	40	105
59	FSM-70C-106	418	277.0	122.0	12	196.0	10	66.0	92.0	37	110
60	FSM-100C-101	429	298.5	106.0	15	212.0	15	51.0	77.0	46	100
60	FSM-100C-102	428	298.0	105.5	12	212.0	10	50.5	76.5	46	100
60	FSM-100C-103	447	311.0	111.5	13	224.6	10	37.0	62.0	40	100
60	FSM-100C-104	447	311.0	111.5	13	224.6	10	37.0	62.0	40	100
60	FSM-100C-105	428	297.5	106.0	15	211.5	15	51.0	77.0	46	100
60	FSM-100C-201	447	311.0	111.5	13	224.6	10	37.0	62.0	40	100
60	FSM-100C-202	447	311.0	111.5	13	224.6	10	37.0	62.0	40	100
60	FSM-100C-203	447	311.0	111.5	13	224.6	10	37.0	62.0	40	100
61	FSM-200C-101	576	-	125.0	15	314.0	15	50.0	77.0	40	130
61	FSM-200C-102	572	-	115.0	15	319.0	10	50.0	72.0	48	130

Fig 62

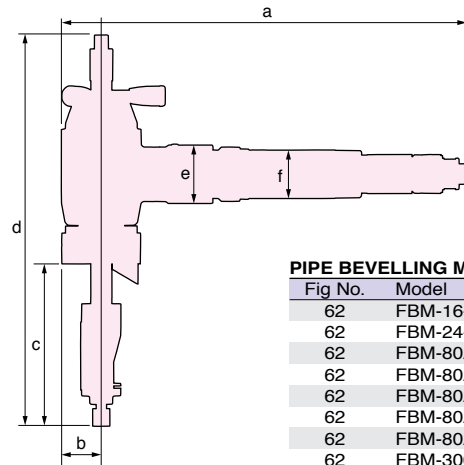

PIPE BEVELLING MACHINES

Fig No.	Model	a	b	c	d	e	f
62	FBM-16-1(S)	261 (272)	19.0	51	268	48	42
62	FBM-24-1(S)	278 (289)	27.5	67	240	48	42
62	FBM-80A-2(S)	403 (403)	39.0	160	388	58	48
62	FBM-80A-3(S)	403 (403)	39.0	160	388	58	48
62	FBM-80A-4(S)	403 (403)	39.0	160	388	58	48
62	FBM-80A-5(S)	403 (403)	39.0	160	388	58	48
62	FBM-80A-6(S)	403 (403)	39.0	160	388	58	48
62	FBM-300-2(S)	524 (557)	56.0	179	511	74	93
62	FBM-300-3(S)	524 (557)	135.0	179	511	74	93
62	FBM-300-4(S)	524 (557)	56.0	179	511	74	93

* () : S type size

Fig 63

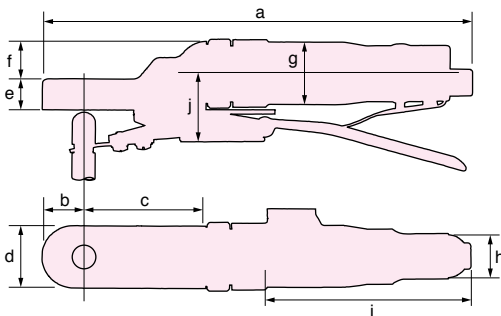

TIP DRESSER

Fig No.	Model	a	b	c	d	e	f	g	h	i	j
63	FTD-18-1	292	30	87	44	21.5	29	47	-	-	-
63	FTD-18A-1	307	30	83	44	22.0	26	46	30	147	54

Fig 64

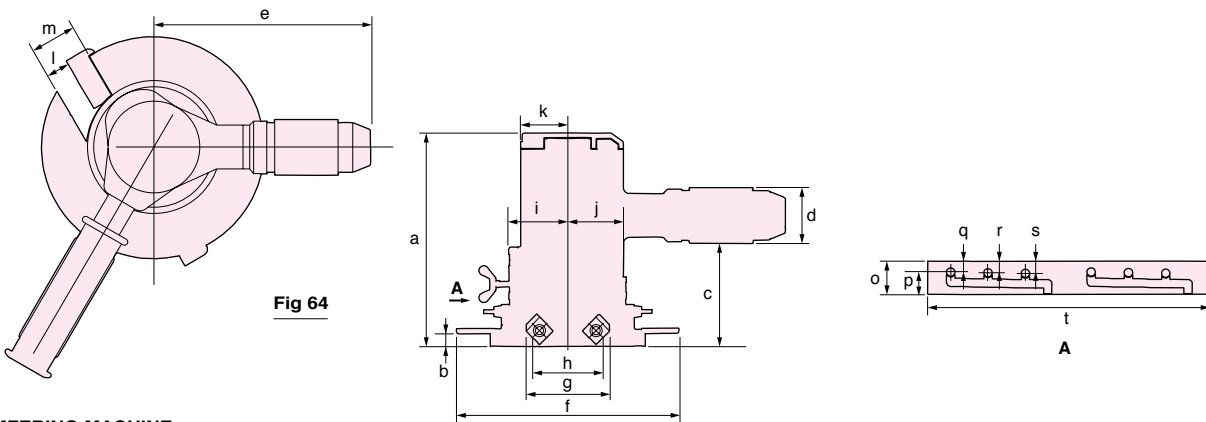

CHAMFERING MACHINE

Portable Models

Fig No.	Model	a	b	c	d	e	f	g	h	i	j	k	l	m	o	p	q	r	s	t
64	FBM-1-1(F)	144	8.5	69 (68)	38 (40)	146	150	56	47.4	40	38	32	15	30	22	14.9	7.1	7.6	8	188.5
64	FBM-1-2(F)	144	8.5	69 (68)	38 (40)	146	150	56	47.4	40	38	32	15	30	22	14.9	7.1	7.6	8	188.5

* () : F type size

Fig 65

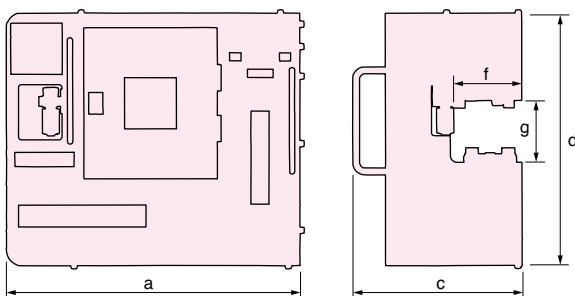
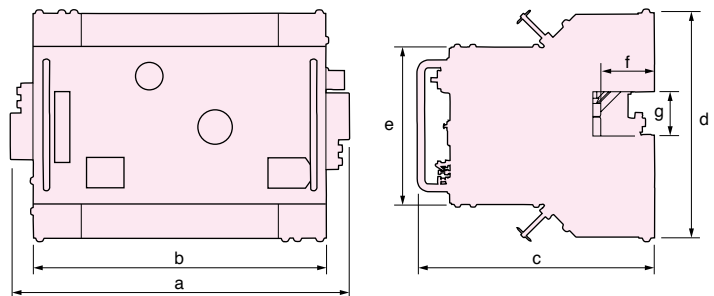

Fig 66



Self-propelled Models

Fig No.	Model	a	b	c	d	e	f	g
65	FX-027-1	388	-	223.0	335	-	90	83.5
66	FX-018-2F	430	380	306.5	291	203	75	57.0

Dimensions

Others

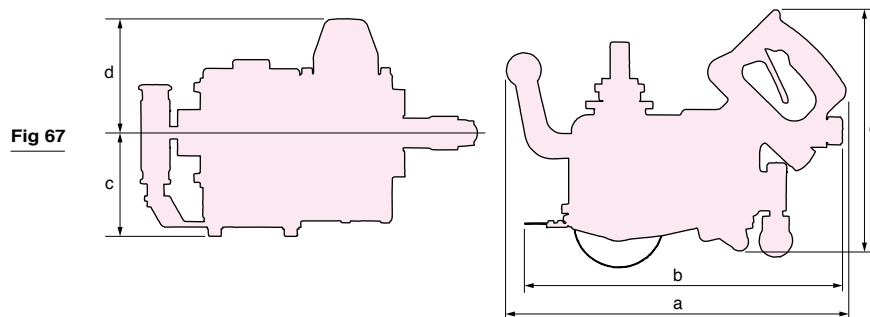

ALUMINUM MILLING MACHINES

Fig No.	Model	a	b	c	d	e
67	FRC-200-1	363	295	79	111	172
67	FRC-300-1	372	357	116	125	268

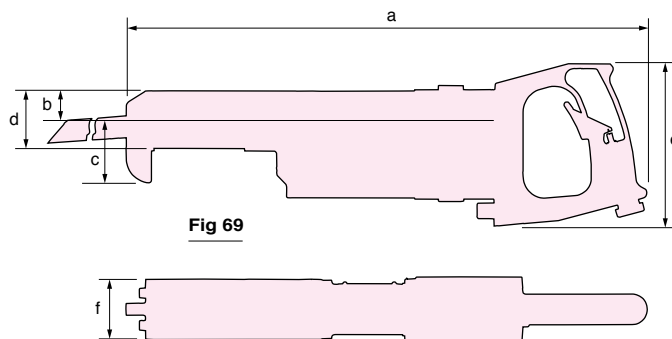
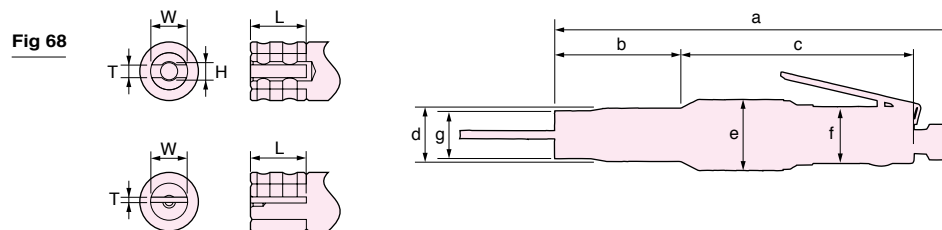

AIR FILES

Fig No.	Model	a	b	c	d	e	f	g	T	W	L	H
68	FRF-4-1(F)	228	73	133.5	30	40	32	27	4	13	21	6

AIR SAWS

Fig No.	Model	a	b	c	d	e	f	g	T	W	L
68	FRF-4-2(F)	232	77	133.5	30	40	32	27	2	13	21
69	FRS-45	421	24	50	46	131	48				

Fig 70

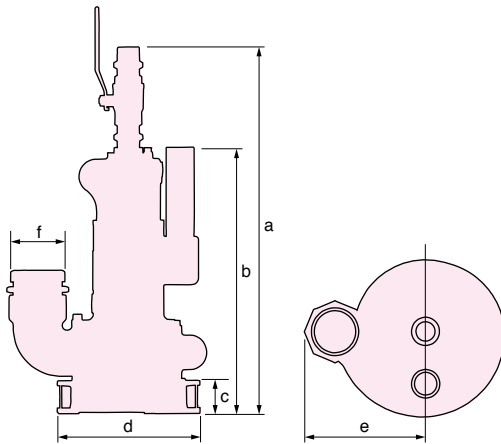
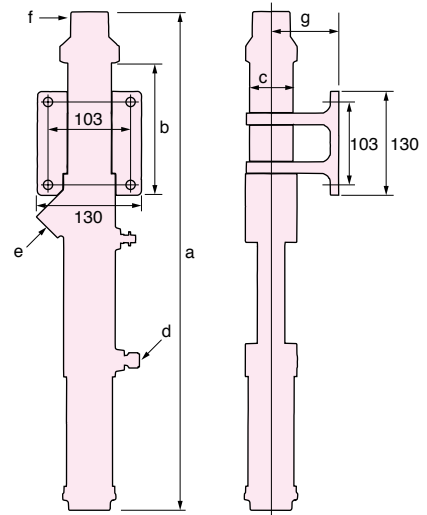

Fig 71



SUMP PUMPS

Fig No.	Model	a	b	c	d	e	f
70	FP-7-2	288.6	231.0	9	110	63	PT 3/4
70	FP-20-1	500.0	374.0	52	200	177	W 82.5-5
70	FP-35-1	607.0	452.6	50	220	187	W 82.5-5

PISTON PUMPS

Fig No.	Model	a	b	c	d	e	f	g
71	FP-11-1	622	137.5	55	PT 1/4	PT 3/4	PT 1 1/2	-
71	FP-11-2	622	137.5	55	PT 1/4	PT 3/4	PT 1 1/2	84

Fig 72

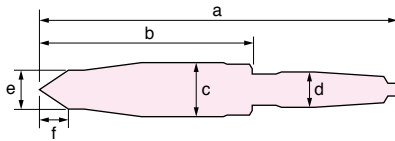

MARKING PEN

Fig No.	Model	a	b	c	d	e	f
72	G-400	147.5	76	19.5	17.5	2.15	1.5

Fig 73

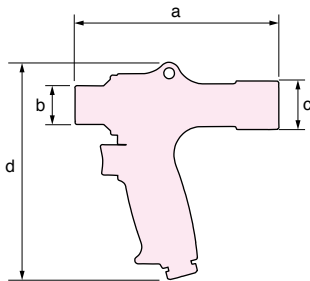
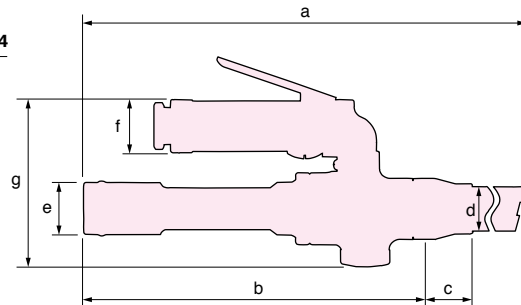

Fig 74



AIR CLEANERS

Fig No.	Model	a	b	c	d
73	AC-200F	145	27	34	153

Fig No.	Model	a	b	c	d	e	f	g
74	FJP-500	1020	248.5	32	32	38	38	121

Dimensions

Others

Fig 75

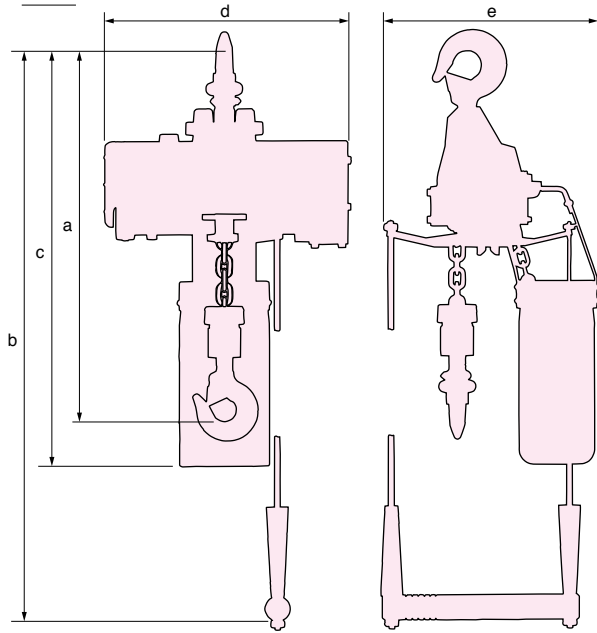
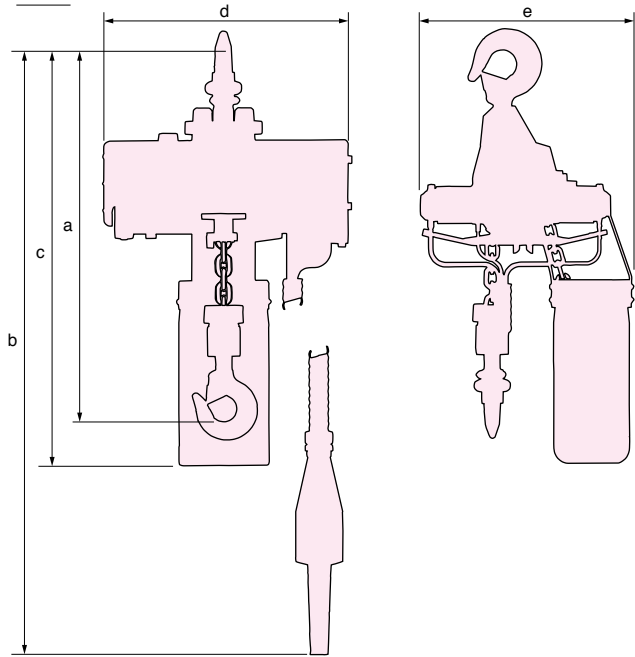

Fig 76



AIR HOISTS

C Type

Fig No.	Model	a	b	c	d	e
75	FAH-25LC	430~3430	2500	560	333	285
75	FAH-50LC	430~3430	2500	560	333	285
75	FAH-100LC	485~3485	2500	560	333	285

P Type

Fig No.	Model	a	b	c	d	e
76	FAH-25LP	430~3430	2500	560	333	289
76	FAH-50LP	430~3430	2500	560	333	289
76	FAH-100LP	485~3485	2500	560	333	289

* C Type: Pull Cord, P Type: Pendant.

Fig 77

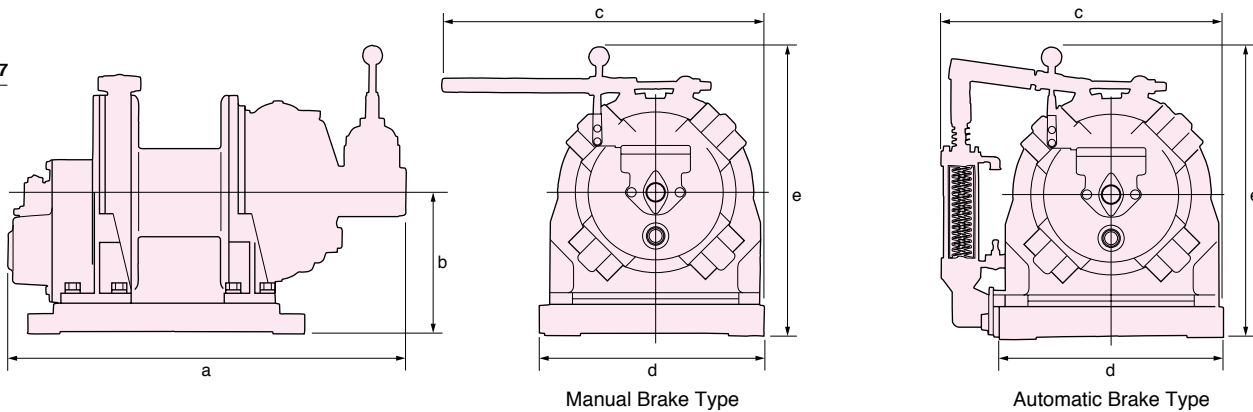

AIR WINCHES

Fig No.	Model	a	b	c	d	e
77	W-05-3-S	536	148	380 (335)	230	346
77	W-05-3-L	650	148	380 (335)	230	346
77	W-10-220-S	830	305	696 (593)	470	617
77	W-10-220-L	1008	305	696 (593)	470	617
77	W-20-220-S	852	305	696 (593)	470	617
77	W-20-220-L	1030	305	696 (593)	470	617
77	W-30-36-S	1041	444	748 (727)	540	764
77	W-30-36-L	1281	444	748 (727)	540	764
77	W-50-36-S	1159	557	- (882)	660	877
77	W-50-36-L	1459	557	- (882)	660	877

* () are Automatic Brake Type.

I N D E X

Assembly Tools Abrasive Tools Drills/Tappers Percussive Tools Air Motors Others

MODEL	PAGE
AC-200F	108
B-40	83
B-50	83
B-60	83
B-80	83
B-90	83
CA-14A	31
CA-7	83
CB-10	83
CB-20	83
CB-30	83
DA-125C-E, M	60
DA-125L-E, M	60
DA-125T-E, M	60
F-10MT	91
F-14CN, 14CN-1S	75
F-14CN-2, 14CN-2S	75
F-22RCN, 22RCN-1S	75
F-22RCR, 22RCR-1S	75
F-32RCN, 32RCN-1S	75
F-32RCNS, 32RCNS-1S	75
F-32RCR, 32RCR-1S	75
F-5SM-2	90
F-5SM-2R	90
F-5SM-8.5	90
F-5SM-8.5R	90
F-6PFX	91
F-6SE	91
F-6SF	91
F-6SM-12	90
F-6SM-12R	90
F-6SM-2.5	90
F-6SM-2.5R	90
F-6SM-21	90
F-6SM-21R	90
F-6SM-28	90
F-6SM-28R	90
F-6SM-5	90
F-6SM-5R	90
F-6SM-8	90
F-6SM-8R	90
F-8SM-12R	90
F-8SM-28R	90
F-8SM-8.5R	90

MODEL	PAGE
F-8SMA-12	90
F-8SMA-28	90
F-8SMA-8.5	90
FA-150K-2	57
FA-150K-3	57
FA-150KG-5	55
FA-150KG-7	57
FA-2C-1	52
FA-2C-1BF	52
FA-2C-2	48
FA-2C-2BF	48
FA-2C-3	48
FA-2C-3BF	48
FA-2CX-1	52
FA-2CX-1BF	52
FA-2CX-2	48
FA-2CX-2BF	48
FA-2CX-3	48
FA-2CX-3BF	48
FA-3C-1	52
FA-3C-1F	52
FA-3C-2	52
FA-3C-2F	52
FA-3CK-1	57
FA-3CK-2	55
FA-3CX-1	52
FA-3CX-1F	52
FA-3CX-2	52
FA-3CX-2F	52
FA-4C-1	53
FA-4C-1F	53
FA-4CH-1	53
FA-4CHK-1	55
FA-4CHK-3	57
FA-4CHK-3F	57
FA-5C-5	56
FA-5E-1F	53
FA-5E-1V	53
FA-5E-1VF	53
FA-5E-13F	53
FA-5E-13VF	53
FA-5E-2F	53
FA-5E-2V	53
FA-5E-2VF	53

MODEL	PAGE
FA-5E-3V	53
FA-5E-6VF	56
FA-5E-7V	56
FA-5E-8V	57
FA-6C-1	54
FA-6C-10	54, 56
FA-6C-12	54
FA-6C-12M	54
FA-6C-20	57
FA-6C-6M	54
FA-6C-8M	54
FA-6C-9M	54, 56
FA-7C-21	57
FA-7E-1V	54
FA-7E-2V	54
FA-7E-3V	54
FA-7E-5VF	54, 56
FA-7E-6VF	54
FA-7E-8VF	54
FA-9C-2	55
FA-9C-2M	55
FA-9C-4	55
FA-9C-4M	55
FAH-100LC	109
FAH-100LP	109
FAH-25LC	109
FAH-25LP	109
FAH-50LC	109
FAH-50LP	109
FBM-1-1	102
FBM-1-1F	102
FBM-1-2	102
FBM-1-2F	102
FBM-16-1, 1S	96
FBM-24-1, 1S	96
FBM-300-2, 2S	96
FBM-300-3, 3S	96
FBM-300-4, 4S	96
FBM-80A-2, 2S	96
FBM-80A-3, 3S	96
FBM-80A-4, 4S	96
FBM-80A-5, 5S	96
FBM-80A-6, 6S	96
FBS-1-1	59

I N D E X

MODEL	PAGE
FBS-1-2	59
FBS-1-3	59
FBS-1-4	59
FC-01-3	83
FC-01-4	83
FC-01SA-H	83
FC-01SA-R	83
FC-1Z-1	83
FC-1Z-2	83
FC-2Z-1	83
FC-2Z-2	83
FC-3Z-1	83
FC-3Z-2	83
FC-4Z-1	83
FC-4Z-2	83
FCD-100R-11, 11S	75
FCD-10X-1, 1F	74
FCD-23R-11, 11S	75
FCD-23R-12, 12S	75
FCD-32R-11, 11S	75
FCD-50R-11, 11S	75
FCD-6A-1	74
FCD-6B-1, 1F	74
FCD-6EX-3	74
FCD-6EX-4	74
FCD-6X-1, 1F	74
FCD-6X-2, 2F	74
FCD-75R-11, 11S	75
FCH-20, 20-1F	82
FCH-20F, 20F-1F	82
FCH-25, 25-1F	82
FCH-25B, 25B-1F	82
FD-4	35
FD-4P	35
FD-5	35
FD-5P	35
FDM-202	19
FDT-2-1	18
FET-111-2	20
FET-1111-2	20
FET-133-2	20
FET-1333-2	20
FET-33-1	20
FET-33D-1	20
FET-33D-10	20
FET-44-3	20
FET-44D-3	20
FET-44D-30	20
FET-55-3	20
FET-55D-3	20
FET-55D-30	20
FET-66-3	20
FET-66D-3	20
FET-66D-30	20
FET-77-1	20
FET-777-1	20

MODEL	PAGE
FET-88-4	20
FET-888-4	20
FET-99-2	20
FET-999-2	20
FFA-2-2	16
FFA-3-1	16
FFC-3-1	15
FG-06-1	44
FG-12U-1	47
FG-12U-1F	47
FG-12U-2	47
FG-12UX-1	47
FG-12UX-1F	47
FG-12UX-2	47
FG-13-1	45
FG-13-10	45
FG-13-1F	45
FG-13-10F	45
FG-13-2	45
FG-13-20	45
FG-13X-1	45
FG-13X-10	45
FG-13X-1F	45
FG-13X-10F	45
FG-13X-2	45
FG-13X-20	45
FG-25D-1	47
FG-25D-1F	47
FG-25D-2	47
FG-25DX-1	47
FG-25DX-1F	47
FG-25DX-2	47
FG-26-10	46
FG-26-10F	46
FG-26-20	46
FG-26-20BF	46
FG-26L-1	48
FG-26L-1BF	48
FG-26X-10	46
FG-26X-10F	46
FG-26X-20	46
FG-2VX-1F	49
FG-3H-1	50
FG-3H-1F	50
FG-3H-2	50
FG-3H-2F	50
FG-3H-5	48
FG-3H-5F	48
FG-3H-6	49
FG-3HL-1	51
FG-3HL-1F	51
FG-3VX-1F	49
FG-3VX-2F	49
FG-3VX-3F	49
FG-3VX-6F	49
FG-4H-1	50

MODEL	PAGE
FG-4H-1F	50
FG-4H-2	50
FG-4H-2F	50
FG-4HL-1	51
FG-4HL-1F	51
FG-4VA-1	49
FG-4VA-2	49
FG-50-1	46
FG-50-1F	46
FG-50-2	46
FG-50-2BF	46
FG-50D-1	47
FG-50D-1F	47
FG-50D-2	47
FG-50DX-1	47
FG-50DX-1F	47
FG-50DX-2	47
FG-50L-1	51
FG-50L-1BF	51
FG-50X-1	46
FG-50X-1F	46
FG-50X-2	46
FG-50Y-1	51
FG-50Y-1BF	51
FG-5H-1	50
FG-5H-1M	50
FG-5H-2	50
FG-5H-2M	50
FG-5HL-2	51
FG-5HL-2M	51
FG-5PX-1	57
FG-6H-1	50
FG-6H-1M	50
FG-8H-1	50
FG-8H-1C	50
FG-8H-1M	50
FG-8H-2	50
FG-8H-2M	50
FJP-500	108
FJT-10-1	18
FJT-10A-1	18
FJT-10B-1	18
FJT-10C-1	18
FJT-16-1	18
FJT-16A-1	18
FJT-16B-1	18
FJT-16C-1	18
FJT-5-1	18
FJT-5A-1	18
FJT-5B-1	18
FJT-5C-1	18
FLE TYPE	100
FLM-1	16
FM-10R-2	91
FM-14RK-101	91
FM-1R-12	91

MODEL	PAGE
FM-1R-5	91
FM-24RK-101	91
FM-24RK-201	91
FM-27RK-101	91
FM-2R-2C	91
FM-2R-5	91
FM-3R-3	91
FM-3R-5	91
FM-5R-2	91
FMC-1-1	15
FNR-20	91
FNR-20S	91
FNS-2, 2-1F	84
FNS-2P, 2P-1F	84
FOR-125B-E, M	60
FOR-125BF-E, M	60
FOR-125T-E, M	60
FOR-150B-E, M	60
FOR-150BF-E, M	60
FOR-150T-E, M	60
FOS-175B-E, M	60
FOS-175BF-E, M	60
FOS-175T-E, M	60
FOS-230B-E	60
FOS-230BF-E	60
FOS-230T-E	60
FOS-400B-E	60
FOS-400BF-E	60
FOS-400T-E	60
FOW-10-1	36
FOW-10-2	36
FP-11-1	106
FP-11-2	106
FP-20-1	106
FP-35-1	106
FP-7-2	106
FPT-110-1	23
FPT-110D-1	24
FPT-110D-10	24
FPT-110S-1	23
FPT-110SD-1	24
FPT-110SD-10	24
FPT-1110-1	23
FPT-1110-1L	23
FPT-1330-1	23
FPT-1330-1L	23
FPT-1660-1	23
FPT-330-1	23
FPT-330D-1	24
FPT-330D-10	24
FPT-330S-1	23
FPT-330SD-1	24
FPT-330SD-10	24
FPT-440-1	23
FPT-440-1L	23
FPT-440D-1	24

MODEL	PAGE
FPT-440D-10	24
FPT-440D-1L	24
FPT-440D-10L	24
FPT-440S-1	23
FPT-440SC-1	24
FPT-440SD-1	24
FPT-440SD-10	24
FPT-550-1	23
FPT-550-1L	23
FPT-550D-1	24
FPT-550D-10	24
FPT-550D-1L	24
FPT-550D-10L	24
FPT-550S-1	23
FPT-550SC-1	24
FPT-550SD-1	24
FPT-550SD-10	24
FPT-660-1	23
FPT-660-1L	23
FPT-660D-1	24
FPT-660D-10	24
FPT-660D-1L	24
FPT-660D-10L	24
FPT-660S-1	23
FPT-660SC-1	24
FPT-660SD-1	24
FPT-660SD-10	24
FPT-770-1	23
FPT-770-1L	23
FPT-770G-1	25
FPT-770G-1L	25
FPT-770S-1	23
FPT-770SC-1	24
FPT-770SCG-1	25
FPT-880-3	23
FPT-880-3L	23
FPT-990-1	23
FPT-990-1L	23
FPW-110-1	26
FPW-110D-1	26
FPW-110D-10	26
FPW-110S-1	27
FPW-110SD-1	27
FPW-110SD-10	27
FPW-1110-1	26
FPW-1330-1	26
FPW-1660-1	26
FPW-2220S-1	27
FPW-330-1	26
FPW-330D-1	26
FPW-330D-10	26
FPW-330S-1	27
FPW-330SD-1	27
FPW-330SD-10	27
FPW-440-3	26
FPW-440D-3	26

MODEL	PAGE
FPW-440D-30	26
FPW-440S-1	27
FPW-440SC-1	28
FPW-440SD-1	27
FPW-440SD-10	27
FPW-550-3	26
FPW-550D-3	26
FPW-550D-30	26
FPW-550S-1	27
FPW-550SC-1	28
FPW-550SD-1	27
FPW-550SD-10	27
FPW-660-4	26
FPW-660D-4	26
FPW-660D-40	26
FPW-660S-1	27
FPW-660SC-1	28
FPW-660SD-1	27
FPW-660SD-10	27
FPW-770-3	26
FPW-770D-3	26
FPW-770D-30	26
FPW-770G-1	28
FPW-770S-1	27
FPW-770SC-1	28
FPW-770SCG-1	28
FPW-880-6	26
FPW-990-3	26
FR-18B, 18B-2F	85
FR-18L, 18L-2F	85
FR-22B, 22B-2F	85
FR-22L, 22L-2F	85
FR-25B, 25B-2F	85
FR-25L, 25L-2F	85
FR-32, 32-2F	85
FRC-200-1	104
FRC-300-1	104
FRD-100R-1, 1S	73
FRD-12Z-1, 1C	73
FRD-16Z-1, 1C	73
FRD-20R-21, 21S	73
FRD-20R-22, 22S	73
FRD-23R-21, 21S	73
FRD-23R-22, 22S	73
FRD-25R-11, 11S	73
FRD-28R-11, 11S	73
FRD-32R-11, 11S	73
FRD-32R-12, 12S	73
FRD-40R-11, 11S	73
FRD-50R-11, 11S	73
FRD-5P-1	72
FRD-5S-1, 1F	72
FRD-5S-2T, 2TF	72
FRD-65R-1, 1S	73
FRD-6PX-2	72
FRD-6PX-3	72

I N D E X

MODEL	PAGE
FRD-6PX-5	72
FRD-6PX-7	72
FRD-6S-2, 2F	72
FRD-6S-3, 3F	72
FRD-6S-5, 5F	72
FRD-6S-7, 7F	72
FRD-75R-1, 1S	73
FRD-8PX-1	72
FRD-8PX-2	72
FRD-8PX-3	72
FRF-4-1, 1F	105
FRF-4-2, 2F	105
FRH-3-1	82
FRH-3-2	82
FRH-6-1	82
FRH-6-2	82
FRH-6A-1	82
FRH-6A-2	82
FRS-45	105
FRW-10N-2	36
FRW-13N-3	36
FRW-13N-4	36
FRW-6NX-3	36
FRW-6NX-3A	36
FRW-6NX-4	36
FRW-6NX-4A	36
FRW-8NX-2	36
FRW-8NX-2A	36
FS-2A, 2A-1F	84
FSE TYPE	100
FSM-100C-101	93, 94
FSM-100C-102	93, 94
FSM-100C-103	93, 94
FSM-100C-104	93, 94
FSM-100C-105	93, 94
FSM-100C-201	93, 94
FSM-100C-202	93, 94
FSM-100C-203	93, 94
FSM-200C-101	94
FSM-200C-102	94
FSM-50C-101	92, 94
FSM-70C-101	93, 94
FSM-70C-101B	93, 94
FSM-70C-102	93, 94
FSM-70C-103	93, 94
FSM-70C-104	93, 94
FSM-70C-105	93, 94
FSM-70C-106	93, 94
FT-13Z-1	78
FT-6BX-1 D	78
FT-6BX-1 T	78
FT-6P-1	78
FT-8PX-1	78
FTD-18-1	101
FTD-18A-1	101
FTL TYPE	100

MODEL	PAGE
FTS TYPE	100
FUWS-1000-1M	99
FUWS-1000-1T	99
FUWS-1000-2T	99
FUWS-1000-3T	99
FUWS-2-1	100
FV-7-1M	58
FV-7-2M	58
FV-7-4M	58
FV-9BH-1M	58
FV-9BH-4M	58
FVT-1	19
FW-100-1	33
FW-10PH-1	30
FW-10PH-2	30
FW-10PX-5	30
FW-10SX-5	31
FW-14PH-1	30
FW-14PH-2	30
FW-14PH-3	30
FW-14PX-5	30
FW-14SX-5	31
FW-19PX-5	33
FW-19Z-5	32
FW-19Z-5C	32
FW-250-1	32
FW-250-1C	32
FW-250-2	32
FW-250-2C	32
FW-250P-1	33
FW-250P-2	33
FW-320-1	32
FW-320-1C	32
FW-320-1CL	32
FW-320-1L	32
FW-320P-1	33
FW-420-1	32
FW-420-1C	32
FW-420-1CL	32
FW-420-1L	32
FW-420-2	32
FW-420-2C	32
FW-44PA-2	29
FW-44PAD-2	35
FW-44PAD-20	35
FW-44SA-1	29
FW-44SAD-1	35
FW-44SAD-10	35
FW-50-7	33
FW-5PX-6	30
FW-5PXD-6	34
FW-5PXD-60	34
FW-5SXD-7	34
FW-5SXD-70	34
FW-5SXD-8	34
FW-5SXD-80	34

MODEL	PAGE
FW-66PA-2	29
FW-66PAD-2	35
FW-66PAD-20	35
FW-66SA-1	29
FW-66SAD-1	35
FW-66SAD-10	35
FW-6PH-1	30
FW-6PH-11	30
FW-6PHD-1	34
FW-6PL-1	30
FW-6PLD-1	34
FW-6PM-1	30
FW-6PMD-1	34
FW-6PMD-10	34
FW-6PX-5	30
FW-6PX-6	30
FW-6PXD-6	34
FW-6PXD-60	34
FW-6SCX-6	31
FW-6SX-5	31
FW-6SX-6	31
FW-6SXD-6	34
FW-6SXD-60	34
FW-75-7	33
FW-88P-1	29
FW-8PH-3	30
FW-8SCH-2	31
FW-8SH-2	31
FX-018-2F	102
FX-027-1	102
FYK-110A	108
FYK-220A	108
G-400	107
MB-B	19
OB-75L-E, M	60
OB-75T-E, M	60
OB-90L-E, M	60
TT-1000	18
TT-150	18
TT-20	18
TT-300	18
TT-50	18
TT-500	18
TURBO-100	44
TURBO-100A	44
W-05-3-L	110
W-05-3-S	110
W-10-220-L	110
W-10-220-S	110
W-20-220-L	110
W-20-220-S	110
W-30-36-L	110
W-30-36-S	110
W-50-36-L	110
W-50-36-S	110