



Koken[®]



75th Anniversary



2022-23
Koken TOOL CO., LTD.





INDEX

Z-SERIES
Z-SERIE
SERIES-Z

P021 - 036



Z-SERIES

HAND SOCKETS
HAND STECKSCHLÜSSEL
DOUILLES À MAIN

P037 - 130



HAND

TITAN-SOCKETS & ACCESSORIES
TITAN STECKSCHLÜSSEL UND ZUBEHÖRTEILE
DOUILLES ET ACCESSOIRES TITAN

P131 - 132



TITANIUM

ACCESSORIES
ZUBEHÖRTEILE
ACCESSOIRES

P133 - 168



ACCESSORIES

SCREWDRIVERS
SCHRAUBENDREHER
TOURNEVIS

P169 - 174



SCREWDRIVERS

IMPACT SOCKETS
IMPACT STECKSCHLÜSSEL
DOUILLES IMPACT

P175 - 248



IMPACT

SLEEVE-DRIVE SOCKETS
SLEEVE-DRIVE STECKSCHLÜSSEL
DOUILLES, SLEEVE DRIVE

P249 - 255



SLEEVE-DRIVE

SOCKETS WITH TURNABLE PLASTIC PROTECTORS
STECKSCHLÜSSEL MIT DREHBAREN SCHUTZHÜLSEN AUS KUNSTSTOFF
DOUILLES A PROTECTIONS PLASTIFIEES

P259 - 264



PROTECTOR

INDUSTRIAL SOCKETS
STECKSCHLÜSSEL, INDUSTRIE-AUSFÜHRUNG
CLÉS À DOUILLES, FINISSAGE INDUSTRIEL

P265 - 270



INDUSTRIAL

AUTOMOTIVE TOOLS
WERKZEUGE FÜR KFZ UND NUTZFAHRZEUGE
OUTILS POUR POIDS LOURDS ET VÉHICULES UTILITAIRES

P271 - 292



AUTOMOTIVE

MOTORCYCLE TOOLS
MOTORRAD WERKZEUGE
OUTILLAGE MOTO

P293 - 296



MOTORCYCLE

TOOLS FOR CONSTRUCTION SITES
WERKZEUGE FÜR DAS BAUGEWERBE
OUTILLAGE POUR L'INDUSTRIE DU BÂTIMENT

P297- 303



CONSTRUCTION

SPARE PART SETS
ERSATZTEILSÄTZE
PIÈCES DE RECHANGE

P305- 309



SPARE PART

Pictograms Socket openings / Bit shape					
	FLAT DRIVE® (6-point)		TORX® (E)		TORX® (T)
	FLAT DRIVE® (12-point)		NUT GRIP® / TORX® (E)		Tamper-Resistant TORX® (TH)
	NUT GRIP®		TORXplus® (EP)		TORXplus® (IP)
	Surface Drive		LH-STIX® (LH-S)		Tamper-Resistant TORXplus® (IPR)
	PATHFINDER®		Bit Holder		Triple-Square(XZN)
	Flare Nut		Phillips		Triple-Square with Hole(XZN)
	Square		Slotted		Ribe-CV
	Double Square		Hexagon		POLYDRIVE
	Stud Bolt Puller		PZ		Double-Hexagon
	NUTTWISTER®		Square Male		Socket Set on Rail

Pictograms Mechanics / Specification					
	SODH®-System		Thin-Walled(6-point)		1/4"(6.35mm) Sq. Dr.
	SODH®-System (4750 series)		Thin-Walled(12-point)		3/8"(9.5mm) Sq. Dr.
	Two-Step Dog		with Magnet		1/2"(12.7mm) Sq. Dr.
	Three-Step Dog		20 tooth Gear		5/8"(15.9mm) Sq. Dr.
	Quick Release Button		24 tooth Gear		3/4"(19.0mm) Sq. Dr.
	Flexible Head		30 tooth Gear		1"(25.4mm) Sq. Dr.
	Swivel Head		36 tooth Gear		1.1/2"(38.1mm) Sq. Dr.
	L/R Marking		44 tooth Gear		2.1/2"(63.5mm) Sq. Dr.
	Oval Shape Shank		45 tooth Gear		3.1/2"(88.9mm) Sq. Dr.
	Wobble-Fix		60 tooth Gear		Caution
			72 tooth Gear		Modification



Reproduction in whole or in part without proper and prior authorization is prohibited.
 Der Nachdruck, im ganzen oder auch auszugsweise, bedarf unserer ausdrücklichen, vorherigen Genehmigung.
 La reproduction de ce catalogue en tout ou en partie sans autorisation préalable est interdite.
 Specifications or designs of any product in this catalogue are subject to change without notice.
 Wir behalten uns das Recht vor, jedes in diesem Katalog gezeigte Werkzeug, auch ohne vorherige Ankündigung, in Ausführung und Design ändern zu dürfen.
 Nous nous réservons le droit de modifier les modèles et les dimensions des outils présentés dans ce catalogue et ce sans autre notification préalable.



■ TEST AND LABORATORY
 ■ TESTLABOR
 ■ TEST AU LABORATOIRE



Ko-ken uses a variety of test equipment. Strength is measured by the Static Load Test Machine that can measure torque load up to 5,000Nm. Durability is measured by the Cyclic Test Machine and corrosion resistance testing is done by the Salt Spray Test Machine. The test results are used to improve our standard products and assist with new product design and development.

Wir verfügen über die verschiedensten Testgeräte:
 -Die Festigkeitseigenschaften der Werkzeuge werden mit einer statischen Drehmoment-Testmaschine, die Prüfdrehmomente bis 5.000Nm erzeugen kann, überprüft.
 -Die Dauerbelastbarkeit wird mit einer Testmaschine durchgeführt mit der die Werkzeuge zyklisch in langen Testreihen belastet werden.
 - Der Korrosionsschutz wird regelmäßig mittels Salzsprühnebelprüfung kontrolliert.
 Die gewonnenen Testergebnisse ermöglichen eine stetige Verbesserung der Standardwerkzeuge und helfen bei der Entwicklung neuer Produkte.

Ko-ken utilise plusieurs types de tests. La résistance est mesurée par une installation de test à charge statique d'une capacité de 5.000 Nm. La durée de vie est déterminée par une machine à cycles et la résistance à la corrosion par une installation à projection de sel.
 Les résultats de ces tests sont destinés à améliorer nos produits standards et à assister au développement de nouveaux produits.



■ DESIGN AND DEVELOPMENT
 ■ ENTWICKLUNG UND DESIGN
 ■ DESIGN ET DEVELOPPEMENT



The 3D-CAD is used to improve standard products, designing new products and making customized items for special requirements. Trial products are regularly developed, manufactured and tested to improve the durability, appearance and functionality of all tools produced by Ko-ken.

3D-CAD Programme helfen uns sowohl, bei der Weiterentwicklung unserer Standardwerkzeuge, als auch beim Designen neuer Produkte und beim Entwerfen von Sonderanfertigungen. Um die Zuverlässigkeit und Funktionalität unserer Werkzeuge zu verbessern, werden ständig Versuchswerkzeuge gefertigt.

La technique CAD-3D est utilisée pour l'amélioration des produits standards, le design des nouveaux produits et la réalisation d'outils spéciaux. Des séries d'essai sont régulièrement développées, fabriquées et testées pour améliorer l'apparence et la fonctionnalité de tous les produits Ko-ken.



■ FORGING
 ■ SCHMIEDEN
 ■ FORGEAGE



The Forming machines are used for the forging process. These machines can produce mass quantities of sockets and parts with high accuracy that ordinary drop forging machines can not achieve. On the other hand, ordinary forging machines are also used for small production runs.

Zum Schmieden verwenden wir eigene Umformmaschinen.

Diese Maschinen werden zur Produktion großer Stückzahlen von Steckschlüsseln und Betätigungswerkzeugen verwendet mit einer Genauigkeit, die mit normalen Gesenkschmiede Maschinen nicht gewährleistet werden kann.

Bei kleineren Fertigungsserien werden zur Fertigung auch kleinere Gesenkschmiedemaschinen verwendet.

Des machines de formage à froid sont utilisées. Ces machines peuvent produire en masse les douilles et accessoires avec une précision supérieure à la forge conventionnelle. Toutefois, pour des petites séries, des machines à forger traditionnelles sont également utilisées.



■ TURNING
 ■ DREHEN
 ■ TOURNASAGE



The forged steel is turned into required shapes and dimensions. The MC (Machining Center) operates with extraordinary speed and precision. The article number, size, logo, production number, and MADE IN JAPAN are marked on the products after the turning process has been completed.

Der geschmiedete Stahl wird nun auf die endgültige Form abgedreht.

Unser Maschinenzentrum arbeitet hier mit außergewöhnlicher Geschwindigkeit und Präzision.

Nach dem Drehvorgang wird das Werkzeug mit Artikelnummer, Abmessung, Logo, Produktionsnummer und MADE IN JAPAN markiert.

Après la forge, les pièces sont usinées à la bonne dimension par tournage. Les centres d'usinage travaillent avec une précision et une vitesse extraordinaire.

Le numéro d'article, la dimension, le logo Ko-ken, un numéro de production ainsi que la mention « Made in Japan » sont gravés sur le produit après tournage.



■ HEAT TREATMENT
■ HÄRTEN
■ DURETE



To make the tools stronger and more durable, proper heat treatment is critically important. The temperature and the time of the heat treatment are strictly regulated by a very accurate control device.

Um die optimale Stabilität und Festigkeit der Werkzeuge zu erreichen ist der Härtingsprozess der Werkzeuge von höchster Wichtigkeit.

Die hohe Genauigkeit von Temperatur- und Dauer der Wärmebehandlung werden durch sehr genaue Regeleinrichtungen in den Härteöfen erreicht.

Pour la résistance et la dureté de l'outil, un traitement thermique adapté est indispensable. Les températures et la dureté de traitement sont très précisément contrôlées.



■ INSPECTION
■ MESSEN UND PRÜFEN
■ CONTRÔLE



Our products are periodically checked at each production process by inspection devices. Highly accurate 3-D measuring instruments are used to inspect and confirm dimensions.

Unsere Produkte werden periodisch nach jedem Produktionsprozess überprüft.

Hierzu verwenden wir sehr genaue 3D Messgeräte.

Nos produits sont contrôlés périodiquement à chaque étape de leur fabrication.

Des instruments de mesure en 3D, très précis sont employés pour la vérification des dimensions.





FLAT DRIVE®

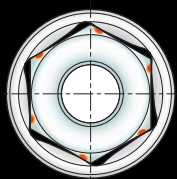

Flat Drive is designed to guarantee a flat surface contact between the socket and the bolt/nut.

The Flat contact reduces wear and allows to transmit a higher torque value.

The Flat Drive System is also used for the square drive end as well as the hexagonal or bi-hexagonal openings of the socket.

Das Flat Drive Design sorgt für die optimale Kraftübertragung zwischen den Flächen des Steckschlüssels und der Schraube. Dies erlaubt eine Übertragung von höheren Drehmomenten. Das Flat Drive System findet ebenfalls bei allen Antriebsvierkanten sowie bei 6-kant und 12-kant Profilen Verwendung.

Le profil Flat Drive garantit un contact optimal entre la douille et l'écrou. Ce contact « à plat » réduit l'usure et permet la transmission d'un couple plus élevé. Ce système Flat Drive est utilisé pour tous les carrés conducteurs ainsi que pour toutes nos douilles 6-pans et 12-pans.

SOCKETS STECKSCHLÜSSEL DOUILLES



NUT GRIP®



Twin balls at the 6-point opening hold bolt/nut tightly for safe and reliable work.

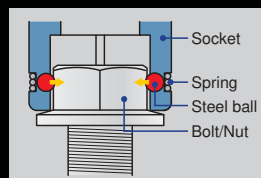

Die zwei Kugeln in der 6-kant Öffnung unserer NUT GRIP Steckschlüssel halten die Schraube sicher im Steckschlüssel. Dies erlaubt ein Arbeiten auch an schwer zugänglichen Stellen.

Les 2 billes dans l'ouverture du 6-pans de la douille retiennent l'écrou de manière sûre et efficace.

SURFACE DRIVE



Surface drive sockets are designed to retain contact with the flat sides of the nut in order to reduce nut wear.

These sockets are ideal for using on polished nuts, aluminum nuts and nuts with worn out points.

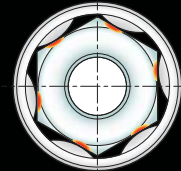

Das Profil unserer Surface-Drive Steckschlüssel greift die Schraube an deren Flächen.

Dies sichert eine höhere Kraftübertragung und verhindert ein Durchrutschen des Steckschlüssels. Diese Steckschlüssel eignen sich besonders für polierte Schrauben, Aluminium Schrauben und Schrauben bei denen die Ecken bereits abgerundet sind.

Notre profil Surface Drive assure le contact entre la douille et les plats de l'écrou. Ceci réduit l'usure et permet la transmission d'un couple plus élevé. C'est une solution idéale pour les écrous polies, celles en aluminium ou arrondies.

PATHFINDER®



The beveled flats of the 6-point opening of the PATHFINDER socket engage the nut almost immediately. PATHFINDER sockets are ideal for using with power tools in automatic assembly processes, as the power tool does not have to be totally stopped for the socket to engage the nut.

Da die Maschine nicht nach jedem Schraubvorgang angehalten werden muss, ergibt sich eine erhöhte Produktivität, die sich bei vollautomatischen Maschinen (Mehrspindelschrauber) ganz besonders auswirkt.

Les parois en biais du 6-pans des douilles PATHFINDER assurent l'engagement quasi immédiat de l'écrou. Le fait de ne pas devoir arrêter la machine après chaque serrage procure un gain de productivité particularité appréciable dans les chaînes de montage automatiques.



RATCHET HANDLE KNARRENGRIFFE MANCHE À CLIQUET



J-Type
Rubber Grip
Gummigriff
Manche en matière plastique



P-Type
Plain Grip
Glatter Griff
Manche lisse



N-Type
Knurled Grip
Gerändelter Griff
Manche moletée



SODH®-System

Two dogs are located in the ratchet body so that the dogs and springs are held securely in place, allowing the reversing lever and dog to switch smoothly.

The torque load on the gear is transmitted vertically to the dog, and in turn, down the ratchet handle. This mechanism locks gears tightly in place while torque is being applied, thus avoiding any gear slippage.

Die zwei Sperrklinken sind fest im Knarrenkörper verankert, die Federn sind dadurch fest fixiert.

Die Umschaltung der Knarre erfolgt leicht und sicher.

Die Kraft des Knarrenzahnrad wird vertikal auf die Sperrklinken übertragen, dadurch wird das Überspringen des Knarrenmechanismus sicher vermieden.

Les 2 rochets sont insérés dans le corps du cliquet. De ce fait les ressorts sont également fermement fixés. L'inversion se produit sans à-coups. Ce mécanisme assure aussi une transmission du couple sans risque de ripage.



Two-Step Dog

Two flats hold two teeth of the ratchet gear, thus increasing the maximum torque load of the ratchet compared with a single-step system.

Die Kraft wird über zwei Zähne des Knarrenzahnrades übertragen. Dies erlaubt eine höhere Kraftübertragung gegenüber Knarren mit einem Zahn Mechanismus.

La force est transmise par les deux dents du mécanisme. Ceci permet un couple plus élevé par rapport aux systèmes à une seule dent .



Three-Step Dog

Two dogs are set in the same axis, and the three teeth hold the ratchet gear. The enlarged contact area produces an about 10% higher torque value and the SODH®-System provides smooth and light movements.

Die scharnierartig eingelagerten Sperrklinken haben jetzt jeweils drei Zähne im Eingriff. Die dadurch vergrößerte Greiffläche erhöht das maximale Drehmoment um ca. 10%. Auch diese Knarre besticht durch ihren leichten und geschmeidigen Lauf.

Les deux rochets étant placés sur le même axe, les trois dents de l'engrenage sont engagées en permanence. Ce système assure une augmentation de 10% du couple maximum admissible. Ce cliquet se caractérise également par son fonctionnement souple et sans à-coup.



SHAPE OF HANDLE
FORMGEBUNG DER GRIFFE
MODELE DE POIGNEE



OVAL SHAPE SHANK



Unique designed oval shape shank provides extra strength and durability.

Der einzigartige ovale Schaftquerschnitt in Belastungsrichtung erhöht die Stabilität und Widerstandsfähigkeit.

La section ovale, orientée dans le sens de l'effort, confère à cet outil une résistance et une durée de vie incomparable.

KNURLING



Rotation and general handling of extensions with oily hands is greatly improved with the **Koken** developed 6 point knurling. Also the **Koken** 6 point knurling stops the extensions from rolling around the work area.

Durch die von **Koken** entwickelte 6 fache Rändelung wird die Handhabung deutlich erleichtert.

Außerdem wird das Herumrollen der Verlängerungen wirksam verhindert.

La manipulation des rallonges est grandement facilitée par le profil moleté développé par **Koken**. Ce même profile empêche le roulement intempestif des rallonges sur le plan de travail.



WOBBLE-FIX



TWO WAY USAGE

- a) In a fixed position, as a normal extension bar
- b) In a half-fixed position, as a flexible extension bar providing a 15° angle operation.

Winkelverlängerungen lassen sich in zwei Einstellungen verwenden

- a) voll eingesteckt und starr
- b) halb eingesteckt, mit einem Arbeitswinkel von 15°.

Deux utilisations possibles

- a) comme rallonge normale, dans une position fixe
- b) comme une rallonge angulaire avec une possibilité d'inclinaison jusqu'à 15°

Fix

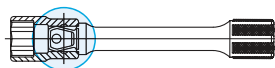

Wobble

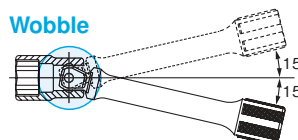



STUD BOLT PULLER / SETTER STEHBOLZENAUSDREHER UND STEHBOLZENSETZER EXTRACTEURS DE GOUJONS



STUD BOLT PULLER STEHBOLZENAUSDREHER DEGOUJONNEUSES



Hexagon body design can lessen the excessive load on cages and rollers inside the pullers.

Der neue Körper mit sechs Walzenmulden verteilt den Druck auf den Käfig und die Walzen weitaus vorteilhafter.

La forme hexagonale du corps améliore les tolérances.

Elle répartit l'effort de façon plus uniforme sur la cage et les rouleaux.



STUD BOLT SETTER STEHBOLZENSETZER MONTE-GOUJONS



A special socket for installing a stud bolt.

Inside steel ball prevent the stud bolt stuck onto the socket. After installing a stud bolt, turn to anti-clockwise to removing the socket.

Spezialwerkzeug zum Setzen von Stehbolzen. Der Bolzen trifft im Werkzeug nur auf die gehärtete Stahlkugel, was die Kontaktfläche verringert. Nach dem Setzen des Stehbolzens kann das Werkzeug im Linkslauf vom Stehbolzen abgezogen werden.

Douilles spéciales pour monter les goujons. Le goujon est en contact avec une bille d'acier pour l'empêcher d'adhérer à la douille. Après avoir posé le goujon, tourner dans le sens antihorlogique pour le retirer

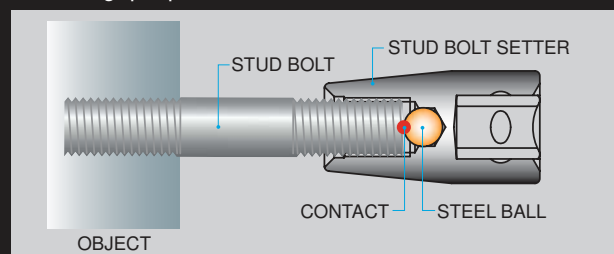



ATTACK DRIVER®

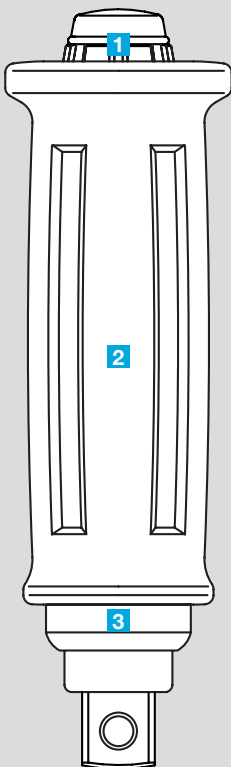

1 Black Finish - Schwarze Schlagplatte - Tête de frappe noire



Black finished head prevents peeling off the chrome plate by striking the head.
 Der Schlagkopf wurde geschwärzt, um das Abblättern von Chrompartikeln zu verhindern.

La finition noire de la tête évite l'écailage du chrome lors de la frappe.



2 Original Body Shape - Einzigartige Formgebung - Forme unique du corps



Original design of the body achieved higher grip.

Die Gestaltung des Handschlagschrauberkörpers erhöht Führung und Griffigkeit des Werkzeuges.

Le dessin original du corps permet une meilleure prise en main de l'outil.

1 3 Heat Treatment - Wärmbehandlung - Traitement thermique

Special heat treatment is applied on the body. Hardness of striking part is slightly softer to prevent cracks.

On the other hand, Cam part converts the striking power to twisted by striking with hammer, therefore, this part is finished with higher hardness to improve anti-wear.

Besondere Aufmerksamkeit wurde der Wärmbehandlung des Körpers gewidmet, indem die Härte des Schlagendes leicht verringert wurde, um ein Reißen durch Hammerschläge zu vermeiden. Dagegen wurde die Härte und somit die Belastbarkeit in dem Teil des Körpers erhöht, wo der Schlag in Drehkraft umgesetzt wird.

Un traitement thermique spécifique est appliqué sur le corps de l'outil. La dureté des parties de frappe est légèrement inférieure pour diminuer le risque de casse. D'un autre côté, le mécanisme qui transforme la force de frappe en rotation est plus dure pour augmenter la résistance à l'usure.

3 Spring - Feder - Ressort

Stronger spring is adapted to convert the striking power efficiently to twisting power.

Eine extrem widerstandsfähige Feder sorgt für die unmittelbare Übertragung der Schlagkraft und ihre Umsetzung in wirksame Drehkraft.

Un ressort très résistant est monté sur l'outil pour convertir la force de frappe en force de torsion très efficace.





FREE-TURN GRIP



SPINNING CROSS WRENCH DREHBARER KREUZSCHLÜSSEL CLE EN CROIX RAPIDE



The shaft of cross wrench turns freely inside the knurled grip. The cross bar is removable for easy storage in a compact space.

Der Schaft des Kreuzschlüssels dreht sich frei in dem kordierten Griff. Die Querstange kann entnommen werden, das erlaubt eine platzsparende Aufbewahrung (z.B. im Fahrzeug)

La tige de la clé tourne librement dans sa poignée gaufrée. La barre transversale est démontable pour le rangement aisé de l'outil.



FLEXIBLE SPEEDER GELENKGRIF-FWINDE VILEBREQUIN RAPIDE

Free-turn grip allows speedy removal or replacement of wheel nuts. It can also be used as a hinge handle to tighten or loosen the nuts.

Der frei laufende Griff ermöglicht eine schnelle Radmontage. Das Werkzeug kann zusätzlich als Gelenkgriff verwendet werden.

La poignée à rotation libre permet l'enlèvement et la pose rapide des écrous de roue. Elle peut également être utilisée comme poignée articulée.



SPINNING SLIDE T-HANDLE FREILAUF T-GRIFF POIGNEE EN T RAPIDE

The knurled grip is attached in the middle of shaft for free turning. Oval shaped cross bar prevents the bar from turning inside the shaft during use.

Der kordierte Freilauf-Griff befindet sich in der Mitte des Schaftes. Der Quergriff mit ovalem Querschnitt verhindert das Verrutschen.

La poignée gaufrée est fixée au milieu de la tige et est à rotation libre. La barre transversale est de forme ovale pour l'empêcher de tourner pendant l'utilisation.



IMPACT WHEEL NUT SOCKET IMPACT RADMUTTERN STECKSCHLÜSSEL DOUILLES POUR ÉCROUS DE ROUE, IMPACT



PLASTIC PROTECTOR KUNSTSTOFF HÜLSE PROTECTION EN PLASTIQUE



A detachable plastic protector is fitted to the socket to prevent damage to the wheel when working in tight areas.

The socket size and Ko-ken Mark printed on the shaft makes it easier to see if the socket is still rotating or stopped.

Zum Schutz empfindlicher Leichtmetallfelgen ist eine drehbare und abnehmbare Kunststoff Hülse an dem Steckschlüssel montiert. Die aufgedruckten Markierungen am Werkzeugschaft zeigen außerdem ob das Werkzeug steht oder rotiert.

La douille est pourvue d'un insert en plastique détachable. Il sert à prévenir tout dommage aux jantes lors de l'utilisation des douilles.

Le marquage sur la tige rend l'identification des douilles très facile.

EXTRA THIN-WALLED EXTRA DÜNNWANDIG PAROIS EXTRA MINCES



Thin-walled shape and 110mm length gives extra reach for nuts recessed deep inside the wheel.

They are ideal for aluminum wheel nuts where access to nut is very tight. Colour coded shafts make size identification easy.

SPARK PLUG SOCKET ZÜNDKERZEN STECKSCHLÜSSEL DOUILLES AVEC RESSORTS RETENUE POUR BOUGIES



CLIP TYPE

This revolutionary new spark plug socket is designed to securely grip a spark plug at its hexagonal part by two stainless spring clips.

An internal brass guide holds the clips in place, which ensures perfect alignment of the spark plug into the threaded plughole of the cylinder head, thus preventing thread damage.

The brass guide also eliminates stress loading and possible damage to the ceramic insulator of the spark plug.

Zwei solide Federn aus rostfreiem Stahl fassen den Sechskant der Zündkerze und drücken ihn an den Anschlag der Messing-Führungsbuchse. Jetzt sitzt die Kerze genau senkrecht zur Achse des Steckschlüssels. Das Einschrauben kann ohne Beschädigung der Gewindegänge im Motorblock und ohne Druck auf den Isolator der Kerze erfolgen.

Deux puissants ressorts en acier inoxydable maintiennent la bougie sur sa partie hexagonale tout en l'appliquant contre la douille de guidage en laiton. L'alignement parfait de la bougie dans l'axe de l'outil permet à l'opérateur de poser celle-ci avec beaucoup de précision en réduisant au maximum les risques d'endommagement au filetage du bloc ainsi qu'à la partie en céramique de la bougie.

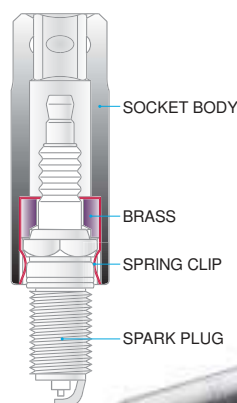



Universal Joint Universal Gelenk Joint universel



Hexahedral engagement achieved with compact design

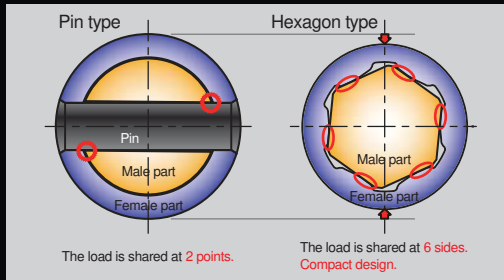

Ball type universal joints use a new structure of joint mechanism without a pin. Being connected by mutually engaged hexahedrons, the load is dispersed across the whole outer circumference. High durability is obtained with this innovative, compact design.

Unsere neuen Kugelgelenke haben einen Gelenkmechanismus ohne Bolzen. Durch die miteinander verbundenen sechs Flächen wird die Last über den gesamten Außenumfang verteilt. Diese innovative kompakte Bauweise erhöht die Lebensdauer des Gelenkes erheblich.

Nos joints articulés utilisent un nouveau mécanisme d'articulation sans boulons. Grâce aux six surfaces interconnectés, la charge est répartie sur toute la circonférence extérieure. Cette conception innovante et compacte augmente considérablement la durée de vie de l'articulation.



Locking Adaptor VERRIEGELUNGSADAPTER L'ADAPTATEUR DE VERROUILLAGE



Impact sockets can be attached or detached on the LOCKING ADAPTOR for safety just by sliding the holder rather than using a pin and an O-ring. It can reduce the time to change a socket, especially when you need to use a variety of socket sizes.

Die Kraftschraubereinsätze werden durch einfaches Verschieben der Hülse am Adapter, ohne Verwendung von Stift und O-Ring, sicher gehalten bzw. entriegelt. Die Zeit für den Wechsel eines Steckschlüssels wird dadurch deutlich verkürzt, insbesondere wenn Sie eine Vielzahl von verschiedenen Abmessungen verwenden müssen.

Vos douilles à chocs peuvent être facilement maintenues et libérées en déplaçant le support de l'adaptateur sans devoir utiliser la goupille et le joint. Le temps nécessaire pour changer une clé à douille est considérablement réduit, surtout si vous devez utiliser une variété de dimensions différentes.

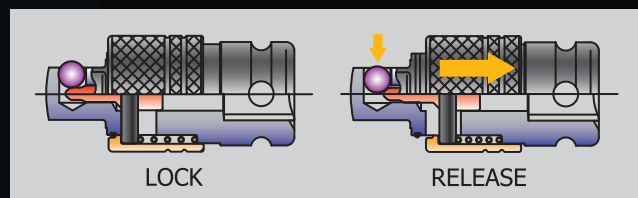



NUTTWISTER®



The NUTTWISTER's six teeth have a special helical structure that tapers inward, locking onto the rounded-off bolt or nut for removal. NUTTWISTER can be applied to any round bolts like stud bolts, cap bolts, provided the correct size is used and the bolt or nut is unbroken.

Die sechs Zähne des NUTTWISTER's haben eine spezielle schraubenförmige Struktur, die sich nach innen verjüngt und sich dadurch mit der abgerundeten Schraube oder Mutter verbeißt.

Der NUTTWISTER kann auf alle Rundbolzen wie Stehbolzen und Zylinderschrauben verwendet werden, unter Voraussetzung dass die richtige Größe verwendet wird und die zu lösende Schraube oder Mutter nicht gebrochen ist.

Les six dents du NUTTWISTER ont une structure hélicoïdale spéciale qui se rétrécit vers l'intérieur et mord avec la vis ou l'écrou arrondi.

Le NUTTWISTER peut être utilisé sur tous les boulons ronds tels que les boulons filetés et les vis à tête cylindrique, à condition que la taille correcte soit utilisée et que la vis ou l'écrou à desserrer ne soit pas cassé.

BOLTTWISTER®



Use the BOLTTWISTER to remove a broken bolt whose head has come off.

After drilling a hole in the center of the broken bolt, insert BOLTTWISTER into the hole and turn it counterclockwise until it sticks. The bolt can be removed by continuing to turn it.

Verwenden Sie unsere BOLTTWISTER um gebrochene Schrauben deren Kopf abgebrochen ist zu lösen.

Nachdem Sie ein Loch in der Mitte des gebrochenen Bolzens gebohrt haben, stecken Sie den BOLTTWISTER in das Loch und drehen ihn gegen den Uhrzeigersinn bis er klemmt.

Der Bolzen kann nun durch weiteres Drehen entfernt werden.

Utilisez notre BOLTTWISTER pour enlever une vis cassée dont la tête est cassée.

Après avoir percé un trou au centre du boulon cassé, insérez le BOLTTWISTER dans le trou et tournez le dans le sens inverse des aiguilles d'une montre jusqu'à ce qu'elle se bloque.

Le boulon peut maintenant être retiré en le tournant davantage.

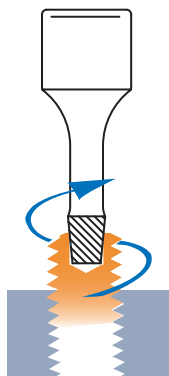

TORX® / TORXplus® & LHSTIX®

TORX® / TORXplus® and **LHSTIX®** are recognized as three of the most efficient fastening systems because of their ability to transfer greater torque, reduce end load and virtually eliminate tool slippage.

Durch die Fähigkeit größere Drehmomente zu übertragen sind **TORX® / TORXplus®** und **LHSTIX®** bekannt als die drei effizientesten Befestigungssysteme.

TORX® / TORXplus® et **LHSTIX®** sont reconnus comme étant trois systèmes de vissage particulièrement efficaces. Ils permettent en effet de transmettre des couples particulièrement élevés.

TORX® & TORX plus®



TORX® is a registered trademark of CAMCAR Innovations.
TORX® ist ein registriertes Markenzeichen der Firma CAMCAR Innovations.
TORX® est une marque déposée de CAMCAR Innovations.
TORXplus® is a registered trademark of CAMCAR Innovations.
TORXplus® ist ein registriertes Markenzeichen der Firma CAMCAR Innovations.
TORXplus® est une marque déposée de CAMCAR Innovations.



Koken TOOL CO., LTD. holds the official license to use the trademark **TORX®**.
Koken TOOL CO., LTD. hält die offizielle Lizenz um das Markenzeichen **TORX®** benutzen zu dürfen.
Koken TOOL CO., LTD. est officiellement licencié pour l'usage de cette marque **TORX®**.
Koken TOOL CO., LTD. holds the official license to use the trademark **TORXplus®**.
Koken TOOL CO., LTD. hält die offizielle Lizenz um das Markenzeichen **TORXplus®** benutzen zu dürfen.
Koken TOOL CO., LTD. est officiellement licencié pour l'usage de cette marque **TORXplus®**.

LHSTIX®

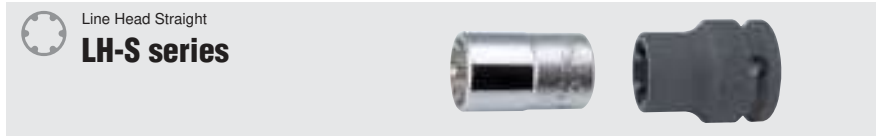

LHSTIX® is a registered trademark of OSG SYSTEM PRODUCTS CO., LTD.
LHSTIX® ist ein registriertes Markenzeichen der Firma OSG SYSTEM PRODUCTS CO., LTD.
LHSTIX® est une marque déposée de OSG SYSTEM PRODUCTS CO., LTD.
Koken TOOL CO., LTD. holds the official license to use the trademark **LHSTIX®**.
Koken TOOL CO., LTD. hält die offizielle Lizenz um das Markenzeichen **LHSTIX®** benutzen zu dürfen.
Koken TOOL CO., LTD. est officiellement licencié pour l'usage de cette marque **LHSTIX®**.

Registered Trademarks / Eingetragene Warenzeichen / Marque déposée

Koken®



Koken TOOL CO., LTD.®

HIGH PERFORMANCE TOOLS OF CONVINCING QUALITY

山下工業研究所®

山下工研®

SODH®-System

Flatdrive®

ATTACK DRIVER®

HANDY-ENDY®

PATHFINDER®

Nut Grip®

LOCK NUT BUSTER®

NUT TWISTER®

BOLT TWISTER®



Warranty / Garantie / Garantie

WARRANTY

The trade mark **Koken** is your unqualified warranty against any defect in material or workmanship. Each **Koken** tool is built to more than meet the requirements of its intended use and is carefully checked before leaving the factory. Any **Koken** tool which fails because of defective material or workmanship will be repaired or replaced through your **Koken** dealer, to the exclusion of any further liability.

GARANTIE

Koken TOOL CO.,LTD. Shizuoka, Japan, garantit Ihnen die einwandfreie Qualität und Ausführung ihrer Produkte. Jedes Werkzeug der Marke **Koken** ist für Höchstleistungen konstruiert und wird vor Verlassen der Fabrik sorgfältig geprüft. **Koken** TOOL CO.,LTD. repariert oder ersetzt über ihre Händler unter Ausschluss jeglicher weitergehenden Haftung jedes fehlerhafte **Koken** Produkt kostenlos.

GARANTIE

La fabrique **Koken** TOOL CO.,LTD. Shizuoka, Japon, garantit la qualité irréprochable et le traitement absolument impeccable des outils portant la marque **Koken**. Chaque outil **Koken** quittant la fabrique est contrôlé soigneusement. La fabrique s'engage à réparer ou remplacer gratuitement tout défaut de matière ou de fabrication par l'intermédiaire de ses distributeurs, à l'exception d'une responsabilité étendue.

ISO9001







**SAFETY
ADVISER**

**SICHERHEITS-
RATGEBER**

**MESURES
DE SÉCURITÉ**

General / Allgemeines / Généralités

- (a) Make sure you use the right type socket, whose opening fit the nut.
Verwenden Sie immer den richtigen Steckschlüssel und überzeugen Sie sich davon, ob er auch auf die Mutter passt.
Utilisez toujours la bonne clé et assurez-vous qu'elle est rigoureusement adaptée à l'écrou.
- (b) For use on electric or air IMPACT Wrenches select IMPACT Sockets only.
Auf elektrischen oder pneumatischen Schlagschraubern dürfen nur hoch belastbare IMPACT-Steckschlüssel und Zubehörteile gesteckt werden.
Sur des vis à fixer par machines à chocs pneumatiques ou électriques n'utilisez que des clés à douille IMPACT et des accessoires IMPACT capables de résister à une haute sollicitation.
- (c) When using nut runners or IMPACT Wrenches wear safety goggles.
Tragen Sie bei der Anwendung von Schraubern stets eine Schutzbrille.
En opérant avec des visseuses et des machines à chocs, portez toujours des lunettes de protection.
- (d) Plastic or rubber handles are not intended to act as insulation.
Plastik-oder Gummigriffe stellen keinen Isolierschutz dar.
Les poignées en plastique ou en caoutchouc ne garantissent aucune isolation électrique.
- (e) Never substitute a HAND Socket for a INDUSTRIAL Socket or an IMPACT Socket, or a INDUSTRIAL Socket for an IMPACT Socket.
Nehmen Sie deshalb niemals anstelle eines INDUSTRIAL-oder IMPACT-Werkzeuges ein HAND-Werkzeug oder anstatt eines IMPACT-Werkzeuges ein INDUSTRIAL-Werkzeug.
Ne vous servez donc jamais d'un outil à main au lieu d'un outil INDUSTRIAL ou IMPACT ou d'un outil INDUSTRIAL au lieu d'un outil IMPACT.
- (f) Items in this catalogue marked  can be loaded to torque values which may cause breakage. In the interest of your own safety always apply load evenly and progressively to avoid breakage and possible injury.
Die mit  gekennzeichneten Artikel können bei Überbelastung zu Bruch gehen. Aus Gründen Ihrer eigenen Sicherheit sollten die betreffenden Werkzeuge nie ruckartig, sondern nach und nach belastet werden, um Bruch, und damit verbundene mögliche Verletzungen zu vermeiden.
Il est possible d'appliquer aux articles marqués  des couples de serrage susceptibles d'occasionner leur rupture. Pour votre propre sécurité, veuillez toujours appliquer la charge d'une manière uniforme et progressive. Ceci pour éviter ruptures et accidents.
- (g) Make sure to lock the impact sockets on driving tools with Pin / O-Ring or C-Ring.
Verwenden Sie Impact Steckschlüssel nie ohne Sicherungsring und Stift oder alternativ mittels unserer C-Ringe.
Ne jamais utiliser de douille à choc sans sécurité. (Anneau et goupille ou crochet en C)

Sockets / Steckschlüssel / Douilles

Sockets showing cracked walls, battered points or other marks of wear are to be replaced.

Steckschlüssel mit Haarrissen, abgestossenen Kanten oder mit anderen Verbraucherscheinungen sind umgehend zu ersetzen.

Les clés qui présentent des fissures capillaires, ou autres signes d'usure doivent être immédiatement changées.

Ratchets/Handles / Knarren/Griffe / Cliquets/Poignées

A ratchet is not a hammer.

Eine Knarre ist kein Hammer.

Un cliquet n'est pas un marteau.

Never use loose pipes or other improvised attachments on handles for increased leverage.

Setzen Sie niemals lose Rohre oder andere Hilfsstücke auf Steckschlüsselgriffe, um dadurch eine höhere Drehkraft zu erzeugen.

Ne mettez jamais de tubes ou autres pièces auxiliaires sur les poignées des clés à douille dans le but d'obtenir un couple de serrage plus élevé.

Extension Bars / Verlängerungen / Rallonges

The combination of several short extensions instead of one correct sized one is to be avoided.

Das Zusammenstecken von mehreren kurzen Verlängerungen als Ersatz für eine in der richtigen Länge ist unbedingt zu vermeiden.

Il faut absolument éviter d'utiliser plusieurs rallonges courtes au lieu d'une seule ayant la bonne longueur.

Adaptors / Verbindungsstücke / Réducteurs

Adaptors are to be used reasonably. Be reminded that high torque potentials are reached when using a "down" adaptor, a bigger sized handle to a smaller drive socket. Always stay within safe limits.

Reduzierstücke sind mit Vernunft einzusetzen. Beachten Sie, dass bei der Verwendung von Reduzierstücken hohe Drehmomentwerte ausgelöst werden nämlich dadurch, dass grössere Griffe auf kleinere Steckschlüssel gesetzt werden. Bleiben Sie jeweils innerhalb der Sicherheitsgrenzen.

Les réducteurs doivent être utilisés avec modération. Il est à considérer qu'avec les réducteurs on obtient un couple de serrage élevé du fait que des poignées plus grandes sont appliquées sur des clés à douille plus petites. Ne dépassez pas les limites de sécurité.

Koken

**Z-SERIES
Z-SERIE
SERIES-Z**



Z-Series : Feature



COMPACT

2400MZ and 3400MZ are designed 5-9mm shorter than standard 2400M and 3400M which is ideal for working in confined and tight areas.

2400MZ und 3400MZ sind gegenüber unseren Standardausführungen 2400M und 3400M um 5-9mm kürzer. Dies erlaubt ein Arbeiten an schwer zugänglichen Stellen.

Les douilles 2400MZ et 3400MZ étant plus courtes de 5-9mm par rapport aux douilles standards, elles ont l'avantage de faciliter le travail dans des endroits étroits et difficilement accessibles.

TOLERANCE-Hexagon Opening

The Hexagon openings of our Z-Sockets are produced with reduced tolerances (according to DIN/ISO) which achieve a more positive fit between bolt and socket.

Die Steckschlüsselöffnungen der Z-Serie werden mit geringeren Toleranzen (nach DIN/ISO) gefertigt um eine bessere, direktere Verbindung zwischen Schraube und Werkzeug zu gewährleisten.

Les douilles Ko-ken de la série Z sont fabriquées selon DIN/ISO comme toutes les douilles standards. Sauf que pour la série Z les tolérances sont plus restreintes afin d'atteindre un meilleur ajustement entre douille et vis.

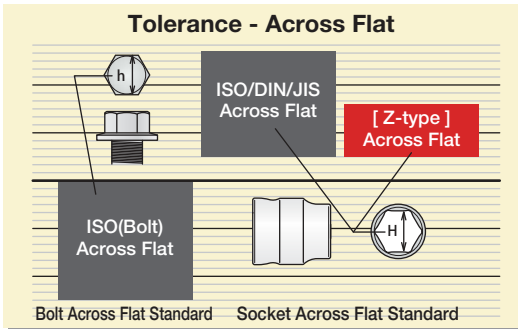

TOLERANCE-Square Drive

To ensure a tighter fit between socket and handle, the male and female square drives are produced with shorter tolerances (according DIN/ISO).

Auch die Antriebsvierkante sind mit einer geringeren Toleranz (nach DIN/ISO) gefertigt um eine festere Verbindung zwischen Betätigungswerkzeug und Steckschlüssel zu ermöglichen.

Aussi les carrés mâles et femelles sont fabriqués avec des tolérances plus restreintes (selon DIN/ISO) afin de garantir une meilleure fixation entre cliquet et douille.

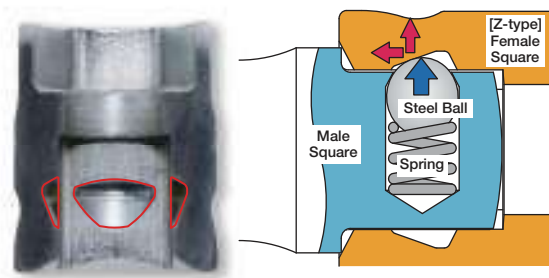
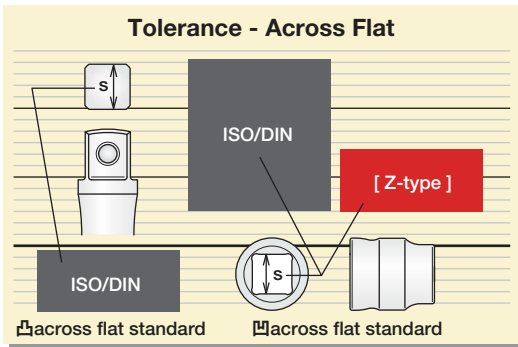

BALL HOLDING GROOVE

The inventive Ball Holding system of the Z-series allows a secure connection between Socket and Handle.

Die Werkzeuge der Z-Serie verfügen über spezielle Kugelfangrillen, die eine noch sicherere Verbindung zwischen Betätigungswerkzeug und Steckschlüssel gewährleisten.

La série Z dispose d'une rainure de fixation pour bille spéciale, qui améliore nettement la fixation entre douille et cliquet.



RATCHET HANDLE

Smaller head with 72/36 tooth gear and light ratchet movement allow working in narrow spaces and confined areas.

Der schmalere Knarrenkopf, mit leicht gängigem 72/36-Zahn Getriebe erlaubt ein Arbeiten an engen schwer zugänglichen Stellen.

La tête de cliquet réduit et un mécanisme à 72/36 dents plus léger facilite le travail dans des endroits difficilement accessibles.

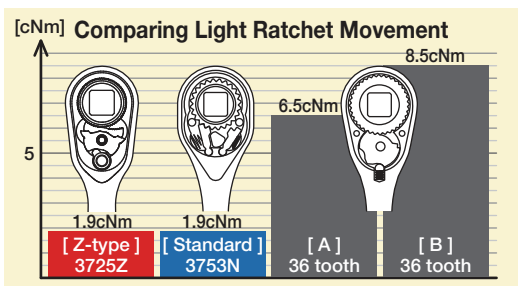

* A, B : Other Brand

2400MZ (mm)	D ₁ (mm)	D ₂ (mm)	H (mm)	L (mm)	(g)	(pcs.)
4	6.4	11	3	14	6	10
4.5	7	11	3	14	6	10
5	7.6	11	3	14	6	10
5.5	8.2	11	3.5	14	6	10
6	8.8	11	3.5	14	6	10
7	9.9	11	3.5	14	6	10
8	11.1	11.7	4.5	15	7	10
10	13.5	12.5	7	15	8	10
11	14.7	13.2	7	15	9	10
12	15.9	14.4	7	15	11	10
13	17.1	15.6	7	15	14	10
14	18.3	16.8	7	15	16	10



2400MZ 6-point Sockets
6-kant Steckschlüssel
Douilles 6-pans

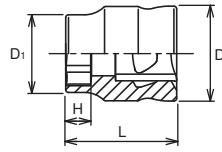

RS2400MZ/12	12 Pieces Set/Rail 200mm	(g)
4, 4.5, 5, 5.5, 6, 7, 8, 10, 11, 12, 13, 14		228

RS2400MZ/12 Socket Set on magnetic Rail
Steckschlüsselsatz auf Magnetschiene
Jeu de douilles sur rail à aimant



2300XZ (mm)	D ₁ (mm)	D ₂ (mm)	H ₁ (mm)	H ₂ (mm)	L (mm)	(g)	(pcs.)
5.5	8.2	11	6	20	30	10	10
6	8.8	11	7	20	30	10	10
7	9.9	11	8	20	30	11	10
8	11.1	11.7	9	20	30	13	10
10	13.5	12.5	11	20	30	16	10
11	14.7	13.2	12	20	30	19	10
12	15.9	14.4	13	20	30	22	10
13	17.1	15.6	14	20	30	26	10
14	18.3	16.8	14	20	30	30	10

2300XZ 6-point Sockets, Semi-Deep
6-kant Steckschlüssel, mittel-lang
Douilles, semi-profondes 6-pans

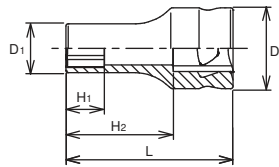

RS2300XZ/9	9 Pieces Set/Rail 200mm	(g)
5.5, 6, 7, 8, 10, 11, 12, 13, 14		290

RS2300XZ/9 Socket Set on magnetic Rail
Steckschlüsselsatz auf Magnetschiene
Jeu de douilles sur rail à aimant



2300MZ (mm)	D ₁ (mm)	D ₂ (mm)	H ₁ (mm)	H ₂ (mm)	L (mm)	(g)	(pcs.)
4	6.4	11	5	41	50	14	10
4.5	7	11	5.5	41	50	16	10
5	7.6	11	6	41	50	16	10
5.5	8.2	11	6.5	41	50	16	10
6	8.8	11	7	41	50	17	10
7	9.9	11	8	41	50	20	10
8	11.1	11.7	9	41	50	22	10
10	13.5	12.5	11	41	50	29	10
11	14.7	13.2	12	41	50	33	10
12	15.9	14.4	13	41	50	40	10
13	17.1	15.6	14	41	50	45	10
14	18.3	16.8	16	41	50	51	10

2300MZ 6-point Deep Sockets
6-kant-Steckschlüssel, lang
Douilles longues 6-pans

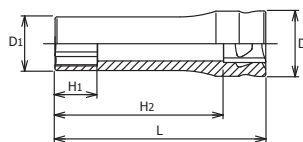

RS2300MZ/12	12 Pieces Set/Rail 200mm	(g)
4, 4.5, 5, 5.5, 6, 7, 8, 10, 11, 12, 13, 14		445

RS2300MZ/12 Socket Set on magnetic Rail
Steckschlüsselsatz auf Magnetschiene
Jeu de douilles sur rail à aimant



Z-SERIES
HAND
TITANIUM
SCREWDRIVERS
ACCESSORIES
IMPACT
SLEEVE-DRIVE
PROTECTOR
INDUSTRIAL
AUTOMOTIVE
MOTORCYCLE
CONSTRUCTION
SPARE PART

2000Z-28 / -50

 PH Bit Sockets
Steckschlüssel für Kreuzschlitzschrauben, PH
Douilles tournevis pour vis à empreinte PH

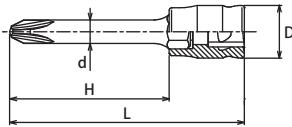

2000Z-28 (PH)	D (mm)	H (mm)	L (mm)	(g)	(pcs.)
1	11.2	12	28	9	10
2	11.2	12	28	10	10
3	11.2	12	28	10	10

2000Z-50 (PH)	D (mm)	d (mm)	H (mm)	L (mm)	(g)	(pcs.)
1	11.2	4	34	50	11	10
2	11.2	5	34	50	13	10
3	11.2	-	34	50	16	10

2005Z-25

 Bit Sockets for Slotted Head
Steckschlüssel für Schlitzschrauben
Douilles tournevis pour vis à fente

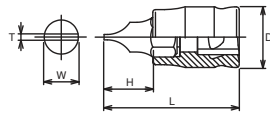

2005Z-25	T x W (mm)	D (mm)	H (mm)	L (mm)	(g)	(pcs.)
5	1.0 x 5.5	11.2	9	25	9	10
6	1.2 x 6.5	11.2	9	25	10	10

2010MZ-25 / -50



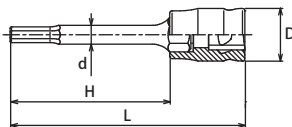

 Inhex Bit Sockets
Steckschlüssel für Innensechskant-Schrauben
Douilles tournevis pour vis 6-pans creux



2010MZ-25 (mm)	D (mm)	H (mm)	L (mm)	(g)	(pcs.)
3	11.2	9	25	9	10
4	11.2	9	25	9	10
5	11.2	9	25	10	10
6	11.2	9	25	10	10

2010MZ-50 (mm)	D (mm)	d (mm)	H (mm)	L (mm)	(g)	(pcs.)
3	11.2	4	34	50	11	10
4	11.2	5	34	50	13	10
5	11.2	6	34	50	15	10
6	11.2	-	34	50	17	10

RS20XXZ/9

    Socket Set on magnetic Rail
Steckschlüsselsatz auf Magnetschiene
Jeu de douilles sur rail à aimant



RS20XXZ/9		9 Pieces Set/Rail 200mm	(g)
2000Z.28		1, 2, 3	213
2005Z.25		5, 6	
2010MZ.25		3, 4, 5, 6	

1/4"

Z-series
Z-serie
Series-Z

2025Z-28 (T)	D (mm)	H (mm)	L (mm)	(g)	(pcs.)
T10	11.2	12	28	9	10
T15	11.2	12	28	9	10
T20	11.2	12	28	9	10
T25	11.2	12	28	10	10
T27	11.2	12	28	10	10
T30	11.2	12	28	10	10
T40	11.2	12	28	11	10

2025Z-50 (T)	D (mm)	d (mm)	H (mm)	L (mm)	(g)	(pcs.)
T10	11.2	4	34	50	11	10
T15	11.2	4	34	50	11	10
T20	11.2	4.5	34	50	12	10
T25	11.2	5	34	50	13	10
T27	11.2	5	34	50	13	10
T30	11.2	5.6	34	50	15	10
T40	11.2	-	34	50	17	10

RS2025Z/7-L28	7 Pieces Set/Rail 200mm	(g)
T10, T15, T20, T25, T27, T30, T40		195

RS2025Z/7-L50	7 Pieces Set/Rail 200mm	(g)
T10, T15, T20, T25, T27, T30, T40		220

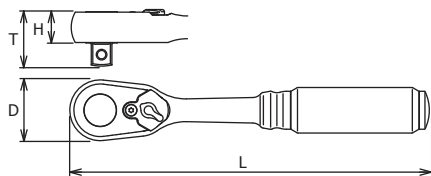

36

	D (mm)	T (mm)	H (mm)	L (mm)	(g)	(pce.)
2725Z	20.5	17.1	9.5	114	79	1
2725Z-160	20.5	17.1	9.5	160	120	1

* Renewal Kits → 2725RK → P308

⚠ 2725Z-160 have longer handle than standard, and can be loaded to excessive torque value. In the interest of your own safety always apply load evenly and progressively to avoid breakage and possible injury.



2725Z
2725Z-160 ⚠
Reversible Ratchet
Knarre, verstellbar
Cliquet, réversible

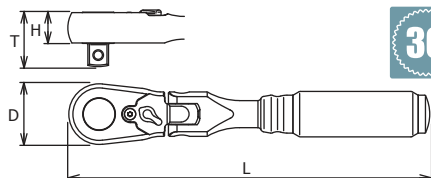

36
Flexible Head

	D (mm)	T (mm)	H (mm)	L (mm)	(g)	(pce.)
2726Z	20.5	17.1	9.5	114	103	1
2726Z-160	20.5	17.1	9.5	160	150	1

* Renewal Kits → 2725RK → P308

⚠ 2726Z-160 have longer handle than standard, and can be loaded to excessive torque value. In the interest of your own safety always apply load evenly and progressively to avoid breakage and possible injury.



2726Z
2726Z-160 ⚠
Flexible Ratchet, Reversible (Short)
Gelenk-Knarre kurz, verstellbar
Cliquet articulé court, réversible

2025Z-28 / -50

TORX® Bit Sockets
TORX® Bit-Steckschlüssel
Douilles tournevis, TORX®

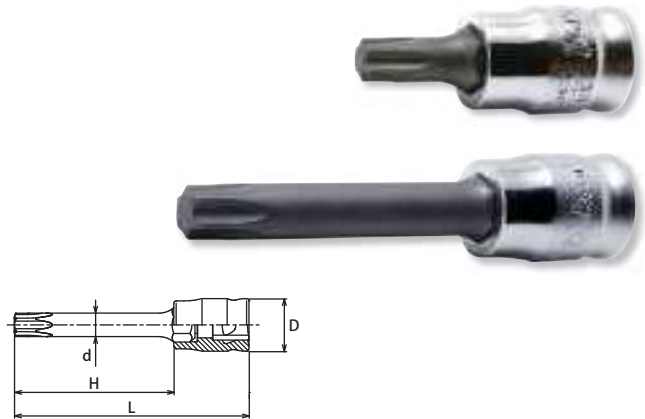

RS2025Z/7-L28 RS2025Z/7-L50

Socket Set on magnetic Rail
Steckschlüsselsatz auf Magnetschiene
Jeu de douilles sur rail à aimant



2760Z

Extension Bars
Verlängerungen
Rallonges

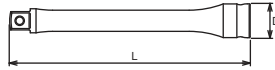

	D (mm)	L (mm)	(g)	(pcs.)
2760Z-50	11.5	50	21	10
2760Z-100	11.5	100	39	10
2760Z-150	11.5	150	58	10

2771Z

Universal Joint
Gelenk-Einsatz
Joint articulé

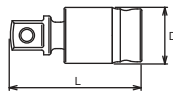

	D (mm)	L (mm)	(g)	(pcs.)
2771Z	11.7	29.9	15	10

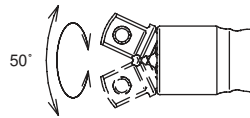

2772Z

Universal Double Joint
Doppelgelenk-Einsatz
Joint articulé double

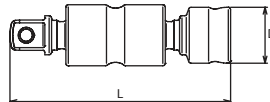

	D (mm)	L (mm)	(g)	(pcs.)
2772Z	11.7	46	26	10

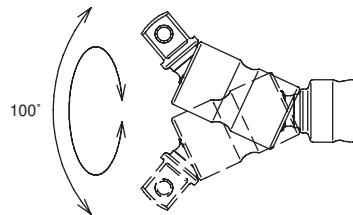

2756Z

Quick Spinner
Rändel-Drehscheibe
Lanceur



	D (mm)	L (mm)	(g)	(pcs.)
2756Z	20.3	18	15	10

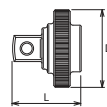

2756Z-3/8

Quick Spinner, Adaptor
Rändel-Drehscheibe als Adaptor
Lanceur, adaptateur









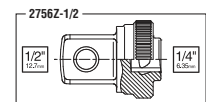
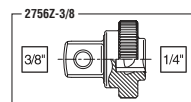
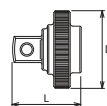

2756Z-3/8

2756Z-1/2



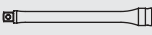

	D (mm)	L (mm)	(g)	(pcs.)
2756Z-3/8	20.3	21.5	24	10
2756Z-1/2	20.3	26	35	10



P2285Z		26 Pieces Set/△△=660g	
PLASTIC CASE:W245×H120×T45			
Sockets	Accessories		
 2400MZ 6-pt. Sockets 4, 4.5, 5, 5.5, 6, 7, 8, 10, 11,12, 13, 14		2725Z	
		2756Z	
 2000Z.28 1, 2, 3		2771Z	
 2005Z.25 5, 6		2760Z-50	
 2010MZ.25 3, 4, 5, 6		2760Z-150	



P2285Z Set in PE-foam tray
Steckschlüsselsatz in Weichschaumeinlage
Set disposé dans boîte de rangement en mousse souple

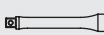
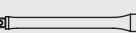

2286Z		17 Pieces Set/△△=780g	
BLACK METAL CASE:W240×H100×T32mm			
Sockets	Accessories		
 2400MZ 6-pt. Sockets 4, 5, 5.5, 6, 7, 8, 10, 11, 12, 13, 14		2725Z	
		2756Z	
		2771Z	
		2760Z-50	
		2760Z-100	
		2760Z-150	

2286Z Set in PE-foam tray
Steckschlüsselsatz in Weichschaumeinlage
Set disposé dans boîte de rangement en mousse souple



2285ZE		10 Pieces Set/△△=300g	
Rail 200mm/PLASTIC BAG			
Sockets	Accessories		
 2400MZ 6-pt. Sockets 5.5, 6, 7, 8, 10, 12, 13, 14		2725Z	
		2756Z	

2285ZE Socket Sets
Steckschlüssel Sätze
Jeu de clés à douilles



3400MZ

6-point Sockets
6-kant Steckschlüssel
Douilles 6-pans

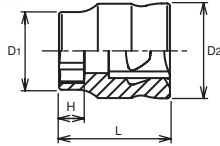

3400MZ (mm)	D ₁ (mm)	D ₂ (mm)	H (mm)	L (mm)	(g)	(pcs.)
5.5	8.5	17	3.5	19	16	10
6	9.1	17	3.5	19	17	10
7	10.3	17	3.5	19	17	10
8	11.5	17	4.5	20	17	10
10	14	17	4.5	20	18	10
11	15.3	17	5.5	21	18	10
12	16.5	17	5.5	21	19	10
13	17.8	17	8.5	21	19	10
14	19	17	8.5	21	20	10
15	20.2	18.2	8.5	21	24	10
16	21.3	19.3	8.5	21	28	10
17	22.5	20.5	8.5	21	32	10
18	23.6	21.6	9.5	22	38	10
19	24.8	22.8	9.5	22	41	10
21	27	25	10.5	23	51	10
22	28.3	26.3	10.5	23	58	10

3400MZ is designed 5-9mm shorter than standard 3400M.
Ideal for working in confined and tight areas.

RS3400MZ/8 RS3400MZ/12

Socket Set on magnetic Rail
Steckschlüsselsatz auf Magnetschiene
Jeu de douilles sur rail à aimant



RS3400MZ/8	8 Pieces Set/Rail 200mm	(g)
8, 10, 11, 12, 13, 14, 17, 19		320

RS3400MZ/12	12 Pieces Set/Rail 300mm	(g)
7, 8, 10, 11, 12, 13, 14, 15, 16, 17, 18, 19		490

3300XZ

6-point Sockets, Semi-Deep
6-kant Steckschlüssel, mittel-lang
Douilles, semi-profondes 6-pans

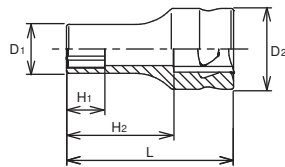

3300XZ (mm)	D ₁ (mm)	D ₂ (mm)	H ₁ (mm)	H ₂ (mm)	L (mm)	(g)	(pcs.)
7	10.3	17	8	23	35	23	10
8	11.5	17	9	23	35	24	10
10	14	17	11	23	35	26	10
11	15.3	17	12	23	35	28	10
12	16.5	17	13	23	35	29	10
13	17.8	17	14	23	35	32	10
14	19	17	16	23	35	34	10
15	20.2	18.2	16	23	35	40	10
16	21.3	19.3	16.5	23	35	45	10
17	22.5	20.5	16.5	23	35	50	10
18	23.6	21.6	16.5	23	35	56	10
19	24.8	22.8	18	23	35	60	10

RS3300XZ/8 RS3300XZ/12

Socket Set on magnetic Rail
Steckschlüsselsatz auf Magnetschiene
Jeu de douilles sur rail à aimant



RS3300XZ/8	8 Pieces Set/Rail 200mm	(g)
8, 10, 11, 12, 13, 14, 17, 19		420

RS3300XZ/12	12 Pieces Set/Rail 300mm	(g)
7, 8, 10, 11, 12, 13, 14, 15, 16, 17, 18, 19		630

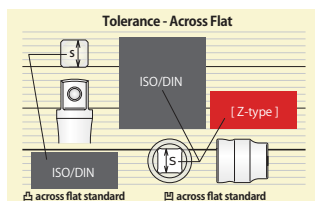
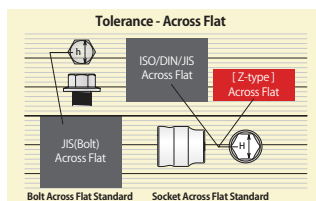

Manufacturing tolerance is precisely controlled to achieve a secure fitting.

BALL HOLDING GROOVE

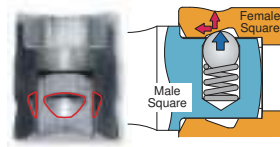

The inventive Ball Holding system of the Z-series allows a secure connection between Socket and Handle.

Die Werkzeuge der Z-Serie verfügen über spezielle Kugelfangrillen, die eine noch sicherere Verbindung zwischen Betätigungswerkzeug und Steckschlüssel gewährleisten.

La série Z dispose d'une rainure de fixation pour bille spéciale, qui améliore nettement la fixation entre douille et cliquet.

3300MZ (mm)	D ₁ (mm)	D ₂ (mm)	H ₁ (mm)	H ₂ (mm)	L (mm)	(g)	(pcs.)
7	10.3	17	8	41.5	55	29	10
8	11.5	17	9	41.5	55	34	10
10	14	17	11	41.5	55	43	10
11	15.3	17	12	41.5	55	45	10
12	16.5	17	13	41.5	55	49	10
13	17.8	17	14	41.5	55	52	10
14	19	17	16	41.5	55	55	10
15	20.2	18.2	16	40.5	55	65	10
16	21.3	19.3	17	40.5	55	74	10
17	22.5	20.5	18	40.5	55	83	10
18	23.6	21.6	19	39.5	55	90	10
19	24.8	22.8	20	39.5	55	95	10

RS3300MZ/8	8 Pieces Set/Rail 200mm	(g)
8, 10, 11, 12, 13, 14, 17, 19		600

RS3300MZ/12	12 Pieces Set/Rail 300mm	(g)
7, 8, 10, 11, 12, 13, 14, 15, 16, 17, 18, 19		900

RS3X00MZ/12	12 Pieces Set/Rail 300mm	(g)
3400MZ	8, 10, 11, 12, 13, 14, 17, 19	550
3300MZ	8, 10, 12, 14	

3300CZ (mm)	D (mm)	H ₁ (mm)	H ₂ (mm)	L (mm)	(g)	(pcs.)
14	18.4	11	17	70	67	10
16	20.5	13	17	70	71	10
18	22.9	12	17	70	75	10
20.8	26.3	13.5	17	70	105	10

Slim & light weight body with smaller outside diameter for work in tight spaces.

⚠ Spring clip type spark plug sockets caused deforming the clip if it would be used with shallow engagement.



3305PZ (mm)	D (mm)	H ₁ (mm)	H ₂ (mm)	L (mm)	(g)	(pcs.)
14	17.9	8	17	70	56	10
16	20	8	17	70	55	10

Spark Plug Socket with Magnet, 12-pt. opening: size 14mm



⚠ The magnet could be broken with any impacts. Please handle with care.

3300MZ

6-point Deep Sockets
6-kant-Steckschlüssel, lang
Douilles longues 6-pans

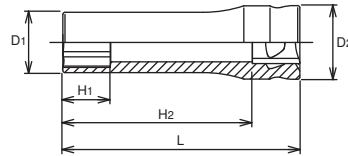

RS3300MZ/8

Socket Set on magnetic Rail
Steckschlüsselsatz auf Magnetschiene
Jeu de douilles sur rail à aimant

RS3300MZ/12



RS3X00MZ/12

Socket Set on magnetic Rail
Steckschlüsselsatz auf Magnetschiene
Jeu de douilles sur rail à aimant



3300CZ

Spark Plug Sockets with Spring Clips
Zündkerzen-Schlüssel mit Haltefeder
Douilles avec ressorts de retenues pour bougies

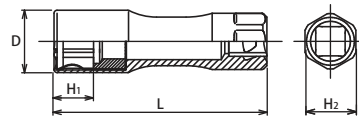

3305PZ

Spark Plug Socket with Magnet, 12-pt. opening
Zündkerzensteckschlüssel mit Magnet, 12-kant
Douille pour bougies, avec aimant, 12-pans

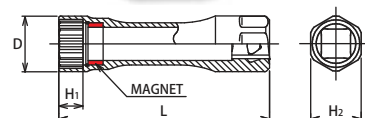

3010MZ-50 / -75

 Inhex Bit Sockets
Steckschlüssel für Innensechskant-Schrauben
Douilles tournevis pour vis 6-pans creux

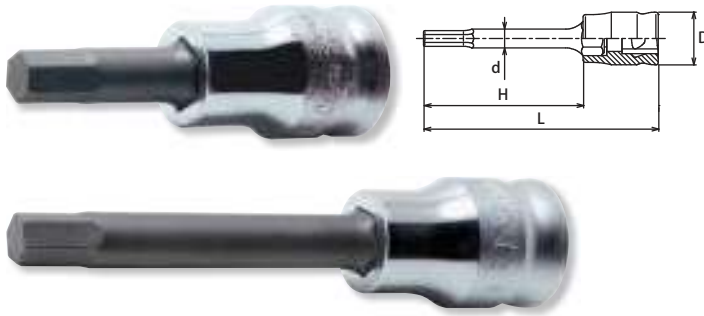

3010MZ-50 (mm)	D (mm)	d (mm)	H (mm)	L (mm)	(g)	(pcs.)
3	17	4	23.5	50	28	10
4	17	5	23.5	50	29	10
5	17	6	23.5	50	30	10
6	17	7	23.5	50	35	10
7	17	-	23.5	50	38	10
8	17	-	23.5	50	40	10
10	17	-	23.5	50	50	10
12	19	-	23.5	50	70	10

3010MZ-75 (mm)	D (mm)	d (mm)	H (mm)	L (mm)	(g)	(pcs.)
3	17	6	48.5	75	33	10
4	17	6	48.5	75	35	10
5	17	6	48.5	75	36	10
6	17	7	48.5	75	41	10
7	17	7.9	48.5	75	45	10
8	17	-	48.5	75	48	10
10	17	-	48.5	75	65	10
12	19	-	48.5	75	90	10

RS3010MZ/8-L50 RS3010MZ/8-L75

 Socket Set on magnetic Rail
Steckschlüsselsatz auf Magnetschiene
Jeu de douilles sur rail à aimant



RS3010MZ/8-L50	8 Pieces Set/Rail 200mm	(g)
3, 4, 5, 6, 7, 8, 10, 12		460

RS3010MZ/8-L75	8 Pieces Set/Rail 200mm	(g)
3, 4, 5, 6, 7, 8, 10, 12		530

3025Z-50 / -75

 TORX® Bit Sockets
TORX® Bit-Steckschlüssel
Douilles tournevis, TORX®



3025Z-50 (T)	D (mm)	d (mm)	H (mm)	L (mm)	(g)	(pcs.)
T10	17	3	23.5	50	27	10
T15	17	3.5	23.5	50	28	10
T20	17	3.9	23.5	50	28	10
T25	17	4.5	23.5	50	29	10
T27	17	5	23.5	50	30	10
T30	17	5.6	23.5	50	31	10
T40	17	6.7	23.5	50	35	10
T45	17	7.83	23.5	50	38	10
T50	17	8.90	23.5	50	48	10
T55	19	11.3	23.5	50	70	10

3025Z-75 (T)	D (mm)	d (mm)	H (mm)	L (mm)	(g)	(pcs.)
T20	17	4.5	48.5	75	32	10
T25	17	5	48.5	75	33	10
T27	17	5	48.5	75	33	10
T30	17	5.6	48.5	75	35	10
T40	17	6.7	48.5	75	41	10
T45	17	7.9	48.5	75	45	10
T50	17	8.9	48.5	75	55	10
T55	19	11.3	48.5	75	80	10

RS3025Z/8-L50 RS3025Z/8-L75

 Socket Set on magnetic Rail
Steckschlüsselsatz auf Magnetschiene
Jeu de douilles sur rail à aimant



RS3025Z/8-L50	8 Pieces Set/Rail 200mm	(g)
T20, T25, T27, T30, T40, T45, T50, T55		450

RS3025Z/8-L75	8 Pieces Set/Rail 200mm	(g)
T20, T25, T27, T30, T40, T45, T50, T55		480

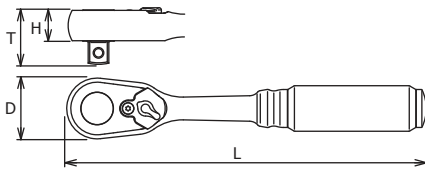

36

	D (mm)	T (mm)	H (mm)	L (mm)	(g)	(pce.)
2725Z-3/8	20.5	20.5	9.5	114	83	1
2725Z-3/8 (L160)	20.5	20.5	9.5	160	120	1

* Renewal Kits → 2725RK-3/8 → P308

⚠ 2725Z-3/8 (L160) have longer handle than standard, and can be loaded to excessive torque value. In the interest of your own safety always apply load evenly and progressively to avoid breakage and possible injury.

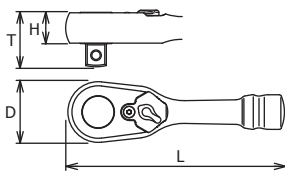

72

	D (mm)	T (mm)	H (mm)	L (mm)	(g)	(pce.)
3725ZS	28	24.5	13.7	100	157	1

* Renewal Kits → 3725RK → P308

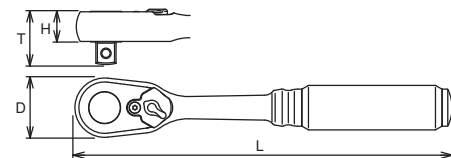

72

	D (mm)	T (mm)	H (mm)	L (mm)	(g)	(pce.)
3725Z	28	24.5	13.7	178	254	1
3725Z-280	28	24.5	13.7	280	360	1

* Renewal Kits → 3725RK → P308

⚠ 3725Z-280 have longer handle than standard, and can be loaded to excessive torque value. In the interest of your own safety always apply load evenly and progressively to avoid breakage and possible injury.

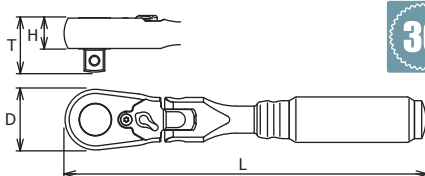

36 

	D (mm)	T (mm)	H (mm)	L (mm)	(g)	(pce.)
2726Z-3/8	20.5	20.5	9.5	114	107	1
2726Z-3/8 (L160)	20.5	20.5	9.5	160	130	1

* Renewal Kits → 2725RK-3/8 → P308

⚠ 2726Z-3/8 (L160) have longer handle than standard, and can be loaded to excessive torque value. In the interest of your own safety always apply load evenly and progressively to avoid breakage and possible injury.

2725Z-3/8 2725Z-3/8 (L160) ⚠

Reversible Ratchet Short
Knarre kurz, verstellbar
Cliquet court, réversible



3725ZS

Reversible Ratchet Short
Knarre kurz, verstellbar
Cliquet court, réversible



3725Z 3725Z-280 ⚠

Reversible Ratchet
Knarre, verstellbar
Cliquet, réversible



2726Z-3/8 2726Z-3/8 (L160) ⚠

Flexible Ratchet, Reversible (Short)
Gelenk-Knarre kurz, verstellbar
Cliquet articulé court, réversible



3726ZS

Flexible Ratchet, Reversible (Short)
Gelenk-Knarre kurz, verstellbar
Cliquet articulé court, réversible

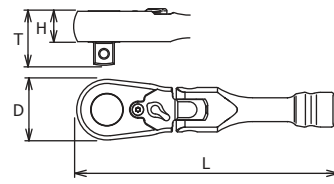

	D (mm)	T (mm)	H (mm)	L (mm)	(g)	(pcs.)
3726ZS	28	24.5	13.7	120	196	1

* Renewal Kits → 3725RK → P308

3726Z

3726Z-280

Flexible Ratchet, Reversible
Gelenk-Knarre, verstellbar
Cliquet articulé, réversible

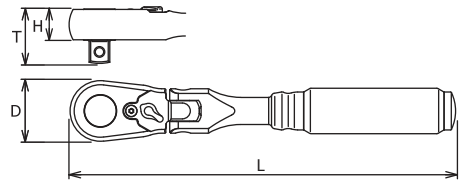

	D (mm)	T (mm)	H (mm)	L (mm)	(g)	(pcs.)
3726Z	28	24.5	13.7	178	317	1
3726Z-280	28	24.5	13.7	280	420	1

* Renewal Kits → 3725RK → P308

⚠ 3726Z-280 have longer handle than standard, and can be loaded to excessive torque value. In the interest of your own safety always apply load evenly and progressively to avoid breakage and possible injury.

3768Z-250

3768Z-400

Hinge Handle
Gelenkgriff
Poignée articulée

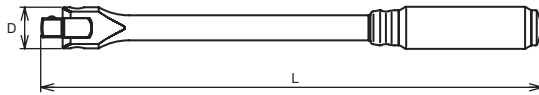

	D (mm)	L (mm)	(g)	(pcs.)
3768Z-250	20.5	250	309	5
3768Z-400	20.5	400	500	2

* Renewal Kits → 3768ZRK → P309

3760Z

Extension Bars
Verlängerungen
Rallonges

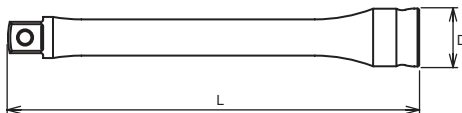

	D (mm)	L (mm)	(g)	(pcs.)
3760Z-75	17.5	75	66	10
3760Z-125	17.5	125	103	10
3760Z-250	17.5	250	195	5

⚠ 3768Z-400 have longer handle than standard, and can be loaded to excessive torque value. In the interest of your own safety always apply load evenly and progressively to avoid breakage and possible injury.

	D (mm)	L (mm)	(g)	(pcs.)
3771Z	18	42.5	44	10



3771Z Universal Joint
Gelenk-Einsatz
Joint articulé

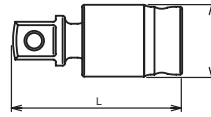
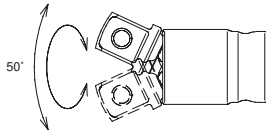

	D (mm)	L (mm)	(g)	(pcs.)
3772Z	17	65	76	10

3772Z Universal Double Joint
Doppelgelenk-Einsatz
Joint articulé double

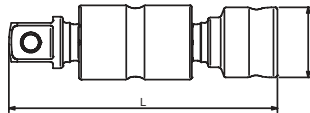
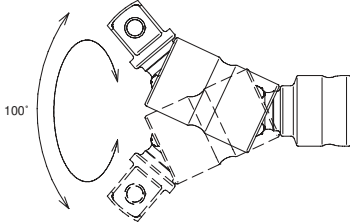

	D (mm)	L (mm)	(g)	(pcs.)
3756Z	28	25	40	10

Outside diameter is smaller compared to standard 3756.
Ideal for working in combination with 3725Z



3756Z Quick Spinner
Rändel-Drehscheibe
Lanceur

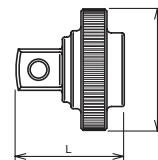

	D (mm)	L (mm)	(g)	(pcs.)
3756ZS	20.3	25	26	10

Ideal for working in combination with 2725Z-3/8 and 2726Z-3/8.

3756ZS Quick Spinner
Rändel-Drehscheibe
Lanceur

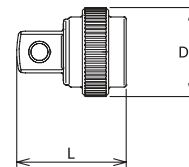

	D (mm)	L (mm)	(g)	(pcs.)
3756Z-1/2	28	29	52	10

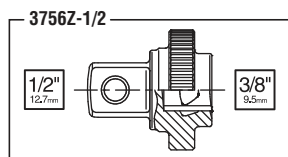

3756Z-1/2 Quick Spinner, Adaptor
Rändel-Drehscheibe als Adaptor
Lanceur, adaptateur

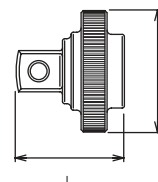

	D (mm)	L (mm)	(g)	(pcs.)
3322AZ-75	17.5	75	42	10

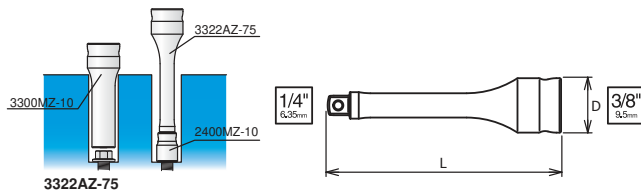

3322AZ-75 Extension Adaptor
Verlängerungsadapter
Reduction adaptateur-rallonge



Z-series
Z-serie
Series-Z

3/8"

Z-SERIES

HAND

TITANIUM

ACCESSORIES

SCREWDRIVERS

IMPACT

SLEEVE-DRIVE

PROTECTOR

INDUSTRIAL

AUTOMOTIVE

MOTORCYCLE

CONSTRUCTION

SPARE PART

3285Z Set in PE-foam tray
Steckschlüsselsatz in Weichschaumeinlage
Set disposé dans boîte de rangement en mousse souple



3285ZA Set in PE-foam tray
Steckschlüsselsatz in Weichschaumeinlage
Set disposé dans boîte de rangement en mousse souple



3286Z Set in PE-foam tray
Steckschlüsselsatz in Weichschaumeinlage
Set disposé dans boîte de rangement en mousse souple



3285ZE Socket Sets
Steckschlüssel Sätze
Jeu de clés à douilles













RSAL200  Magnetic Rail with retaining clips
Magnetschiene mit Halteklammern
RSAL300 Rail à aimant avec clips de maintien







RSAL Magnetic Rails and retaining Clips, bulk
Magnetschiene und Halteklammern, lose
CLIP.P/5 Rail à aimant avec clips de maintien, en vrac









3285Z 26 Pieces Set/△=2,100g
PLASTIC TRAY:W390xT180xH25

Sockets	Accessories
 3400MZ 6-pt. Sockets 5.5, 6, 7, 8, 10, 12, 13, 14, 17, 19, 21, 22	 3725Z
 3300MZ 6-pt. Deep Sockets 8, 10, 12, 14	 3756Z
 3300CZ Spark Plug Sockets 14, 16, 20.8	 3771Z
	 3768Z-250
	 3760Z-75
	 3760Z-125
	 3760Z-250



3285ZA 15 Pieces Set/△=750g
PLASTIC TRAY:W300xT90xH25

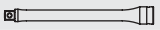

Sockets	Accessories
 3400MZ 6-pt. Sockets 5.5, 6, 7, 8, 10, 12, 13, 14, 17, 19, 21, 22	 3725Z
	 3756Z
	 3771Z



3286Z 21 Pieces Set/△=2,600g
BLACK METAL CASE:W415xH120xT50mm

Sockets	Accessories
 3400MZ 6-pt. Sockets 7, 8, 10, 11, 12, 13, 14, 15, 16, 17, 18, 19, 21, 22	 3725Z
	 3756Z
	 3771Z
	 3768Z-250
	 3760Z-75
	 3760Z-125
	 3760Z-250

3285ZE 9 Pieces Set/△=600g
Rail 200mm/PLASTIC BAG





Sockets	Accessories
 3400MZ 6-pt. Sockets 8, 10, 12, 13, 14, 17, 19	 3725Z
	 3756Z

RSAL200		RAIL (mm)	CLIP (pcs.)	(g)	(pce.)
1/4x12		200	12	125	1
3/8x8		200	8	130	1

RSAL300		RAIL (mm)	CLIP (pcs.)	(g)	(pce.)
3/8x12		300	12	180	1
1/2x10		300	10	190	1



RAIL	RAIL (mm)	(g)	(pce.)
RSAL200	200	110	1
RSAL300	300	145	1
RSAL400	400	210	1

CLIP.P/5		(g)	(pcs.)
1/4		10	5
3/8		13	5
1/2		20	5

4400MZ (mm)	D ₁ (mm)	D ₂ (mm)	H (mm)	L (mm)	(g)	(pcs.)
8	12.6	20.6	4.5	26	30	10
10	15	20.6	4.5	26	31	10
12	17	20.6	5.5	27	32	10
13	18.3	21.5	6.5	28	40	10
14	19.5	21.5	6.5	28	40	10
16	22	21.5	7.5	29	43	10
17	23	22.5	7.5	29	49	10
18	24.1	23.7	7.5	29	56	10
19	25.3	24.4	9.5	29	62	10
21	27.6	26.3	10.5	29	76	10
22	28.8	27.5	11	29	83	10
24	31.1	29.2	12	29	96	5
27	34.6	32.2	13.5	30	124	5
30	38.1	35.2	14.5	31	156	5
32	40.4	36.8	15.5	32	178	5

RS4400MZ/10	10 Pieces Set/Rail 300mm	(g)
10, 12, 13, 14, 17, 19, 21, 22, 24, 27		830

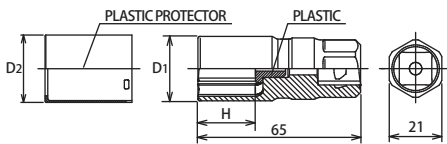

4300PMZ-65 (mm)	D ₁ (mm)	D ₂ (mm)	H (mm)	Shaft Colour	(g)	(pcs.)
New 17	23.7	25.2	21	Blue	135	10
New 19	25.7	27.2	23	Red	150	10
New 21	27.5	29	25	Yellow	155	10

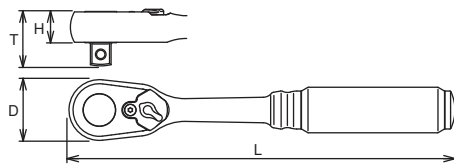

4725Z	D (mm)	T (mm)	H (mm)	L (mm)	(g)	(pce.)
4725Z	36.5	32.8	18.2	253	590	1

* Renewal Kits → 4725RK → P308



4400MZ

6-point Sockets
6-kant Steckschlüssel
Douilles 6-pans

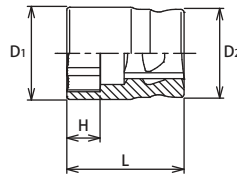

RS4400MZ/10

Socket Set on magnetic Rail
Steckschlüsselsatz auf Magnetschiene
Jeu de douilles sur rail à aimant



4300PMZ-65

Wheel Nut Sockets
Radmutter Steckschlüssel
Douilles pour écrous de roue



⚠ Please note that thin walled design is only for wheel nut work and Torque rating is limited.

4725Z

Reversible Ratchet
Knarre, verstellbar
Cliquet, réversible



4768Z-430

Hinge Handle
Gelenkgriff
Poignée articulée

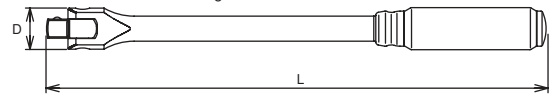

⚠ 4768Z-430 have longer handle than standard, and can be loaded to excessive torque value. In the interest of your own safety always apply load evenly and progressively to avoid breakage and possible injury.

4768Z-430	D (mm)	L (mm)	(g)	(pce.)
4768Z-430	28	430	720	2

* Renewal Kits → 4768ZRK → P309

4711XZ

Spinning Cross Wrench
T-Griff für die Radmuttermontage
Poignée coulissante pour montage des écrous à roue

4711XZ	L1 (mm)	L2 (mm)	L3 (mm)	(g)	(pce.)
4711XZ	133	264	350	915	1

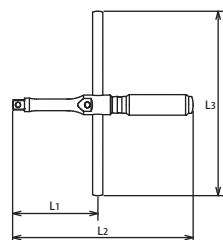

4760Z

Extension Bars
Verlängerungen
Rallonges

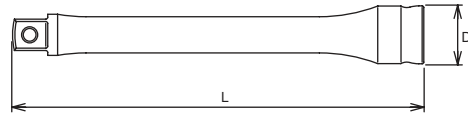

	D (mm)	L (mm)	(g)	(pcs.)
4760Z-125	22.5	125	180	5
4760Z-250	22.5	250	340	5

4771Z

Universal Joint
Gelenk-Einsatz
Joint articulé

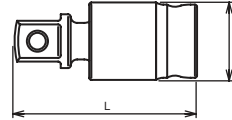

	D (mm)	L (mm)	(g)	(pcs.)
4771Z	23.7	55.8	100	10

4772Z

Universal Double Joint
Doppelgelenk-Einsatz
Joint articulé double

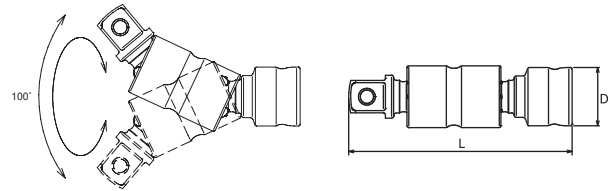

	D (mm)	L (mm)	(g)	(pcs.)
4772Z	23.7	87.2	170	5

4756Z

Quick Spinner
Rändel-Drehscheibe
Lanceur

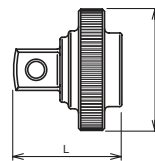

	D (mm)	L (mm)	(g)	(pcs.)
4756Z	36.3	33.5	84	10

4285Z

Set in Foam tray
Steckschlüsselsatz in Weichschaumeinlage
Set disposé dans boîte de rangement en mousse souple



4285Z 21 Pieces Set/△=4,800g

METAL CASE:W445×T190×H50

Sockets	Accessories
4400MZ 6-pt. Sockets 8, 10, 12, 13, 14, 16, 17, 18, 19, 21, 22, 24, 27, 30, 32	4725Z 4756Z 4771Z 4768Z-430 4760Z-125 4760Z-250

4285ZE

Socket Sets
Steckschlüssel Sätze
Jeu de clés à douilles



4285ZE 11 Pieces Set/△=1,380g

Rail 300mm/PLASTIC BAG

Sockets	Accessories
4400MZ 6-pt. Sockets 10, 12, 13, 14, 17, 19, 21, 22, 24	4725Z 4756Z

HAND

SOCKETS
STECKSCHLÜSSEL
DOUILLES À MAIN

1/4"

3/8"

1/2"

3/4"

1"







Hand Sockets
Hand Steckschlüssel
Douilles à main

Hand Sockets	1/4"(6.35mm)SQ.				3/8"(9.5mm)SQ.				1/2"(12.7mm)SQ.				3/4"(19mm)SQ.		1"(25.4mm)SQ.				
	No.	mm	Page	No.	mm	Page	No.	mm	Page	No.	mm	Page	No.	mm	Page	No.	mm	Page	
Standard Sockets	6-point	2400M 2400A 2400W	40 40 41	3400M 3400A 3400W	58 58 59	4401M / 4400M 4400A 4400W	92 93 94	6400M 6400A 6400W	mm inch inch	120 120 120	8400M 8400A	mm inch	126 126						
	12-point	2405M AS2405A	40 40	3405M 3405A 3405W	58 58 59	4406M / 4405M 4405A 4405W	92 93 94	6405M 6405A	mm inch	120 120	8405M 8405A	mm inch	126 126						
Semi Deep Sockets	Surface	2410M	41	3410M	59	4410M	94												
	NUT GRIP®	2450MS	42	3450M 3450MH	61 61	4450M	96												
Deep Sockets	TORX® (E)	2425	42	3425	60	4425	95	6425	TORX®	120									
	TORX®(E) (NUT GRIP®) TORXplus® (EP)			3425(2B)	61	4425-EPL TORXplus®	95												
Extra Deep Sockets	LH-S			3400LH	60	4400LH	96												
	Double Square	2415M 2415A	41 41	3415M 3415A	60 60														
Universal Sockets	6-point	2300X	42	3300X 3305X	62 62														
	12-point	2300X	42	3300XA 3305XA	62 62														
Extension Sockets	NUT GRIP®	2350X	42	3350X	62														
	6-point	2300M 2300A 2300W	43 43 44	3300M 3300A 3300W	63 63 64	4300M 4300A	97 97	6300M 6300A	mm inch	121 121									
Universal Bit Sockets	12-point	2305M AS2305A	43 43	3305M 3305W	63 64	4305M 4305A	97 97	6305M 6305A	mm inch	121 121									
	Surface	2310M	44	3310M	64	4310M	98												
Universal Bit Sockets	NUT GRIP®	2350M	44	3350M	65														
	TORX® (E)	2325	44	3325	65	4325	98												
Universal Bit Sockets	Fare Nut			3300FN	65														
	6-point			3300M(L120)	66	4300M(L120)	99												
Universal Sockets	12-point			3305M(L120)	66														
	NUT GRIP®			3350M(L120)	66														
Universal Sockets	TORX® (E)					4325(L140)	99												
	TORX®(E) (NUT GRIP®)			4325(L140) TORX®	99														
Universal Bit Sockets	12-point																		
	6-point	2440M 2440A	45 45	3440M 3440A	67 67	4440M 4440A	100 100												
Universal Sockets	12-point	2445M 2445A AS2445A	45 45 45	3445M 3445A 3445W	67 67 67	4445M 4445A	100 100												
	NUT GRIP®	2441M	45	3441M	68														
Universal Bit Sockets	TORX® (E)	2440T	45	3440T	68	4440T	100												
	6-point			3340M	68														
Universal Bit Sockets	PH	2000	46	3000	70	4000	100												
	PZ	2000(PZ)	46	3000(PZ)	70	4000(PZ)	100												
Universal Bit Sockets	Slotted	2005	46	3005	70	4005	100												
	Hexagon	2010M 2010A	47 47	3010M 3010A 3012M	71 71 72	4010M 4010A 4012M 4012A	101 101 102 103	6012M	mm	121	8012M	mm	127						
Universal Bit Sockets	Hexagon (Grip Ring)	2011M	47	3011M	73														
	Hexagon (Ball Point)	2020	47	3020	74	4020	104												
Universal Bit Sockets	XZN (Triple Square)	2020	47	3020	74	4020	104												
	TORX® (T)	2025(T)	48	3025(T)	75	4025(T)	105												
Universal Bit Sockets	TORX® (TH)	2025(TH)	48	3025(TH)	76														
	TORXplus® (P)	2025(P)	49	3025(P)	77	4025(P)	106												
Universal Bit Sockets	TORXplus® (PR)	2025(PR)	49	3025(PR)	78														
	Ribe CV			3027	78	4027	106												
Universal Bit Sockets	Hexagon	2430M	46	3430M	69														
	TORX® (T)	2430T	46																

Hand Sockets

Hand Steckschlüssel

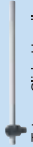
Douilles à main

Handles/Accessories	Square Drive					
	1/4" (6.35mm)SQ.	3/8" (9.5mm)SQ.	1/2" (12.7mm)SQ.	3/4" (19mm)SQ.	1" (25.4mm)SQ.	
	No.	No.	No.	No.	No.	Page
 <p>Ratchet Handles</p>	Standard	2753 series 3753 series 3752 series	81-82 81	4753 series 4750 series 4752 series	110 109 108	122
	Short	2753FS	80			128
	Long	2753P-160	50	4749-380 series 4753P-410	111 111	122
	Compact			3749S-1/2 series	108	
	Others			3753SM series 3757	80 85	
 <p>Flexible Ratchet Handles</p>	Standard	2774 series	83-84	4774 series	111-112	
	Short	2774PS 2774JS	51 51			
	Long			4774P-450	111	
	Compact			2774-3/8 series	82	
	Swivel Head			3776 series	84	
 <p>Hinge Handles</p>	Standard	2768 series	53	4768-380 series	112	123
	Long			4768-450 series	112	123
	Extra Long			4768-600 series	112	123
	Standard	2785	54	4785	114	124
	Long					128
 <p>T-type Slide Handles</p>	Standard	2769N	53	3769N	87	
	Wobble-Fix	2769NWF	53	3769NWF	87	
	Others	2769H	53	3769H	87	
	Standard	2780	54	4788 4747	115 115	124
	Flexible			4780-400	114	
 <p>L-handles</p>	Standard	2760	52	4760	113	123
	Flexible			4781N-450	114	
	Standard	2763	52	4763	113	
	Wobble-Fix	2763	52	4763	113	
	Flexible	2762	52	3762	85	
 <p>Speed Handles</p>	Standard	2770 2771	54 54	4770 4771	114 114	127
	Universal Joints			4433A 4466A	115 115	124 124
	Adaptors	2233A	54	3322A 3344A	88 88	127
	Ratchet Adaptors	2755	51	3755	85	123
	Quick Spinners	2756	51	3756	85	112

Hand Sockets
Hand Steckschlüssel
Douilles à main

1/4"

Z-SERIES

HAND

TITANIUM

SCREWDRIVERS ACCESSORIES

IMPACT

SLEEVE-DRIVE

PROTECTOR

INDUSTRIAL

AUTOMOTIVE

MOTORCYCLE

CONSTRUCTION

SPARE PART

2400M / 2400A

6-point Sockets
6-kant Steckschlüssel
Douilles 6-pans

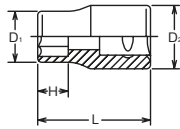

2400M 2405M (mm)	D ₁ (mm)	D ₂ (mm)	H (mm)	L (mm)	(g)	(pcs.)
3	5.5	11.2	2.6	22	7	10
3.5	6.1	11.2	3	22	7	10
4	6.7	11.2	3.5	22	8	10
4.5	7.3	11.2	4	22	8	10
5	8	11.2	5	22	8	10
5.5	8.5	11.2	5.5	22	9	10
6	9.2	11.2	5.5	22	9	10
7	10.3	11.2	6	22	9	10
8	11.2	11.7	6.9	22	11	10
9	13	12	7.3	22	12	10
10	14.3	12.9	7.7	22	15	10
11	15.5	14.3	9.3	22	18	10
12	16.8	15.5	9.3	22	23	10
13	18	16.4	9.8	22	23	10
14	19.3	17.9	11	24	30	10

2405M / 2405A

12-point Sockets
12-kant Steckschlüssel
Douilles 12-pans

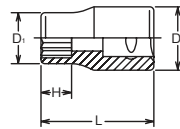

2400A 2405A (inch)	D ₁ (mm)	D ₂ (mm)	H (mm)	L (mm)	(g)	(pcs.)
1/8	5.7	11.2	2.7	22	7	10
5/32	6.7	11.2	3.5	22	8	10
3/16	7.8	11.2	5	22	8	10
7/32	8.5	11.2	5.5	22	9	10
1/4	9.6	11.2	5.8	22	9	10
9/32	10.3	11.2	6	22	9	10
5/16	11.2	11.7	6.9	22	11	10
11/32	12.5	11.7	7.3	22	12	10
3/8	13.7	12.5	7.7	22	15	10
7/16	15.5	14.3	9.3	22	18	10
1/2	18	16.4	9.8	22	23	10
9/16	19.3	17.9	11	24	30	10

RS2400M/12 RS2405M/12

Socket Set on Rail
Steckschlüsselsatz auf Schiene
Jeu de douilles sur rail



RS2400M/12	12 Pieces Set/Rail 200mm	(g)
4, 5, 5.5, 6, 7, 8, 9, 10, 11, 12, 13, 14		200

RS2405M/12	12 Pieces Set/Rail 200mm	(g)
4, 5, 5.5, 6, 7, 8, 9, 10, 11, 12, 13, 14		200

RS2400A/9 RS2405A/9

Socket Set on Rail
Steckschlüsselsatz auf Schiene
Jeu de douilles sur rail



RS2400A/9	9 Pieces Set/Rail 150mm	(g)
3/16, 7/32, 1/4, 9/32, 5/16, 11/32, 3/8, 7/16, 1/2		162

RS2405A/9	9 Pieces Set/Rail 150mm	(g)
3/16, 7/32, 1/4, 9/32, 5/16, 11/32, 3/8, 7/16, 1/2		162

AS2405A

12-point Sockets, AS954
12-kant Steckschlüssel, AS954
Douilles 12-pans, AS954

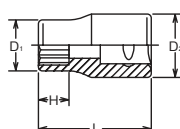

AS2405A (inch)	D ₁ (mm)	D ₂ (mm)	H (mm)	L (mm)	(g)	(pcs.)
3/16	7.7	10.9	5.1	22	8	10
7/32	8.5	10.9	5.5	22	8	10
1/4	9.4	10.9	5.9	22	8	10
9/32	10.2	10.9	6.1	22	8	10
5/16	11.3	11.7	7.3	22	10	10
11/32	12.5	12	7.5	22	10	10
3/8	13.7	12.9	8.2	22	13	10
7/16	15.6	14.3	9.4	22	17	10
1/2	17.2	16.4	10.3	22	20	10
9/16	18.8	17.9	11	24	27	10

Aerospace Standard SAE AS954

RSAS2405A/10

Socket Set on Rail
Steckschlüsselsatz auf Schiene
Jeu de douilles sur rail



RSAS2405A/10	10 Pieces Set/Rail 150mm	(g)
3/16, 7/32, 1/4, 9/32, 5/16, 11/32, 3/8, 7/16, 1/2, 9/16		160

1/4" Hand Sockets Hand Steckschlüssel Douilles à main

Z-SERIES
HAND
TITANIUM
ACCESSORIES
SCREWDRIVERS
IMPACT
SLEEVE-DRIVE
PROTECTOR
INDUSTRIAL
AUTOMOTIVE
MOTORCYCLE
CONSTRUCTION
SPARE PART

2410M (mm)	D ₁ (mm)	D ₂ (mm)	H (mm)	L (mm)	(g)	(pcs.)
4	6.7	11.2	3.5	22	8	10
4.5	7.3	11.2	4	22	8	10
5	8	11.2	5	22	8	10
5.5	8.5	11.2	5.5	22	9	10
6	9.2	11.2	5.5	22	9	10
7	10.3	11.2	6	22	9	10
8	11.2	11.7	6.9	22	11	10
9	13	12	7.3	22	12	10
10	14.3	12.9	7.7	22	15	10
11	15.5	14.3	9.3	22	18	10
12	16.8	15.5	9.3	22	23	10
13	18	16.4	9.8	22	23	10
14	19.3	17.9	11	24	30	10



2410M Surface Drive Sockets
Surface Drive Steckschlüssel
Douilles, Surface Drive

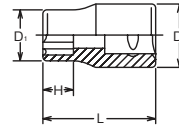

RS2410M/12	12 Pieces Set/Rail 200mm	(g)
4, 5, 5.5, 6, 7, 8, 9, 10, 11, 12, 13, 14		222

RS2410M/12 Socket Set on Rail
Steckschlüsselsatz auf Schiene
Jeu de douilles sur rail



2400W (BA)	D ₁ (mm)	D ₂ (mm)	H (mm)	L (mm)	(g)	(pcs.)
8	6.1	11.2	3	22	7	10
7	7.3	11.2	4	22	8	10
6	8	11.2	5	22	8	10
5	8.5	11.2	5.5	22	9	10
4	9.6	11.2	5.8	22	9	10
3	10.3	11.2	6	22	9	10
2	11.2	11.7	6.9	22	11	10
1	13	12	7.3	22	12	10
0	14.9	13.6	8	22	16	10

2400W-BA 6-point Sockets
6-kant Steckschlüssel
Douilles 6-pans

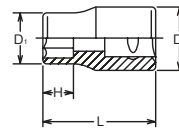

RS2400W/9-BA	9 Pieces Set/Rail 150mm	(g)
8, 7, 6, 5, 4, 3, 2, 1, 0		120

RS2400W/9-BA Socket Set on Rail
Steckschlüsselsatz auf Schiene
Jeu de douilles sur rail



BA



BA	8BA	7BA	6BA	5BA	4BA	3BA	2BA	1BA	0BA
S (ref. mm)	3.86	4.37	4.90	5.59	6.30	7.16	8.23	9.27	10.49
S (ref. inch)	0.152	0.172	0.193	0.220	0.248	0.282	0.324	0.365	0.413

2415M (mm)	D ₁ (mm)	D ₂ (mm)	H (mm)	L (mm)	(g)	(pcs.)
5.5	10.3	11.2	5.4	22	10	10
6	11	11.7	5.4	22	13	10
7	12.5	11.7	6.1	22	13	10
8	14.3	12.9	6.8	22	17	10
10	17.4	16	8.2	22	27	10

2415M / 2415A Double 4-point Sockets
Doppelvierkant Steckschlüssel
Douilles mâles 4-pans doubles

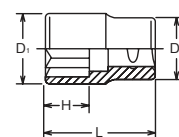

2415A (inch)	D ₁ (mm)	D ₂ (mm)	H (mm)	L (mm)	(g)	(pcs.)
1/4	11	11.7	5.4	22	14	10
5/16	14.3	12.9	6.8	22	17	10
11/32	15.9	14.3	7.5	22	21	10
3/8	17.4	16	8.2	22	26	10

TORX is a registered trademark of CAMCAR Innovations.
TORX ist ein registriertes Markenzeichen der Firma CAMCAR Innovations.
TORX est une marque déposée de CAMCAR Innovations.

Hand Sockets Hand Steckschlüssel Douilles à main

1/4"

Z-SERIES

HAND

TITANIUM

ACCESSORIES

SCREWDRIVERS

IMPACT

SLEEVE-DRIVE

PROTECTOR

INDUSTRIAL

AUTOMOTIVE

MOTORCYCLE

CONSTRUCTION

SPARE PART

2425 TORX® Sockets TORX® Steckschlüssel Douilles TORX®

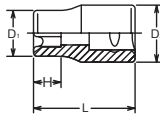

2425 (E)	D ₁ (mm)	D ₂ (mm)	H (mm)	L (mm)	(g)	(pcs.)
E 4	5.4	11.2	4.6	22	7	10
E 5	6.7	11.2	5.2	22	8	10
E 6	7.7	11.2	5.4	22	8	10
E 7	8.3	11.2	6.6	22	9	10
E 8	9.6	11.2	7	22	9	10
E10	11.3	12	8.2	22	10	10
E11	12.9	12	8.7	22	13	10
E12	14.3	12.9	9.3	23	17	10

RS2425/6 Socket Set on Rail Steckschlüsselsatz auf Schiene Jeu de douilles sur rail



RS2425/6	6 Pieces Set/Rail 150mm	(g)
E4, E5, E6, E7, E8, E10		85

TORX® (E)

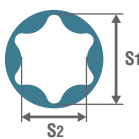

E	E4	E5	E6	E7	E8	E10	E11	E12	E14	E16	E18	E20	E22	E24	E26	E28	E30	E32
S ₁ (ref. mm)	3.7	4.6	5.6	6.1	7.4	9.3	9.9	11.0	12.8	14.6	16.5	18.3	20.1	22.0	23.7	25.5	27.3	29.0
S ₂ (ref. mm)	2.7	3.3	4.0	4.3	5.3	6.8	7.1	7.9	9.2	10.5	11.9	13.2	14.8	15.7	17.5	18.3	20.0	21.3

2450MS Nut Grip Sockets Nut Grip® Steckschlüssel mit 2-facher Kugelhalterung Douilles à billes de retenue

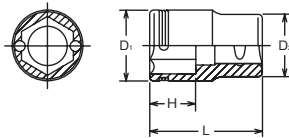

2450MS (mm)	D ₁ (mm)	D ₂ (mm)	H (mm)	L (mm)	(g)	(pcs.)
7	11.3	11.2	4	18	8	10
8	12.3	11.2	5	18	9	10
10	14.3	12.9	6	19	13	10
12	17.4	16	7	20	22	10
13	18	16.4	8	20	22	10
14	19.9	18	8.5	22	31	10

RS2450MS/6 Socket Set on Rail Steckschlüsselsatz auf Schiene Jeu de douilles sur rail



RS2450MS/6	6 Pieces Set/Rail 150mm	(g)
7, 8, 10, 12, 13, 14		120

2300X 6-point Sockets, Semi-Deep 6-kant Steckschlüssel, mittel-lang Douilles, semi-profondes 6-pans

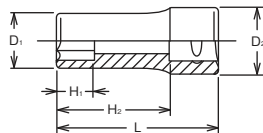

2300X (mm)	D ₁ (mm)	D ₂ (mm)	H ₁ (mm)	H ₂ (mm)	L (mm)	(g)	(pcs.)
4	6.7	11.2	4	22	32	10	10
5	8	11.2	5.5	22	32	11	10
5.5	8.5	11.2	6	22	32	12	10
6	9.2	11.2	7	22	32	12	10
7	10.5	11.2	8	22	32	13	10
8	11.8	11.2	9	22	32	16	10
9	13	12	10	22	32	18	10
10	14.3	12.9	11	21	32	23	10
11	15.5	14.3	12	21	32	27	10
12	16.8	15.5	13	21	32	29	10
13	18	16.4	14	21	32	32	10
14	19.3	17.9	16	20	32	37	10

RS2300X/12 Socket Set on Rail Steckschlüsselsatz auf Schiene Jeu de douilles sur rail



RS2300X/12	12 Pieces Set/Rail 200mm	(g)
4, 5, 5.5, 6, 7, 8, 9, 10, 11, 12, 13, 14		270

2350X Nut Grip Socket, Semi-Deep Nut Grip® Steckschlüssel mit 2-facher Kugelhalterung, mittel-lang Douilles à billes de retenue, semi-profondes

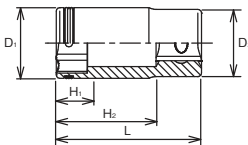

2350X (mm)	D ₁ (mm)	D ₂ (mm)	H ₁ (mm)	H ₂ (mm)	L (mm)	(g)	(pcs.)
8	12.3	11.7	5	21.5	32	17	10
10	14.3	12.9	6	21.5	32	22	10
12	16.8	16	7	21.5	32	34	10
14	20	18	8.5	21.5	32	43	10

RS2350X/4 Socket Set on Rail Steckschlüsselsatz auf Schiene Jeu de douilles sur rail



RS2350X/4	4 Pieces Set/Rail 150mm	(g)
8, 10, 12, 14		140

2300M 2305M (mm)	D ₁ (mm)	D ₂ (mm)	H ₁ (mm)	H ₂ (mm)	L (mm)	(g)	(pcs.)
3	5.5	11.2	3	40	50	15	10
4	6.7	11.2	4	40	50	15	10
4.5	7.3	11.2	4.5	40	50	15	10
5	8	11.2	5.5	40	50	17	10
5.5	8.5	11.2	6	40	50	17	10
6	9.2	11.2	7	40	50	20	10
7	10.5	11.2	8	40	50	25	10
8	11.8	11.2	9	40	50	25	10
9	13	12	10	40	50	30	10
10	14.3	12.9	11	39	50	34	10
11	15.5	14.3	12	39	50	43	10
12	16.8	15.5	13	39	50	50	10
13	18	16.4	14	39	50	52	10
14	19.3	17.9	16	38	50	57	10



2300M / 2300A

6-point Deep Sockets
6-kant-Steckschlüssel, lang
Douilles longues 6-pans

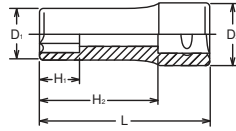

2300A 2305A (inch)	D ₁ (mm)	D ₂ (mm)	H ₁ (mm)	H ₂ (mm)	L (mm)	(g)	(pcs.)
1/8	5.7	11.2	3.5	40	50	15	10
5/32	6.7	11.2	4	40	50	15	10
3/16	7.8	11.2	5.5	40	50	17	10
7/32	8.5	11.2	6	40	50	17	10
1/4	9.8	11.2	7	40	50	25	10
9/32	10.5	11.2	8	40	50	25	10
5/16	11.8	11.2	9	40	50	25	10
11/32	12.5	11.7	10	40	50	30	10
3/8	13.7	12.5	11	40	50	34	10
7/16	15.5	14.3	12	39	50	43	10
1/2	18	16.4	14	39	50	52	10
9/16	19.3	17.9	16	38	50	57	10

2305M / 2305A

12-point Deep Sockets
12-kant-Steckschlüssel, lang
Douilles longues, 12-pans

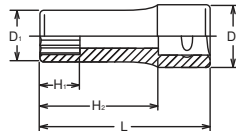

RS2300M/12	12 Pieces Set/Rail 200mm	(g)
4, 5, 5.5, 6, 7, 8, 9, 10, 11, 12, 13, 14		400

RS2305M/12	12 Pieces Set/Rail 200mm	(g)
4, 5, 5.5, 6, 7, 8, 9, 10, 11, 12, 13, 14		400

RS2300M/12



Socket Set on Rail
Steckschlüsselsatz auf Schiene
Jeu de douilles sur rail

RS2305M/12



RS2300A/9	9 Pieces Set/Rail 150mm	(g)
3/16, 7/32, 1/4, 9/32, 5/16, 11/32, 3/8, 7/16, 1/2		296

RS2305A/9	9 Pieces Set/Rail 150mm	(g)
3/16, 7/32, 1/4, 9/32, 5/16, 11/32, 3/8, 7/16, 1/2		296

RS2300A/9



Socket Set on Rail
Steckschlüsselsatz auf Schiene
Jeu de douilles sur rail

RS2305A/9



AS2305A (inch)	D ₁ (mm)	D ₂ (mm)	H ₁ (mm)	H ₂ (mm)	L (mm)	(g)	(pcs.)
3/16	7.7	10.9	6	40	50	17	10
7/32	8.5	10.9	6.5	40	50	17	10
1/4	9.4	10.9	7	40	50	19	10
9/32	10.2	10.9	8	40	50	18	10
5/16	11.3	11.7	9	40	50	23	10
11/32	12.5	12	10	40	50	24	10
3/8	13.7	12.8	11	39	50	31	10
7/16	15.6	14.2	12	39	50	38	10
1/2	17.2	16.2	14	39	50	42	10
9/16	18.8	17.1	16	38	50	47	10

Aerospace Standard SAE AS954

AS2305A

12-point Deep Sockets, AS954
12-kant Steckschlüssel, lang, AS954
Douilles longues 12-pans, AS954

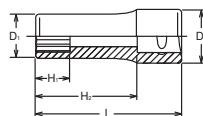

RSAS2305A/10	10 Pieces set/Rail 150mm	(g)
3/16, 7/32, 1/4, 9/32, 5/16, 11/32, 3/8, 7/16, 1/2, 9/16		307

RSAS2305A/10



Socket Set on Rail
Steckschlüsselsatz auf Schiene
Jeu de douilles sur rail



Hand Sockets Hand Steckschlüssel 1/4" Douilles à main

Z-SERIES

HAND

TITANIUM

ACCESSORIES

SCREWDRIVERS

IMPACT

SLEEVE-DRIVE

PROTECTOR

INDUSTRIAL

AUTOMOTIVE

MOTORCYCLE

CONSTRUCTION

SPARE PART

2310M Surface Drive Deep Sockets Surface Drive Steckschlüssel, lang Douilles longues, Surface Drive



SURFACE DRIVE

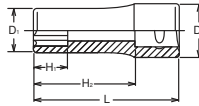

2310M (mm)	D ₁ (mm)	D ₂ (mm)	H ₁ (mm)	H ₂ (mm)	L (mm)	(g)	(pcs.)
3	5.5	11.2	3	40	50	15	10
4	6.7	11.2	4	40	50	15	10
4.5	7.3	11.2	4.5	40	50	15	10
5	8	11.2	5.5	40	50	17	10
5.5	8.5	11.2	6	40	50	17	10
6	9.2	11.2	7	40	50	20	10
7	10.5	11.2	8	40	50	25	10
8	11.8	11.2	9	40	50	25	10
9	13	12	10	40	50	30	10
10	14.3	12.9	11	39	50	34	10
11	15.5	14.3	12	39	50	43	10
12	16.8	15.5	13	39	50	50	10
13	18	16.4	14	39	50	52	10
14	19.3	17.9	16	38	50	57	10

RS2310M/12 Socket Set on Rail Steckschlüsselsatz auf Schiene Jeu de douilles sur rail



RS2310M/12	12 Pieces set/Rail 200mm	(g)
4, 5, 5.5, 6, 7, 8, 9, 10, 11, 12, 13, 14		400

2300W-BA 6-point Deep Sockets 6-kant-Steckschlüssel, lang Douilles longues 6-pans

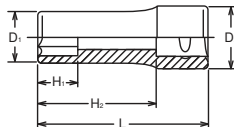

2300W (BA)	D ₁ (mm)	D ₂ (mm)	H ₁ (mm)	H ₂ (mm)	L (mm)	(g)	(pcs.)
4	9.8	11.2	7	40	50	22	10
3	10.5	11.2	8	40	50	25	10
2	11.8	11.2	9	40	50	25	10
1	13	12	10	40	50	30	10
0	14.9	13.6	12	39	50	38	10

BA



BA	8BA	7BA	6BA	5BA	4BA	3BA	2BA	1BA	0BA
S (ref. mm)	3.86	4.37	4.90	5.59	6.30	7.16	8.23	9.27	10.49
S (ref. inch)	0.152	0.172	0.193	0.220	0.248	0.282	0.324	0.365	0.413

2325 TORX® Deep Sockets TORX® Steckschlüssel, lang Douilles longues TORX®

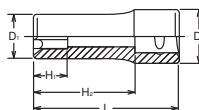

2325 (E)	D ₁ (mm)	D ₂ (mm)	H ₁ (mm)	H ₂ (mm)	L (mm)	(g)	(pcs.)
E 4	5.4	12	4.6	40	50	17	10
E 5	6.8	12	5.2	40	50	20	10
E 6	8	12	5.4	40	50	20	10
E 7	8.3	12	6.6	40	50	22	10
E 8	9.8	12	7	40	50	25	10
E10	11.6	12	8.2	40	50	29	10

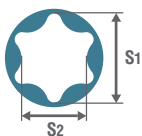
TORX®
(E)

E	E4	E5	E6	E7	E8	E10	E11	E12	E14	E16	E18	E20	E22	E24	E26	E28	E30	E32
S ₁ (ref. mm)	3.7	4.6	5.6	6.1	7.4	9.3	9.9	11.0	12.8	14.6	16.5	18.3	20.1	22.0	23.7	25.5	27.3	29.0
S ₂ (ref. mm)	2.7	3.3	4.0	4.3	5.3	6.8	7.1	7.9	9.2	10.5	11.9	13.2	14.8	15.7	17.5	18.3	20.0	21.3

2350M Nut Grip Deep Sockets **Nut Grip®** Steckschlüssel mit 2-facher Kugelhalterung, lang Douilles longues à billes de retenue



NUT GRIP®

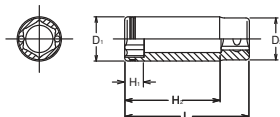

2350M (mm)	D ₁ (mm)	D ₂ (mm)	H ₁ (mm)	H ₂ (mm)	L (mm)	(g)	(pcs.)
8	12.3	11.7	5	39.5	50	30	10
10	14.3	12.9	6	39.5	50	35	10
12	16.8	16	7	39.5	50	55	10
14	20	18	8.5	39.5	50	70	10

RS2350M/4 Socket Set on Rail Steckschlüsselsatz auf Schiene Jeu de douilles sur rail



RS2350M/4	4 Pieces Set/Rail 150mm	(g)
8, 10, 12, 14		220

1/4"

Hand Sockets
Hand Steckschlüssel
Douilles à main

2440M 2445M (mm)	D ₁ (mm)	D ₂ (mm)	H (mm)	L (mm)	(g)	(pcs.)
4	6.7	13	4.8	31.5	17	10
5	8	13	5.3	32	17	10
6	9.2	13	6.1	33	18	10
7	10.5	13	6.5	33	19	10
8	11.7	13	7	34	19	10
9	13	13	7	34	20	10
10	14.2	13	8.3	35	20	10
11	15.5	13	9.5	36	21	10
12	16.7	13	10	37	21	10
13	18	13	10.5	37	26	10
14	19.2	13	10.5	37	28	10

2440A (inch)	D ₁ (mm)	D ₂ (mm)	H (mm)	L (mm)	(g)	(pcs.)
1/4	9.8	13	6.5	33	18	10
5/16	11.7	13	7	34	19	10
3/8	13.7	13	8.3	35	20	10
7/16	15.5	13	9.5	36	21	10
1/2	18	13	10.5	37	26	10
9/16	19.2	13	10.5	37	28	10

2445A (inch)	D ₁ (mm)	D ₂ (mm)	H (mm)	L (mm)	(g)	(pcs.)
3/16	8	13	5.3	32	18	10
1/4	9.8	13	6.5	33	18	10
9/32	10.5	13	6.5	33	19	10
5/16	11.7	13	7	34	19	10
11/32	13	13	7	34	20	10
3/8	13.7	13	8.3	35	20	10
7/16	15.5	13	9.5	36	21	10
1/2	18	13	10.5	37	26	10
9/16	19.2	13	10.5	37	28	10

RS2445A/9	9 Pieces set/Rail 150mm	(g)
3/16, 1/4, 9/32, 5/16, 11/32, 3/8, 7/16, 1/2, 9/16		220

AS2445A (inch)	D ₁ (mm)	D ₂ (mm)	H (mm)	L (mm)	(g)	(pcs.)
1/4	9.6	12.9	5.7	31.8	18	10
5/16	11.7	12.9	7	34.6	21	10
3/8	13.5	12.9	8.3	35.1	21	10
7/16	15.5	12.9	9.5	39.1	25	10
1/2	17.2	12.9	10.5	40.1	27	10

2440T (E)	D ₁ (mm)	D ₂ (mm)	H (mm)	L (mm)	(g)	(pcs.)
E 6	8	13	5.4	31.9	20	10
E 8	9.8	13	7	33.1	20	10
E10	11.7	13	8.2	33.6	21	10
E12	14.2	13	9.3	35.1	24	10

2441M (mm)	D ₁ (mm)	D ₂ (mm)	H (mm)	L (mm)	(g)	(pcs.)
6	10.2	13	3.5	31.5	19	10
7	11.3	13	4	33	19	10
8	12.3	13	5	33	19	10
10	14.5	13	6	32.5	21	10
12	16.8	13	7	34	21	10
13	18	13	8	35	21	10
14	20	13	8.5	37	28	10

2440M / 2440A

6-point Universal Sockets
6-kant Gelenk-Einsätze
Douilles articulées, 6-pans

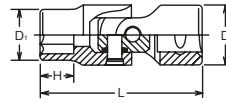

2445M / 2445A

12-point Universal Sockets
12-kant Gelenk-Einsätze
Douilles articulées, 12-pans

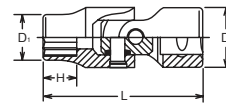

RS2445A/9

Socket Set on Rail
Steckschlüsselsatz auf Schiene
Jeu de douilles sur rail



AS2445A

12-point Universal Sockets
12-kant Gelenk-Einsätze
Douilles articulées, 12-pans

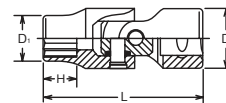

2440T

TORX® Universal Sockets
TORX® Gelenk-Einsätze
Douilles articulées TORX®

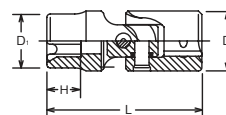

2441M

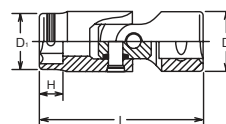

Nut Grip Universal Sockets **Nut Grip®**
Gelenk-Einsätze mit zweifacher Kugelhalterung
Douilles articulées à billes de retenue



Hand Sockets Hand Steckschlüssel 1/4"

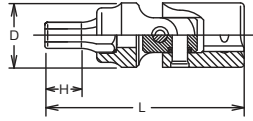

2430M Universal Hex Sockets Gelenk-Einsätze für Schrauben mit Innensechskant Douilles articulées, 6-pans mâles



2430M (mm)	D (mm)	H (mm)	L (mm)	 (g)	 (pcs.)
3	13	5.5	40	18	10
4	13	5.5	40	18	10
5	13	6.5	40	20	10
6	13	7.5	40	21	10

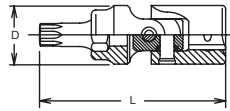

2430T TORX® Universal Sockets TORX® Gelenk-Einsätze Douilles articulées TORX®

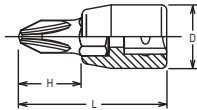

2430T (T)	D (mm)	L (mm)	 (g)	 (pcs.)
T 8	13	42	22	10
T 9	13	42	22	10
T10	13	42	22	10
T15	13	42	22	10
T20	13	42	22	10
T25	13	42	22	10
T27	13	42	22	10
T30	13	42	22	10

2000-28 (PH) PH Bit Sockets Steckschlüssel für Kreuzschlitzschrauben, PH Douilles tournevis pour vis à empreinte PH



2000-28 (PH)	D (mm)	H (mm)	L (mm)	 (g)	 (pcs.)
1	11.9	12	28	10	10
2	11.9	12	28	11	10
3	11.9	12	28	12	10
4	13.1	11	28	14	10

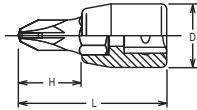

2000-28 (PZ) PZ Bit Sockets Steckschlüssel für Kreuzschlitzschrauben, PZ Douilles tournevis pour vis à empreinte PZ

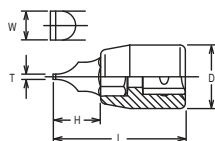

2000-28 (PZ)	D (mm)	H (mm)	L (mm)	 (g)	 (pcs.)
PZ1	11.9	12	28	10	10
PZ2	11.9	12	28	11	10
PZ3	11.9	12	28	12	10

2005-25 Bit Sockets for Slotted Head Steckschlüssel für Schlitzschrauben Douilles tournevis pour vis à fente



2005-25	T×W (mm)	D (mm)	H (mm)	L (mm)	 (g)	 (pcs.)
3	0.5× 3	11.9	9	25	9	10
4	0.8× 4	11.9	9	25	10	10
5	1.0× 5.5	11.9	9	25	10	10
6	1.2× 6.5	13.1	9	25	11	10
8	1.2× 8	13.1	9	25	12	10
9	1.6× 8	13.1	9	25	12	10
10	1.6×10	14.3	9	25	13	10

1/4"

Hand Sockets
Hand Steckschlüssel
Douilles à main

2010M-25 (mm)	D (mm)	H (mm)	L (mm)	(g)	(pcs.)
1.5	11.9	9	25	9	10
2	11.9	9	25	9	10
2.5	11.9	9	25	9	10
3	11.9	9	25	9	10
4	11.9	9	25	9	10
5	11.9	9	25	10	10
6	11.9	9	25	12	10
7	13.1	8	25	12	10
8	13.1	8	25	14	10
10	14.3	8	25	17	10
12	16.4	8	25	36	10

2010M-100 (mm)	D (mm)	H (mm)	L (mm)	(g)	(pcs.)
2	11.9	84	100	30	10
2.5	11.9	84	100	30	10
3	11.9	84	100	30	10
4	11.9	84	100	30	10
5	13.1	83	100	30	10
6	13.1	83	100	35	10
7	13.1	83	100	35	10
8	13.1	83	100	38	10
10	14.3	83	100	45	10
12	16.4	83	100	107	10

RS2010M/7-L25	7 Pieces set/Rail 150mm	(g)
3, 4, 5, 6, 7, 8, 10		115

RS2010A/8-L25	8 Pieces set/Rail 150mm	(g)
1/8, 5/32, 3/16, 7/32, 1/4, 9/32, 5/16, 3/8		130

2011M-50 (mm)	D (mm)	H (mm)	L (mm)	(g)	(pcs.)
3	11.9	34	50	16	10
4	11.9	34	50	17	10
5	11.9	34	50	18	10
6	11.9	34	50	18	10

Ball point bit sockets have less strength due to the special design. Make sure to use them correctly.



2020-28 (XZN)	D (mm)	H (mm)	L (mm)	(g)	(pcs.)
M4	11.9	12	28	12	10
M5	11.9	12	28	12	10
M6	11.9	12	28	13	10
M8	13.1	11	28	14	10

2020-50 (XZN)	D (mm)	H (mm)	L (mm)	(g)	(pcs.)
M4	11.9	34	50	20	10
M5	11.9	34	50	20	10
M6	11.9	34	50	22	10
M8	13.1	33	50	24	10

XZN

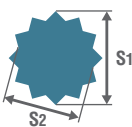

XZN		M4	M5	M6	M8	M10	M12	M14	M16	M18
S ₁	(ref. mm)	3.6	4.8	6.1	7.3	9.7	11.5	13.3	15.7	16.9
S ₂	(ref. mm)	3.1	4.1	5.1	6.1	8.1	9.7	11.2	13.2	14.2

2010M-25 / -100 2010A-25

Inhex Bit Sockets
Steckschlüssel für Innensechskant-Schrauben
Douilles tournevis pour vis 6-pans creux

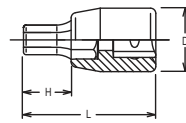

2010A-25 (inch)	D (mm)	H (mm)	L (mm)	(g)	(pcs.)
1/8	11.9	9	25	9	10
5/32	11.9	9	25	9	10
3/16	11.9	9	25	10	10
7/32	11.9	9	25	11	10
1/4	11.9	9	25	12	10
9/32	13.1	8	25	12	10
5/16	13.1	8	25	14	10
3/8	14.3	8	25	17	10
7/16	18.1	8	25	35	10

RS2010M/7-L25 RS2010A/8-L25

Socket Set on Rail
Steckschlüsselsatz auf Schiene
Jeu de douilles sur rail



2011M-50

Ballpoint Inhex Sockets
Steckschlüssel mit Kugelkopf, für Innensechskant-Schrauben
Douilles tournevis avec tête sphérique pour vis 6-pans creux

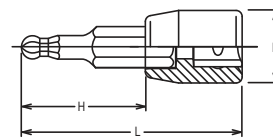

2020-28 / -50

XZN Bit Sockets
Steckschlüssel für XZN Schrauben
Douilles tournevis pour empreinte XZN

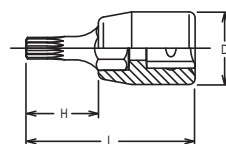

Z-SERIES
HAND
TITANIUM
SCREWDRIVERS
ACCESSORIES
IMPACT
SLEEVE-DRIVE
PROTECTOR
INDUSTRIAL
AUTOMOTIVE
MOTORCYCLE
CONSTRUCTION
SPARE PART

2025-28 / -80 (T)

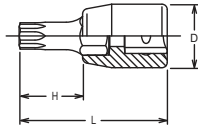
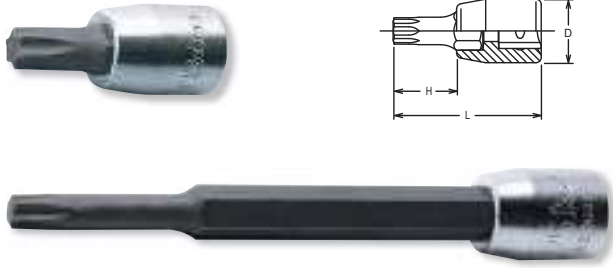

 TORX® Bit Sockets
TORX® Bit-Steckschlüssel
Douilles tournevis, TORX®



2025-28 (T)	D (mm)	H (mm)	L (mm)	(g)	(pcs.)
T 8	11.9	12	28	10	10
T 9	11.9	12	28	10	10
T10	11.9	12	28	10	10
T15	11.9	12	28	10	10
T20	11.9	12	28	11	10
T25	11.9	12	28	11	10
T27	11.9	12	28	12	10
T30	11.9	12	28	12	10
T40	11.9	12	28	13	10

2025-80 (T)	D (mm)	H (mm)	L (mm)	(g)	(pcs.)
T10	11.9	64	80	40	10
T15	11.9	64	80	40	10
T20	11.9	64	80	42	10
T25	11.9	64	80	42	10
T27	11.9	64	80	45	10
T30	11.9	64	80	45	10
T40	11.9	64	80	50	10

RS2025/7-L28

  Socket Set on Rail
Steckschlüsselsatz auf Schiene
Jeu de douilles sur rail



RS2025/7-L28	7 Pieces set/Rail 150mm	(g)
T10, T15, T20, T25, T27, T30, T40		119

TORX® (T)

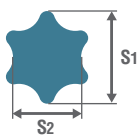

T	T8	T9	T10	T15	T20	T25	T27	T30	T40	T45	T50	T55	T60	T70	T80	T90	T100
S ₁ (ref. mm)	2.3	2.5	2.7	3.3	3.9	4.5	5.0	5.6	6.7	7.9	8.9	11.3	13.3	15.6	17.6	20.0	22.2
S ₂ (ref. mm)	1.7	1.8	2.0	2.3	2.8	3.2	3.6	4.0	4.8	5.6	6.2	8.0	9.5	11.1	12.7	14.2	15.8

2025-28 (TH)

 Tamper-Resistant TORX® Bit Sockets
Tamper-Resistant TORX® Bit-Steckschlüssel
Douilles tournevis, Tamper-Resistant TORX® 

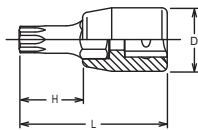

2025-28 (TH)	D (mm)	H (mm)	L (mm)	(g)	(pcs.)
T10H	11.9	12	28	10	10
T15H	11.9	12	28	10	10
T20H	11.9	12	28	11	10
T25H	11.9	12	28	11	10
T27H	11.9	12	28	12	10
T30H	11.9	12	28	12	10
T40H	11.9	12	28	13	10

 Tamper Resistant TORX® Bit Sockets have less strength due to their special design. Make sure to use it correctly.

RS2025/7-HOLE

  Socket Set on Rail
Steckschlüsselsatz auf Schiene
Jeu de douilles sur rail



RS2025/7-HOLE	7 Pieces set/Rail 150mm	(g)
T10H, T15H, T20H, T25H, T27H, T30H, T40H		119



2025-28 (IP)	D (mm)	H (mm)	L (mm)	(g)	(pcs.)
8IP	11.9	12	28	10	10
9IP	11.9	12	28	10	10
10IP	11.9	12	28	10	10
15IP	11.9	12	28	10	10
20IP	11.9	12	28	11	10
25IP	11.9	12	28	11	10
27IP	11.9	12	28	12	10
30IP	11.9	12	28	12	10
40IP	11.9	12	28	13	10

RS2025/7-IP	7 Pieces set/Rail 150mm	(g)
10IP, 15IP, 20IP, 25IP, 27IP, 30IP, 40IP		119

2025-28 (IP)



TORXPLUS® Bit Sockets
TORXPLUS® Bit-Steckschlüssel
Douilles tournevis, TORXPLUS®

TORXplus

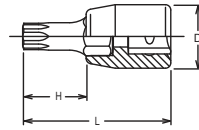

RS2025/7-IP



Socket Set on Rail
Steckschlüsselsatz auf Schiene
Jeu de douilles sur rail



TORXPLUS® (IP)

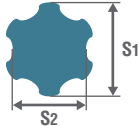

IP		8IP	9IP	10IP	15IP	20IP	25IP	27IP	30IP	40IP	45IP	50IP	55IP	60IP	70IP
S ₁	(ref. mm)	2.3	2.5	2.7	3.3	3.9	4.5	5.0	5.6	6.7	7.9	8.9	11.3	13.3	15.6
S ₂	(ref. mm)	1.7	1.8	2.0	2.3	2.8	3.2	3.6	4.0	4.8	5.6	6.2	8.0	9.5	11.1

2025-28 (IPR)	D (mm)	H (mm)	L (mm)	(g)	(pcs.)
8IPR	11.9	12	28	10	10
9IPR	11.9	12	28	10	10
10IPR	11.9	12	28	10	10
15IPR	11.9	12	28	10	10
20IPR	11.9	12	28	11	10
25IPR	11.9	12	28	11	10
27IPR	11.9	12	28	12	10
30IPR	11.9	12	28	12	10
40IPR	13.1	12	28	13	10

RS2025/7-IPR	7 Pieces set/Rail 150mm	(g)
10IPR, 15IPR, 20IPR, 25IPR, 27IPR, 30IPR, 40IPR		119

2025-28 (IPR)



Tamper-Resistance TORXPLUS® Bit Sockets
Tamper-Resistance TORXPLUS® Bit-Steckschlüssel
Douilles tournevis TORXPLUS® avec trou

TORXplus

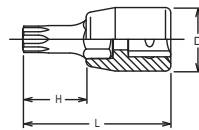

RS2025/7-IPR



Socket Set on Rail
Steckschlüsselsatz auf Schiene
Jeu de douilles sur rail



TORXPLUS® (IPR)

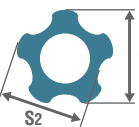

IPR		8IPR	9IPR	10IPR	15IPR	20IPR	25IPR	27IPR	30IPR	40IPR	45IPR	50IPR	55IPR
S ₁	(ref. mm)	2.2	2.4	2.6	3.1	3.6	4.1	4.7	5.2	6.3	7.4	8.4	10.6
S ₂	(ref. mm)	2.0	2.2	2.4	2.8	3.3	3.8	4.3	4.8	5.7	6.7	7.6	9.7

	D ₁ (mm)	D ₂ (mm)	L (mm)	(g)	(pcs.)
2137	12	12	22.5	13	10

For DIN3126 C6.3 Bits
Für DIN3126 C6.3 Bits
Pour DIN3126 C6.3 Embouts

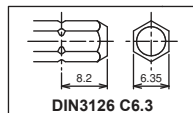

2137



Bit Holder
Klingenhalter
Porte-embouts

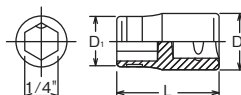

	D ₁ (mm)	D ₂ (mm)	L (mm)	(g)	(pcs.)
2138	16	16	26	32	10

For DIN3126 C8 Bits
Für DIN3126 C8 Bits
Pour DIN3126 C8 Embouts

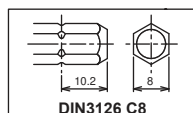

2138



Bit Holder
Klingenhalter
Porte-embouts

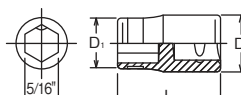

Hand Sockets Hand Steckschlüssel Douilles à main

1/4"

Z-SERIES

HAND

TITANIUM

SCREWDRIVERS ACCESSORIES

IMPACT

SLEEVE-DRIVE

PROTECTOR

INDUSTRIAL

AUTOMOTIVE

MOTORCYCLE

CONSTRUCTION

SPARE PART

2753PS Reversible Ratchet (Short) Knarre kurz, verstellbar Cliquet courte, réversible

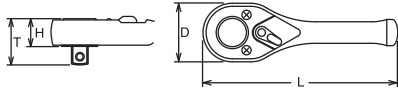

* Renewal Kits → 2753RK → P306

	D (mm)	T (mm)	H (mm)	L (mm)	(g)	(pce.)
2753PS	22	18.7	11.4	75	55	5

2753J Reversible Ratchet Knarre, verstellbar Cliquet, réversible



* Renewal Kits → 2753RK → P306

2753P Reversible Ratchet Knarre, verstellbar Cliquet, réversible



* Renewal Kits → 2753RK → P306

2753N Reversible Ratchet Knarre, verstellbar Cliquet, réversible



* Renewal Kits → 2753RK → P306

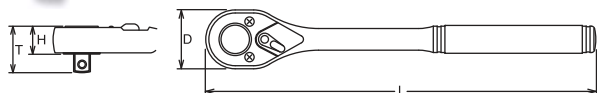

	D (mm)	T (mm)	H (mm)	L (mm)	(g)	(pce.)
2753J	22	18.7	11.4	115	77	1
2753P	22	18.7	11.4	115	87	1
2753N	22	18.7	11.4	115	90	1

2753P-160 Reversible Ratchet (Long) Verstellbare Knarre, lang Cliquet réversible, longue



* Renewal Kits → 2753RK → P306

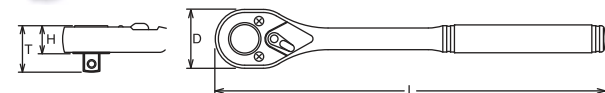

	D (mm)	T (mm)	H (mm)	L (mm)	(g)	(pce.)
2753P-160	22	18.7	11.4	160	107	1

⚠ 2753P-160 have longer handle than standard, and can be loaded to excessive torque value. In the interest of your own safety always apply load evenly and progressively to avoid breakage and possible injury.

2753JB Reversible Ratchet with quick release button Knarre, verstellbar mit Entriegelungsknopf Cliquet, réversible avec bouton de débrayage



* Renewal Kits → 2753BRK → P306

2753PB Reversible Ratchet with quick release button Knarre, verstellbar mit Entriegelungsknopf Cliquet, réversible avec bouton de débrayage



* Renewal Kits → 2753BRK → P306

2753NB Reversible Ratchet with quick release button Knarre, verstellbar mit Entriegelungsknopf Cliquet, réversible avec bouton de débrayage



* Renewal Kits → 2753BRK → P306

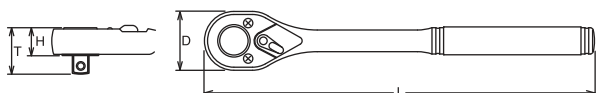

	D (mm)	T (mm)	H (mm)	L (mm)	(g)	(pce.)
2753JB	22	18.7	11.4	115	77	1
2753PB	22	18.7	11.4	115	87	1
2753NB	22	18.7	11.4	115	90	1

⚠ Reversible Ratchet with Quick Release Button :
Sockets and accessories are safely locked. By pushing the button the sockets or extension bars are released from the ratchet.

Umstellbare Knarre mit Entriegelungsknopf :
Steckschlüssel und Zubehörteile werden sicher und fest gehalten. Bei Drücken des Knopfes lösen sich die Teile.

Cliquet réversible à verrouillage :
Les douilles et accessoires ne peuvent plus tomber. Une pression du pouce sur le bouton suffit pour les libérer.



* Renewal Kits → 2753RK → P306



* Renewal Kits → 2753RK → P306

	D (mm)	T (mm)	H (mm)	L (mm)	(g)	(pce.)
2774JS	22	18.7	11.4	116	113	1
2774PS	22	18.7	11.4	116	110	1



* Renewal Kits → 2753RK → P306



* Renewal Kits → 2753RK → P306



* Renewal Kits → 2753RK → P306

	D (mm)	T (mm)	H (mm)	L (mm)	(g)	(pce.)
2774J	22	18.7	11.4	161	130	1
2774P	22	18.7	11.4	161	126	1
2774N	22	18.7	11.4	161	130	1

2774JS Flexible Ratchet, reversible
Gelenk-Knarre, verstellbar
Cliquet articulé, réversible



2774PS Flexible Ratchet, reversible
Gelenk-Knarre, verstellbar
Cliquet articulé, réversible

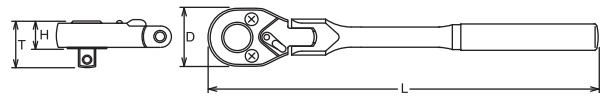

2774J Flexible Ratchet, reversible
Gelenk-Knarre, verstellbar
Cliquet articulé, réversible



2774P Flexible Ratchet, reversible
Gelenk-Knarre, verstellbar
Cliquet articulé, réversible



2774N Flexible Ratchet, reversible
Gelenk-Knarre, verstellbar
Cliquet articulé, réversible

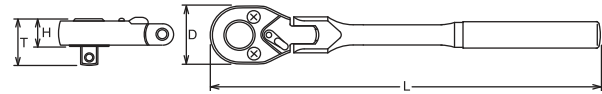

* Renewal Kits → 2755RK → P307

	D (mm)	L (mm)	(g)	(pcs.)
2755	26	40	80	10

2755 Ratchet Adaptor
Aufsteckknarre
Cliquet adaptable

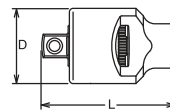

	D (mm)	L (mm)	(g)	(pcs.)
2756	22	20	19	10

2756 Quick Spinner
Rändel-Drehscheibe
Lanceur

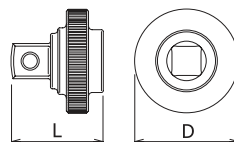

Hand Sockets Hand Steckschlüssel Douilles à main

1/4"

Z-SERIES

HAND

TITANIUM

ACCESSORIES

SCREWDRIVERS

IMPACT

SLEEVE-DRIVE

PROTECTOR

INDUSTRIAL

AUTOMOTIVE

MOTORCYCLE

CONSTRUCTION

SPARE PART

2760 Extension Bars Verlängerungen Rallonges

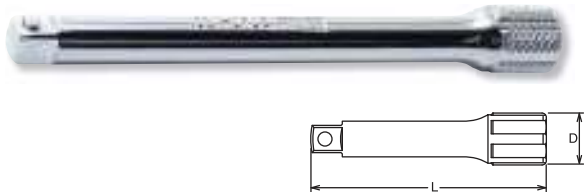

	D (mm)	L (mm)	(g)	(pcs.)
2760-28	12.3	28	14	10
2760-50	12.3	50	23	10
2760-75	12.3	75	35	10
2760-100	12.3	100	44	10
2760-150	12.3	150	63	10
2760-200	12.3	200	83	10
2760-250	12.3	250	103	10
2760-300	12.3	300	122	2
2760-350	12.3	350	145	2
2760-400	12.3	400	160	2
2760-600	12.3	600	240	2

PK2760/6 Extension Set in Plastic Box Verlängerungen in Kunststoffkassette Jeu de rallonges en boîte plastique



PK2760/6 6 Pieces Set/△=430g PLASTIC TRAY

Extension Bars	
2760 Extension Bars	28, 50, 100, 150, 200, 250

Rotation and general handling of extensions with oily hands is greatly improved with the **Koken** developed 6 point knurling. Also the **Koken** 6 point knurling stops the extensions from rolling around the work area.



Durch die von **Koken** entwickelte 6 fache Rändelung wird die Handhabung deutlich erleichtert. Außerdem wird das Herumrollen der Verlängerungen wirksam verhindert.

La manipulation des rallonges est grandement facilitée par le profil moleté développé par **Koken**. Ce même profil empêche le roulement intempestif des rallonges sur le plan de travail.

2763 Wobble-Fix Extension Bars Winkel-Verlängerungen Rallonges angulaires

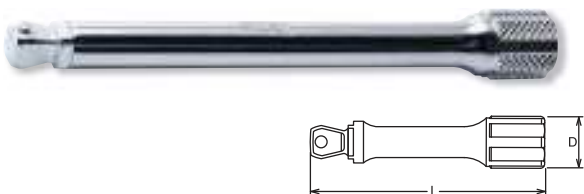

	D (mm)	L (mm)	(g)	(pcs.)
2763-28	12.3	28	14	10
2763-50	12.3	50	23	10
2763-75	12.3	75	33	10
2763-100	12.3	100	43	10
2763-150	12.3	150	62	10
2763-200	12.3	200	80	10
2763-250	12.3	250	100	10

PK2763/6 6 Pieces Set/△=420g PLASTIC TRAY

Extension Bars	
2763 Wobble-Fix Extension Bars	28, 50, 100, 150, 200, 250

Wobble-Fix Extension Bar

- Two way usage
a) In a fixed position, as a normal extension bar
b) In a half-fixed position, as a flexible extension bar providing a 15° angle operation

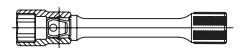

Winkel-Verlängerungen

- Winkelverlängerungen lassen sich in zwei Einstellungen verwenden
a) voll eingesteckt und starr,
b) halb eingesteckt, mit einem Arbeitswinkel von 15°.

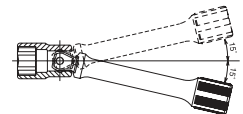

Rallonges angulaires

- Deux utilisations possibles
a) comme rallonge normale, dans une position fixe
b) comme une rallonge angulaire avec une possibilité d'inclinaison jusqu'à 15°

⚠ The Wobble-Fix Extension Bar has less strength than normal extension bar due to it's specific design with a reduced square drive. Make sure to use it correctly.

2762 Flexible Extension Bar Biegsame Verlängerung Rallonge flexible

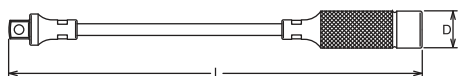

	D (mm)	L (mm)	(g)	(pcs.)
2762	13	300	90	2

2120 Magnetic Head Magnetkopf Tête aimantée

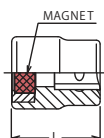

	L (mm)	(g)	(pcs.)
2120	17.5	21	10

1/4" Hand Sockets Hand Steckschlüssel Douilles à main

* Renewal Kits → 2768RK → P309

	D (mm)	L (mm)	(g)	(pcs.)
2768J	14	130	73	5
2768P	14	130	70	10

* Renewal Kits → 2768RK → P309

	H (mm)	L (mm)	(g)	(pcs.)
2769N				
150	50	150	73	2
220	120	220	100	2

 Plastic or rubber handles are not intended to act as insulation.
Plastik-oder Gummigriffe stellen keinen Isolierschutz dar.
Les poignées en plastique ou en caoutchouc ne garantissent aucune isolation électrique.



WOBBLE-FIX
EXTENSION BAR



	H (mm)	L (mm)	(g)	(pcs.)
2769NWF				
150	50	150	73	2
220	120	220	100	2

	L (mm)	(g)	(pcs.)
2769H	160	180	5

2768J Hinge Handle
Gelenkgriff
Poignée articulée



2768P Hinge Handle
Gelenkgriff
Poignée articulée

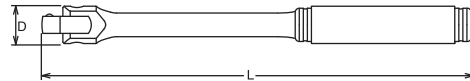

2769N-150 / -220 Spin Type Handle
Drehgriff
Poignée emmanchée 

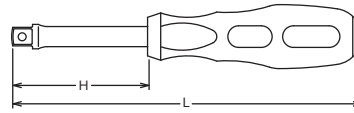

2769NWF-150 / -220 Spin Type Handle(Wobble-Fix)
Drehgriff, Wobble-Fix
Poignée emmanchée, angulaire 

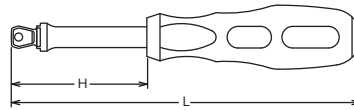

2769H Folding Socket Driver
Klapp-Drehgriff
Poignée tournevis articulée

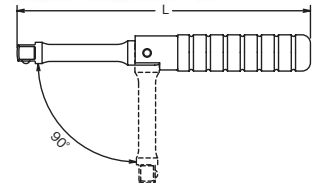

Z-SERIES
HAND
TITANIUM
ACCESSORIES
SCREWDRIVERS
IMPACT
SLEEVE-DRIVE
PROTECTOR
INDUSTRIAL
AUTOMOTIVE
MOTORCYCLE
CONSTRUCTION
SPARE PART

Z-SERIES
HAND
TITANIUM
SCREWDRIVERS ACCESSORIES
IMPACT
SLEEVE-DRIVE
PROTECTOR
INDUSTRIAL
AUTOMOTIVE
MOTORCYCLE
CONSTRUCTION
SPARE PART

2770 Universal Joint
Gelenk-Einsatz
Cardan universel

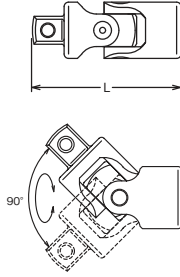

	L (mm)	(g)	(pcs.)
2770	33	20	10
2771	31	20	10

2771 Universal Joint
Gelenk-Einsatz
Joint articulé

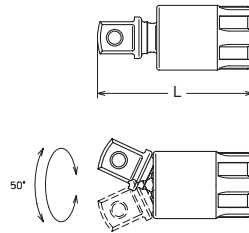

2780 Speed Handle
Winde
Vilebrequin

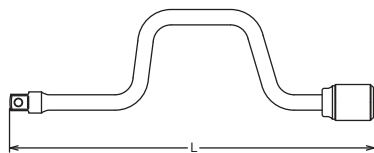

	L (mm)	(g)	(pce.)
2780	350	250	1

2785 T-Handle
T-Griff
Poignée coulissante

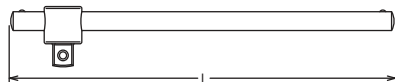



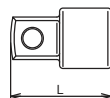

	L (mm)	(g)	(pcs.)
2785	115	36	10

2233A Adaptor
Verbindungsstück
Augmentateur





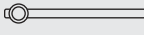







	(sq.)	(sq.)	L (mm)	(g)	(pcs.)
2233A	1/4"	3/8"	22	16	10

ESH2001 16 Pieces Set/△△=630g	
METAL CASE:W160×H100×T28mm	
Sockets	Accessories
 2410M Surface Drive Sockets 4, 5, 5.5, 6, 7, 8, 9, 10, 11, 12, 13	 2753J  2763-50  2760-150  2770  2785

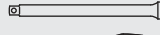



ESH2001 Socket Set
Steckschlüssel Satz
Jeu de clés à douille



ENH2003 26 Pieces Set/△△=980g	
METAL CASE:W310×H86×T40mm	
Sockets	Accessories
 2400M 6-pt. Sockets 5.5, 6, 7, 8, 9, 10, 11, 12, 13, 14  108P PH Bits 1, 2  108S Slotted Bits 4, 6, 8  108H Hex Bits 3, 4, 5, 6	 2753J  2760-50  2760-150  2769N-150  2770  2785  2137



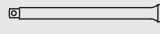
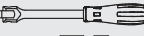

ENH2003 Socket Set
Steckschlüssel Satz
Jeu de clés à douille





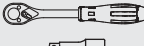

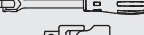

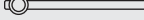



2251M 17 Pieces Set/△△=725g	
METAL CASE:W192×H122×T30mm	
Sockets	Accessories
 2400M 6-pt. Sockets 4, 4.5, 5, 5.5, 6, 7, 8, 9, 10, 11, 13	 2753J  2760-50  2760-150  2768J  2770  2785

2251M / 2251A Socket Set
Steckschlüssel Satz
Jeu de clés à douille



2251A 15 Pieces Set/△△=700g	
METAL CASE:W192×H122×T30mm	
Sockets	Accessories
 2400A 6-pt. Sockets 3/16, 7/32, 1/4, 9/32, 5/16, 11/32, 3/8, 7/16, 1/2	 2753J  2760-50  2760-150  2768J  2770  2785

2258M Socket Set
Steckschlüssel Satz
Jeu de clés à douille

2258M 31 Pieces Set/△△=965g	
METAL CASE:W240×H100×T32mm	
Sockets	Accessories
 2400M 6-pt. Sockets 4, 4.5, 5, 5.5, 6, 7, 8, 9, 10, 11, 13  2000.28 Bit Sockets 1, 2, 3  2005.25 Bit Sockets 4, 6  2010M.25 Bit Sockets 3, 4, 5, 6, 8  2025.28 Bit Sockets T10, T15, T20, T25, T30	 2753J  2760-100  2769N-150  2770  2785



Hand Sockets Hand Steckschlüssel Douilles à main

1/4"

Z-SERIES
HAND
TITANIUM
SCREWDRIVERS ACCESSORIES
IMPACT
SLEEVE-DRIVE
PROTECTOR
INDUSTRIAL
AUTOMOTIVE
MOTORCYCLE
CONSTRUCTION
SPARE PART

2259M Socket Set
Steckschlüssel Satz
Jeu de clés à douille



2259M		31 Pieces Set/△=991g	
METAL CASE:W240×H100×T32mm			
Sockets		Accessories	
	2400M 6-pt. Sockets 4, 4.5, 5, 5.5, 6, 7, 8, 9, 10, 11, 13		2774JS
	2000.28 Bit Sockets 1, 2, 3		2760-100
	2005.25 Bit Sockets 4, 6		2769N-150
	2010M.25 Bit Sockets 3, 4, 5, 6, 8		2770
	2025.28 Bit Sockets T10, T15, T20, T25, T30		2785

2263A Socket Set
Steckschlüssel Satz
Jeu de clés à douille



2263A		29 Pieces Set/△=940g	
METAL CASE:W240×H100×T32mm			
Sockets		Accessories	
	2400A 6-pt. Sockets 1/8, 5/32, 3/16, 7/32, 1/4, 9/32, 5/16, 11/32, 3/8, 7/16, 1/2		2753N
	2000.28 Bit Sockets 1, 2, 3		2760-100
	2010A.25 Bit Sockets 1/8, 5/32, 3/16, 7/32, 1/4, 9/32, 5/16		2769N-150
	2025.28 Bit Sockets T10, T15, T20, T25, T30		2770
			2785

2275 Socket Set
Steckschlüssel Satz
Jeu de clés à douille



2275		19 Pieces Set/△=880g	
METAL CASE:W192×H122×T30mm			
Sockets		Accessories	
	2400M 6-pt. Sockets 5.5, 6, 7, 8, 10, 12, 13		2753J
	2000.28 Bit Sockets 1, 2, 3		2763-50
	2005.25 Bit Sockets 6, 8		2769N-150
	2010M.25 Bit Sockets 3, 4, 5, 6		

2276 Socket Set with Bits and Accessories
Bit Satz mit Zubehör
Jeu d'embouts et avec accessoires









2276		19 Pieces Set/△=640g	
METAL CASE:W192×H122×T30mm			
Bits		Accessories	
	108P PH Bits 1, 2, 3		2753PS
	108S Slotted Bits 4, 5, 6		2769N-150
	108H Hex Bits 3, 4, 5, 6		2137
	108T TORX® Bits T10, T15, T20, T25, T27, T30		

2277 Socket Set
Steckschlüssel Satz
Jeu de clés à douille





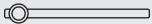



2277		21 Pieces Set/△=1,240g	
METAL CASE:W310×H86×T50mm			
Sockets		Accessories	
	2400M 6-pt. Sockets 5.5, 6, 7, 8, 9, 10, 11, 12, 13		2753J
	2300M 6-pt. Deep Sockets 5.5, 6, 7, 8, 9, 10, 11, 12, 13		2763-75
			2769N-150

P2201AM		25 Pieces Set/△=800g	
PLASTIC CASE:W245xH120xT45mm			
Sockets	Accessories		
 2400M 6-pt. Sockets 4, 5, 5.5, 6, 7, 8, 9, 10, 11, 12, 13		2753J	
		2760-100	
 2400A 6-pt. Sockets 3/16, 7/32, 1/4, 9/32, 5/16, 11/32, 3/8, 7/16, 1/2		2769N-150	
		2770	
		2785	









P2201AM Socket Set
Steckschlüssel Satz
Jeu de clés à douille



P2251M		18 Pieces Set/△=770g	
PLASTIC CASE:W245xH120xT45mm			
Sockets	Accessories		
 2400M 6-pt. Sockets 4, 4.5, 5, 5.5, 6, 7, 8, 9, 10, 11, 12, 13		2753J	
		2760-50	
		2760-150	
		2768J	
		2770	
		2785	

P2251M Socket Set
Steckschlüssel Satz
Jeu de clés à douille

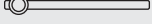

P2258M		31 Pieces Set/△=860g	
PLASTIC CASE:W245xH120xT45mm			
Sockets	Accessories		
 2400M 6-pt. Sockets 4, 5, 5.5, 6, 7, 8, 9, 10, 11, 12, 13		2753J	
 2000.28 Bit Sockets 1, 2, 3		2760-100	
 2005.25 Bit Sockets 4, 6		2769N-150	
 2010M.25 Bit Sockets 3, 4, 5, 6, 8		2770	
 2025.28 Bit Sockets T10, T15, T20, T25, T30		2785	

P2258M Socket Set
Steckschlüssel Satz
Jeu de clés à douille



ABS Case - PE foam insert
Kunststoffkassette - Weichschaumeinlage
Coffret en ABS - Inserts en mousse

3400M / 3400A

6-point Sockets
6-kant Steckschlüssel
Douilles 6-pans

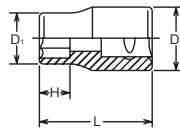

3405M / 3405A

12-point Sockets
12-kant Steckschlüssel
Douilles 12-pans

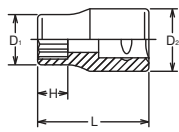

FLAT DRIVE®

Flat drive is designed to guarantee a flat surface contact between the socket and the bolt/nut. The Flat contact reduces wear and allows to transmit a higher torque value. The Flat Drive System is also used for the square drive end as well as the hexagonal or bi-hexagonal openings of the socket.

Das Flat Drive Design sorgt für die optimale Kraftübertragung zwischen den Flächen des Steckschlüssels und der Schraube. Dies erlaubt eine Übertragung von höheren Drehmomenten. Das Flat Drive System findet ebenfalls bei allen Antriebsvierkanten sowie bei 6-kant und 12-kant Profilen Verwendung.

Le profil Flat Drive garantit un contact optimal entre la douille et l'écrou. Ce contact « à plat » réduit l'usure et permet la transmission d'un couple plus élevé. Ce système Flat Drive est utilisé pour tous les carrés conducteurs ainsi que pour toutes nos douilles 6-pans et 12-pans.

RS3400M/12

Socket Set on Rail
Steckschlüsselsatz auf Schiene
Jeu de douilles sur rail



RS3400A/9

Socket Set on Rail
Steckschlüsselsatz auf Schiene
Jeu de douilles sur rail



3400M 3405M (mm)	D ₁ (mm)	D ₂ (mm)	H (mm)	L (mm)	(g)	(pcs.)
5	8.3	17.3	5	26	20	10
5.5	8.9	17.3	5.5	26	20	10
6	9.9	17.3	6	26	20	10
7	10.8	17.3	6.5	26	20	10
8	12	17.3	7	26	22	10
9	13.3	17.3	7.5	26	23	10
10	14.5	17.3	8	26	24	10
11	15.8	17.3	8.5	26	25	10
12	16.8	17.3	9	26	25	10
13	18	17	9.5	26	24	10
14	19.5	18.5	11	27	31	10
15	20.8	19.5	11.5	28	39	10
16	22	20	12	28	42	10
17	23.3	21.5	12.5	29	51	10
18	24.5	22.5	13	30	51	10
19	25.8	23.5	13.5	30	63	10
20	27	24.5	14	31	75	10
21	28	26	14.5	32	77	10
22	29.5	26.5	15	32	82	10
23	30.8	27.5	15.5	33	95	10
24	32	28.5	16	34	102	10
25	33.3	29.5	16.5	34	115	5
26	34.5	30.5	17	35	129	5

3400A 3405A (inch)	D ₁ (mm)	D ₂ (mm)	H (mm)	L (mm)	(g)	(pcs.)
3/16	8.3	17.3	5	26	20	10
1/4	10.3	17.3	6	26	20	10
9/32	10.8	17.3	6.5	26	20	10
5/16	12	17.3	7	26	22	10
11/32	13.3	17.3	7.5	26	23	10
3/8	13.9	17.3	8	26	23	10
13/32	13.3	17.3	7.5	26	23	10
7/16	15.8	17.3	8.5	26	25	10
1/2	18	17	9.5	26	24	10
9/16	19.5	18.5	11	27	31	10
19/32	20.8	19.5	11.5	28	39	10
5/8	22	20	12	28	42	10
11/16	24.5	22.5	13	30	51	10
3/4	25.8	23.5	13.5	30	63	10
25/32	27	24.5	14	31	75	10
13/16	28	26	14.5	32	77	10
7/8	29.5	26.5	15	32	82	10
15/16	32	28.5	16	34	102	10
1	34.5	30.5	17	35	132	5

RS3400M/12	12 Pieces Set/Rail 300mm	(g)
8, 9, 10, 11, 12, 13, 14, 15, 16, 17, 18, 19		465

RS3405M/12	12 Pieces Set/Rail 300mm	(g)
8, 9, 10, 11, 12, 13, 14, 15, 16, 17, 18, 19		465

RS3400A/9	9 Pieces Set/Rail 200mm	(g)
1/4, 5/16, 3/8, 7/16, 1/2, 9/16, 5/8, 11/16, 3/4		333

RS3405A/9	9 Pieces Set/Rail 200mm	(g)
1/4, 5/16, 3/8, 7/16, 1/2, 9/16, 5/8, 11/16, 3/4		333

3410M (mm)	D ₁ (mm)	D ₂ (mm)	H (mm)	L (mm)	(g)	(pcs.)
5.5	8.9	17.3	5.5	26	20	10
6	9.9	17.3	6	26	20	10
7	10.8	17.3	6.5	26	20	10
8	12	17.3	7	26	22	10
9	13.3	17.3	7.5	26	23	10
10	14.5	17.3	8	26	24	10
11	15.8	17.3	8.5	26	25	10
12	16.8	17.3	9	26	25	10
13	18	17	9.5	26	24	10
14	19.5	18.5	11	27	31	10
15	20.8	19.5	11.5	28	39	10
16	22	20	12	28	42	10
17	23.3	21.5	12.5	29	51	10
18	24.5	22.5	13	30	51	10
19	25.8	23.5	13.5	30	63	10
20	27	24.5	14	31	75	10
21	28	26	14.5	32	77	10
22	29.5	26.5	15	32	82	10
23	30.8	27.5	15.5	33	95	10
24	32	28.5	16	34	102	10



3410M Surface Drive Sockets Surface Drive Steckschlüssel Douilles, Surface Drive

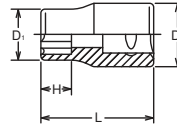

SURFACE DRIVE

Surface drive sockets are designed to retain contact with the flat sides of the nut in order to transmit higher torque and reduce nut wear. These sockets are ideal for using on polished nuts, aluminum nuts and nuts with worn out points.

Das Profil unserer Surface-Drive Steckschlüssel greift die Schraube an deren Flächen. Dies sichert eine höhere Kraftübertragung und verhindert ein Durchrutschen des Steckschlüssels. Diese Steckschlüssel eignen sich besonders für polierte Schrauben, Aluminium Schrauben und Schrauben bei denen die Ecken bereits abgerundet sind.

Notre profil Surface Drive assure le contact entre la douille et les plats de l'écrou. Ceci réduit l'usure et permet la transmission d'un couple plus élevé. C'est une solution idéale pour les écrous polies, celles en aluminium ou arrondies.

RS3410M/12	12 Pieces Set/Rail 300mm	(g)
8, 9, 10, 11, 12, 13, 14, 15, 16, 17, 18, 19		468

RS3410M/12 Socket Set on Rail Steckschlüsselsatz auf Schiene Jeu de douilles sur rail



3400W 3405W (W)	D ₁ (mm)	D ₂ (mm)	H (mm)	L (mm)	(g)	(pcs.)
1/8	13.3	17.3	7.5	26	22	10
3/16	15.8	17.3	8.5	26	25	10
1/4	18	17	9.5	26	24	10
5/16	20.8	19.5	11.5	28	39	10
3/8	24.5	22.5	13	30	51	10
7/16	28	26	14.5	32	81	10
1/2	30.8	27.5	15.5	33	103	10
9/16	34.5	30.5	17	35	128	5

3400W 6-point Whitworth Sockets 6-kant Steckschlüssel, Whitworth Douilles à 6-pans Whitworth

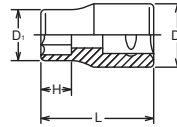

3405W 12-point Whitworth Sockets 12-kant Steckschlüssel, Whitworth Douilles à 12-pans Whitworth

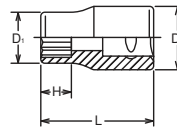

RS3400W/7	7 Pieces Set/Rail 200mm	(g)
1/8, 3/16, 1/4, 5/16, 3/8, 7/16, 1/2		389

RS3400W/7 Socket Set on Rail Steckschlüsselsatz auf Schiene Jeu de douilles sur rail



RS3405W/7	7 Pieces Set/Rail 200mm	(g)
1/8, 3/16, 1/4, 5/16, 3/8, 7/16, 1/2		389

BS W



BS - W	BS	3/16BS	1/4BS	5/16BS	3/8BS	7/16BS	1/2BS	9/16BS	5/8BS	11/16BS	3/4BS	7/8BS
	W	1/8W	3/16W	1/4W	5/16W	3/8W	7/16W	1/2W	9/16W	5/8W	11/16W	3/4W
S	(ref. mm)	8.64	11.30	13.34	15.24	18.03	20.83	23.37	25.65	27.94	30.48	33.35

3415M / 3415A

Double 4-point Sockets
Doppelvierkant Steckschlüssel
Douilles 4-pans, doubles

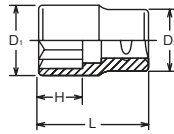

3415M (mm)	D ₁ (mm)	D ₂ (mm)	H (mm)	L (mm)	(g)	(pcs.)
5.5	10.8	17.4	5.5	26	21	10
6	12	17.3	6	26	26	10
7	13.3	17.4	6.5	26	26	10
8	14.5	17.3	7	26	26	10
10	16.8	17.3	8	26	27	10
12	20.8	19.5	9	27	43	10
13	21.9	20	9.5	27	46	10

3415A (inch)	D ₁ (mm)	D ₂ (mm)	H (mm)	L (mm)	(g)	(pcs.)
1/4	12	17.3	6	26	24	10
5/16	14.5	17.3	7	26	26	10
11/32	15.8	17.3	7.5	26	27	10
3/8	16.8	17.3	8	26	27	10
7/16	19.5	18.5	8.5	27	37	10
1/2	22	20	9.5	27	46	10

3425

TORX® Sockets
TORX® Steckschlüssel
Douilles TORX®

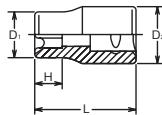

3425 (E)	D ₁ (mm)	D ₂ (mm)	H (mm)	L (mm)	(g)	(pcs.)
E 4	5.6	17.3	4.6	26	18	10
E 5	7	17.3	5.2	26	20	10
E 6	8.3	17.3	5.4	26	21	10
E 7	8.9	17.3	6.6	26	22	10
E 8	9.9	17.3	7	26	23	10
E10	12	17.3	8.2	26	24	10
E11	13.3	17.3	8.7	26	25	10
E12	14.5	17.3	9.3	26	26	10
E14	15.8	17.3	10.6	26	27	10
E16	18	17	11.8	26	27	10

RS3425/9

Socket Set on Rail
Steckschlüsselsatz auf Schiene
Jeu de douilles sur rail



RS3425/9	9 Pieces Set/Rail 200mm	(g)
E4, E5, E6, E7, E8, E10, E12, E14, E16		239

RSX425/14

Socket Set on Rail
Steckschlüsselsatz auf Schiene
Jeu de douilles sur rail



RSX425/14	14 Pieces Set/Rail 300mm	(g)
2425	1/4"	E4, E5, E6, E7, E8
3425	3/8"	E10, E11, E12, E14
4425	1/2"	E16, E18, E20, E22, E24
		550

TORX® (E)

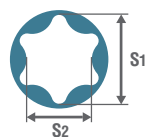

E	E4	E5	E6	E7	E8	E10	E11	E12	E14	E16	E18	E20	E22	E24	E26	E28	E30	E32
S ₁ (ref. mm)	3.7	4.6	5.6	6.1	7.4	9.3	9.9	11.0	12.8	14.6	16.5	18.3	20.1	22.0	23.7	25.5	27.3	29.0
S ₂ (ref. mm)	2.7	3.3	4.0	4.3	5.3	6.8	7.1	7.9	9.2	10.5	11.9	13.2	14.8	15.7	17.5	18.3	20.0	21.3

3400LH

LHSTIX® Sockets
Steckschlüssel mit LHSTIX® Profil
Douilles au profil LHSTIX®

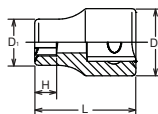

3400LH (LH-S)	D ₁ (mm)	D ₂ (mm)	H (mm)	L (mm)	(g)	(pcs.)
5S	10.8	17.3	5	26	20	10
6S	12	17.3	5.6	26	22	10
8S	15.8	17.3	6.8	26	25	10
10S	18	17	8	26	25	10
12S	22	20	9.2	28	42	10
14S	24.5	22.5	10.4	30	51	10
16S	28	26	11.6	32	77	10

RS3400LH/7

Socket Set on Rail
Steckschlüsselsatz auf Schiene
Jeu de douilles sur rail



RS3400LH/7	7 Pieces Set/Rail 150mm	(g)
5S, 6S, 8S, 10S, 12S, 14S, 16S		315

LHSTIX®

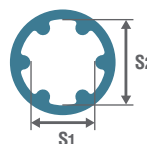

LH-S	LH-5S	LH-6S	LH-8S	LH-10S	LH-12S	LH-14S	LH-16S
S ₁ (ref. mm)	5.6	6.8	9.0	11.3	13.6	15.8	18.1
S ₂ (ref. mm)	7.5	9.0	12.0	15.0	18.0	21.0	24.0

TORX® is a registered trademark of CAMCAR Innovations.
TORX® ist ein registriertes Markenzeichen der Firma CAMCAR Innovations.
TORX® est une marque déposée de CAMCAR Innovations.

LHSTIX® is a registered trademark of OSG SYSTEM PRODUCTS CO., LTD.
LHSTIX® ist ein registriertes Markenzeichen der Firma OSG SYSTEM PRODUCTS CO., LTD.
LHSTIX® est une marque déposée de OSG SYSTEM PRODUCTS CO., LTD.

3450M (mm)	D ₁ (mm)	D ₂ (mm)	H (mm)	L (mm)	(g)	(pcs.)
8	12	17.3	5	26	21	10
10	14.5	17.3	6	26	24	10
11	15.8	17.3	6.5	26	26	10
12	16.8	17.3	7	26	26	10
13	18	17	8	26	28	10
14	19.5	18.5	8.5	27	34	10
15	20.8	19.5	9	27	42	10
16	22	20	9	27	50	10
17	23.3	21.5	9.5	28	62	10
18	24.5	22.5	10.5	29	64	10
19	25.8	23.3	11.5	29	66	10
21	28	26	12	29	85	10
22	29.5	27	12.5	29	90	10
24	32	30	14.5	31	102	10



3450M

Nut Grip Sockets **Nut Grip**[®]
Steckschlüssel mit 2-facher Kugelhalterung
Douilles à billes de retenue

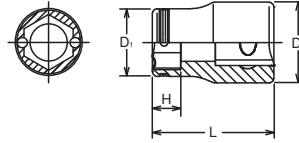

NUT GRIP[®]

Twin balls at the 6-point opening hold bolt/nut tightly for safe and reliable work.

Die zwei Kugeln in der 6-kant Öffnung unserer NUT GRIP Steckschlüssel halten die Schraube sicher im Steckschlüssel. Dies erlaubt ein Arbeiten auch an schwer zugänglichen Stellen.

Les 2 billes dans l'ouverture du 6-pans de la douille retiennent l'écrou de manière sûre et efficace.

RS3450M/8	8 Pieces Set/Rail 200mm	(g)
8, 10, 11, 12, 13, 14, 17, 19		310

RS3450M/8

Socket Set on Rail
Steckschlüsselsatz auf Schiene
Jeu de douilles sur rail



3450MH (mm)	D (mm)	H ₁ (mm)	H ₂ (mm)	L (mm)	(g)	(pcs.)
8	12	5	17	26	30	10
10	14.5	6	17	26	30	10
12	16.8	7	17	26	29	10
13	18	8	17	26	28	10
14	19.5	8.5	17	27	32	10
17	23.3	9.5	17	29	41	10

3450MH

Nut Grip Socket wrench with additional hexagon drive
Nut Grip Steckschlüssel mit zusätzlichem Aussensechskant
Douilles à deux billes de retenue avec tête hexagonale supplémentaire

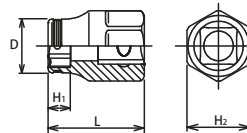

RS3450MH/6	6 Pieces Set/Rail 150mm	(g)
8, 10, 12, 13, 14, 17		230

RS3450MH/6

Socket Set on Rail
Steckschlüsselsatz auf Schiene
Jeu de douilles sur rail



3425 (E)	D ₁ (mm)	D ₂ (mm)	H (mm)	L (mm)	(g)	(pcs.)
E10(2B)	12	17.3	8.2	26	23	10
E12(2B)	14.5	17.3	9.3	26	25	10
E14(2B)	15.8	17.3	10.6	26	26	10
E16(2B)	18.1	17	11.8	26	27	10
E18(2B)	19.5	18.5	12	32	41	10
E20(2B)	21.9	20	14.4	32	52	10

3425 (2B)

TORX[®] Sockets **Nut Grip**[®]
TORX Steckschlüssel mit 2-facher Kugelhalterung
Douilles Torx à deux billes de retenue

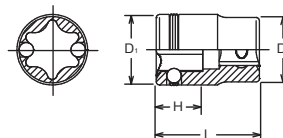

RS3425/4(2B)	4 Pieces Set/Rail 150mm	(g)
E10, E12, E14, E20		150

RS3425/4 (2B)

Socket Set on Rail
Steckschlüsselsatz auf Schiene
Jeu de douilles sur rail



TORX is a registered trademark of CAMCAR Innovations.
TORX ist ein registriertes Markenzeichen der Firma CAMCAR Innovations.
TORX est une marque déposée de CAMCAR Innovations.

OSG is a registered trademark of OSG SYSTEM PRODUCTS CO., LTD.
OSG ist ein registriertes Markenzeichen der Firma OSG SYSTEM PRODUCTS CO., LTD.
OSG est une marque déposée de OSG SYSTEM PRODUCTS CO., LTD.

Z-SERIES
HAND
TITANIUM
SCREWDRIVERS ACCESSORIES
IMPACT
SLEEVE-DRIVE
PROTECTOR
INDUSTRIAL
AUTOMOTIVE
MOTORCYCLE
CONSTRUCTION
SPARE PART

3300X / 3300XA

6-point Sockets, Semi-Deep
6-kant Steckschlüssel, mittel-lang
Douilles, semi-profondes 6-pans

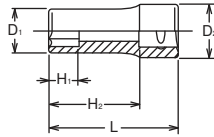

3300X 3305X (mm)	D ₁ (mm)	D ₂ (mm)	H ₁ (mm)	H ₂ (mm)	L (mm)	(g)	(pcs.)
8	12	17.3	9	26.5	40	34	10
9	13	17.3	10	26.5	40	36	10
10	14.5	17.3	11	26.5	40	36	10
11	16	17.2	12	26.5	40	36	10
12	16.8	17.2	13	26.5	40	36	10
13	18	17	14	26.5	40	37	10
14	20	18	16	26.5	40	46	10
15	21	20	16	25.5	40	49	10
16	22	20	17	25.5	40	51	10
17	23.5	22	18	25.5	40	61	10
18	24.5	23	19	24.5	40	68	10
19	25	24	20	24.5	40	75	10

3305X / 3305XA

12-point Sockets, Semi-Deep
12-kant Steckschlüssel, mittel-lang
Douilles, semi-profondes 12-pans

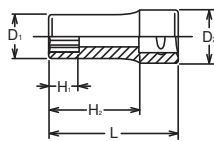

3300XA 3305XA (inch)	D ₁ (mm)	D ₂ (mm)	H ₁ (mm)	H ₂ (mm)	L (mm)	(g)	(pcs.)
1/4	10.3	17.3	7	26.5	40	32	10
5/16	12	17.3	9	26.5	40	34	10
3/8	13.9	17.3	11	26.5	40	36	10
7/16	16	17.2	12	26.5	40	36	10
1/2	18	17	14	26.5	40	37	10
9/16	20	18.5	16	26.5	40	46	10
5/8	22	20	17	25.5	40	51	10
11/16	24.5	22.5	19	24.5	40	68	10
3/4	25	23.5	20	24.5	40	75	10

RS3300X/8 RS3305X/8

Socket Set on Rail
Steckschlüsselsatz auf Schiene
Jeu de douilles sur rail



RS3300X/8	8 Pieces Set/Rail 200mm	(g)
8, 10, 11, 12, 13, 14, 17, 19		405

RS3305X/8	8 Pieces Set/Rail 200mm	(g)
8, 10, 11, 12, 13, 14, 17, 19		405

RS3300XA/9 RS3305XA/9

Socket Set on Rail
Steckschlüsselsatz auf Schiene
Jeu de douilles sur rail



RS3300XA/9	9 Pieces Set/Rail 200mm	(g)
1/4, 5/16, 3/8, 7/16, 1/2, 9/16, 5/8, 11/16, 3/4		460

RS3305XA/9	9 Pieces Set/Rail 200mm	(g)
1/4, 5/16, 3/8, 7/16, 1/2, 9/16, 5/8, 11/16, 3/4		460

3350X

Nut Grip Socket, Semi-Deep **Nut Grip®**
Steckschlüssel mit 2-facher Kugelhalterung, mittel-lang
Douilles à billes de retenue, semi-profondes

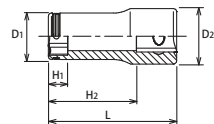

3350X (mm)	D ₁ (mm)	D ₂ (mm)	H ₁ (mm)	H ₂ (mm)	L (mm)	(g)	(pcs.)
8	12	17.4	5	26.5	40	33	10
10	14.5	17.4	6	26.5	40	35	10
12	16.8	17.2	7	26.5	40	40	10
14	19.5	18.5	8.5	26.5	40	48	10

RS3350X/4

Socket Set on Rail
Steckschlüsselsatz auf Schiene
Jeu de douilles sur rail



RS3350X/4	4 Pieces Set/Rail 150mm	(g)
8, 10, 12, 14		165

3300M 3305M (mm)	D ₁ (mm)	D ₂ (mm)	H ₁ (mm)	H ₂ (mm)	L (mm)	(g)	(pcs.)
5.5	8.9	17.3	6.5	41.5	55	37	10
6	9.9	17.3	7	41.5	55	37	10
7	10.6	17.3	8	41.5	55	37	10
8	12	17.3	9	41.5	55	40	10
9	13	17.3	10	41.5	55	42	10
10	14.5	17.3	11	41.5	55	46	10
11	16	17.2	12	41.5	55	51	10
12	16.8	17.2	13	41.5	55	52	10
13	18	17	14	41.5	55	53	10
14	20	18	16	41.5	55	60	10
15	21	20	16	40.5	55	74	10
16	22	20	17	40.5	55	76	10
17	23.5	22	18	40.5	55	93	10
18	24.5	23	19	39.5	55	98	10
19	25	24	20	39.5	55	98	10
20	26	25	21	49.5	65	126	10
21	27	26	22	49.5	65	126	10
22	29	28	23	48.5	65	163	10
23	30	29	24	48.5	65	168	10
24	31	30	25	47.5	65	191	10
25	33	30	26	47.5	65	199	10
26	34	31	27	47.5	65	209	10
27	35	32.5	28	47.5	65	218	10

3300A 3305A (inch)	D ₁ (mm)	D ₂ (mm)	H ₁ (mm)	H ₂ (mm)	L (mm)	(g)	(pcs.)
7/32	8.9	17.3	6	41.5	55	35	10
1/4	9.9	17.3	7	41.5	55	37	10
5/16	12	17.3	9	41.5	55	40	10
11/32	12.3	17.3	10	41.5	55	41	10
3/8	14	17.3	11	41.5	55	46	10
7/16	16	17.2	12	41.5	55	51	10
1/2	18	17	14	41.5	55	53	10
9/16	20	18	16	41.5	55	60	10
19/32	21	20	16	40.5	55	74	10
5/8	22	20	17	40.5	55	76	10
11/16	23.5	22	18	40.5	55	93	10
3/4	25	24	20	39.5	55	98	10
13/16	27	26	22	49.5	65	126	10
7/8	29	28	23	48.5	65	163	10
15/16	31	30	25	47.5	65	191	10

RS3300M/12	12 Pieces Set/Rail 300mm	(g)
8, 9, 10, 11, 12, 13, 14, 15, 16, 17, 18, 19		878

RS3305M/12	12 Pieces Set/Rail 300mm	(g)
8, 9, 10, 11, 12, 13, 14, 15, 16, 17, 18, 19		878

RS3300A/9	9 Pieces Set/Rail 200mm	(g)
1/4, 5/16, 3/8, 7/16, 1/2, 9/16, 5/8, 11/16, 3/4		628

RS3305A/9	9 Pieces Set/Rail 200mm	(g)
1/4, 5/16, 3/8, 7/16, 1/2, 9/16, 5/8, 11/16, 3/4		628

3300M / 3300A

6-point Deep Sockets
6-kant-Steckschlüssel,lang
Douilles longues 6-pans

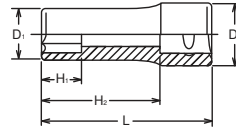

3305M / 3305A

12-point Deep Sockets
12-kant Steckschlüssel,lang
Douilles longues, 12-pans

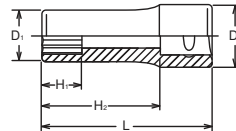

RS3300M/12

Socket Set on Rail
Steckschlüsselsatz auf Schiene
Jeu de douilles sur rail

RS3305M/12



RS3300A/9

Socket Set on Rail
Steckschlüsselsatz auf Schiene
Jeu de douilles sur rail

RS3305A/9



Hand Sockets Hand Steckschlüssel Douilles à main

3/8"

Z-SERIES
HAND
TITANIUM
SCREWDRIVERS
ACCESSORIES
IMPACT
SLEEVE-DRIVE
PROTECTOR
INDUSTRIAL
AUTOMOTIVE
MOTORCYCLE
CONSTRUCTION
SPARE PART

3310M

Surface Drive Deep Sockets
Surface Drive Steckschlüssel, lang
Douilles longues, Surface Drive

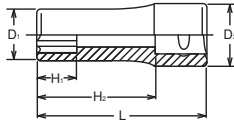

3310M (mm)	D ₁ (mm)	D ₂ (mm)	H ₁ (mm)	H ₂ (mm)	L (mm)	(g)	(pcs.)
6	9.9	17.3	7	41.5	55	37	10
7	10.6	17.3	8	41.5	55	37	10
8	12	17.3	9	41.5	55	40	10
9	13	17.3	10	41.5	55	42	10
10	14.5	17.3	11	41.5	55	46	10
11	16	17.2	12	41.5	55	51	10
12	16.8	17.2	13	41.5	55	52	10
13	18	17	14	41.5	55	53	10
14	20	18	16	41.5	55	60	10
15	21	20	16	40.5	55	74	10
16	22	20	17	40.5	55	76	10
17	23.5	22	18	40.5	55	93	10
18	24.5	23	19	39.5	55	98	10
19	25	24	20	39.5	55	98	10
20	26	25	21	49.5	65	126	10
21	27	26	22	49.5	65	126	10
22	29	28	23	48.5	65	163	10
23	30	29	24	48.5	65	168	10
24	31	30	25	47.5	65	161	10

RS3310M/12

Socket Set on Rail
Steckschlüsselsatz auf Schiene
Jeu de douilles sur rail



RS3310M/12	12 Pieces Set/Rail 300mm	(g)
8, 9, 10, 11, 12, 13, 14, 15, 16, 17, 18, 19		881

3300W

6-point Deep Whitworth Sockets
6-kant Steckschlüssel, lang, Whitworth
Douilles longues à 6-pans Whitworth

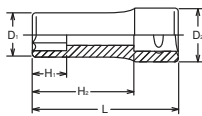

3300W 3305W (W)	D ₁ (mm)	D ₂ (mm)	H ₁ (mm)	H ₂ (mm)	L (mm)	(g)	(pcs.)
1/8	12.3	17.3	10	41.5	55	46	10
3/16	16	17.3	12	41.5	55	55	10
1/4	18	17	14	41.5	55	57	10
5/16	21	20	16	40.5	55	79	10
3/8	24.5	23	19	39.5	55	96	10
7/16	27	26	22	49.5	65	140	10
1/2	30	29	24	48.5	65	193	10
9/16	34	31	27	47.5	65	250	10

3305W

12-point Deep Whitworth Sockets
12-kant Steckschlüssel, Whitworth
Douilles longues à 12-pans Whitworth

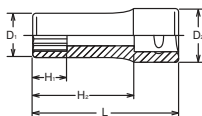

RS3300W/7 RS3305W/7

Socket Set on Rail
Steckschlüsselsatz auf Schiene
Jeu de douilles sur rail



RS3300W/7	7 Pieces Set/Rail 200mm	(g)
1/8, 3/16, 1/4, 5/16, 3/8, 7/16, 1/2		719

RS3305W/7	7 Pieces Set/Rail 200mm	(g)
1/8, 3/16, 1/4, 5/16, 3/8, 7/16, 1/2		719

BS W



BS-W	BS	3/16BS	1/4BS	5/16BS	3/8BS	7/16BS	1/2BS	9/16BS	5/8BS	11/16BS	3/4BS	7/8BS
	W	1/8W	3/16W	1/4W	5/16W	3/8W	7/16W	1/2W	9/16W	5/8W	11/16W	3/4W
S	(ref. mm)	8.64	11.30	13.34	15.24	18.03	20.83	23.37	25.65	27.94	30.48	33.35

3325 (E)	D ₁ (mm)	D ₂ (mm)	H ₁ (mm)	H ₂ (mm)	L (mm)	(g)	(pcs.)
E 4	5.6	17.3	4.6	41.5	55	29	10
E 5	6.9	17.3	5.2	41.5	55	31	10
E 6	7.9	17.3	5.4	41.5	55	33	10
E 7	8.9	17.3	6.6	41.5	55	36	10
E 8	9.9	17.3	7	41.5	55	39	10
E10	11.8	17.3	8.2	41.5	55	43	10
E12	14.5	17.2	9.3	41.5	55	53	10
E14	15.7	17.2	10.6	41.5	55	57	10
E16	18	17	11.8	41.5	55	69	10

RS3325/9	9 Pieces Set/Rail 200mm	(g)
E4, E5, E6, E7, E8, E10, E12, E14, E16		420

3325 TORX® Deep Sockets TORX® Steckschlüssel, lang Douilles longues TORX®



RS3325/9 Socket Set on Rail Steckschlüsselsatz auf Schiene Jeu de douilles sur rail



TORX® (E)

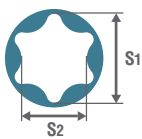

E	E4	E5	E6	E7	E8	E10	E11	E12	E14	E16	E18	E20	E22	E24	E26	E28	E30	E32
S ₁ (ref. mm)	3.7	4.6	5.6	6.1	7.4	9.3	9.9	11.0	12.8	14.6	16.5	18.3	20.1	22.0	23.7	25.5	27.3	29.0
S ₂ (ref. mm)	2.7	3.3	4.0	4.3	5.3	6.8	7.1	7.9	9.2	10.5	11.9	13.2	14.8	15.7	17.5	18.3	20.0	21.3

3350M (mm)	D ₁ (mm)	D ₂ (mm)	H ₁ (mm)	H ₂ (mm)	L (mm)	(g)	(pcs.)
8	12	17.4	5	41.5	55	50	10
10	14.5	17.4	6	41.5	55	54	10
12	16.8	17.2	7	41.5	55	58	10
13	18	17	8	41.5	55	59	10
14	19.5	18.5	8.5	41.5	55	71	10



3350M Nut Grip Deep Sockets **Nut Grip®** Steckschlüssel mit 2-facher Kugelhalterung, lang Douilles longues à billes de retenue



RS3350M/5 Socket Set on Rail Steckschlüsselsatz auf Schiene Jeu de douilles sur rail



RS3350M/5	5 Pieces set/Rail 150mm	(g)
8, 10, 12, 13, 14		322

3300FN (mm)	D ₁ (mm)	D ₂ (mm)	H (mm)	L (mm)	S (mm)	(g)	(pcs.)
8	14.5	17.3	6	53	6.4	38	10
9	16	17.3	7	53	6.8	41	10
10	16.8	17.2	7.5	53	7.2	42	10
11	18	17	8.5	53	8.3	42	10
12	20	18	9	53	8.8	50	10
13	21.1	20	9.5	62	9.4	66	10
14	22	20	10.5	62	10.5	66	10
15	23	22	11	70	11.5	82	10
16	24	23	11.5	70	12	90	10
17	25	24	12.5	80	13	110	10
18	27	25	13	80	13.5	120	10
19	28	26	14	80	14.5	130	10
22	32	29.5	16	80	16	180	10
24	34.5	31.5	17	80	17	200	10

3300FN Flare Nut Sockets Geschlitzte Steckschlüssel für Überwurfmuttern Douilles à tuyauter



RS3300FN/8 Socket Set on Rail Steckschlüsselsatz auf Schiene Jeu de douilles sur rail



RS3300FN/8	8 Pieces Set/Rail 200mm	(g)
9, 10, 11, 13, 14, 16, 17, 19		600

Z-SERIES
HAND
TITANIUM
SCREWDRIVERS ACCESSORIES
IMPACT
SLEEVE-DRIVE
PROTECTOR
INDUSTRIAL
AUTOMOTIVE
MOTORCYCLE
CONSTRUCTION
MOTORCYCLE
SPARE PART

3300M (L120)

6-point Extra Deep Sockets
6-kant Steckschlüssel,extra lang
Douilles extra longues 6-pans

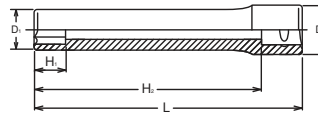

3300M-Size DEEP SOCKET

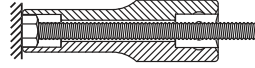

3300M-Size(L120) EXTRA DEEP SOCKET

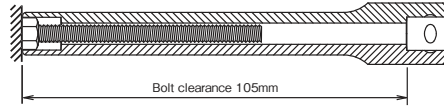

3305M (L120)

12-point Extra Deep Sockets
12-kant Steckschlüssel,extra lang
Douilles extra longues 12-pans



3300M(L120) 3305M(L120) (mm)	D ₁ (mm)	D ₂ (mm)	H ₁ (mm)	H ₂ (mm)	L (mm)	(g)	(pcs.)
8	12	17.3	9	106.5	120	85	10
10	14.5	17.3	11	106.5	120	110	10
12	16.8	17.2	13	106.5	120	116	10
13	18	17	14	106.5	120	155	5
14	20	18	16	106.5	120	166	5

3300M/4-L120 3305M/4-L120

Socket Set
Steckschlüssel Satz
Jeu de clés à douille



3300M/4-L120 4 Pieces Set/△=477g

PLASTIC BAG

Sockets

3300M(L120) 6-point Extra Deep Sockets
8, 10, 12, 14

3305M/4-L120 4 Pieces Set/△=477g

PLASTIC BAG

Sockets

3305M(L120) 12-point Extra Deep Sockets
8, 10, 12, 14

3350M (L120)

Nut Grip Deep Sockets **Nut Grip**[®]
Steckschlüssel mit 2-facher Kugelhalterung, lang
Douilles à billes de retenue

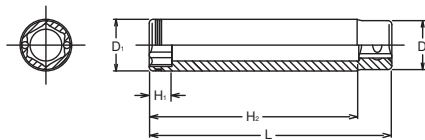

3350M(L120) (mm)	D ₁ (mm)	D ₂ (mm)	H ₁ (mm)	H ₂ (mm)	L (mm)	(g)	(pcs.)
10	14.5	17.2	6	106.5	120	110	10
12	16.8	17.2	7	106.5	120	116	10



NUT GRIP[®]

3350M/2-L120

Socket Set
Steckschlüssel Satz
Jeu de clés à douille



3350M/2-L120 2 Pieces Set/△=230g

PLASTIC BAG

Sockets

3350M(L120) Nut Grip Extra Deep Sockets
10, 12

3440M 3445M (mm)	D ₁ (mm)	D ₂ (mm)	H (mm)	L (mm)	(g)	(pcs.)
8	12	19	7.3	47	50	10
9	13.3	19	7.8	47.5	50	10
10	14.5	19	8.8	48.5	64	10
11	15.8	19	9.8	49.5	66	10
12	17	19	10.3	50	67	10
13	18.3	19	11.3	51	68	10
14	19.5	19	11.3	51	69	10
15	20.8	19	12.8	53.5	70	10
16	22	19	12.8	53.5	77	10
17	23.3	19	13.8	54.5	80	10
18	24.5	19	13.8	54.5	80	10
19	25.8	19	15.8	56.5	84	10
21	28.3	19	16.8	56.5	96	10

3440M / 3440A

6-point Universal Sockets
6-kant Gelenk-Einsätze
Douilles articulées, 6-pans

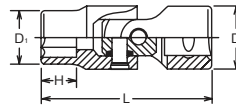

3440A 3445A (inch)	D ₁ (mm)	D ₂ (mm)	H (mm)	L (mm)	(g)	(pcs.)
5/16	12	19	7.3	47	50	10
3/8	14	19	8.3	48	64	10
7/16	15.8	19	9.8	49.5	66	10
1/2	18.3	19	11.3	51	68	10
9/16	19.5	19	11.3	51	69	10
5/8	22	19	12.8	53.5	77	10
11/16	24.5	19	13.8	54.5	80	10
3/4	25.8	19	15.8	56.5	84	10

3445M / 3445A

12-point Universal Sockets
12-kant Gelenk-Einsätze
Douilles articulées, 12-pans

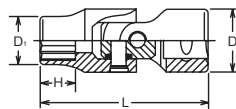

RS3440M/8	8 Pieces Set/Rail 200mm	(g)
8, 10, 11, 12, 13, 14, 17, 19		550

RS3440A/8	8 Pieces Set/Rail 200mm	(g)
5/16, 3/8, 7/16, 1/2, 9/16, 5/8, 11/16, 3/4		570

RS3440M/8 RS3440A/8

Socket Set on Rail
Steckschlüsselsatz auf Schiene
Jeu de douilles sur rail



3445W (W)	D ₁ (mm)	D ₂ (mm)	H (mm)	L (mm)	(g)	(pcs.)
1/8	13.3	19	7.8	47.5	50	10
3/16	15.8	19	9.7	49.5	66	10
1/4	18.3	19	11.3	51	68	10
5/16	20.8	19	12.8	53.5	70	10
3/8	24.5	19	13.8	54.5	80	10
7/16	28.3	19	16.8	57.5	96	10
1/2	30.8	19	17.8	58.5	105	10

3445W

12-Point Whitworth Universal Socket
12-kant Gelenk-Einsatz, Whitworth
Douille articulées, 12-pans, Whitworth

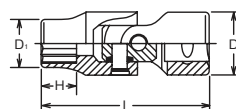

RS3445W/7	7 Pieces Set/Rail 200mm	(g)
1/8, 3/16, 1/4, 5/16, 3/8, 7/16, 1/2		570

RS3445W/7

Socket Set on Rail
Steckschlüsselsatz auf Schiene
Jeu de douilles sur rail



Z-SERIES
HAND
TITANIUM
ACCESSORIES
SCREWDRIVERS
IMPACT
SLEEVE-DRIVE
PROTECTOR
INDUSTRIAL
AUTOMOTIVE
MOTORCYCLE
CONSTRUCTION
SPARE PART

3440T

 TORX® Universal Sockets
TORX® Gelenk-Einsätze
Douilles articulées TORX®

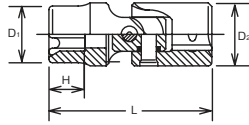

3440T (E)	D ₁ (mm)	D ₂ (mm)	H (mm)	L (mm)	(g)	(pcs.)
E 6	7.9	19	5.4	44.9	60	10
E 8	9.9	19	7	46.5	63	10
E10	11.8	19	8.2	47.7	63	10
E12	14.5	19	9.3	48.8	68	10
E14	15.7	19	10.6	50.1	68	10
E16	18	19	11.8	51.3	70	10
E18	19.5	19	13	53.5	78	10
E20	22	19	14.4	54.9	81	10

RS3440T/8

 Socket Set on Rail
Steckschlüsselsatz auf Schiene
Jeu de douilles sur rail



RS3440T/8	8 Pieces Set/Rail 200mm	(g)
E6, E8, E10, E12, E14, E16, E18, E20		594

3441M

 Nut Grip Universal Sockets **Nut Grip®**
Gelenk-Einsätze mit zweifacher Kugelhalterung
Douilles articulées, à billes de retenue

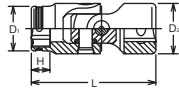

3441M (mm)	D ₁ (mm)	D ₂ (mm)	H (mm)	L (mm)	(g)	(pcs.)
8	12	19	5	46	57	10
10	14.5	19	6	46	58	10
12	16.8	19	7	47	58	10
13	18	19	8	48	60	10
14	19.5	19	8.5	49.5	65	10



RS3441M/5

 Socket Set on Rail
Steckschlüsselsatz auf Schiene
Jeu de douilles sur rail



RS3441M/5	5 Pieces Set/Rail 150mm	(g)
8, 10, 12, 13, 14		320

3340M-75

 Universal Deep Sockets
Gelenk-Steckschlüssel, lange Ausführung
Douilles articulées longues

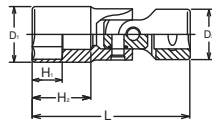

3340M-75 (mm)	D ₁ (mm)	D ₂ (mm)	H ₁ (mm)	H ₂ (mm)	L (mm)	(g)	(pcs.)
8	12	19	9	39	75	82	10
10	14.5	19	11	39	75	87	10
11	15.8	19	12	39	75	87	10
12	17	19	13	39	75	92	10
13	18.3	19	14	36	75	93	10
14	19.5	19	15	35	75	103	10
15	20.8	19	16	35	75	104	10
16	22	19	17	34	75	110	10
17	23.3	19	18	34	75	115	10
18	24.5	19	19	34	75	119	10
19	25.8	19	20	33	75	123	10

RS3340M/8-L75

 Socket Set on Rail
Steckschlüsselsatz auf Schiene
Jeu de douilles sur rail



RS3340M/8-L75	8 Pieces Set/Rail 200mm	(g)
8, 10, 11, 12, 13, 14, 17, 19		810

3430M (mm)	D (mm)	H (mm)	L (mm)	(g)	(pcs.)
5	19	15.5	62	66	10
6	19	15.5	62	70	10
7	19	15.5	62	72	10
8	19	15.5	62	74	10
10	19	15.5	62	78	10
12	19	15.5	62	85	10

3430M Universal Hex Sockets Gelenk-Einsätze für Schrauben mit Innensechskant Douilles articulées, 6-pans mâle

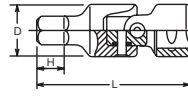

RS3430M/6	6 Pieces Set/Rail 150mm	(g)
5, 6, 7, 8, 10, 12		470

RS3430M/6 Socket Set on Rail Steckschlüsselsatz auf Schiene Jeu de douilles sur rail



3117M-125 / -250 Extended Sockets Schaftsteckschlüssel Douilles rallongées

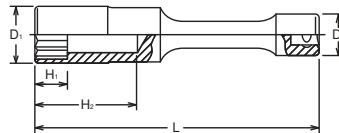

3117M-125 (mm)	D ₁ (mm)	D ₂ (mm)	H ₁ (mm)	H ₂ (mm)	L (mm)	(g)	(pce.)
10	14.5	18	10	44	125	121	1
11	16	18	11	44	125	133	1
12	17	18	12	44	125	133	1
13	18	18	13	44	125	134	1
14	19.5	18	14	44	125	145	1
17	23.5	18	17	44	125	178	1
19	25	18	19	44	125	187	1
21	27	18	21	44	125	195	1
22	29	18	22	44	125	214	1



3117M-250 (mm)	D ₁ (mm)	D ₂ (mm)	H ₁ (mm)	H ₂ (mm)	L (mm)	(g)	(pce.)
10	14.5	18	10	44	250	233	1
11	16	18	11	44	250	241	1
12	17	18	12	44	250	246	1
13	18	18	13	44	250	249	1
14	19.5	18	14	44	250	262	1
17	23.5	18	17	44	250	289	1
19	25	18	19	44	250	298	1
21	27	18	21	44	250	302	1
22	29	18	22	44	250	325	1

Z-SERIES
HAND
TITANIUM
SCREWDRIVERS ACCESSORIES
IMPACT
SLEEVE-DRIVE
PROTECTOR
INDUSTRIAL
AUTOMOTIVE
MOTORCYCLE
CONSTRUCTION
SPARE PART

3000-60 (PH)

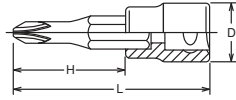
 PH Bit Sockets
Steckschlüssel für Kreuzschlitzschrauben, PH
Douilles tournevis pour vis à empreinte PH



3000 (PH)	D (mm)	H (mm)	L (mm)	 (g)	 (pcs.)
1	18	33.5	60	49	10
2	18	33.5	60	49	10
3	18	33.5	60	49	10
4	18	33.5	60	50	10

3000-50 (PZ)

 PZ Bit Sockets
Steckschlüssel für Kreuzschlitzschrauben, PZ
Douilles tournevis pour vis à empreinte PZ

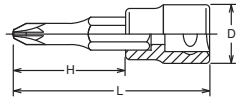







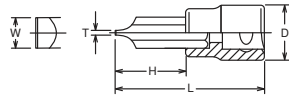







3000-50 (PZ)	D (mm)	H (mm)	L (mm)	 (g)	 (pcs.)
PZ1	18	23.5	50	50	10
PZ2	18	23.5	50	50	10
PZ3	18	23.5	50	50	10

3005-60

 Bit Sockets for Slotted Heads
Steckschlüssel für Schlitzschrauben
Douilles tournevis pour vis à fente





3005	T×W (mm)	D (mm)	H (mm)	L (mm)	 (g)	 (pcs.)
5	1.0× 5.5	18	33.5	60	47	10
8	1.2× 8	18	33.5	60	49	10
10	1.6×10	20	33.5	60	85	10

	 PH	 PZ	 Slotted	 HEX	 HEX (ball point)	 Triple Square (XZN)	 TORX® (T)	 TORX® (TH)	 TORXPLUS® (IP)	 TORXPLUS® (IPR)	 Ribe-CV
1/4"	No.2000 series	No.2000(PZ) series	No.2005 series	No.2010M/A series	No.2011M series	No.2020 series	No.2025 series	No.2025(TH) series	No.2025(IP) series	No.2025(IPR) series	—
3/8"	No.3000 series	No.3000(PZ) series	No.3005 series	No.3010M/A No.3012M/A No.3015M series	No.3011M series	No.3020 series	No.3025 series	No.3025(TH) series	No.3025(IP) series	No.3025(IPR) series	No.3027 series
1/2"	No.4000 series	No.4000(PZ) series	No.4005 series	No.4010M/A No.4012M/A series	—	No.4020 series	No.4025 series	—	No.4025(IP) series	—	No.4027 series

3/8"

Hand Sockets
Hand Steckschlüssel
Douilles à main

3010M-38 / -62 / -100 / -160 3010A-50

 Inhex Bit Sockets
Steckschlüssel für Innensechskant-Schrauben
 Douilles tournevis pour vis 6-pans creux

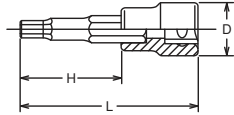

3010M-38 (mm)	D (mm)	H (mm)	L (mm)	(g)	(pcs.)
3	18	11.5	38	27	10
4	18	11.5	38	28	10
5	18	11.5	38	30	10
6	18	11.5	38	31	10
7	18	11.5	38	32	10
8	18	11.5	38	33	10
9	20	11.5	38	47	10
10	20	11.5	38	48	10
11	20	11.5	38	59	10
12	20	11.5	38	60	10
13	22	11.5	38	76	5
14	22	11.5	38	78	5

3010M-100 (mm)	D (mm)	H (mm)	L (mm)	(g)	(pcs.)
3	18	73.5	100	58	10
4	18	73.5	100	60	10
5	18	73.5	100	63	10
6	18	73.5	100	64	10
7	18	73.5	100	66	10
8	18	73.5	100	69	10
9	20	73.5	100	100	10
10	20	73.5	100	102	10
11	20	73.5	100	129	10
12	20	73.5	100	131	10
13	22	73.5	100	158	5
14	22	73.5	100	160	5

3010M-62 (mm)	D (mm)	H (mm)	L (mm)	(g)	(pcs.)
3	18	35.5	62	43	10
4	18	35.5	62	45	10
5	18	35.5	62	48	10
6	18	35.5	62	49	10
7	18	35.5	62	50	10
8	18	35.5	62	62	10
9	20	35.5	62	75	10
10	20	35.5	62	76	10
11	20	35.5	62	92	10
12	20	35.5	62	94	10
13	22	35.5	62	107	5
14	22	35.5	62	109	5

3010M-160 (mm)	D (mm)	H (mm)	L (mm)	(g)	(pcs.)
3	18	133.5	160	84	10
4	18	133.5	160	86	10
5	18	133.5	160	89	10
6	18	133.5	160	90	10
7	18	133.5	160	92	10
8	18	133.5	160	95	10
9	20	133.5	160	125	10
10	20	133.5	160	128	10
11	20	133.5	160	153	10
12	20	133.5	160	157	10
13	22	133.5	160	237	5
14	22	133.5	160	239	5

3010A-50 (inch)	D (mm)	H (mm)	L (mm)	(g)	(pcs.)
1/8	18	23.5	50	35	10
5/32	18	23.5	50	36	10
3/16	18	23.5	50	36	10
7/32	18	23.5	50	38	10
1/4	18	23.5	50	40	10
9/32	18	23.5	50	42	10
5/16	18	23.5	50	44	10
11/32	20	23.5	50	59	10
3/8	20	23.5	50	60	10
7/16	20	23.5	50	74	10
1/2	22	23.5	50	91	5

RS3010M/8-L38	8 Pieces Set/Rail 200mm	(g)
3, 4, 5, 6, 7, 8, 10, 12		322
RS3010M/8-L62	8 Pieces Set/Rail 200mm	(g)
3, 4, 5, 6, 7, 8, 10, 12		490
RS3010M/8-L100	8 Pieces Set/Rail 200mm	(g)
3, 4, 5, 6, 7, 8, 10, 12		645
RS3010A/8-L50	8 Pieces Set/Rail 200mm	(g)
1/8, 5/32, 3/16, 7/32, 1/4, 5/16, 3/8, 1/2		400

RS3010M/8-L38



Socket Set on Rail
Steckschlüsselsatz auf Schiene
Jeu de douilles sur rail

RS3010M/8-L62



RS3010M/8-L100



RS3010A/8-L50



Hand Sockets Hand Steckschlüssel Douilles à main

3/8"

Z-SERIES
HAND
TITANIUM
ACCESSORIES
SCREWDRIVERS
IMPACT
SLEEVE-DRIVE
PROTECTOR
INDUSTRIAL
AUTOMOTIVE
MOTORCYCLE
CONSTRUCTION
SPARE PART

3012M-25



Inhex Sockets
Steckschlüssel für Innensechskant-Schrauben
Douilles tournevis pour vis 6-pans creux

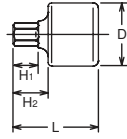

3012M-52 / -62 / -75 3012A-52 / -62 / -75



Inhex Sockets
Steckschlüssel für Innensechskant-Schrauben
Douilles tournevis pour vis 6-pans creux

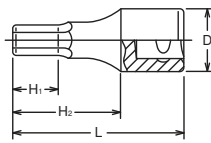

3012M-25 (mm)	D (mm)	H ₁ (mm)	H ₂ (mm)	L (mm)	(g)	(pcs.)
3	18.5	5.5	10	25	22	10
4	18.5	5.5	10	25	22	10
5	18.5	6.5	10	25	22	10
6	18.5	7.5	10	25	23	10
7	18.5	10	-	25	24	10
8	18.5	10	-	25	25	10
10	18.5	10	-	25	27	10
12	18.5	10	-	25	30	10
14	19	10	-	25	30	10
17	19	10	-	25	30	10

For Lubrication Service
Schmierdienst-Werkzeuge
Service lubrification-vidange



3012M/A are for hand use only.
Do not use with a power or impact wrench.
Bitte nicht auf Schlagschrauber oder anderen
Maschinen gebrauchen.
À ne pas utiliser sur des machines

3012M-52 (mm)	D (mm)	H ₁ (mm)	H ₂ (mm)	L (mm)	(g)	(pcs.)
3	18	10	34	52	35	10
4	18	15.5	34	52	38	10
5	18	15.5	34	52	40	10
6	18	15.5	34	52	42	10
7	18	15.5	34	52	46	10
8	18.5	15.5	34	52	50	10
9	18.5	15.5	34	52	55	10
10	20	15.5	34	52	66	10
11	20	15.5	34	52	72	10
12	20	15.5	34	52	77	10
13	20	15.5	34	52	82	10
14	20	15.5	34	52	89	10

3012M-62 (mm)	D (mm)	H ₁ (mm)	H ₂ (mm)	L (mm)	(g)	(pcs.)
3	18	10	44	62	38	10
4	18	15.5	44	62	40	10
5	18	15.5	44	62	43	10
6	18	15.5	44	62	46	10
7	18	15.5	44	62	53	10
8	18.5	15.5	44	62	58	10
9	18.5	15.5	44	62	63	10
10	20	15.5	44	62	77	10
11	20	15.5	44	62	83	10
12	20	15.5	44	62	90	10
13	20	15.5	44	62	95	10
14	20	15.5	44	62	109	10

3012M-75 (mm)	D (mm)	H ₁ (mm)	H ₂ (mm)	L (mm)	(g)	(pcs.)
3	18	10	57	75	41	10
4	18	15.5	57	75	43	10
5	18	15.5	57	75	48	10
6	18	15.5	57	75	53	10
7	18	15.5	57	75	58	10
8	18.5	15.5	57	75	72	10
9	18.5	15.5	57	75	92	10
10	20	15.5	57	75	114	10
11	20	15.5	57	75	120	10
12	20	15.5	57	75	127	10
13	20	15.5	57	75	132	10
14	20	15.5	57	75	146	10

3012A-52 (inch)	D (mm)	H ₁ (mm)	H ₂ (mm)	L (mm)	(g)	(pcs.)
1/8	18	10	34	52	35	10
5/32	18	15.5	34	52	38	10
3/16	18	15.5	34	52	40	10
7/32	18	15.5	34	52	42	10
1/4	18	15.5	34	52	44	10
9/32	18	15.5	34	52	46	10
5/16	18.5	15.5	34	52	50	10
11/32	18.5	15.5	34	52	55	10
3/8	20	15.5	34	52	65	10
7/16	20	15.5	34	52	72	10
1/2	20	15.5	34	52	82	10
9/16	20	15.5	34	52	89	10

3012A-62 (inch)	D (mm)	H ₁ (mm)	H ₂ (mm)	L (mm)	(g)	(pcs.)
1/8	18	10	44	62	38	10
5/32	18	15.5	44	62	40	10
3/16	18	15.5	44	62	43	10
7/32	18	15.5	44	62	46	10
1/4	18	15.5	44	62	48	10
9/32	18	15.5	44	62	53	10
5/16	18.5	15.5	44	62	58	10
11/32	18.5	15.5	44	62	63	10
3/8	20	15.5	44	62	73	10
7/16	20	15.5	44	62	83	10
1/2	20	15.5	44	62	95	10
9/16	20	15.5	44	62	109	10

3012A-75 (inch)	D (mm)	H ₁ (mm)	H ₂ (mm)	L (mm)	(g)	(pcs.)
1/8	18	10	57	75	41	10
5/32	18	15.5	57	75	43	10
3/16	18	15.5	57	75	48	10
7/32	18	15.5	57	75	53	10
1/4	18	15.5	57	75	58	10
9/32	18	15.5	57	75	72	10
5/16	18.5	15.5	57	75	92	10
11/32	18.5	15.5	57	75	114	10
3/8	20	15.5	57	75	120	10
7/16	20	15.5	57	75	127	10
1/2	20	15.5	57	75	132	10
9/16	20	15.5	57	75	146	10

RS3012M/8-L52



Socket Set on Rail
Steckschlüsselsatz auf Schiene
Jeu de douilles sur rail

RS3012A /8-L52



RS3012M/8-L52	8 Pieces Set/Rail 200mm	(g)
3, 4, 5, 6, 7, 8, 10, 12		394

RS3012A/8-L52	8 Pieces Set/Rail 200mm	(g)
1/8, 5/32, 3/16, 7/32, 1/4, 5/16, 3/8, 1/2		425

3011M-62 (mm)	D (mm)	H (mm)	L (mm)	(g)	(pcs.)
3	18	35.5	62	45	10
4	18	35.5	62	46	10
5	18	35.5	62	48	10
6	18	35.5	62	49	10
7	18	35.5	62	50	10
8	18	35.5	62	51	10
10	20	35.5	62	66	10
12	20	35.5	62	79	10

3011M-100 (mm)	D (mm)	H (mm)	L (mm)	(g)	(pcs.)
3	18	73.5	100	61	10
4	18	73.5	100	62	10
5	18	73.5	100	64	10
6	18	73.5	100	65	10
7	18	73.5	100	67	10
8	18	73.5	100	68	10
New 10	20	73.5	100	91	10

3011M-120 (mm)	D (mm)	H (mm)	L (mm)	(g)	(pcs.)
3	18	93.5	120	77	10
4	18	93.5	120	78	10
5	18	93.5	120	80	10
6	18	93.5	120	81	10
7	18	93.5	120	83	10
8	18	93.5	120	84	10

3011M-160 (mm)	D (mm)	H (mm)	L (mm)	(g)	(pcs.)
3	18	133.5	160	87	10
4	18	133.5	160	88	10
5	18	133.5	160	89	10
6	18	133.5	160	91	10
7	18	133.5	160	93	10
8	18	133.5	160	95	10

⚠ Ball point bit sockets have less strength due to the special design. Make sure to use them correctly.

3015M-62 (mm)	D (mm)	H (mm)	L (mm)	(g)	(pcs.)
3	18	35.5	62	43	10
4	18	35.5	62	45	10
5	18	35.5	62	50	10
6	18	35.5	62	50	10
7	18	35.5	62	50	10
8	18	35.5	62	62	10
10	20	35.5	62	75	10
12	20	35.5	62	95	10

3015M-100 (mm)	D (mm)	H (mm)	L (mm)	(g)	(pcs.)
3	18	73.5	100	60	10
4	18	73.5	100	60	10
5	18	73.5	100	65	10
6	18	73.5	100	65	10
7	18	73.5	100	70	10
8	18	73.5	100	70	10
10	20	73.5	100	105	10
12	20	73.5	100	135	10

Grip Ring holds hex screws

⚠ Grip Ring bit sockets have less strength due to the special design. Make sure to use them correctly.

RS3015M/8-L62	8 Pieces Set/Rail 200mm	(g)
3, 4, 5, 6, 7, 8, 10, 12		500

RS3015M/8-L100	8 Pieces Set/Rail 200mm	(g)
3, 4, 5, 6, 7, 8, 10, 12		650

3011M-62 / -100 / -120 / -160

⚠ Ballpoint Inhex Sockets
Steckschlüssel mit Kugelkopf, für Innensechskant-Schrauben
Douilles tournevis avec tête sphérique pour vis 6-pans creux

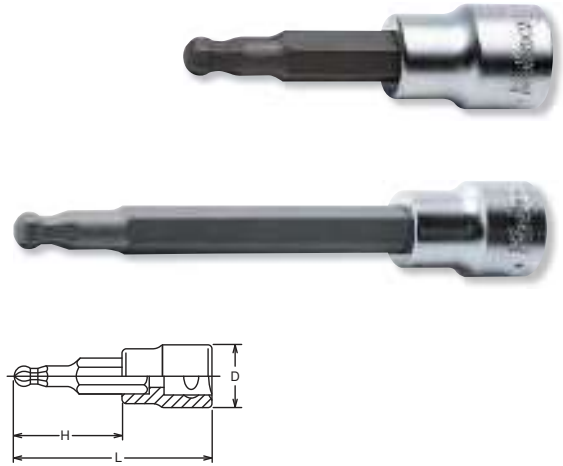

3015M-62 / -100

⚠ Inhex Bit Socket, Grip Ring
Steckschlüssel für Innensechskant-Schrauben
Douilles tournevis pour vis 6-pans creux

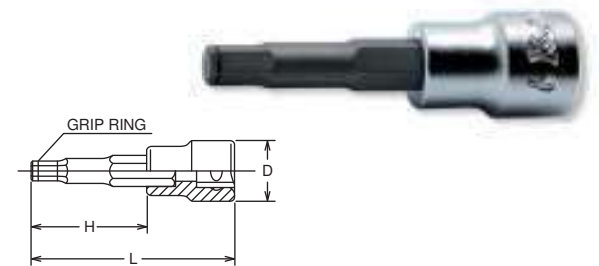

RS3015M/8-L62

RS3015M/8-L100

⚠ Socket Set on Rail
Steckschlüsselsatz auf Schiene
Jeu de douilles sur rail



3020-38 / -50 / -100 / -120



XZN Bit Sockets
Steckschlüssel für XZN Schrauben
Douilles tournevis pour empreinte XZN

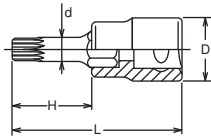

3020-38 (XZN)	D (mm)	d (mm)	H (mm)	L (mm)	(g)	(pcs.)
M 5	18	7.8	11.5	38	32	10
M 6	18	7.8	11.5	38	33	10
M 8	18	7.8	11.5	38	36	10
M10	20	11.9	11.5	38	51	10
M12	20	11.9	11.5	38	52	10
M14	22	13.9	11.5	38	74	10

3020-50 (XZN)	D (mm)	d (mm)	H (mm)	L (mm)	(g)	(pcs.)
M 4	18	7.8	23.5	50	35	10
M 5	18	7.8	23.5	50	37	10
M 6	18	7.8	23.5	50	39	10
M 8	18	7.8	23.5	50	40	10
M10	20	11.9	23.5	50	65	10
M12	20	11.9	23.5	50	69	10
M14	22	13.9	23.5	50	75	10

3020-100 (XZN)	D (mm)	d (mm)	H (mm)	L (mm)	(g)	(pcs.)
M 4	18	7.8	73.5	100	57	10
M 5	18	7.8	73.5	100	59	10
M 6	18	7.8	73.5	100	61	10
M 8	18	7.8	73.5	100	62	10
M10	20	11.9	73.5	100	99	10
M12	20	11.9	73.5	100	103	10
M14	22	13.9	73.5	100	145	5

3020-120 (XZN)	D (mm)	d (mm)	H (mm)	L (mm)	(g)	(pcs.)
M 4	18	7.8	93.5	120	77	10
M 5	18	7.8	93.5	120	79	10
M 6	18	7.8	93.5	120	81	10
M 8	18	7.8	93.5	120	82	10
M10	20	11.9	93.5	120	119	10
M12	20	11.9	93.5	120	123	10
M14	22	13.9	93.5	120	165	5

RS3020/6-L38



Socket Set on Rail
Steckschlüsselsatz auf Schiene
Jeu de douilles sur rail



RS3020/6-L38	6 Pieces Set/Rail 150mm	(g)
M5, M6, M8, M10, M12, M14		308

RS3020/7-L50



Socket Set on Rail
Steckschlüsselsatz auf Schiene
Jeu de douilles sur rail



RS3020/7-L50	7 Pieces Set/Rail 200mm	(g)
M4, M5, M6, M8, M10, M12, M14		400

XZN

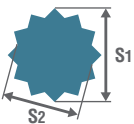

XZN		M4	M5	M6	M8	M10	M12	M14	M16	M18
S ₁	(ref. mm)	3.6	4.8	6.1	7.3	9.7	11.5	13.3	15.7	16.9
S ₂	(ref. mm)	3.1	4.1	5.1	6.1	8.1	9.7	11.2	13.2	14.2

3/8"

Hand Sockets
Hand Steckschlüssel
Douilles à main

3025-38 (T)	D (mm)	H (mm)	L (mm)	(g)	(pcs.)
T 8	18	11.5	38	32	10
T 9	18	11.5	38	32	10
T10	18	11.5	38	32	10
T15	18	11.5	38	33	10
T20	18	11.5	38	33	10
T25	18	11.5	38	33	10
T27	18	11.5	38	33	10
T30	18	11.5	38	33	10
T40	18	11.5	38	34	10
T45	18	11.5	38	37	10
T50	20	11.5	38	49	10
T55	20	11.5	38	57	10

3025-50 (T)	D (mm)	H (mm)	L (mm)	(g)	(pcs.)
T 8	18	23.5	50	36	10
T 9	18	23.5	50	36	10
T10	18	23.5	50	36	10
T15	18	23.5	50	36	10
T20	18	23.5	50	36	10
T25	18	23.5	50	37	10
T27	18	23.5	50	37	10
T30	18	23.5	50	38	10
T40	18	23.5	50	39	10
T45	18	23.5	50	41	10
T50	20	23.5	50	55	10
T55	20	23.5	50	67	10

RS3025/8-L38	8 Pieces Set/Rail 200mm	(g)
T10, T15, T20, T25, T27, T30, T40, T45		300

RS3025/8-L50	8 Pieces Set/Rail 200mm	(g)
T10, T15, T20, T25, T27, T30, T40, T45		320

3025-38 / -50 / -140 (T)

TORX® Bit Sockets
TORX® Bit-Steckschlüssel
Douilles tournevis, TORX®

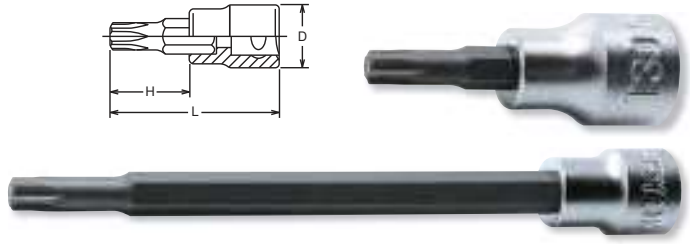

3025-140 (T)	D (mm)	H (mm)	L (mm)	(g)	(pcs.)
T 9	18	113.5	140	75	10
T10	18	113.5	140	75	10
T15	18	113.5	140	75	10
T20	18	113.5	140	75	10
T25	18	113.5	140	76	10
T27	18	113.5	140	76	10
T30	18	113.5	140	77	10
T40	18	113.5	140	78	10
T45	18	113.5	140	80	10
T50	20	113.5	140	94	10
T55	20	113.5	140	106	10

RS3025/8-L38 RS3025/8-L50

Socket Set on Rail
Steckschlüsselsatz auf Schiene
Jeu de douilles sur rail



TORX®
(T)

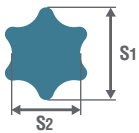

T	T8	T9	T10	T15	T20	T25	T27	T30	T40	T45	T50	T55	T60	T70	T80	T90	T100
S ₁ (ref. mm)	2.3	2.5	2.7	3.3	3.9	4.5	5.0	5.6	6.7	7.9	8.9	11.3	13.3	15.6	17.6	20.0	22.2
S ₂ (ref. mm)	1.7	1.8	2.0	2.3	2.8	3.2	3.6	4.0	4.8	5.6	6.2	8.0	9.5	11.1	12.7	14.2	15.8

3025-50	D (mm)	H (mm)	L (mm)	(g)	(pcs.)
T35	18	23.5	50	39	10

3025-100R (T)	D (mm)	d (mm)	H (mm)	L (mm)	(g)	(pcs.)
T20	18	4	73.5	100	38	10
T25	18	4.6	73.5	100	40	10
T27	18	5.2	73.5	100	42	10
T30	18	5.7	73.5	100	45	10
T40	18	6.8	73.5	100	52	10
T45	18	8	73.5	100	73	10
T50	20	9	73.5	100	80	10
T55	20	11.4	73.5	100	106	10

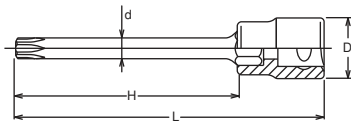

RS3025/8-L100R	8 Pieces Set/Rail 200mm	(g)
T20, T25, T27, T30, T40, T45, T50, T55		490

3025-50-T35

Bit Socket
Bit-Steckschlüssel
Douilles tournevis



3025-100R (T)

TORX® Bit Sockets, round-shaft
TORX® Bit-Steckschlüssel mit Rundschaft
Douilles tournevis TORX® avec manche ronde



RS3025/8-L100R

Socket Set on Rail
Steckschlüsselsatz auf Schiene
Jeu de douilles sur rail



Z-SERIES
HAND
TITANIUM
SCREWDRIVERS ACCESSORIES
IMPACT
SLEEVE-DRIVE
PROTECTOR
INDUSTRIAL
AUTOMOTIVE
CONSTRUCTION MOTORCYCLE
SPARE PART

3025-50 / -160 (TH)

 Tamper Resistant TORX® Bit Sockets
Tamper Resistant TORX® Bit-Steckschlüssel
Douilles tournevis, Tamper-Resistant TORX®



 Tamper Resistant TORX® Bit Sockets have less strength due to special design. Make sure to use it correctly.



Bitte beachten Sie die geringere Belastbarkeit der Tamper Resistant Torx Steckschlüssel.

Veuillez respecter la moindre capacité inférieure de charge des douilles Tamper Resistant Torx.

3025-50 (TH)	D (mm)	H (mm)	L (mm)	(g)	(pcs.)
T10H	18	23.5	50	37	10
T15H	18	23.5	50	38	10
T20H	18	23.5	50	38	10
T25H	18	23.5	50	38	10
T27H	18	23.5	50	38	10
T30H	18	23.5	50	39	10
T40H	18	23.5	50	40	10
T45H	18	23.5	50	41	10
T50H	20	23.5	50	61	10
T55H	20	23.5	50	61	10

3025-160 (TH)	D (mm)	H (mm)	L (mm)	(g)	(pcs.)
T25H	18	133.5	160	83	10
T27H	18	133.5	160	83	10
T30H	18	133.5	160	84	10
T40H	18	133.5	160	85	10
T45H	18	133.5	160	86	10
T50H	20	133.5	160	128	10
T55H	20	133.5	160	128	10

RS3025/9-HOLE

  Socket Set on Rail
Steckschlüsselsatz auf Schiene
Jeu de douilles sur rail



RS3025/9-HOLE	9 Pieces Set/Rail 200mm	(g)
T10H, T15H, T20H, T25H, T27H, T30H, T40H, T45H, T50H		405

3247

 Bit Socket Set
Schraubendreher-Steckschlüssel Satz
Jeu de douilles de vissage



3247	4 Pieces Set/ =385g
PLASTIC BAG	
Sockets	
 3025.160 Tamper-Resistant TORX® Bit Sockets	T27H, T30H, T40H, T50H

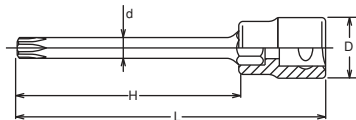

3025-100R (TH)

 Tamper-Resistant TORX® Bit Sockets, round-shaft
Tamper-Resistant TORX® Bit-Steckschlüssel mit Rundschaft
Douilles tournevis, Tamper-Resistant TORX® avec manche ronde



3025-100R (TH)	D (mm)	d (mm)	H (mm)	L (mm)	(g)	(pcs.)
T20H	18	4	73.5	100	38	10
T25H	18	4.6	73.5	100	40	10
T27H	18	5.2	73.5	100	42	10
T30H	18	5.7	73.5	100	45	10
T40H	18	6.8	73.5	100	52	10
T45H	18	8	73.5	100	73	10
T50H	20	9	73.5	100	80	10
T55H	20	11.4	73.5	100	106	10

RS3025/8-L100RH

  Socket Set on Rail
Steckschlüsselsatz auf Schiene
Jeu de douilles sur rail



RS3025/8-L100RH	8 Pieces Set/Rail 200mm	(g)
T20H, T25H, T27H, T30H, T40H, T45H, T50H, T55H		490

3025-50 (IP)	D (mm)	H (mm)	L (mm)	(g)	(pcs.)
10IP	18	23.5	50	38	10
15IP	18	23.5	50	38	10
20IP	18	23.5	50	38	10
25IP	18	23.5	50	38	10
27IP	18	23.5	50	40	10
30IP	18	23.5	50	40	10
40IP	18	23.5	50	41	10
45IP	18	23.5	50	41	10
50IP	20	23.5	50	61	10
55IP	20	23.5	50	61	10

RS3025/8-IP	8 Pieces Set/Rail 200mm	(g)
20IP, 25IP, 27IP, 30IP, 40IP, 45IP, 50IP, 55IP		370

RSX025/11-IP	11 Pieces Set/Rail 200mm	(g)
2025.28(IP)	10IP, 15IP, 20IP, 25IP, 27IP	480
3025.50(IP)	30IP, 40IP, 45IP, 50IP	
4025.60(IP)	55IP, 60IP	

$$\boxed{1/4"} + \boxed{3/8"} + \boxed{1/2"} = \text{Total Length}$$

TORXPLUS® (IP)

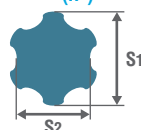

IP	8IP	9IP	10IP	15IP	20IP	25IP	27IP	30IP	40IP	45IP	50IP	55IP	60IP	70IP
S ₁ (ref. mm)	2.3	2.5	2.7	3.3	3.9	4.5	5.0	5.6	6.7	7.9	8.9	11.3	13.3	15.6
S ₂ (ref. mm)	1.7	1.8	2.0	2.3	2.8	3.2	3.6	4.0	4.8	5.6	6.2	8.0	9.5	11.1

3025-50 (IP)



TORXPLUS® Bit Sockets
TORXPLUS® Bit-Steckschlüssel
Douilles tournevis, TORXPLUS®

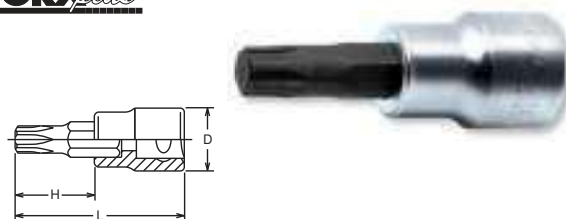

RS3025/8-IP



Socket Set on Rail
Steckschlüsselsatz auf Schiene
Jeu de douilles sur rail



RSX025/11-IP



Socket Set on Rail
Steckschlüsselsatz auf Schiene
Jeu de douilles sur rail



TORXplus®

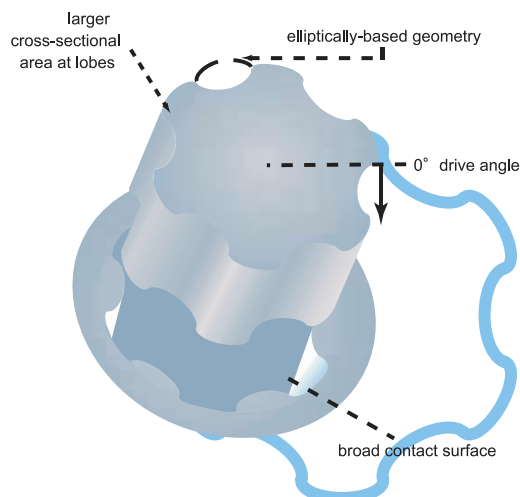
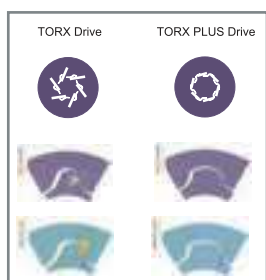
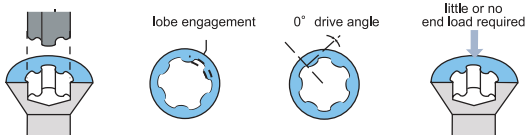

Z-SERIES
HAND
TITANIUM
SCREWDRIVERS ACCESSORIES
IMPACT
SLEEVE-DRIVE
PROTECTOR
INDUSTRIAL
AUTOMOTIVE
CONSTRUCTION MOTORCYCLE
SPARE PART

3025-50 (IPR)



Tamper-Resistant TORXPLUS® Bit Sockets
Tamper-Resistant TORXPLUS® Bit-Steckschlüssel
Douilles tournevis TORXPLUS® avec trou

TORXplus®



3025-50 (IPR)	D (mm)	H (mm)	L (mm)	(g)	(pcs.)
10IPR	18	23.5	50	38	10
15IPR	18	23.5	50	38	10
20IPR	18	23.5	50	38	10
25IPR	18	23.5	50	38	10
27IPR	18	23.5	50	40	10
30IPR	18	23.5	50	40	10
40IPR	18	23.5	50	41	10
45IPR	18	23.5	50	41	10
50IPR	20	23.5	50	61	10
55IPR	20	23.5	50	61	10

RS3025/9-IPR



Socket Set on Rail
Steckschlüsselsatz auf Schiene
Jeu de douilles sur rail



RS3025/9-IPR	9 Pieces Set/Rail 200mm	(g)
10IPR, 15IPR, 20IPR, 25IPR, 27IPR, 30IPR, 40IPR, 45IPR, 50IPR		395

RSX025/11-IPR



Socket Set on Rail
Steckschlüsselsatz auf Schiene
Jeu de douilles sur rail



RSX025/11-IPR	11 Pieces Set/Rail 200mm	(g)
2025.28(IPR)	8IPR, 10IPR, 15IPR, 20IPR, 25IPR, 27IPR, 30IPR	320
3025.50(IPR)	40IPR, 45IPR, 50IPR, 55IPR	

1/4" + 3/8"

TORXPLUS® (IPR)

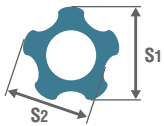

IPR	8IPR	9IPR	10IPR	15IPR	20IPR	25IPR	27IPR	30IPR	40IPR	45IPR	50IPR	55IPR
S ₁ (ref. mm)	2.2	2.4	2.6	3.1	3.6	4.1	4.7	5.2	6.3	7.4	8.4	10.6
S ₂ (ref. mm)	2.0	2.2	2.4	2.8	3.3	3.8	4.3	4.8	5.7	6.7	7.6	9.7

3027-50 / -100



Bit Sockets for Ribe Screws
Steckschlüsselklingen für Ribe Schrauben
Douilles tournevis pour écrous profil Ribe



3027-50	D (mm)	H (mm)	L (mm)	(g)	(pcs.)
M 5	18	23.5	50	38	10
M 6	18	23.5	50	38	10
M 7	18	23.5	50	38	10
M 8	18	23.5	50	39	10
M 9	20	23.5	50	40	10
M10	20	23.5	50	40	10
M12	20	23.5	50	41	10

3027-100	D (mm)	H (mm)	L (mm)	(g)	(pcs.)
M 5	18	73.5	100	40	10
M 6	18	73.5	100	42	10
M 8	18	73.5	100	45	10
M10	20	73.5	100	52	10
M12	20	73.5	100	73	10

RS3027/5-L50



Socket Set on Rail
Steckschlüsselsatz auf Schiene
Jeu de douilles sur rail



RS3027/5-L50	5 Pieces Set/Rail 150mm	(g)
M5, M6, M8, M10, M12		240

Ribe CV

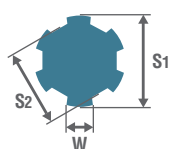

CV	M5	M6	M7	M8	M9	M10	M12	M13	M14	M16
W (ref. mm)	1.2	1.3	1.4	1.8	2.0	2.3	2.6	3.1	3.2	3.6
S ₁ (ref. mm)	5.0	6.0	7.0	8.0	9.0	10.0	12.0	13.0	14.0	16.0
S ₂ (ref. mm)	3.8	4.5	5.0	6.0	7.1	7.4	9.0	11.0	10.4	11.9

3110M (mm)	D (mm)	H (mm)	L (mm)	(g)	(pcs.)
6	18	10	28	30	10
8	18	10	28	30	10
10	18	10	28	33	10
12	18	10	28	37	10

3110A (inch)	D (mm)	H (mm)	L (mm)	(g)	(pcs.)
5/16	18	10	28	30	10
3/8	18	10	28	33	10
1/2	18	10	28	37	10

3110M / 3110A

4-point Male Sockets
Öldienst-Steckschlüssel
Douilles mâles 4-pans

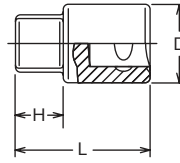

3119 (mm)	T ₁ ×T ₂ (mm)	D ₁ (mm)	D ₂ (mm)	d (mm)	L (mm)	(g)	(pcs.)
3 x 5	3 x 5	17	17.3	11	30	30	10
5.5×6	5.5×6	21	19.5	14	33	45	10



For Wing Bolt
Für Flügelschrauben
Pour écrous à oreilles

For Drain Plug in Radiator
Für Kühler-Ablasschrauben
Pour le vidange du radiateur

3119

Wing Bolt Socket
Steckschlüssel für Flügelschrauben
Douilles pour écrous à oreilles

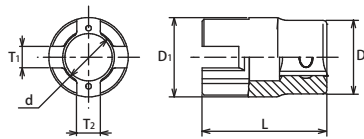

3137	D ₁ (mm)	D ₂ (mm)	L (mm)	(g)	(pcs.)
3137	13	16.5	30	30	10

For DIN3126 C6.3 Bits
Für DIN3126 C6.3 Bits
Pour DIN3126 C6.3 Embouts

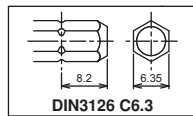

3137

Bit Holder
Klingenhalter
Porte-embouts

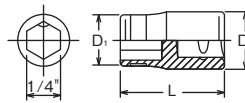

3138	D ₁ (mm)	D ₂ (mm)	L (mm)	(g)	(pcs.)
3138	16	18	38	55	10

For DIN3126 C8 Bits
Für DIN3126 C8 Bits
Pour DIN3126 C8 Embouts

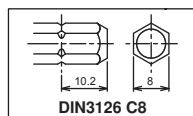

3138

Bit Holder
Klingenhalter
Porte-embouts

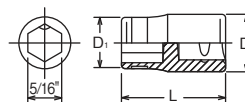

Z-SERIES
HAND
TITANIUM
SCREWDRIVERS ACCESSORIES
IMPACT
SLEEVE-DRIVE
PROTECTOR
INDUSTRIAL
AUTOMOTIVE
MOTORCYCLE
CONSTRUCTION
SPARE PART

2749PS-3/8

Reversible Ratchet (Short)
Knarre kurz, verstellbar
Cliquet courte, réversible



* Renewal Kits → 2749RK-3/8 → P306

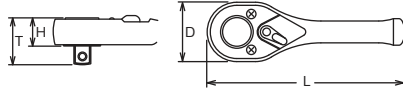

	D (mm)	T (mm)	H (mm)	L (mm)	(g)	(pcs.)
2749PS-3/8	25	21.9	11.2	75	70	10

2749P-3/8

Reversible Ratchet
Knarre, verstellbar
Cliquet, réversible



* Renewal Kits → 2749RK-3/8 → P306

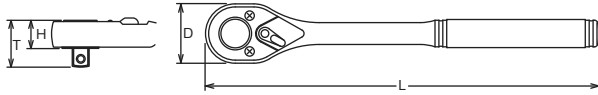

	D (mm)	T (mm)	H (mm)	L (mm)	(g)	(pcs.)
2749P-3/8	25	21.9	11.2	125	101	1

⚠ 2749-3/8 series have less strength compared with normal [38] ratchet due to the technical design. Make sure to use the ratchet correctly.

3749S

Reversible Ratchet (Short)
Knarre kurz, verstellbar
Cliquet courte, réversible



* Renewal Kits → 3749RK → P306



3749SB

Reversible Ratchet with quick release button
Knarre, verstellbar mit Entriegelungsknopf
Cliquet, réversible avec bouton de débrayage



* Renewal Kits → 3749BRK → P306

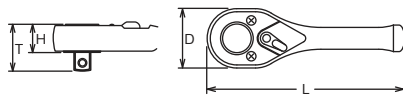

	D (mm)	T (mm)	H (mm)	L (mm)	(g)	(pcs.)
3749S	34	24.8	14.1	110	183	5
3749SB	34	24.8	14.1	110	183	5

⚠ Reversible Ratchet with quick release button has less strength compared with normal ratchet due to the technical design. Make sure to use the ratchet correctly.

3753SM

Multi Purpose Ratchet, reversible
Knarre mit 2 Vierkantöffnungen, umstellbar
Cliquet réversible deux carrés femelles, réversibles



* Renewal Kits → 3753RK → P306

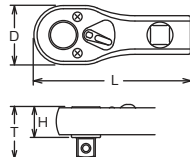

	D (mm)	T (mm)	H (mm)	L (mm)	(g)	(pcs.)
3753SM	30.5	26.4	15.7	81	175	5

3753SMB

Multi Purpose Ratchet, reversible, with quick release button
Knarre mit 2 Vierkantöffnungen, mit Entriegelungsknopf umstellbar
Cliquet réversible deux carrés, avec bouton de débrayage



* Renewal Kits → 3753BRK → P306

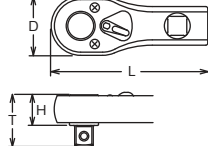

	D (mm)	T (mm)	H (mm)	L (mm)	(g)	(pcs.)
3753SMB	30.5	26.4	15.7	81	175	5



3/8"

Hand Sockets
Hand Steckschlüssel
Douilles à main

[L/R Marking]



* Renewal Kits → 3752RK → P307



* Renewal Kits → 3752RK → P307

A pointer and L/R markings on the ratchet head indicate the turning direction. The reduced diameter of the head allows easier access in tight spots.

Eine L/R Markierung auf dem Knarrenkopf zeigt die gerade eingestellte Drehrichtung an. Der geringe Kopfdurchmesser erleichtert das Arbeiten auch an schwer zugänglichen Stellen.

Un marquage L/R sur la tête de cliquet indique le sens de rotation. Le diamètre de tête réduit facilite le travail dans les endroits difficilement accessibles.

	D (mm)	T (mm)	H (mm)	L (mm)	(g)	(pce.)
3752J	33	34.3	23.9	200	310	1
3752N	33	34.3	23.9	200	310	1



3752J Reversible Ratchet
Knarre, verstellbar
Cliquet, réversible



3752N Reversible Ratchet
Knarre, verstellbar
Cliquet, réversible

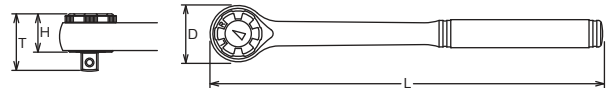

* Renewal Kits → 3753RK → P306



* Renewal Kits → 3753RK → P306



* Renewal Kits → 3753RK → P306



* Renewal Kits → 3753RK → P306

3753J Reversible Ratchet
Knarre, verstellbar
Cliquet, réversible



3753P Reversible Ratchet
Knarre, verstellbar
Cliquet, réversible



3753N Reversible Ratchet
Knarre, verstellbar
Cliquet, réversible



D3753J Reversible Ratchet
Knarre, verstellbar
Cliquet, réversible



	D (mm)	T (mm)	H (mm)	L (mm)	(g)	(pce.)
3753J	30.5	26.4	15.7	200	260	1
3753P	30.5	26.4	15.7	200	286	1
3753N	30.5	26.4	15.7	200	320	1
D3753J	30.5	26.4	15.7	200	260	1

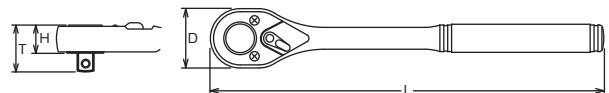

* Renewal Kits → 3753RK → P306

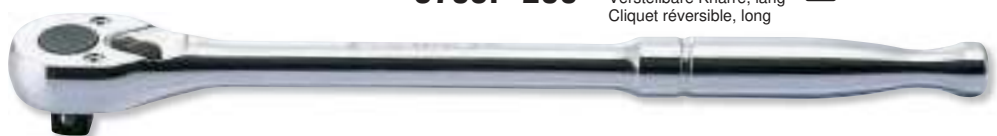

3753P-250 Reversible Ratchet (Long)
Verstellbare Knarre, lang ⚠️
Cliquet réversible, long

	D (mm)	T (mm)	H (mm)	L (mm)	(g)	(pce.)
3753P-250	30.5	26.4	15.7	250	335	1

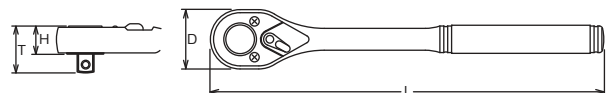

⚠️ 3753P-250 have longer handle than standard, and can be loaded to excessive torque value. In the interest of your own safety always apply load evenly and progressively to avoid breakage and possible injury.

Hand Sockets Hand Steckschlüssel **3/8"** Douilles à main

Z-SERIES
HAND
TITANIUM
SCREWDRIVERS ACCESSORIES
IMPACT
SLEEVE-DRIVE
PROTECTOR
INDUSTRIAL
AUTOMOTIVE
CONSTRUCTION MOTORCYCLE
SPARE PART

3753JB Reversible Ratchet with quick release button
Knarre, verstellbar mit Entriegelungsknopf
Cliquet, réversible avec bouton de débrayage



* Renewal Kits → 3753BRK → P306

3753PB Reversible Ratchet with quick release button
Knarre, verstellbar mit Entriegelungsknopf
Cliquet, réversible avec bouton de débrayage



* Renewal Kits → 3753BRK → P306

3753NB Reversible Ratchet with quick release button
Knarre, verstellbar mit Entriegelungsknopf
Cliquet, réversible avec bouton de débrayage



* Renewal Kits → 3753BRK → P306

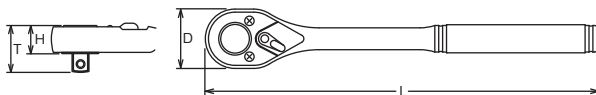

⚠ Reversible Ratchet with quick release button has less strength compared with normal ratchet due to the technical design. Make sure to use the ratchet correctly.

	D (mm)	T (mm)	H (mm)	L (mm)	(g)	(pce.)
3753JB	30.5	26.4	15.7	200	260	1
3753PB	30.5	26.4	15.7	200	286	1
3753NB	30.5	26.4	15.7	200	320	1

2774JS-3/8 Flexible Ratchet, reversible
Gelenk-Knarre, verstellbar
Cliquet articulé, réversible



* Renewal Kits → 2749RK-3/8 → P306

2774PS-3/8 Flexible Ratchet, reversible
Gelenk-Knarre, verstellbar
Cliquet articulé, réversible



* Renewal Kits → 2749RK-3/8 → P306

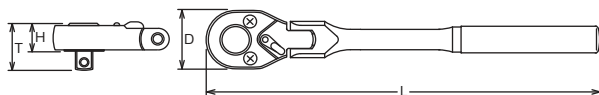

	D (mm)	T (mm)	H (mm)	L (mm)	(g)	(pce.)
2774JS-3/8	25	21.9	11.2	120	113	1
2774PS-3/8	25	21.9	11.2	120	133	1

⚠ 2774-3/8 series have less strength compared with normal 387 ratchet due to the technical design. Make sure to use the ratchet correctly.

3774PS Flexible Ratchet, reversible
Gelenk-Knarre, verstellbar
Cliquet articulé, réversible



* Renewal Kits → 3753RK → P306

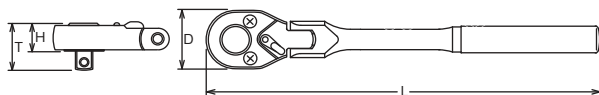

	D (mm)	T (mm)	H (mm)	L (mm)	(g)	(pce.)
3774PS	30.5	26.4	15.7	175	250	1

3/8" Hand Sockets Hand Steckschlüssel Douilles à main

Z-SERIES
HAND
TITANIUM
ACCESSORIES
SCREWDRIVERS
IMPACT
SLEEVE-DRIVE
PROTECTOR
INDUSTRIAL
AUTOMOTIVE
MOTORCYCLE
CONSTRUCTION
SPARE PART



* Renewal Kits → 3753RK → P306

3774J Flexible Ratchet, reversible
Gelenk-Knarre, verstellbar
Cliquet articulé, réversible



* Renewal Kits → 3753RK → P306

3774P Flexible Ratchet, reversible
Gelenk-Knarre, verstellbar
Cliquet articulé, réversible

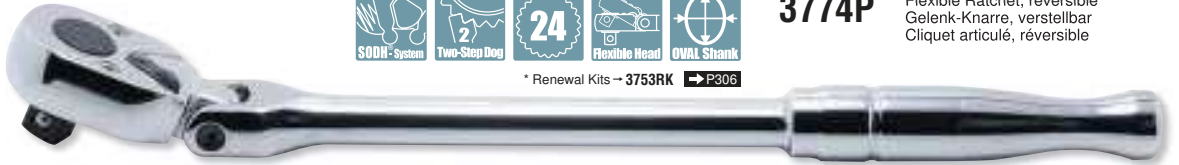

* Renewal Kits → 3753RK → P306

3774N Flexible Ratchet, reversible
Gelenk-Knarre, verstellbar
Cliquet articulé, réversible



	D (mm)	T (mm)	H (mm)	L (mm)	(g)	(pce.)
3774J	30.5	26.4	15.7	285	367	1
3774P	30.5	26.4	15.7	265	378	1
3774N	30.5	26.4	15.7	265	378	1

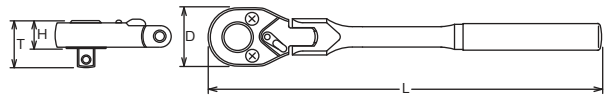

* Renewal Kits → 3753BRK → P306

3774JB Flexible Ratchet, reversible with quick release button
Gelenk-Knarre, verstellbar mit Entriegelungsknopf
3774PB Cliquet, articulée, réversible avec bouton de débrayage
3774NB



	D (mm)	T (mm)	H (mm)	L (mm)	(g)	(pce.)
3774JB	30.5	26.4	15.7	285	367	1
3774PB	30.5	26.4	15.7	265	373	1
3774NB	30.5	26.4	15.7	265	378	1

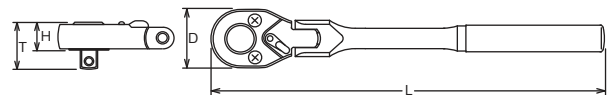

Reversible Ratchet with quick release button has less strength compared with normal ratchet due to the technical design. Make sure to use the ratchet correctly.

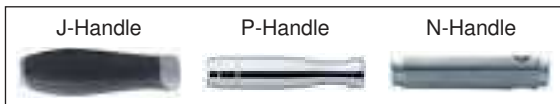

Reversible Ratchet with Quick Release Button :
Sockets and accessories are safely locked. By pushing the button the sockets or extension bars are released from the ratchet.

Umstellbare Knarre mit Entriegelungsknopf :
Steckschlüssel und Zubehörteile werden sicher und fest gehalten. Bei Drücken des Knopfes lösen sich die Teile.

Cliquet réversible avec bouton de débrayage :
Les douilles et accessoires ne peuvent plus se libérer. Une pression du pouce sur le bouton suffit pour les extraire.



* Renewal Kits → 3753RK → P306

3774JL Flex-Head Ratchet with Head Lock Button
Gelenk-Knarre, mit feststellbarem Gelenk
3774PL Cliquet à tête articulée avec bouton de blocage
3774NL



	D (mm)	T (mm)	H (mm)	L (mm)	(g)	(pce.)
3774JL	30.5	26.4	15.7	285	367	1
3774PL	30.5	26.4	15.7	265	378	1
3774NL	30.5	26.4	15.7	265	378	1

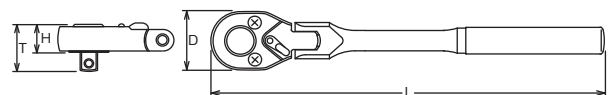

Z-SERIES
HAND
TITANIUM
SCREWDRIVERS ACCESSORIES
IMPACT
SLEEVE-DRIVE
PROTECTOR
INDUSTRIAL
AUTOMOTIVE
CONSTRUCTION MOTORCYCLE
SPARE PART

3774JBL

Flex-Head Ratchet with Head Lock Button and Quick Release Button
Gelenk-Knarre, mit feststellbarem Gelenk und Entriegelungsknopf
Cliquet à tête articulée avec bouton de blocage et de débrayage



* Renewal Kits → 3753BRK → P306

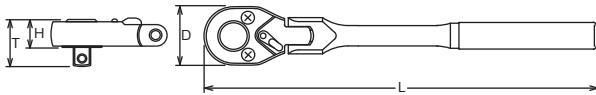

	D (mm)	T (mm)	H (mm)	L (mm)	(g)	(pce.)
3774JBL	30.5	26.4	15.7	285	367	1

⚠ Reversible Ratchet with quick release button has less strength compared with normal ratchet due to the technical design. Make sure to use the ratchet correctly.

3774P-SR

Speeder Ratchet
Kurbel-Knarre
Vilebrequin à cliquet



* Renewal Kits → 3753RK → P306

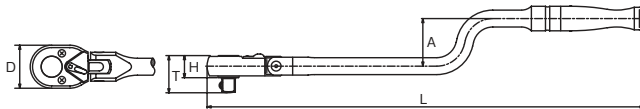

	D (mm)	T (mm)	H (mm)	A (mm)	L (mm)	(g)	(pce.)
3774P-SR	30.5	26.4	15.7	34	310	435	1

3776J

Swivel Head Ratchet
Schwenkopf-Knarre
Cliquet à tête pivotante



* Renewal Kits → 3752RK → P307



3776P

Swivel Head Ratchet
Schwenkopf-Knarre
Cliquet à tête pivotante



* Renewal Kits → 3752RK → P307



3776N

Swivel Head Ratchet
Schwenkopf-Knarre
Cliquet à tête pivotante



* Renewal Kits → 3752RK → P307

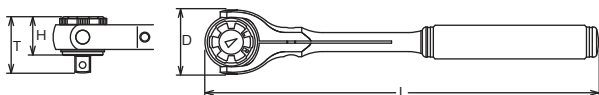

	D (mm)	T (mm)	H (mm)	L (mm)	(g)	(pce.)
3776J	44	34.3	23.9	280	510	1
3776P	44	34.3	23.9	280	560	1
3776N	44	34.3	23.9	280	565	1

45

* Renewal Kits → 3755RK → P307

	D (mm)	L (mm)	(g)	(pcs.)
3755	30.5	55	146	5

3755 Ratchet Adaptor
Aufsteckknarre
Cliquet adaptable

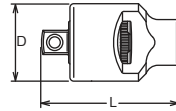

	D (mm)	L (mm)	(g)	(pcs.)
3756	30.5	25.5	47	10

3756 Quick Spinner
Rändel-Drehscheibe
Lanceur

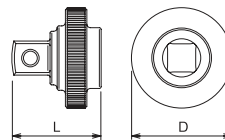

L/R Marking
45

* Renewal Kits → 3752RK → P307

	D (mm)	L (mm)	(g)	(pcs.)
3757	50	35	155	5

3757 Ratchet Wheel
Umstellbares Knarren-Handrad
Cliquet réversible à roue

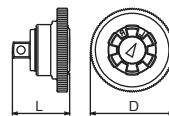

	D (mm)	L (mm)	(g)	(pcs.)
3762	19.3	300	178	2

3762 Flexible Extension Bar
Biegsame Verlängerung
Rallonge flexible

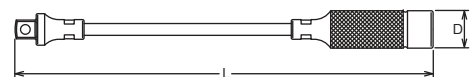

Z-SERIES
HAND
TITANIUM
ACCESSORIES
SCREWDRIVERS
IMPACT
SLEEVE-DRIVE
PROTECTOR
INDUSTRIAL
AUTOMOTIVE
MOTORCYCLE
CONSTRUCTION
SPARE PART

3760 Extension Bars Verlängerungen Rallonges

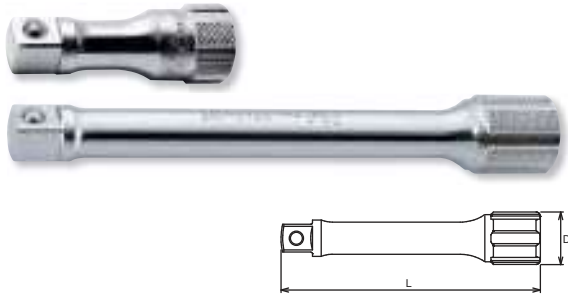

	D (mm)	L (mm)	(g)	(pcs.)
3760-32	18	32	27	10
3760-50	18	50	47	10
3760-75	18	75	68	10
3760-125	18	125	106	10
3760-150	18	150	125	10
3760-250	18	250	196	5
3760-300	18	300	291	2
3760-400	18	400	365	1
3760-500	18	500	490	1
3760-600	18	600	538	1
3760-900	18	900	805	1
3760-1000	18	1000	968	1

PK3760/6 Extension Set in Plastic Box Verlängerungen in Kunststoffkassette Jeu de rallonges en boîte plastique



PK3760/6 6 Pieces Set/△=670g

PLASTIC TRAY	
Extension Bars	
3760 Extension Bars 32, 50, 75, 125, 150, 250	

Rotation and general handling of extensions with oily hands is greatly improved with the **Koken** developed 6 point knurling. Also the **Koken** 6 point knurling stops the extensions from rolling around the work area.

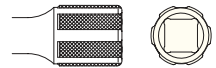

Durch die von **Koken** entwickelte 6 fache Rändelung wird die Handhabung deutlich erleichtert. Außerdem wird das Herumrollen der Verlängerungen wirksam verhindert.

La manipulation des rallonges est grandement facilitée par le profil moleté développé par **Koken**. Ce même profil empêche le roulement intempestif des rallonges sur le plan de travail.

3763 Wobble-Fix Extension Bars Winkel-Verlängerungen Rallonges angulaires



	D (mm)	L (mm)	(g)	(pcs.)
3763-32	18	32	26	10
3763-50	18	50	42	10
3763-75	18	75	57	10
3763-125	18	125	80	10
3763-150	18	150	98	10
3763-250	18	250	144	5
3763-300	18	300	170	2

PK3763/6 Wobble-Fix Extension Bars in Plastic Box Winkel-Verlängerungen in Kunststoffkassette Jeu de rallonges angulaires en boîte plastique



PK3763/6 6 Pieces Set/△=560g

PLASTIC TRAY	
Extension Bars	
3763 Wobble-Fix Extension Bars 32, 50, 75, 125, 150, 250	

Wobble-Fix Extension Bar

Two way usage

- a) In a fixed position, as a normal extension bar
- b) In a half-fixed position, as a flexible extension bar providing a 15° angle operation

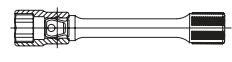

Winkel-Verlängerungen

Winkelverlängerungen lassen sich in zwei Einstellungen verwenden

- a) voll eingesteckt und starr,
- b) halb eingesteckt, mit einem Arbeitswinkel von 15°.

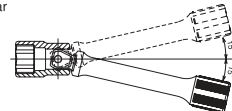

Rallonges angulaires

Deux utilisations possibles

- a) comme rallonge normale, dans une position fixe
- b) comme une rallonge angulaire avec une possibilité d'inclinaison jusqu'à 15°

The Wobble-Fix Extension Bar has less strength than normal extension bar due to it's specific design with a reduced square drive. Make sure to use it correctly.



* Renewal Kits → 3768RK → P309



OVAL SHAPE SHANK



RENEWAL KIT FOR HINGE HANDLE

3768J-250 Hinge Handle
Gelenkgriff
Poignée articulée



* Renewal Kits → 3768RK → P309

3768P-250 Hinge Handle
Gelenkgriff
Poignée articulée



* Renewal Kits → 3768RK → P309

3768P-380 Hinge Handle ⚠
Gelenkgriff
Poignée articulée



	D (mm)	L (mm)	(g)	(pcs.)
3768J-250	20.5	250	248	2
3768P-250	20.5	250	275	5
3768P-380	20.5	380	435	2

⚠ 3768P-380 has longer handle than standard, and can be loaded to excessive torque value. In the interest of your own safety always apply load evenly and progressively to avoid breakage and possible injury.

Der Gelenkgriff 3768-380 ist länger als die Standardversion. Aus Gründen Ihrer Sicherheit, sollten dies Werkzeug nie ruckartig sondern nach und nach belastet werden, um Bruch und damit verbundene, mögliche Verletzungen zu vermeiden.

Du au fait que les manches des 3768-380 sont plus longues que le standard, il y a risque d'une surcharge excessive lors du serrage. Pour éviter casse et blessure, veuillez serrer d'une façon régulière et progressive.

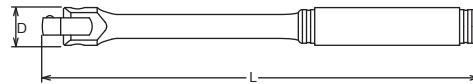

	H (mm)	L (mm)	(g)	(pcs.)
3769N				
160	50	160	110	2
230	120	230	135	2

3769N-160 / -230 Spin Type Handle ⚠
Drehgriff
Poignée emmanchée

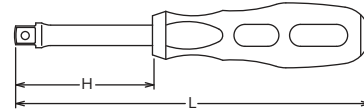

3769NWF-160 / -230

Spin Type Handle Wobble-Fix ⚠
Drehgriff, Wobble-Fix
Poignée emmanchée, angulaire

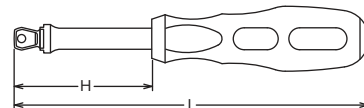

WOBBLE-FIX EXTENSION BAR



	H (mm)	L (mm)	(g)	(pcs.)
3769NWF				
160	50	160	110	2
230	120	230	135	2

⚠ Plastic or rubber handles are not intended to act as insulation.

Plastik-oder Gummigriffe stellen keinen Isolierschutz dar.

Les poignées en plastique ou en caoutchouc ne garantissent aucune isolation électrique.

	L (mm)	(g)	(pcs.)
3769H	170	210	2

3769H Folding Socket Driver
Klapp-Drehgriff
Poignée tournevis articulée

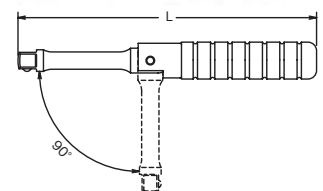
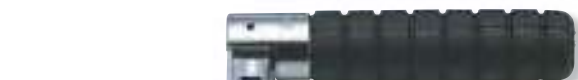

Z-SERIES
HAND
TITANIUM
SCREWDRIVERS ACCESSORIES
IMPACT
SLEEVE-DRIVE
PROTECTOR
INDUSTRIAL
AUTOMOTIVE
MOTORCYCLE
CONSTRUCTION
SPARE PART

3770 Universal Joint
Gelenk-Einsatz
Cardan universel

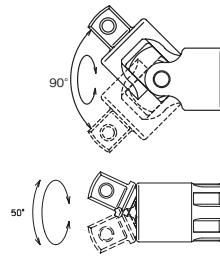
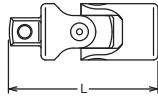

3771 Universal Joint
Gelenk-Einsatz
Joint articulé

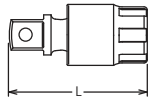

	L (mm)	(g)	(pcs.)
3770	50	66	10
3771	43	46	10

3780 Speed Handle
Winde
Vilebrequin

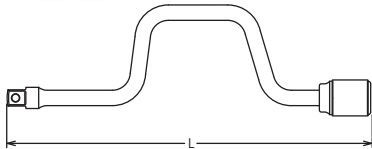

	L (mm)	(g)	(pcs.)
3780	400	432	1

3785 T-Handle
T-Griff
Poignée coulissante

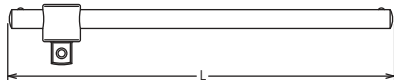

Innovative Oval shaped bar provides higher durability and stops the sliding square part turning around the bar.



3322A Adaptor
Verbindungsstück
Augmentateur

Warranty 86Nm
Garantie 86Nm
Garantie 86Nm

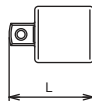

3344A Adaptor
Verbindungsstück
Augmentateur

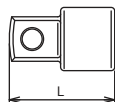

	L (mm)	(g)	(pcs.)
3785	200	157	5

	(sq)	(sq)	L (mm)	(g)	(pcs.)
3322A	3/8"	1/4"	24	18	10
3344A	3/8"	1/2"	30	35	10

⚠ Adapting down from bigger square drive to smaller square drive may lead to excessive torque and possibly cause breakage.

Reduzierstücke sind mit Vernunft einzusetzen. Es besteht Bruchgefahr. Überschreiten Sie niemals die Sicherheitsgrenzen.





Les réducteurs doivent être utilisés avec modération. Ne dépassez jamais la limites de sécurité.

PK2346/6 Adaptor Set in Plastic Box
Adaptor Satz in Kunststoffkassette
Jeu de adaptateur en boîte plastique

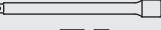

- 2233A (11/4") X 3/8"
- 3322A (3/8") X 1/4" Warranty/Garantia 86Nm
- 3344A (3/8") X 1/2"
- 4433A (1/2") X 3/8" Warranty/Garantia 290Nm
- 4466A (1/2") X 3/4"
- 6644A (3/4") X 1/2" Warranty/Garantia 668Nm

PK2346/6		6 Pieces Set / 460g	
PLASTIC TRAY			
Adaptors			
1/4" □ → 3/8" □	2233A	3/8" □ → 1/4" □	3322A
3/8" □ → 1/2" □	3344A	1/2" □ → 3/8" □	4433A-35
1/2" □ → 3/4" □	4466A	3/4" □ → 1/2" □	6644A

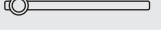
ESH3001 17 Pieces Set/△=2,200g	
METAL CASE:W415×H120×T50mm	
Sockets	Accessories
3410M Surface Drive Sockets 8, 9, 10, 11, 12, 13, 14, 15, 16, 17, 18, 19	 3753J  3760-125  3760-250  3770  3785









ESH3001 Socket Set
Steckschlüssel Satz
Jeu de clés à douille

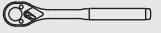

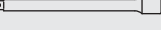
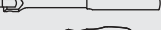
ETH3001 22 Pieces Set/△=1,820g	
METAL CASE:W392×H90×T50mm	
Sockets	Accessory
3425 TORX® Sockets E4, E5, E6, E7, E8 4425 TORX® Sockets E10, E11, E12, E14, E16, E18 3025.50 TORX® Bit Sockets T10, T15, T20, T25, T27 4025.60 TORX® Bit Sockets T30, T40, T45, T50, T55	 4433A-35



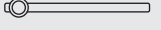

ETH3001 Socket Set
Steckschlüssel Satz
Jeu de clés à douille



3201AMW 42 Pieces Set/△=4,700g	
METAL CASE:W445×H190×T50mm	
Sockets	Accessories
3405M 12-pt. Sockets 9, 10, 11, 12, 13, 14, 15, 16, 17, 18, 19, 20, 21, 22 3405A 12-pt. Sockets 5/16, 3/8, 7/16, 1/2, 9/16, 5/8, 11/16, 3/4, 25/32, 13/16, 7/8 3405W 12-pt. Sockets 1/8, 3/16, 1/4, 5/16, 3/8, 7/16, 1/2	 3753N  3760-75  3760-125  3760-250  3768N-250  3769N-160  3770  3780  3785  3344A



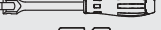



3201AMW Socket Set
Steckschlüssel Satz
Jeu de clés à douille



3206AM 27 Pieces Set/△=3,500g	
METAL CASE:W445×H190×T50mm	
Sockets	Accessories
3405M 12-pt. Sockets 7, 8, 10, 11, 12, 13, 14, 15, 16, 17, 19, 22 3405A 12-pt. Sockets 3/8, 7/16, 1/2, 9/16, 5/8, 11/16, 3/4, 13/16, 7/8 3300C Spark Plug Socket 20.8	 3753J  3760-125  3760-250  3768J-250  3770

3206AM Socket Set
Steckschlüssel Satz
Jeu de clés à douille



3210M-00 22 Pieces Set/△=2,900g 3210M-05 22 Pieces Set/△=2,900g 3210M-10 22 Pieces Set/△=2,900g	
METAL CASE:W360×H145×T50mm	
Sockets	Accessories
(3210M-00) 3400M 6-pt. Sockets 6, 7, 8, 9, 10, 11, 12, 13, 14, 15, 16, 17, 18, 19, 21, 22 (3210M-05) 3405M 12-pt. Sockets 6, 7, 8, 9, 10, 11, 12, 13, 14, 15, 16, 17, 18, 19, 21, 22 (3210M-10) 3410M Surface Drive Sockets 6, 7, 8, 9, 10, 11, 12, 13, 14, 15, 16, 17, 18, 19, 21, 22	 3753J  3760-125  3760-250  3768J-250  3770  3785

3210M-00 / 3210A-00 Socket Set
Steckschlüssel Satz
Jeu de clés à douille
3210M-05 / 3210A-05
3210M-10



3210A-00 18 Pieces Set/△=2,760g 3210A-05 18 Pieces Set/△=2,760g	
METAL CASE:W360×H145×T50mm	
Sockets	Accessories
(3210A-00) 3400A 6-pt. Sockets 1/4, 5/16, 11/32, 3/8, 7/16, 1/2, 9/16, 5/8, 11/16, 3/4, 13/16, 7/8 (3210A-05) 3405A 12-pt. Sockets 1/4, 5/16, 11/32, 3/8, 7/16, 1/2, 9/16, 5/8, 11/16, 3/4, 13/16, 7/8	 3753J  3760-125  3760-250  3768J-250  3770  3785

Z-SERIES
HAND
TITANIUM
ACCESSORIES
SCREWDRIVERS
IMPACT
SLEEVE-DRIVE
PROTECTOR
INDUSTRIAL
AUTOMOTIVE
MOTORCYCLE
CONSTRUCTION
SPARE PART

3216 Spark Plug Sockets Set
Zündkerzen-Schlüssel Satz
Jeu de douilles pour bougies



3216		4 Pieces Set/△=730g	
PLASTIC BAG			
Sockets		Accessories	
	3300C Spark Plug Sockets 16, 20.8		3760-125
			3774JL

3217M-00 Socket Set
Steckschlüssel Satz
Jeu de clés à douille
3217M-05
3217M-10



3217M-00		14 Pieces Set/△=850g	
3217M-05		14 Pieces Set/△=850g	
3217M-10		14 Pieces Set/△=850g	
METAL CASE:W163×H52×T33mm			
Sockets			
	(3217M-00) 3400M 6-pt. Sockets 9, 10, 11, 12, 13, 14, 15, 16, 17, 18, 19, 20, 21, 22		
	(3217M-05) 3405M 12-pt. Sockets 9, 10, 11, 12, 13, 14, 15, 16, 17, 18, 19, 20, 21, 22		
	(3217M-10) 3410M Surface Drive Sockets 9, 10, 11, 12, 13, 14, 15, 16, 17, 18, 19, 20, 21, 22		

S3240M-00 / S3240A-00 Display Stands
Ausstellungsstände
S3240M-05 / S3240A-05 Présentoirs



S3240M-00		3400M 177 Pieces Set/△=10,300g	
S3240M-05		3405M 177 Pieces Set/△=10,300g	
DISPLAY STAND:W510×H150×T230mm			
Sockets			
6mm:12pcs	12mm:12pcs	18mm:8pcs	
7mm:12pcs	13mm:11pcs	19mm:8pcs	
8mm:12pcs	14mm:11pcs	20mm:7pcs	
9mm:12pcs	15mm:10pcs	21mm:7pcs	
10mm:12pcs	16mm: 9pcs	22mm:7pcs	
11mm:12pcs	17mm: 9pcs	23mm:6pcs	

S3240A-00		3400A 126 Pieces Set/△=8,500g	
S3240A-05		3405A 126 Pieces Set/△=8,500g	
DISPLAY STAND:W510×H150×T230mm			
Sockets			
1/4" :12pcs	9/16":10pcs	25/32":7pcs	
5/16":12pcs	19/32":10pcs	13/16":7pcs	
3/8" :12pcs	5/8" : 9pcs	7/8" :7pcs	
7/16":12pcs	11/16": 9pcs		
1/2" :11pcs	3/4" : 8pcs		





3250M-00 Socket Set
Steckschlüssel Satz
Jeu de clés à douille
3250M-05



3250M-00		17 Pieces Set/△=2,200g	
3250M-05		17 Pieces Set/△=2,200g	
METAL CASE:W415×H120×T50mm			
Sockets		Accessories	
	3400M 6-pt. Sockets 7, 8, 10, 11, 12, 13, 14, 15, 16, 17, 18, 19		3753J
			3760-125
	3405M 12-pt. Sockets 7, 8, 10, 11, 12, 13, 14, 15, 16, 17, 18, 19		3760-250
			3770
			3785

3251 8 Pieces Set/△=675g

METAL CASE:W160×H100×T28mm

Sockets	Accessories
 3025.50 TORX® Bit Sockets T25H, T30H, T40H, T45H, T50H	 2774PS-3/8
	 3763-50
	 3756







3251

Bit Socket Set
Schraubendreher-Steckschlüssel Satz
Jeu de douilles de vissage



3252M 15 Pieces Set/△=1.530g

METAL CASE:W310×H90×T48mm

Sockets	Accessories
 3400M 6-pt. Sockets 5.5, 7, 8, 10, 11, 12	 3753P
 3405M 12-pt. Sockets 13, 14, 17, 19, 22	 3760-75
	 3760-125
	 3770









3252M

Socket Set
Steckschlüssel Satz
Jeu de clés à douille

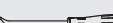

3275 24 Pieces Set/△=3.150g

METAL CASE:W400×H147×T50mm

Sockets	Accessories
 3400M 6-pt. Sockets 6, 7, 8, 9, 10, 11, 12	 3753J
 3405M 12-pt. Sockets 13, 14, 15, 16, 17, 18, 19, 21, 22	 3760-125
 3300C Spark Plug Sockets 16, 20.8	 3760-250
	 3768J-250
	 3770
	 3756







3275

Socket Set
Steckschlüssel Satz
Jeu de clés à douille

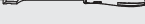

3277 29 Pieces Set/△=3.240g

METAL CASE:W370×H150×T50mm

Sockets	Accessories
 3400M 6-pt. Sockets 8, 9, 10, 11, 12	 3753J
 3405M 12-pt. Sockets 13, 14, 15, 16, 17, 18, 19, 21	 3760-125
 3300M 6-pt. Deep Sockets 8, 9, 10, 11, 12	 3768J-250
 3305M 12-pt. Deep Sockets 13, 14, 15, 16, 17, 18, 19, 21	







3277

Socket Set
Steckschlüssel Satz
Jeu de clés à douille



3278 20 Pieces Set/△=3.370g

METAL CASE:W310×H150×T50mm

Sockets	Accessories
 3000 Bit Sockets 2, 3	 3753J
 3010M.62 Hex Bit Sockets 5, 6, 7, 8, 10	 3763-125
 3020.50 XZN Bit Sockets M4, M5, M6, M8	
 3025.50 TORX® Bit Sockets T10, T15, T20, T25, T27, T30, T40	

3278

Bit Socket Set
Schraubendreher-Steckschlüssel Satz
Jeu de douilles de vissage



Hand Sockets
Hand Steckschlüssel
Douilles à main

1/2"

Z-SERIES
HAND
TITANIUM
SCREWDRIVERS ACCESSORIES
IMPACT
SLEEVE-DRIVE
PROTECTOR
INDUSTRIAL
AUTOMOTIVE
CONSTRUCTION MOTORCYCLE
SPARE PART

4401M ○ 6-point Sockets
6-kant Steckschlüssel
Douilles 6-pans



HANDY-ENDY®

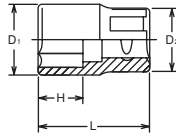

4401M 4406M (mm)	D ₁ (mm)	D ₂ (mm)	H (mm)	L (mm)	(g)	(pcs.)
8	13.2	22	8	36	44	10
9	13.8	22	8.5	37	44	10
10	15.3	22	9	37	45	10
11	16.5	22	9.5	37	46	10
12	17.8	22	10	37	47	10
13	19	22	10.5	37	53	10
14	20.3	22	11	37	56	10
15	21.5	22	11.5	37	52	10
16	22.8	22	12	37	62	10
17	24	22	12.5	37	69	10
18	25	23	13	37	74	10
19	26.5	24.5	14	38	89	10
20	27.8	26	15	38	92	10
21	29	27	15.5	38	102	10
22	30	28	16	40	113	10
23	31.5	29	16.5	40	128	10
24	32.8	30	17	42	140	5
25	34	31	18	42	164	5
26	35	32	19	42	165	5
27	36.5	33	19.5	43	196	5
28	37.8	34	20	43	198	5
29	39	35	20.5	43	190	5
30	40	36	22	46	222	5
31	41.5	37	22.5	46	257	5
32	42.8	38	23	46	250	5

4406M ○ 12-point Sockets
12-kant Steckschlüssel
Douilles 12-pans



HANDY-ENDY®

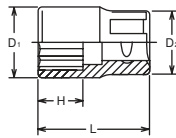

4400M ○ 6-point Sockets
6-kant Steckschlüssel
Douilles 6-pans

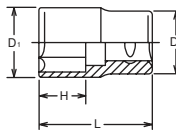

4400M 4405M (mm)	D ₁ (mm)	D ₂ (mm)	H (mm)	L (mm)	(g)	(pcs.)
33	44.2	39	24	47	275	5
34	45.2	40	24	47	315	5
35	46.2	40	24	47	317	5
36	47.2	41	24	47	336	5
37	48.3	42	24	47	360	5
38	49.2	43	24	47	380	5
41	53.1	45	29	57	471	5
46	59.1	48	32	60	567	2

4405M ○ 12-point Sockets
12-kant Steckschlüssel
Douilles 12-pans

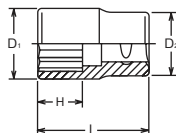

RS4401M/10 ○ Socket Set on Rail
Steckschlüsselsatz auf Schiene
Jeu de douilles sur rail



RS4401M/10	10 Pieces Set/Rail 300mm	(g)
10, 11, 12, 13, 14, 15, 16, 17, 18, 19		720

RS4406M/10 ○ Socket Set on Rail
Steckschlüsselsatz auf Schiene
Jeu de douilles sur rail



RS4406M/10	10 Pieces Set/Rail 300mm	(g)
10, 11, 12, 13, 14, 15, 16, 17, 18, 19		720

4400A 4405A (inch)	D ₁ (mm)	D ₂ (mm)	H (mm)	L (mm)	(g)	(pcs.)
1/4	10.7	21	6	36	41	10
5/16	13.2	21	8	36	44	10
3/8	14.6	21	9	37	45	10
7/16	16.5	21	9.5	37	46	10
1/2	19	22	10.5	37	53	10
9/16	20.3	22	11	37	56	10
19/32	21.5	22	11.5	37	52	10
5/8	22.8	22	12	37	62	10
21/32	24	23	12.5	37	69	10
11/16	25	24	13	37	74	10
3/4	26.5	25	14	38	89	10
25/32	27.8	26	15	38	92	10
13/16	29	27	15.5	38	102	10
7/8	30	28	16	40	113	10
15/16	32.8	30	17	42	140	5
31/32	34	31	18	42	165	5
1	35	32	19	42	165	5
1. 1/16	36.5	33	19.5	43	180	5
1. 1/8	39	35	20.5	43	210	5
1. 3/16	40	36	22	46	222	5
1. 1/4	42.8	38	23	46	250	5
1. 5/16	44.2	39	24	47	275	5
1. 3/8	46.2	40	24	47	317	5
1. 7/16	47.2	41	24	47	336	5
1. 1/2	49.2	43	24	47	380	5

Hand Sockets
Both, 6-pt. and 12-pt. openings, are equipped with Flat Drive Openings, transferring the turning power from the corners on the flanks of nuts and bolts.

Sowohl 6-kant als auch 12-kant Steckschlüssel bieten alle Vorteile der "Flat Drive" Öffnung, die die Greifzonen auf die Flächen von Schrauben und Muttern versetzt.

Aussi bien les douilles 6-pans que 12-pans présentent tous les avantages liés au profil FLATDRIVE qui applique la force de serrage aux faces de la vis ou de l'écrou.

4400A 6-point Sockets 6-kant Steckschlüssel Douilles 6-pans

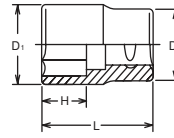

4405A 12-point Sockets 12-kant Steckschlüssel Douilles 12-pans

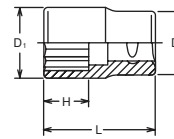









RS4400A/10	10 Pieces Set/Rail 300mm	 (g)
3/8, 7/16, 1/2, 9/16, 5/8, 11/16, 3/4, 13/16, 7/8, 15/16		809

RS4405A/10	10 Pieces Set/Rail 300mm	 (g)
3/8, 7/16, 1/2, 9/16, 5/8, 11/16, 3/4, 13/16, 7/8, 15/16		809

RS4400A/10 Socket Set on Rail Steckschlüsselsatz auf Schiene Jeu de douilles sur rail

RS4405A/10 Socket Set on Rail Steckschlüsselsatz auf Schiene Jeu de douilles sur rail



	 6-Point	 12-Point	 Surface Drive	 Nut Grip®	 TORX® (E)	 TORXPLUS® (EPL)	 Double Square	 LHSTIX® (LH-S)
1/4"	No. 2400M/A No. 2300M/A No. 2400W-BA No. 2300W-BA No. 2300X series	No. 2405M/A No. 2305M/A No. AS2405A No. AS2305A series	No. 2410M No. 2310M series	No. 2450MS No. 2350M No. 2350X series	No. 2425 No. 2325 series	—	No. 2415M/A series	—
3/8"	No. 3400M/A No. 3300M/A No. 3400W No. 3300W No. 3300X/XA series	No. 3405M/A No. 3305M/A No. 3405W No. 3305W No. 3305X/XA series	No. 3410M No. 3310M series	No. 3450M No. 3450MH No. 3350M No. 3350X series	No. 3425 No. 3325 series	—	No. 3415M/A series	No. 3400LH series
1/2"	No. 4400M/A No. 4401M No. 4300M/A No. 4400W series	No. 4405M/A No. 4406M No. 4305M/A No. 4405W series	No. 4410M No. 4310M series	No. 4450M series	No. 4425 No. 4325 series	No. 4425-EPL series	—	No. 4400LH series

Z-SERIES
HAND
TITANIUM
SCREWDRIVERS ACCESSORIES
IMPACT
SLEEVE-DRIVE
PROTECTOR
INDUSTRIAL
AUTOMOTIVE
MOTORCYCLE
CONSTRUCTION
SPARE PART

4410M



Surface Drive Sockets
Surface Drive Steckschlüssel
Douilles, Surface Drive

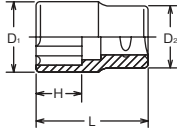

RS4410M/10



Socket Set on Rail
Steckschlüsselsatz auf Schiene
Jeu de douilles sur rail



SURFACE DRIVE

Surface drive sockets are designed to retain contact with the flat sides of the nut in order to transmit higher torque and reduce nut wear. These sockets are ideal for using on polished nuts, aluminum nuts and nuts with worn out points.

Das Profil unserer Surface-Drive Steckschlüssel greift die Schraube an deren Flächen. Dies sichert eine höhere Kraftübertragung und verhindert ein Durchrutschen des Steckschlüssels. Diese Steckschlüssel eignen sich besonders für polierte Schrauben, Aluminium Schrauben und Schrauben bei denen die Ecken bereits abgerundet sind.

Notre profil Surface Drive assure le contact entre la douille et les plats de l'écrou. Ceci réduit l'usure et permet la transmission d'un couple plus élevé. C'est une solution idéale pour les écrous polies, celles en aluminium ou arrondies.

4400W



6-point Whitworth Sockets
6-kant Steckschlüssel, Whitworth
Douilles à 6-pans Whitworth

4405W



12-point Whitworth Sockets
12-kant Steckschlüssel, Whitworth
Douilles à 12-pans Whitworth

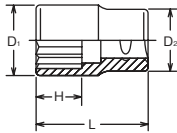

RS4400W/8



Socket Set on Rail
Steckschlüsselsatz auf Schiene
Jeu de douilles sur rail

RS4405W/8



BS W



BS · W	BS	3/16BS	1/4BS	5/16BS	3/8BS	7/16BS	1/2BS	9/16BS	5/8BS	11/16BS	3/4BS	7/8BS
	W	1/8W	3/16W	1/4W	5/16W	3/8W	7/16W	1/2W	9/16W	5/8W	11/16W	3/4W
S	(ref. mm)	8.64	11.30	13.34	15.24	18.03	20.83	23.37	25.65	27.94	30.48	33.35

4425-N



TORX® Sockets
TORX® Steckschlüssel
Douilles TORX®

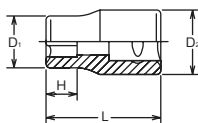

RS4425/6-N



Socket Set on Rail
Steckschlüsselsatz auf Schiene
Jeu de douilles sur rail



4410M (mm)	D ₁ (mm)	D ₂ (mm)	H (mm)	L (mm)	(g)	(pcs.)
8	13.2	21	8	36	44	10
9	13.8	21	8.5	37	44	10
10	15.3	21	9	37	45	10
11	16.5	21	9.5	37	46	10
12	17.8	21	10	37	47	10
13	19	22	10.5	37	53	10
14	20.3	22	11	37	56	10
15	21.5	22	11.5	37	52	10
16	22.8	22	12	37	62	10
17	24	23	12.5	37	69	10
18	25	24	13	37	74	10
19	26.5	25	14	38	89	10
20	27.8	26	15	38	92	10
21	29	27	15.5	38	102	10
22	30	28	16	40	113	10
23	31.5	29	16.5	40	128	10
24	32.8	30	17	42	140	5
25	34	31	18	42	164	5
26	35	32	19	42	165	5
27	36.5	33	19.5	43	196	5
28	37.8	34	20	43	198	5
29	39	35	20.5	43	190	5
30	40	36	22	46	222	5
31	41.5	37	22.5	46	257	5
32	42.8	38	23	46	250	5
34	45.2	40	24	47	314	5

RS4410M/10	10 Pieces Set/Rail 300mm	(g)
10, 11, 12, 13, 14, 15, 17, 19, 21, 22		717

4400W / 4405W (W)	D ₁ (mm)	D ₂ (mm)	H (mm)	L (mm)	(g)	(pcs.)
3/16	16.5	21	9.5	37	46	10
1/4	19	22	10.5	37	54	10
5/16	21.5	22	11.5	37	54	10
3/8	25	24	13	37	73	10
7/16	29	27	15.5	38	87	10
1/2	31.5	29	16.5	40	133	10
9/16	35	32	19	42	165	5
5/8	37.8	34	20	43	191	5
11/16	40	36	22	46	222	5
3/4	44.2	39	24	47	280	5

RS4400W/8	8 Pieces Set/Rail 250mm	(g)
3/16, 1/4, 5/16, 3/8, 7/16, 1/2, 9/16, 5/8		860

RS4405W/8	8 Pieces Set/Rail 250mm	(g)
3/16, 1/4, 5/16, 3/8, 7/16, 1/2, 9/16, 5/8		860

4425 (E)	D ₁ (mm)	D ₂ (mm)	H (mm)	L (mm)	(g)	(pcs.)
E10N	13.2	21	8.2	36	47	10
E12N	14.6	21	9.3	37	48	10
E14N	16.5	21	10.6	37	50	10
E16N	19	22	11.8	37	60	10
E18N	20.3	22	13	37	60	10
E20N	22.8	22	14.4	37	65	10

TORX Socket for Nut and low profile bolt
Shallow Chamfer on Socket Opening



A : Flywheel bolt MR20 NISSAN: 4425-E20N
B : Cam sprocket FA20 for TOYOTA/SUBARU: 4425-E16N
C : Connecting rod bolt FA20 for TOYOTA/SUBARU: 4425-E14N

RS4425/6-N	6 Pieces Set/Rail 200mm	(g)
E10N, E12N, E14N, E16N, E18N, E20N		370

4425 (E)	D ₁ (mm)	D ₂ (mm)	H (mm)	L (mm)	(g)	(pcs.)
E 8	10.7	21	7	36	41	10
E10	13.2	21	8.2	36	44	10
E11	13.8	21	8.7	37	45	10
E12	14.6	21	9.3	37	47	10
E14	16.5	21	10.6	37	48	10
E16	19	22	11.8	37	57	10
E18	20.3	22	13	37	57	10
E20	22.8	22	14.4	37	63	10
E22	25	24	15.5	37	78	10
E24	26.5	25	17	40	95	5

RS4425/7	7 Pieces Set/Rail 200mm	(g)
E10, E12, E14, E16, E18, E20, E24		428

4425 TORX® Sockets TORX® Steckschlüssel Douilles TORX®

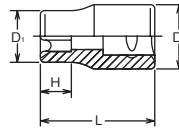

RS4425/7 Socket Set on Rail Steckschlüsselsatz auf Schiene Jeu de douilles sur rail



TORX® (E)

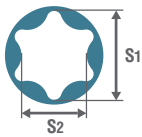

E	E4	E5	E6	E7	E8	E10	E11	E12	E14	E16	E18	E20	E22	E24	E26	E28	E30	E32
S ₁ (ref. mm)	3.7	4.6	5.6	6.1	7.4	9.3	9.9	11.0	12.8	14.6	16.5	18.3	20.1	22.0	23.7	25.5	27.3	29.0
S ₂ (ref. mm)	2.7	3.3	4.0	4.3	5.3	6.8	7.1	7.9	9.2	10.5	11.9	13.2	14.8	15.7	17.5	18.3	20.0	21.3

4425 (EPL)	D ₁ (mm)	D ₂ (mm)	H (mm)	L (mm)	(g)	(pcs.)
10EPL	13.2	21	6.2	36	45	10
12EPL	14.6	21	7.2	37	47	10
14EPL	16.5	21	8.1	37	49	10
16EPL	19	22	9.2	37	60	10
18EPL	20.3	22	10.2	37	60	10
20EPL	22.9	22	11.2	37	65	10

RS4425/6-EPL	6 Pieces Set/Rail 200mm	(g)
10EPL, 12EPL, 14EPL, 16EPL, 18EPL, 20EPL		390

4425 (EPL) TORXPLUS® Sockets TORXPLUS® Steckschlüssel Douilles TORXPLUS®

TORXplus®

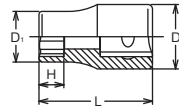

RS4425/6-EPL Socket Set on Rail Steckschlüsselsatz auf Schiene Jeu de douilles sur rail



TORXplus® (EP/EPL)

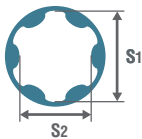

EP/EPL	8EP	10EP	12EP	14EP	16EP	18EP	20EP	22EP	24EP	26EP	28EP	30EP	32EP
S ₁ (ref. mm)	7.4	9.3	11.0	12.8	14.6	16.5	18.3	20.1	22.0	23.7	25.5	27.3	29.0
S ₂ (ref. mm)	5.3	6.8	7.9	9.2	10.5	11.9	13.2	14.8	15.7	17.5	18.3	20.0	21.3

TORXplus®

TORX PLUS
EP/EPL-style



TORX
E-style



Straight Sidewalls & Reduced Recess Fall Away

- Increase tool engagement
- Virtually eliminates camout
- Ensures proper torque transfer
- Greatly reduces end load requirements
- Can reduce worker fatigue and muscular stress during manual assembly

Elliptically-based Geometry and Lobe Engagement

- Broadens contact surface to maximize engagement of driver and recess
- Eliminates damaging point-to-point contact

0° Drive Angle

- Optimises torque transmission
- Virtually eliminates radial stresses to increase tool bit life
- Enables use of recesses with thinner walls

Six Lobes with Large Cross-Sectional Areas

- Enables faster tool engagement
- Maximizes torque transfer
- Increases torsional strength

TORX is a registered trademark of CAMCAR Innovations.
TORX ist ein registriertes Markenzeichen der Firma CAMCAR Innovations.
TORX est une marque déposée de CAMCAR Innovations.

TORXplus is a registered trademark of CAMCAR Innovations.
TORXplus ist ein registriertes Markenzeichen der Firma CAMCAR Innovations.
TORXplus est une marque déposée de CAMCAR Innovations.

Hand Sockets Hand Steckschlüssel Douilles à main

1/2"

Z-SERIES
HAND
TITANIUM
SCREWDRIVERS
ACCESSORIES
IMPACT
SLEEVE-DRIVE
PROTECTOR
INDUSTRIAL
AUTOMOTIVE
MOTORCYCLE
CONSTRUCTION
SPARE PART

4400LH

 LHSTIX® Sockets
Steckschlüssel mit LHSTIX® Profil
Douilles au profil LHSTIX®

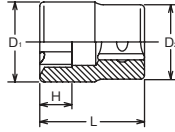

4400LH (LH-S)	D ₁ (mm)	D ₂ (mm)	H (mm)	L (mm)	(g)	(pcs.)
6S	13.2	21	5.6	36	44	10
8S	16.5	21	6.8	37	46	10
10S	19	22	8	37	53	10
12S	22.8	22	9.2	37	62	10
14S	25	24	10.4	37	74	10
16S	29	27	11.6	38	102	10

RS4400LH/6

  Socket Set on Rail
Steckschlüsselsatz auf Schiene
Jeu de douilles sur rail



RS4400LH/6	6 Pieces Set/Rail 200mm	(g)
6S, 8S, 10S, 12S, 14S, 16S		430

LHSTIX®

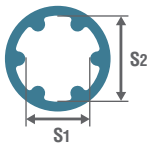

LH-S	LH-5S	LH-6S	LH-8S	LH-10S	LH-12S	LH-14S	LH-16S
S ₁ (ref. mm)	5.6	6.8	9.0	11.3	13.6	15.8	18.1
S ₂ (ref. mm)	7.5	9.0	12.0	15.0	18.0	21.0	24.0

4450M

 Nut Grip Sockets **Nut Grip®**
Steckschlüssel mit 2-facher Kugelhalterung
Douilles à billes de retenue

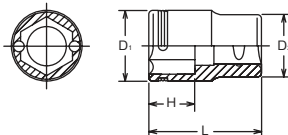

4450M (mm)	D ₁ (mm)	D ₂ (mm)	H (mm)	L (mm)	(g)	(pcs.)
10	15.3	21	6	36	44	10
11	16.5	21	6.5	36	46	10
12	17.8	21	7	36	46	10
13	19	22	8	36	52	10
14	20.3	22	8.5	36	54	10
15	21.5	22	9	36	52	10
16	22.8	22	9	36	60	10
17	24	23	9.5	36	68	10
18	25	24	10.5	36	77	10
19	26.5	25	11.5	36	85	10
21	29	27	12	37	110	10
22	30	28	12.5	37	105	10
24	32.8	30	14.5	39	130	5
27	36.5	33	16.5	40	139	5

NUT GRIP®

Twin balls at the 6-point opening hold bolt/nut tightly for safe and reliable work.

Die zwei Kugeln in der 6-kant Öffnung unserer NUT GRIP Steckschlüssel halten die Schraube sicher im Steckschlüssel. Dies erlaubt ein Arbeiten auch an schwer zugänglichen Stellen.

Les 2 billes dans l'ouverture du 6-pans de la douille retiennent l'écrou de manière sûre et efficace.

RS4450M/10

  Socket Set on Rail
Steckschlüsselsatz auf Schiene
Jeu de douilles sur rail



RS4450M/10	10 Pieces Set/Rail 300mm	(g)
10, 11, 12, 13, 14, 15, 17, 19, 21, 22		717

1/2"

Hand Sockets Hand Steckschlüssel Douilles à main

4300M / 4300A

6-point Deep Sockets
6-kant Steckschlüssel, lang
Douilles longues, 6-pans

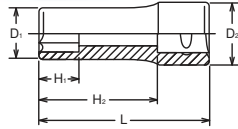

4300M 4305M (mm)	D ₁ (mm)	D ₂ (mm)	H ₁ (mm)	H ₂ (mm)	L (mm)	(g)	(pcs.)
8	13.2	21	9	59	77	76	10
9	13.8	21	10	59	77	82	10
10	15.3	21	11	59	77	82	10
11	16.5	21	12	59	77	86	10
12	17.8	21	13	59	77	92	10
13	19	21.8	14	59	77	106	10
14	20.3	21.8	15	59	77	115	10
15	21.5	21.8	16	59	77	123	10
16	22.8	22	17	59	77	141	10
17	24	23	18	59	77	139	10
18	25	24	19	59	77	149	10
19	26.5	25	20	58	77	165	10
20	27.8	26	21	58	77	183	10
21	29	27	23	58	77	190	10
22	30	28	27	57	77	200	10
23	31.5	29	27	57	77	233	10
24	32.8	30	27	57	77	249	10
25	34	31	27	57	77	270	10
26	35	32	27	56	77	279	10
27	36.5	33	28	56	77	303	10
28	37.8	34	28	56	77	331	10
29	39	35	28	55	77	357	10
30	40	36	34	55	77	342	10
31	41.5	37	34	55	77	384	10
32	42.8	38	34	55	77	405	10
33	44.2	39	35	54	77	420	5
34	45.2	40	35	54	77	442	5
35	46.2	40	35	53	77	458	5
36	47.2	41	35	53	77	484	5
37	48.2	42	38	53	77	475	5
38	49	44	38	53	77	490	5

4305M / 4305A

12-point Deep Sockets
12-kant Steckschlüssel, lang
Douilles longues, 12-pans

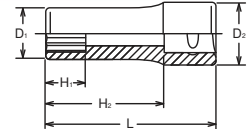

4300A 4305A (inch)	D ₁ (mm)	D ₂ (mm)	H ₁ (mm)	H ₂ (mm)	L (mm)	(g)	(pcs.)
5/16	13.2	21	9	59	77	76	10
3/8	14.6	21	10	59	77	82	10
7/16	16.5	21	12	59	77	86	10
1/2	19	21.8	14	59	77	106	10
9/16	20.3	21.8	15	59	77	115	10
19/32	21.5	21.8	16	59	77	123	10
5/8	22.8	22	17	59	77	141	10
21/32	24	23	18	59	77	139	10
11/16	25	24	19	59	77	149	10
3/4	26.5	25	20	58	77	165	10
25/32	27.8	26	21	58	77	183	10
13/16	29	27	23	58	77	190	10
7/8	30	28	27	57	77	200	10
15/16	32.8	30	27	57	77	249	10
31/32	34	31	27	57	77	270	10
1	35	32	27	56	77	279	10
1. 1/16	36.5	33	28	56	77	303	10
1. 1/8	37.8	34	28	56	77	331	10
1. 3/16	40	36	34	55	77	342	10
1. 1/4	42.8	38	34	55	77	405	10
1. 5/16	44.2	39	35	54	77	420	5
1. 3/8	46.2	40	35	54	77	422	5
1. 7/16	47.2	41	35	53	77	484	5
1. 1/2	49	44	38	53	77	523	5
1.13/16	59	48	38	51	77	791	2

RS4300M/10	10 Pieces Set/Rail 300mm	(g)
10, 11, 12, 13, 14, 15, 17, 19, 21, 22	1,415	

RS4305M/10	10 Pieces Set/Rail 300mm	(g)
10, 11, 12, 13, 14, 15, 17, 19, 21, 22	1,415	

RS4300M /12	12 Pieces Set/Rail 300mm	(g)
10, 12, 13, 14, 15, 16, 17, 18, 19, 20, 21, 22	1,825	

RS4300A/10	10 Pieces Set/Rail 300mm	(g)
3/8, 7/16, 1/2, 9/16, 5/8, 11/16, 3/4, 13/16, 7/8, 15/16	1,600	

RS4305A/10	10 Pieces Set/Rail 300mm	(g)
3/8, 7/16, 1/2, 9/16, 5/8, 11/16, 3/4, 13/16, 7/8, 15/16	1,600	

RS4300M/10 RS4305M/10

Socket Set on Rail
Steckschlüsselsatz auf Schiene
Jeu de douilles sur rail



RS4300M/12

Socket Set on Rail
Steckschlüsselsatz auf Schiene
Jeu de douilles sur rail



RS4300A/10 RS4305A/10

Socket Set on Rail
Steckschlüsselsatz auf Schiene
Jeu de douilles sur rail



Z-SERIES
HAND
TITANIUM
ACCESSORIES
SCREWDRIVERS
IMPACT
SLEEVE-DRIVE
PROTECTOR
INDUSTRIAL
AUTOMOTIVE
MOTORCYCLE
CONSTRUCTION
SPARE PART

Hand Sockets Hand Steckschlüssel Douilles à main

1/2"

Z-SERIES
HAND
TITANIUM
SCREWDRIVERS
ACCESSORIES
IMPACT
SLEEVE-DRIVE
PROTECTOR
INDUSTRIAL
AUTOMOTIVE
CONSTRUCTION
MOTORCYCLE
SPARE PART

4310M

Surface Drive Deep Sockets
Surface Drive Steckschlüssel, lang
Douilles longues, Surface Drive

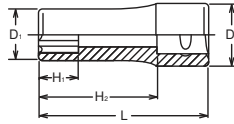
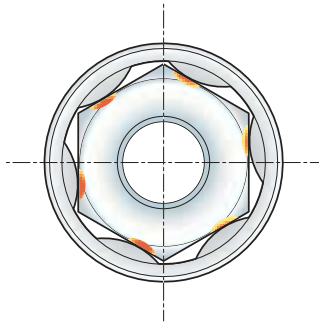

4310M (mm)	D ₁ (mm)	D ₂ (mm)	H ₁ (mm)	H ₂ (mm)	L (mm)	(g)	(pcs.)
8	13.2	21	9	59	77	79	10
9	13.8	21	10	59	77	82	10
10	15.3	21	11	59	77	82	10
11	16.5	21	12	59	77	86	10
12	17.8	21	13	59	77	92	10
13	19	21.8	14	59	77	106	10
14	20.3	21.8	15	59	77	115	10
15	21.5	21.8	16	59	77	123	10
16	22.8	22	17	59	77	141	10
17	24	23	18	59	77	139	10
18	25	24	19	59	77	149	10
19	26.5	25	20	58	77	165	10
20	27.8	26	21	58	77	183	10
21	29	27	23	58	77	190	10
22	30	28	27	57	77	200	10
23	31.5	29	27	57	77	233	10
24	32.8	30	27	57	77	249	10
25	34	31	27	57	77	270	10
26	35	32	27	56	77	279	10
27	36.5	33	28	56	77	303	10
28	37.8	34	28	56	77	334	10
29	39	35	28	55	77	357	10
30	40	36	34	55	77	342	10
31	41.5	37	34	55	77	384	10
32	42.8	38	34	55	77	405	10
34	45.2	40	35	54	77	442	5

RS4310M/10

Socket Set on Rail
Steckschlüsselsatz auf Schiene
Jeu de douilles sur rail



RS4310M/10	10 Pieces Set/Rail 300mm	(g)
10, 11, 12, 13, 14, 15, 17, 19, 21, 22		1,415

4325

TORX® Deep Sockets
TORX® Steckschlüssel, lang
Douilles longues TORX®

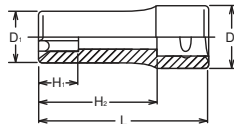

4325 (E)	D ₁ (mm)	D ₂ (mm)	H ₁ (mm)	H ₂ (mm)	L (mm)	(g)	(pcs.)
E 8	10.7	21	7	59	77	68	10
E10	13.2	21	8.2	59	77	99	10
E11	13.8	21	8.7	59	77	84	10
E12	14.6	21	9.3	59	77	99	10
E14	16.5	21	10.6	59	77	103	10
E16	19	21.8	11.8	59	77	107	10
E18	20.3	21.8	13	59	77	118	10
E20	22.8	22	14.4	59	77	141	10
E22	25	24	15.5	59	77	188	10
E24	26.6	25	17	59	77	215	10

RS4325/7

Socket Set on Rail
Steckschlüsselsatz auf Schiene
Jeu de douilles sur rail



RS4325/7	7 Pieces Set/Rail 200mm	(g)
E10, E12, E14, E16, E18, E20, E24		900

TORX®
(E)

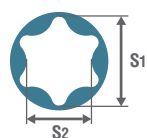

E	E4	E5	E6	E7	E8	E10	E11	E12	E14	E16	E18	E20	E22	E24	E26	E28	E30	E32
S ₁ (ref. mm)	3.7	4.6	5.6	6.1	7.4	9.3	9.9	11.0	12.8	14.6	16.5	18.3	20.1	22.0	23.7	25.5	27.3	29.0
S ₂ (ref. mm)	2.7	3.3	4.0	4.3	5.3	6.8	7.1	7.9	9.2	10.5	11.9	13.2	14.8	15.7	17.5	18.3	20.0	21.3

4300M(L120) (mm)	D ₁ (mm)	D ₂ (mm)	H ₁ (mm)	H ₂ (mm)	L (mm)	(g)	(pcs.)
8	13.2	21	9	102	120	120	5
10	15.3	21	11	102	120	138	5
12	17.8	21	13	102	120	157	5
14	20.3	21.8	15	102	120	193	5
16	22.8	22	17	102	120	210	5

4300M (L120) 6-point Extra Deep Sockets 6-kant Steckschlüssel, extra lang Douilles extra longues 6-pans

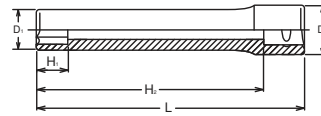

4325(L140) (E)	D ₁ (mm)	D ₂ (mm)	H ₁ (mm)	H ₂ (mm)	L (mm)	(g)	(pcs.)
E 8	10.7	21	7	122	140	110	5
E10	13.2	21	8.2	122	140	140	5
E12	14.6	21	9.3	122	140	160	5
E14	16.5	21	10.6	122	140	180	5

4325 (L140) TORX® Extra Deep Sockets TORX® Steckschlüssel, extra lang Douilles extra longues TORX®

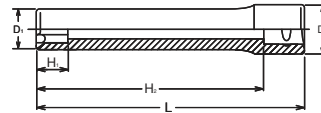

4325(L140) (E)	D ₁ (mm)	D ₂ (mm)	H ₁ (mm)	H ₂ (mm)	L (mm)	(g)	(pcs.)
E 8(2B)	10.7	21	6.6	122	140	110	5
E10(2B)	13.2	21	7.4	122	140	140	5
E12(2B)	14.6	21	9	122	140	160	5
E14(2B)	16.5	21	9.8	122	140	180	5

4325 (L140)-2B TORX® Sockets Nut Grip® TORX® Steckschlüssel mit 2-facher Kugelhalterung Douilles TORX® à deux billes de retenue

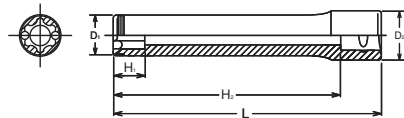

For Cylinder head bolt



NUT GRIP®

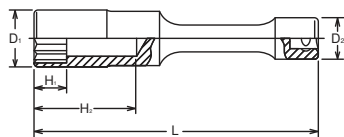

4117M-125 / -250 Extended Sockets Schaftsteckschlüssel Douilles rallongées



4117M-125 (mm)	D ₁ (mm)	D ₂ (mm)	H ₁ (mm)	H ₂ (mm)	L (mm)	(g)	(pce.)
13	18.7	24	13	59	125	213	1
14	20.2	24	14	59	125	227	1
17	24	24	17	59	125	274	1
19	26.9	24	19	59	125	279	1
21	28.5	24	21	59	125	291	1
22	30	24	22	59	125	323	1
24	32	24	24	59	125	361	1
27	36.5	24	27	59	125	439	1
30	40	24	30	59	125	461	1
32	42	24	32	59	125	498	1

4117M-250 (mm)	D ₁ (mm)	D ₂ (mm)	H ₁ (mm)	H ₂ (mm)	L (mm)	(g)	(pce.)
13	18.7	24	13	59	250	412	1
14	20.2	24	14	59	250	423	1
17	24	24	17	59	250	469	1
19	26.9	24	19	59	250	484	1
21	28.5	24	21	59	250	496	1
22	30	24	22	59	250	516	1
24	32	24	24	59	250	560	1
27	36.5	24	27	59	250	641	1
30	40	24	30	59	250	663	1
32	42	24	32	59	250	698	1

4440M / 4440A 6-point Universal Sockets 6-kant Gelenk-Einsätze Douilles articulées, 6-pans

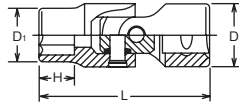

4440A (inch)	D ₁ (mm)	D ₂ (mm)	H (mm)	L (mm)	(g)	(pcs.)
3/8	14.8	25	8.8	63	155	10
7/16	16.5	25	10	65	158	10
1/2	19	25	11.4	66	152	10
9/16	20.3	25	11.4	66	151	10
5/8	22.8	25	13	68	150	10
11/16	24.6	25	14	69	153	10
3/4	26.5	25	15	71	170	10
7/8	30.3	25	16	72	185	5

4440M (mm)	D ₁ (mm)	D ₂ (mm)	H (mm)	L (mm)	(g)	(pcs.)
9	14	25	8.3	63	150	10
10	15.3	25	8.8	63	155	10
11	16.5	25	10	65	158	10
12	17.8	25	10.5	65	151	10
13	19	25	11.4	66	152	10
14	20.3	25	11.4	66	151	10
15	21.5	25	13	68	149	10
16	22.8	25	13	68	150	10
17	24	25	14	69	150	10
18	25.3	25	14	69	150	10
19	26.5	25	15	71	170	10
20	27.8	25	15	71	173	5
21	29	25	16	72	176	5
22	30.3	25	16	72	185	5

4445M / 4445A 12-point Universal Sockets 12-kant Gelenk-Einsätze Douilles articulées, 12-pans

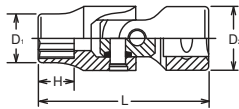

4445A (inch)	D ₁ (mm)	D ₂ (mm)	H (mm)	L (mm)	(g)	(pcs.)
3/8	14.8	25	8.8	63	155	10
7/16	16.5	25	10	65	158	10
1/2	19	25	11.4	66	152	10
9/16	20.3	25	11.4	66	151	10
5/8	22.8	25	13	68	150	10
11/16	24.6	25	14	69	153	10

4445M (mm)	D ₁ (mm)	D ₂ (mm)	H (mm)	L (mm)	(g)	(pcs.)
10	15.3	25	8.8	63	155	10
12	17.8	25	10.5	65	151	10
13	19	25	11.4	66	152	10
14	20.3	25	11.4	66	151	10
17	24	25	14	69	150	10
19	26.5	25	15	71	170	10
21	29	25	16	72	176	5
22	30.3	25	16	72	185	5

4440T TORX® Universal Sockets TORX® Gelenk-Einsätze Douilles articulées, TORX®

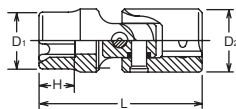

4440T (E)	D ₁ (mm)	D ₂ (mm)	H (mm)	L (mm)	(g)	(pcs.)
E10	13.2	25	8.2	62	145	10
E12	15	25	9.3	63	147	10
E14	16.3	25	10.6	65	148	10
E16	18.8	25	11.8	65	150	10
E18	20.4	25	13	67	153	10

4000-60 (PH) PH Bit Sockets Steckschlüssel für Kreuzschlitzschrauben, PH Douilles tournevis pour vis à empreinte PH

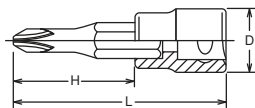

4000 (PH)	D (mm)	H (mm)	L (mm)	(g)	(pcs.)
2	22	23.5	60	65	10
3	22	23.5	60	65	10
4	22	23.5	60	67	10

4000-60 (PZ) PZ Bit Sockets Steckschlüssel für Kreuzschlitzschrauben, PZ Douilles tournevis pour vis à empreinte PZ

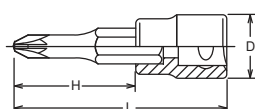

4000-60 (PZ)	D (mm)	H (mm)	L (mm)	(g)	(pcs.)
PZ2	22	23.5	60	65	10
PZ3	22	23.5	60	65	10

4005-60 Bit Sockets for Slotted Heads Steckschlüssel für Schlitzschrauben Douilles tournevis pour vis à fente

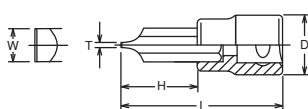



4005	T×W (mm)	D (mm)	H (mm)	L (mm)	(g)	(pcs.)
8	1.2× 8	22	23.5	60	65	10
10	1.6×10	22	23.5	60	75	10
12	2.0×12	23	23.5	60	111	10
14	2.5×14	24	23.5	60	133	10
16	2.5×16	24	23.5	60	133	10

1/2"

Hand Sockets
Hand Steckschlüssel
Douilles à main

4010M-50 / -75 / -100 / -160 4010A-60

 Inhex Bit Sockets
Steckschlüssel für Innensechskant-Schrauben
 Douilles tournevis pour vis 6-pans creux



4010M-50 (mm)	D (mm)	H (mm)	L (mm)	(g)	(pcs.)
4	22	13.5	50	61	10
5	22	13.5	50	62	10
6	22	13.5	50	64	10
7	22	13.5	50	65	10
8	22	13.5	50	66	10
9	22	13.5	50	73	10
10	22	13.5	50	75	10
12	23	13.5	50	105	10
13	24	13.5	50	120	10
14	24	13.5	50	120	10
16	25	15	50	150	10
17	25	15	50	150	10
18	27	15	50	200	5
19	27	15	50	200	5

4010M-75 (mm)	D (mm)	H (mm)	L (mm)	(g)	(pcs.)
4	22	38.5	75	69	10
5	22	38.5	75	70	10
6	22	38.5	75	72	10
7	22	38.5	75	73	10
8	22	38.5	75	74	10
9	22	38.5	75	90	10
10	22	38.5	75	92	10
12	23	38.5	75	130	10
13	24	38.5	75	150	10
14	24	38.5	75	150	10
16	25	35	75	180	10
17	25	35	75	180	10
18	27	33	75	230	5
19	27	33	75	230	5

4010M-100 (mm)	D (mm)	H (mm)	L (mm)	(g)	(pcs.)
4	22	63.5	100	77	10
5	22	63.5	100	78	10
6	22	63.5	100	80	10
7	22	63.5	100	82	10
8	22	63.5	100	84	10
9	22	63.5	100	105	10
10	22	63.5	100	109	10
12	23	63.5	100	155	10
13	24	63.5	100	180	5
14	24	63.5	100	180	5
16	25	60	100	250	5
17	25	60	100	250	5
18	27	58	100	300	5
19	27	58	100	300	5

4010M-160 (mm)	D (mm)	H (mm)	L (mm)	(g)	(pcs.)
4	22	123.5	160	103	10
5	22	123.5	160	104	10
6	22	123.5	160	106	10
7	22	123.5	160	108	10
8	22	123.5	160	110	10
10	22	123.5	160	126	10
12	23	123.5	160	180	5
14	24	123.5	160	260	5
17	25	120	160	360	5
19	27	118	160	415	5



4010A-60 (inch)	D (mm)	H (mm)	L (mm)	(g)	(pcs.)
5/32	22	23.5	60	57	10
3/16	22	23.5	60	57	10
7/32	22	23.5	60	59	10
1/4	22	23.5	60	63	10
9/32	22	23.5	60	65	10
5/16	22	23.5	60	67	10
11/32	22	23.5	60	75	10
3/8	22	23.5	60	76	10
7/16	23	23.5	60	101	10
1/2	24	23.5	60	124	10
9/16	25	20	60	127	10
5/8	25	20	60	174	10
3/4	27	18	60	220	5



RS4010M/10-L50	10 Pieces Set/Rail 300mm	(g)
4, 5, 6, 7, 8, 10, 12, 14, 17, 19		968

RS4010M/10-L75	10 Pieces Set/Rail 300mm	(g)
4, 5, 6, 7, 8, 10, 12, 14, 17, 19		1,207

RS4010A/10-L60	10 Pieces Set/Rail 300mm	(g)
3/16, 7/32, 1/4, 5/16, 3/8, 7/16, 1/2, 9/16, 5/8, 3/4		1,080

RS4010M/10-L50  Socket Set on Rail
Steckschlüsselsatz auf Schiene
RS4010M/10-L75  Jeu de douilles sur rail
RS4010A/10-L60 



4012M-43 / -60 / -75 / -100



Inhex Sockets
Steckschlüssel für Innensechskant-Schrauben ⚠
Douilles tournevis pour vis 6-pans creux

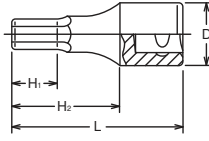

4012M-43 (mm)	D (mm)	H ₁ (mm)	H ₂ (mm)	L (mm)	(g)	(pcs.)
4	21.1	11.5	23	43	40	10
5	21.1	11.5	23	43	46	10
6	21.1	11.5	23	43	42	10
7	21.1	11.5	23	43	46	10
8	21.1	11.5	23	43	49	10
9	21.1	11.5	23	43	63	10
10	23	11.5	23	43	63	10
11	25	11.5	23	43	74	10
12	25	11.5	23	43	81	10
13	25	11.5	23	43	85	10
14	25	11.5	23	43	88	10
15	26	11.5	23	43	91	10
16	26	11.5	23	43	100	10
17	26	11.5	23	43	101	10
18	26	11.5	23	43	106	10
19	26	11.5	23	43	110	10
20	26	11.5	23	43	130	10
21	26	11.5	23	43	140	10
22	26	11.5	23	43	145	10
23	28	11.5	23	43	167	10
24	28	11.5	23	43	170	10
27	32	11.5	23	43	226	10

4012M-60 (mm)	D (mm)	H ₁ (mm)	H ₂ (mm)	L (mm)	(g)	(pcs.)
4	21.1	15.5	38	60	49	10
5	21.1	15.5	38	60	55	10
6	21.1	15.5	38	60	56	10
7	21.1	15.5	38	60	60	10
8	21.1	15.5	38	60	64	10
9	21.1	15.5	38	60	78	10
10	23	15.5	38	60	78	10
11	25	15.5	38	60	100	10
12	25	15.5	38	60	107	10
13	25	15.5	38	60	111	10
14	25	15.5	38	60	122	10
15	26	15.5	38	60	125	10
16	26	15.5	38	60	134	10
17	26	15.5	38	60	141	10
18	26	15.5	38	60	153	10
19	26	15.5	38	60	159	10
21	26	15.5	38	60	197	10
22	26	22.5	38	60	205	10
23	28	22.5	38	60	242	10
24	28	22.5	38	60	245	10

4012M-75 (mm)	D (mm)	H ₁ (mm)	H ₂ (mm)	L (mm)	(g)	(pcs.)
4	21.1	15.5	53	75	52	10
5	21.1	15.5	53	75	58	10
6	21.1	15.5	53	75	62	10
7	21.1	15.5	53	75	70	10
8	21.1	15.5	53	75	74	10
9	21.1	15.5	53	75	88	10
10	23	15.5	53	75	94	10
11	25	15.5	53	75	119	10
12	25	15.5	53	75	122	10
13	25	15.5	53	75	137	10
14	25	15.5	53	75	148	10
15	26	15.5	53	75	151	10
16	26	15.5	53	75	171	10
17	26	15.5	53	75	184	10
18	26	15.5	53	75	196	10
19	26	15.5	53	75	212	10
22	26	22.5	53	75	266	10
24	27.9	22.5	53	75	315	10

4012M-100 (mm)	D (mm)	H ₁ (mm)	H ₂ (mm)	L (mm)	(g)	(pcs.)
4	24	15.5	78	100	75	10
5	24	15.5	78	100	81	10
6	24	15.5	78	100	85	10
7	24	15.5	78	100	93	10
8	24	15.5	78	100	97	10
9	24	15.5	78	100	111	10
10	24	15.5	78	100	117	10
11	24	15.5	78	100	142	10
12	24	15.5	78	100	143	10
13	24	15.5	78	100	158	10
14	24	15.5	78	100	169	10
15	24	15.5	78	100	172	10
16	24	15.5	78	100	192	5
17	24	15.5	78	100	215	5
18	24	15.5	78	100	227	5
19	24	15.5	78	100	243	5

RS4012M/10-L60





Socket Set on Rail
Steckschlüsselsatz auf Schiene
Jeu de douilles sur rail





RS4012M/10-L60	10 Pieces set/Rail 300mm	(g)
4, 5, 6, 7, 8, 10, 12, 14, 17, 19		910



⚠ 4012M/A are for hand use only.
Do not use with a power or impact wrench.
Nicht auf Maschinenschrauben verwenden.
À ne pas utiliser sur des machines

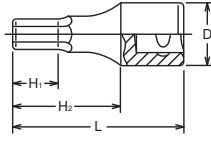

4012A-43 / -60 / -75 / -100



 Inhex Sockets
Steckschlüssel für Innensechskant-Schrauben 
Douilles tournevis pour vis 6-pans creux



4012A-43 (inch)	D (mm)	H ₁ (mm)	H ₂ (mm)	L (mm)	 (g)	 (pcs.)
5/32	21.1	11.5	23	43	40	10
3/16	21.1	11.5	23	43	46	10
7/32	21.1	11.5	23	43	42	10
1/4	21.1	11.5	23	43	43	10
9/32	21.1	11.5	23	43	46	10
5/16	21.1	11.5	23	43	49	10
11/32	21.1	11.5	23	43	63	10
3/8	23	11.5	23	43	59	10
7/16	25	11.5	23	43	74	10
1/2	25	11.5	23	43	85	10
9/16	25	11.5	23	43	88	10
5/8	26	11.5	23	43	100	10
3/4	26	11.5	23	43	110	10
7/8	26	11.5	23	43	141	10

4012A-60 (inch)	D (mm)	H ₁ (mm)	H ₂ (mm)	L (mm)	 (g)	 (pcs.)
5/32	21.1	15.5	38	60	49	10
3/16	21.1	15.5	38	60	55	10
7/32	21.1	15.5	38	60	56	10
1/4	21.1	15.5	38	60	57	10
9/32	21.1	15.5	38	60	60	10
5/16	21.1	15.5	38	60	64	10
11/32	21.1	15.5	38	60	78	10
3/8	23	15.5	38	60	74	10
7/16	25	15.5	38	60	100	10
1/2	25	15.5	38	60	111	10
9/16	25	15.5	38	60	122	10
5/8	26	15.5	38	60	134	10
3/4	26	15.5	38	60	159	10
7/8	26	22.5	38	60	202	10

4012A-75 (inch)	D (mm)	H ₁ (mm)	H ₂ (mm)	L (mm)	 (g)	 (pcs.)
5/32	21.1	15.5	53	75	52	10
3/16	21.1	15.5	53	75	58	10
7/32	21.1	15.5	53	75	62	10
1/4	21.1	15.5	53	75	65	10
9/32	21.1	15.5	53	75	70	10
5/16	21.1	15.5	53	75	74	10
11/32	21.1	15.5	53	75	88	10
3/8	23	15.5	53	75	86	10
7/16	25	15.5	53	75	119	10
1/2	25	15.5	53	75	137	10
9/16	25	15.5	53	75	148	10
5/8	26	15.5	53	75	171	10
3/4	26	15.5	53	75	212	10
7/8	26	22.5	53	75	262	10

4012A-100 (inch)	D (mm)	H ₁ (mm)	H ₂ (mm)	L (mm)	 (g)	 (pcs.)
5/32	24	15.5	78	100	75	10
3/16	24	15.5	78	100	81	10
7/32	24	15.5	78	100	85	10
1/4	24	15.5	78	100	88	10
9/32	24	15.5	78	100	93	10
5/16	24	15.5	78	100	97	10
11/32	24	15.5	78	100	111	10
3/8	24	15.5	78	100	109	10
7/16	24	15.5	78	100	142	10
1/2	24	15.5	78	100	158	10
9/16	24	15.5	78	100	169	10
5/8	24	15.5	78	100	192	5
3/4	24	15.5	78	100	243	5

RS4012A/10-L60	10 Pieces set/Rail 300mm	 (g)
3/16, 7/32, 1/4, 5/16, 3/8, 7/16, 1/2, 9/16, 5/8, 3/4		950

RS4012A/10-L60   Socket Set on Rail
Steckschlüsselsatz auf Schiene
Jeu de douilles sur rail



 4012M/A are for hand use only.
Do not use with a power or impact wrench.
Nicht auf Maschinenschrauben verwenden.
À ne pas utiliser sur des machines

Hand Sockets Hand Steckschlüssel Douilles à main

1/2"

4020-60 / -100 / -120 / -140

 XZN Bit Sockets
Steckschlüssel für XZN Schrauben
Douilles tournevis pour empreinte XZN

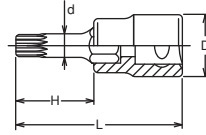



4020-60 (XZN)	D (mm)	d (mm)	H (mm)	L (mm)	(g)	(pcs.)
M 5	22	7.8	23.5	60	60	10
M 6	22	7.8	23.5	60	61	10
M 8	22	7.8	23.5	60	63	10
M10	23	11.9	23.5	60	93	10
M12	23	11.9	23.5	60	97	10
M14	24	13.9	23.5	60	105	10
M16	25	16.9	20	60	165	10
M18	25	17.9	20	60	170	10

4020-120 (XZN)	D (mm)	d (mm)	H (mm)	L (mm)	(g)	(pcs.)
M 5	22	7.8	83.5	120	86	10
M 6	22	7.8	83.5	120	87	10
M 8	22	7.8	83.5	120	89	10
M10	23	11.9	83.5	120	152	10
M12	23	11.9	83.5	120	156	10
M14	24	13.9	83.5	120	164	5

4020-100 (XZN)	D (mm)	d (mm)	H (mm)	L (mm)	(g)	(pcs.)
M 5	22	7.8	63.5	100	77	10
M 6	22	7.8	63.5	100	78	10
M 8	22	7.8	63.5	100	80	10
M10	23	11.9	63.5	100	132	10
M12	23	11.9	63.5	100	136	10
M14	24	13.9	63.5	100	144	5
M16	25	16.9	60	100	250	5
M18	27	17.9	60	100	300	5

4020-140 (XZN)	D (mm)	d (mm)	H (mm)	L (mm)	(g)	(pcs.)
M 5	22	7.8	103.5	140	95	10
M 6	22	7.8	103.5	140	96	10
M 8	22	7.8	103.5	140	98	10
M10	23	11.9	103.5	140	172	5
M12	23	11.9	103.5	140	176	5
M14	24	13.9	103.5	140	184	5

RS4020/6-L60 RS4020/6-L100

  Socket Set on Rail
Steckschlüsselsatz auf Schiene
Jeu de douilles sur rail









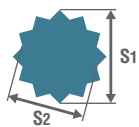



RS4020/6-L60	6 Pieces Set/Rail 150mm	(g)
M5, M6, M8, M10, M12, M14		500

RS4020/6-L100	6 Pieces Set/Rail 150mm	(g)
M5, M6, M8, M10, M12, M14		680

XZN



XZN		M4	M5	M6	M8	M10	M12	M14	M16	M18
S ₁	(ref. mm)	3.6	4.8	6.1	7.3	9.7	11.5	13.3	15.7	16.9
S ₂	(ref. mm)	3.1	4.1	5.1	6.1	8.1	9.7	11.2	13.2	14.2

	 PH	 PZ	 Slotted	 HEX	 HEX (ball point)	 Triple Square (XZN)	 TORX® (T)	 TORX® (TH)	 TORXplus® (IP)	 TORXplus® (IPR)	 Ribe-CV
1/4"	No.2000 series	No.2000(PZ) series	No.2005 series	No.2010M/A series	No.2011M series	No.2020 series	No.2025 series	No.2025(TH) series	No.2025(IP) series	No.2025(IPR) series	—
3/8"	No.3000 series	No.3000(PZ) series	No.3005 series	No.3010M/A series No.3012M/A series No.3015M series	No.3011M series	No.3020 series	No.3025 series	No.3025(TH) series	No.3025(IP) series	No.3025(IPR) series	No.3027 series
1/2"	No.4000 series	No.4000(PZ) series	No.4005 series	No.4010M/A series No.4012M/A series	—	No.4020 series	No.4025 series	—	No.4025(IP) series	—	No.4027 series

4025-60 (T)	D (mm)	H (mm)	L (mm)	(g)	(pcs.)
T15	22	23.5	60	58	10
T20	22	23.5	60	59	10
T25	22	23.5	60	60	10
T27	22	23.5	60	60	10
T30	22	23.5	60	60	10
T40	22	23.5	60	62	10
T45	22	23.5	60	64	10
T50	22	23.5	60	74	10
T55	23	23.5	60	96	10
T60	24	23.5	60	122	10
T70	24	23.5	60	135	10
T80	24	20	60	168	10

4025-100 (T)	D (mm)	H (mm)	L (mm)	(g)	(pcs.)
T20	22	73.5	100	76	10
T25	22	73.5	100	76	10
T27	22	73.5	100	77	10
T30	22	73.5	100	77	10
T40	22	73.5	100	78	10
T45	22	73.5	100	80	10
T50	22	73.5	100	98	10
T55	23	73.5	100	132	10
T60	24	73.5	100	170	5
T70	24	73.5	100	175	5

4025-140 (T)	D (mm)	H (mm)	L (mm)	(g)	(pcs.)
T20	22	103.5	140	94	10
T25	22	103.5	140	95	10
T27	22	103.5	140	95	10
T30	22	103.5	140	95	10
T40	22	103.5	140	97	10
T45	22	103.5	140	99	10
T50	22	103.5	140	129	10
T55	23	103.5	140	175	5
T60	24	103.5	140	229	5
T70	24	103.5	140	245	5
T80	24	100	140	320	5

RS4025/9-L60	9 Pieces Set/Rail 250mm	(g)
T20, T25, T27, T30, T40, T45, T50, T55, T60		700

4025-60 / -100 / -140 (T)

TORX® Bit Sockets
TORX® Bit-Steckschlüssel
Douilles tournevis, TORX®

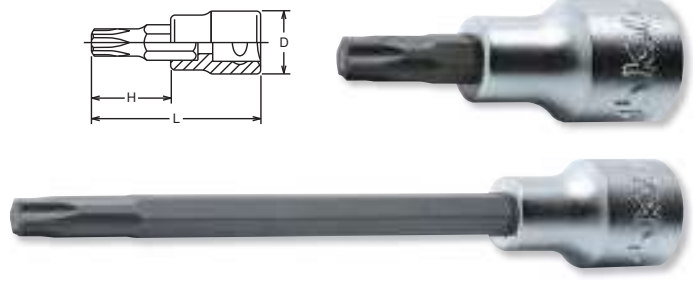

RS4025/9-L60



Socket Set on Rail
Steckschlüsselsatz auf Schiene
Jeu de douilles sur rail



TORX® (T)

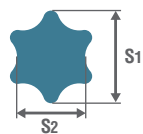

T	T8	T9	T10	T15	T20	T25	T27	T30	T40	T45	T50	T55	T60	T70	T80	T90	T100
S1 (ref. mm)	2.3	2.5	2.7	3.3	3.9	4.5	5.0	5.6	6.7	7.9	8.9	11.3	13.3	15.6	17.6	20.0	22.2
S2 (ref. mm)	1.7	1.8	2.0	2.3	2.8	3.2	3.6	4.0	4.8	5.6	6.2	8.0	9.5	11.1	12.7	14.2	15.8

4025-60	D (mm)	H (mm)	L (mm)	(g)	(pcs.)
T35	22	23.5	60	96	10

For T35 Special screws

4025-60-T35

Bit Socket
Bit-Steckschlüssel
Douille tournevis



4025-60 / -100 (IP)



TORXPLUS® Bit Sockets
TORXPLUS® Bit-Steckschlüssel
Douilles tournevis, TORXPLUS®



4025-60 (IP)	D (mm)	H (mm)	L (mm)	(g)	(pcs.)
20IP	22	23.5	60	60	10
25IP	22	23.5	60	60	10
27IP	22	23.5	60	60	10
30IP	22	23.5	60	60	10
40IP	22	23.5	60	60	10
45IP	22	23.5	60	64	10
50IP	22	23.5	60	74	10
55IP	23	23.5	60	96	10
60IP	24	23.5	60	122	10
70IP	24	23.5	60	170	10

RS4025/9-IP



Socket Set on Rail
Steckschlüsselsatz auf Schiene
Jeu de douilles sur rail



4025-100 (IP)	D (mm)	H (mm)	L (mm)	(g)	(pcs.)
40IP	22	63.5	100	79	10
45IP	22	63.5	100	81	10
50IP	22	63.5	100	100	10
55IP	23	63.5	100	133	10
60IP	24	63.5	100	172	5
70IP	25	63.5	100	241	5

RS4025/9-IP	9 Pieces set/Rail 250mm	(g)
20IP, 25IP, 27IP, 30IP, 40IP, 45IP, 50IP, 55IP, 60IP		700

TORXPLUS® (IP)

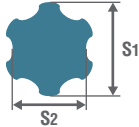

IP	8IP	9IP	10IP	15IP	20IP	25IP	27IP	30IP	40IP	45IP	50IP	55IP	60IP	70IP
S ₁ (ref. mm)	2.3	2.5	2.7	3.3	3.9	4.5	5.0	5.6	6.7	7.9	8.9	11.3	13.3	15.6
S ₂ (ref. mm)	1.7	1.8	2.0	2.3	2.8	3.2	3.6	4.0	4.8	5.6	6.2	8.0	9.5	11.1

4027-60 / -100 / -140



Bit Sockets for Ribbe Screws
Steckschlüsselklingen für Ribbe Schrauben
Douilles tournevis pour écrous profil Ribbe



4027-60	D (mm)	H (mm)	L (mm)	(g)	(pcs.)
M 5	22	23.5	60	60	10
M 6	22	23.5	60	62	10
M 7	22	23.5	60	63	10
M 8	22	23.5	60	64	10
M 9	22	23.5	60	70	10
M10	22	23.5	60	74	10
M12	23	23.5	60	96	10
M13	24	23.5	60	116	10
M14	24	23.5	60	122	10
M16	24	25	60	135	10

4027-100	D (mm)	H (mm)	L (mm)	(g)	(pcs.)
M 5	22	63.5	100	67	10
M 6	22	63.5	100	68	10
M 7	22	63.5	100	75	10
M 8	22	63.5	100	81	10
M 9	22	63.5	100	90	10
M10	22	63.5	100	101	10
M12	23	63.5	100	134	10
M13	24	63.5	100	155	5
M14	24	63.5	100	173	5
M16	24	60	100	241	5

RS4027/7-L60



Socket Set on Rail
Steckschlüsselsatz auf Schiene
Jeu de douilles sur rail



4027-140	D (mm)	H (mm)	L (mm)	(g)	(pcs.)
M 8	22	103.5	140	98	10
M10	22	103.5	140	127	10
M12	23	103.5	140	171	5
M14	24	103.5	140	226	5
M16	24	100	140	320	5

RS4027/7-L60	7 Pieces set/Rail 200mm	(g)
M5, M6, M8, M10, M12, M14, M16		600

Ribbe CV

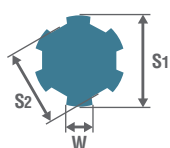

CV	M5	M6	M7	M8	M9	M10	M12	M13	M14	M16
W (ref. mm)	1.2	1.3	1.4	1.8	2.0	2.3	2.6	3.1	3.2	3.6
S ₁ (ref. mm)	5.0	6.0	7.0	8.0	9.0	10.0	12.0	13.0	14.0	16.0
S ₂ (ref. mm)	3.8	4.5	5.0	6.0	7.1	7.4	9.0	11.0	10.4	11.9

4110M (mm)	D (mm)	H (mm)	L (mm)	(g)	(pcs.)
8	24	10	32	57	10
10	24	10	32	62	10
10.5	24	10	32	64	10
12	24	10	32	64	10
13	24	10	32	66	10
13.5	24	10	32	67	10
19	25	15	37	101	10
20	26	15	37	114	10

4110A (inch)	D (mm)	H (mm)	L (mm)	(g)	(pcs.)
3/8	24	10	32	62	10
1/2	24	10	32	64	10

4101	T×W (mm)	D (mm)	L (mm)	(g)	(pcs.)
1	2.7×18.6	22	40	59	10
2	3.7×24	24	40	79	10
3	3.7×30	30	40	128	10

4137	D ₁ (mm)	D ₂ (mm)	L (mm)	(g)	(pcs.)
4137	13	22	38	53	10

For DIN3126 C6.3 Bits
Für DIN3126 C6.3 Bits
Pour DIN3126 C6.3 Embouts

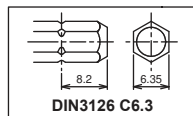

4138	D ₁ (mm)	D ₂ (mm)	L (mm)	(g)	(pcs.)
4138	16	22	38	62	10

For DIN3126 C8 Bits
Für DIN3126 C8 Bits
Pour DIN3126 C8 Embouts

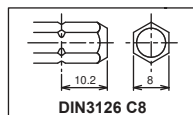

4110M / 4110A

4-point Male Sockets
Öldienst-Steckschlüssel, Vierkant
Douilles mâles 4-pans

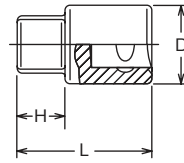

4101

Sockets for Slotted Heads
Steckschlüssel für Schlitzschrauben
Douilles tournevis pour vis à fente

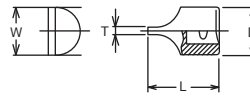

4137

Bit Holder
Klingenhalter
Porte-embouts

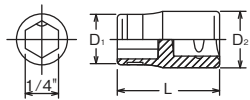

4138

Bit Holder
Klingenhalter
Porte-embouts

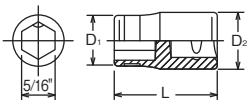

Hand Sockets Hand Steckschlüssel Douilles à main

1/2"

Z-SERIES
HAND
TITANIUM
SCREWDRIVERS ACCESSORIES
IMPACT
SLEEVE-DRIVE
PROTECTOR
INDUSTRIAL
AUTOMOTIVE
MOTORCYCLE
CONSTRUCTION
SPARE PART

3749S-1/2 Reversible Ratchet Short
Knarre, verstellbar
Cliquet, réversible



* Renewal Kits → 3749SRK-1/2 → P306

3749SB-1/2 Reversible Ratchet short with quick release button
Knarre, verstellbar mit Entriegelungsknopf
Cliquet, réversible avec bouton de débrayage

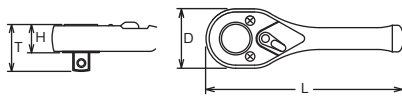

* Renewal Kits → 3749SRK-1/2 → P306

	D (mm)	T (mm)	H (mm)	L (mm)	(g)	(pce.)
3749S-1/2	34	29	14.4	110	200	5
3749SB-1/2	34	29	14.4	110	200	5

⚠ Reversible Ratchet with quick release button has less strength compared with normal ratchet due to the technical design. Make sure to use the ratchet correctly.

4752J Reversible Ratchet
Knarre, verstellbar
Cliquet, réversible



* Renewal Kits → 4752RK → P307

[L/R Marking]



A pointer and L/R markings on the ratchet head indicate the turning direction. The reduced diameter of the head allows easier access in tight spots.

Eine L/R Markierung auf dem Knarrenkopf zeigt die gerade eingestellte Drehrichtung an. Der geringe Kopfdurchmesser erleichtert das Arbeiten auch an schwer zugänglichen Stellen.

Un marquage L/R sur la tête de cliquet indique le sens de rotation. Le diamètre de tête réduit et facilite le travail dans les endroits difficilement accessibles.

4752N Reversible Ratchet
Knarre, verstellbar
Cliquet, réversible

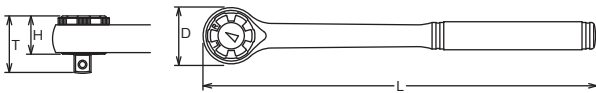

	D (mm)	T (mm)	H (mm)	L (mm)	(g)	(pce.)
4752J	35	38.8	24.5	250	470	1
4752N	35	38.8	24.5	250	480	1

GEAR TEETH



4749series



4753series



4750series



4752series



4774series





* Renewal Kits → 4750RK → P306

4750J Reversible Ratchet
Knarre, verstellbar
Cliquet, réversible



* Renewal Kits → 4750RK → P306

4750P Reversible Ratchet
Knarre, verstellbar
Cliquet, réversible



* Renewal Kits → 4750RK → P306

4750N Reversible Ratchet
Knarre, verstellbar
Cliquet, réversible



	D (mm)	T (mm)	H (mm)	L (mm)	(g)	(pce.)
4750J	38	35.9	21.3	250	508	1
4750P	38	35.9	21.3	250	553	1
4750N	38	35.9	21.3	250	548	1

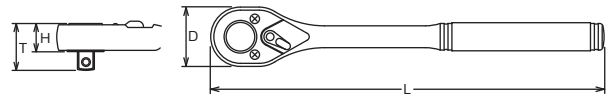

* Renewal Kits → 4750BRK → P306

4750JB Reversible Ratchet with quick release button
Knarre, verstellbar mit Entriegelungsknopf
4750PB Cliquet, réversible avec bouton de débrayage
4750NB



	D (mm)	T (mm)	H (mm)	L (mm)	(g)	(pce.)
4750JB	38	35.9	21.3	250	508	1
4750PB	38	35.9	21.3	250	553	1
4750NB	38	35.9	21.3	250	548	1

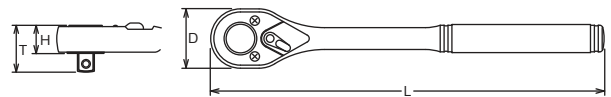

⚠ Reversible Ratchet with quick release button has less strength compared with normal ratchet due to the technical design. Make sure to use the ratchet correctly.

[4750 series]



Two dogs are set in the same axis and the three teeth hold the ratchet gear. The enlarged contact area produces an about 10% higher torque value and the S.O.D.H system provides smooth and light movements.

Die scharnierartig eingelagerten Sperrklinken haben jetzt jeweils drei Zähne im Eingriff. Die dadurch vergrößerte Greiffläche erhöht das maximale Drehmoment um ca. 10%. Auch diese Knarre besticht durch ihren leichten und geschmeidigen Lauf.

Les deux rochets étant placés sur le même axe, les trois dents de l'engrenage sont engagées en permanence. Ce système assure une augmentation de 10% du couple maximum admissible. Ce cliquet se caractérise également par son fonctionnement souple et sans à-coup.

Hand Sockets Hand Steckschlüssel Douilles à main

1/2"

Z-SERIES
HAND
TITANIUM
SCREWDRIVERS ACCESSORIES
IMPACT
SLEEVE-DRIVE
PROTECTOR
INDUSTRIAL
AUTOMOTIVE
MOTORCYCLE
CONSTRUCTION
SPARE PART

4753J Reversible Ratchet
Knarre, verstellbar
Cliquet, réversible



* Renewal Kits → 4753RK → P306

4753P Reversible Ratchet
Knarre, verstellbar
Cliquet, réversible



* Renewal Kits → 4753RK → P306

4753N Reversible Ratchet
Knarre, verstellbar
Cliquet, réversible



* Renewal Kits → 4753RK → P306

D4753J Reversible Ratchet
Knarre, verstellbar
Cliquet, réversible



* Renewal Kits → 4753RK → P306

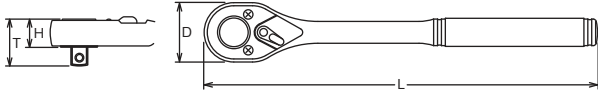

	D (mm)	T (mm)	H (mm)	L (mm)	(g)	(pce.)
4753J	38	36.2	21.6	250	545	1
4753P	38	36.2	21.6	250	570	1
4753N	38	36.2	21.6	250	595	1
D4753J	38	36.2	21.6	250	510	1

4753JB Reversible Ratchet with quick release button
4753PB Knarre, verstellbar mit Entriegelungsknopf
4753NB Cliquet, réversible avec bouton de débrayage



* Renewal Kits → 4753BRK → P306

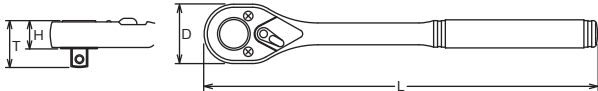

	D (mm)	T (mm)	H (mm)	L (mm)	(g)	(pce.)
4753JB	38	36.2	21.6	250	545	1
4753PB	38	36.2	21.6	250	570	1
4753NB	38	36.2	21.6	250	595	1

Reversible Ratchet with quick release button has less strength compared with normal ratchet due to the technical design. Make sure to use the ratchet correctly.



Reversible Ratchet with Quick Release Button :
Sockets and accessories are safely locked. By pushing the button the sockets or extension bars are released from the ratchet.

Umstellbare Knarre mit Entriegelungsknopf :
Steckschlüssel und Zubehörteile werden sicher und fest gehalten. Bei Drücken des Knopfes lösen sich die Teile.

Cliquet réversible avec bouton de débrayage :
Les douilles et accessoires ne peuvent plus tomber. Une pression du pouce sur le bouton suffit pour les libérer.



* Renewal Kits → 4749RK → P306

4749J-380 Reversible Ratchet (long)
Verstellbare Knarre, lang
4749N-380 Cliquet réversible, long



	D (mm)	T (mm)	H (mm)	L (mm)	(g)	(pce.)
4749J-380	44.6	33	18.4	380	743	1
4749N-380	44.6	33	18.4	380	753	1

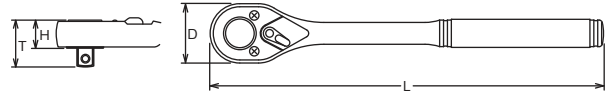

* Renewal Kits → 4753RK → P306

4753P-410 Reversible Ratchet (long) ⚠
Verstellbare Knarre, lang
Cliquet réversible, long



	D (mm)	T (mm)	H (mm)	L (mm)	(g)	(pce.)
4753P-410	38	36.2	21.6	410	790	1

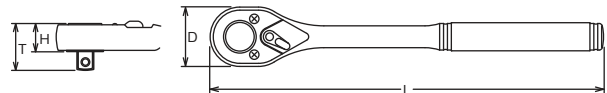

⚠ 4753P-410 have longer handle than standard, and can be loaded to excessive torque value. In the interest of your own safety always apply load evenly and progressively to avoid breakage and possible injury.



* Renewal Kits → 4753RK → P306

4774J Flexible Ratchet, reversible
Gelenk-Knarre, verstellbar
4774P Cliquet, articulé, réversible
4774N

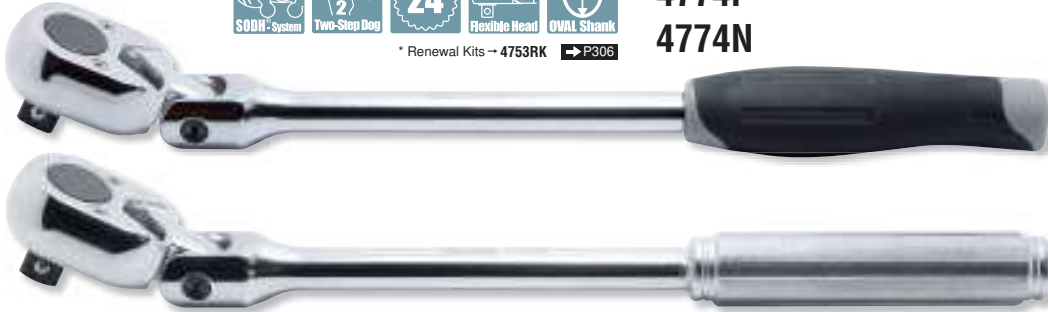

	D (mm)	T (mm)	H (mm)	L (mm)	(g)	(pce.)
4774J	38	36.2	21.6	330	685	1
4774P	38	36.2	21.6	330	700	1
4774N	38	36.2	21.6	330	700	1

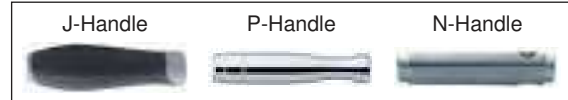
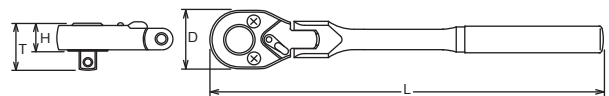

* Renewal Kits → 4753RK → P306

4774P-450 Flexible Ratchet, reversible ⚠
Gelenk-Knarre, verstellbar
Cliquet, articulé, réversible



	D (mm)	T (mm)	H (mm)	L (mm)	(g)	(pce.)
4774P-450	38	36.2	21.6	450	790	1

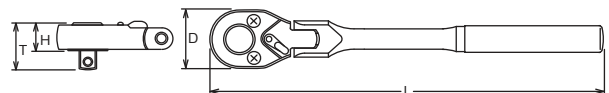

⚠ 4774P-450 has longer handle than standard, and can be loaded to excessive torque value. In the interest of your own safety always apply load evenly and progressively to avoid breakage and possible injury.

Hand Sockets Hand Steckschlüssel Douilles à main

1/2"

Z-SERIES
HAND
TITANIUM
SCREWDRIVERS ACCESSORIES
IMPACT
SLEEVE-DRIVE
PROTECTOR
INDUSTRIAL
AUTOMOTIVE
MOTORCYCLE
CONSTRUCTION
SPARE PART

4774JB Flexible Ratchet, reversible with quick release button ⚠
4774PB Gelenk-Knarre, verstellbar mit Entriegelungsknopf
4774NB Cliquet, articulé, réversible avec bouton de débrayage



* Renewal Kits → 4753BRK → P306

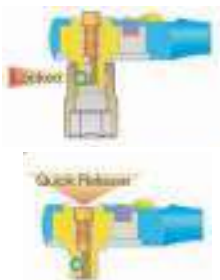
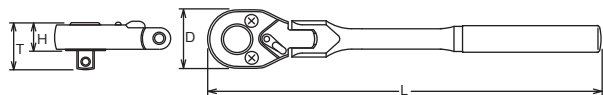

	D (mm)	T (mm)	H (mm)	L (mm)	(g)	(pcs.)
4774JB	38	36.2	21.6	330	685	1
4774PB	38	36.2	21.6	330	700	1
4774NB	38	36.2	21.6	330	700	1

⚠ Reversible Ratchet with quick release button has less strength compared with normal ratchet due to the technical design. Make sure to use the ratchet correctly.

Reversible Ratchet with Quick Release Button :

Sockets and accessories are safely locked. By pushing the button the sockets or extension bars are released from the ratchet.

Umstellbare Knarre mit Entriegelungsknopf :

Steckschlüssel und Zubehörteile werden sicher und fest gehalten. Bei Drücken des Knopfes lösen sich die Teile.

Cliquet réversible avec bouton de débrayage :

Les douilles et accessoires ne peuvent plus se libérer. Une pression du pouce sur le bouton suffit pour les extraire.

4755 Ratchet Adaptor
Aufsteckknarre
Cliquet adaptable

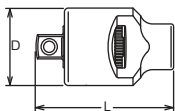

* Renewal Kits → 4755RK → P307

	D (mm)	L (mm)	(g)	(pcs.)
4755	33.5	65	270	5

4756 Quick Spinner
Rändel-Drehscheibe
Lanceur

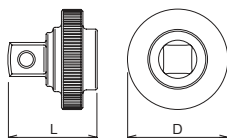

	D (mm)	L (mm)	(g)	(pcs.)
4756	38	34.5	95	10

4768J-380 / -450 / -600 Hinge Handles
Gelenkgriffe
Poignées articulées ⚠



* Renewal Kits → 4768RK → P309



4768P-380 / -450 / -600 Hinge Handles
Gelenkgriffe
Poignées articulées ⚠



* Renewal Kits → 4768RK → P309

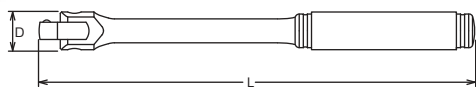

⚠ 4768-450 has longer handle than standard, and can be loaded to excessive torque value. Please use carefully.

	D (mm)	L (mm)	(g)	(pcs.)
4768J-380	28	380	600	1
4768J-450	28	450	690	1
4768J-600	28	600	1120	1
4768P-380	28	380	665	2
4768P-450	28	450	748	2
4768P-600	28	600	1170	1

	D (mm)	L (mm)	(g)	(pcs.)
4760-35	24	35	56	10
4760-50	24	50	92	10
4760-75	24	75	138	10
4760-100	24	100	158	5
4760-125	24	125	194	5
4760-150	24	150	266	5
4760-200	24	200	295	5
4760-250	24	250	358	5
4760-300	24	300	492	2
4760-400	24	400	650	1
4760-500	24	500	808	1
4760-600	24	600	968	1
4760-900	24	900	1430	1
4760-1000	24	1000	1593	1

4760 Extension Bars Verlängerungen Rallonges

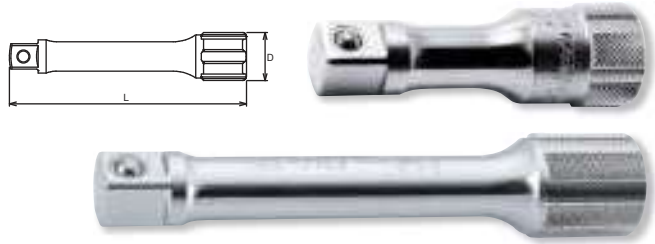

PK4760/5 5 Pieces Set/△=1,050g
PLASTIC TRAY

Extension Bars
4760 Extension Bars
50, 75, 125, 150, 250

Rotation and general handling of extensions with oily hands is greatly improved with the **Kokon** developed 6 point knurling. Also the **Kokon** 6 point knurling stops the extensions from rolling around the work area.

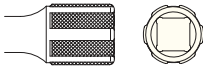

Durch die von **Kokon** entwickelte 6 fache Rändelung wird die Handhabung deutlich erleichtert. Außerdem wird das Herumrollen der Verlängerungen wirksam verhindert.

La manipulation des rallonges est grandement facilitée par le profil moleté développé par **Kokon**. Ce même profil empêche le roulement intempestif des rallonges sur le plan de travail.

PK4760/5 Extension Bars in Plastic Box Verlängerungen in Kunststoff-Kassette Rallonges en boîte plastique



	D (mm)	L (mm)	(g)	(pcs.)
4763-50	24	50	95	10
4763-75	24	75	111	10
4763-125	24	125	157	5
4763-150	24	150	181	5
4763-250	24	250	357	5
4763-400	24	400	650	1

4763 Wobble-Fix Extension Bars Winkel-Verlängerungen Rallonges angulaires

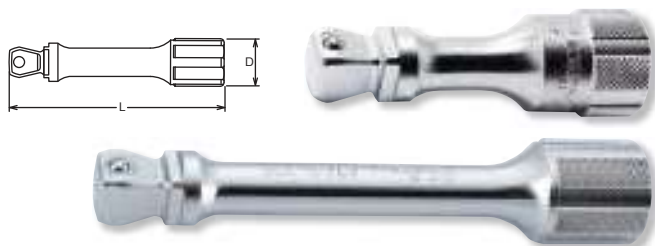

⚠ The Wobble-Fix Extension Bar has less strength than normal extension bar due to it's specific design with a reduced square drive. Make sure to use it correctly.



PK4763/5 5 Pieces Set/△=950g
PLASTIC TRAY

Extension Bars
4763 Wobble-Fix Extension Bars
50, 75, 125, 150, 250

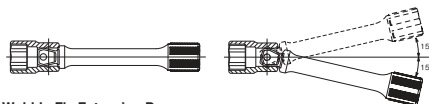

Wobble-Fix Extension Bar

Two way usage

- In a fixed position, as a normal extension bar
- In a half-fixed position, as a flexible extension bar providing a 15° angle operation

Winkel-Verlängerungen

Winkelverlängerungen lassen sich in zwei Einstellungen verwenden

- voll eingesteckt und starr,
- halb eingesteckt, mit einem Arbeitswinkel von 15°.

Rallonges angulaires

Deux utilisations possibles

- comme rallonge normale, dans une position fixe
- comme une rallonge angulaire avec une possibilité d'inclinaison jusqu'à 15°

PK4763/5 Wobble-Fix Extension Bars in Plastic Box Winkel Verlängerungen in Kunststoff-Kassette Rallonges angulaires en boîte plastique



Hand Sockets
Hand Steckschlüssel
Douilles à main

1/2"

Z-SERIES
HAND
TITANIUM
SCREWDRIVERS ACCESSORIES
IMPACT
SLEEVE-DRIVE
PROTECTOR
INDUSTRIAL
AUTOMOTIVE
MOTORCYCLE
CONSTRUCTION
SPARE PART

4770 Universal Joint
Gelenk-Einsatz
Cardan universel

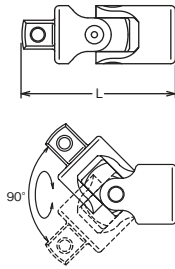

	L (mm)	(g)	(pcs.)
4770	62.4	150	10

4771 Universal Joint
Gelenk-Einsatz
Joint articulé

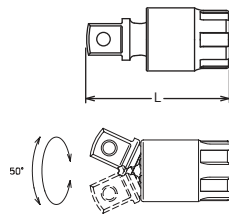

	L (mm)	(g)	(pcs.)
4771	57.7	113	10

4780-400 Speed Handle
Winde
Vilebrequin

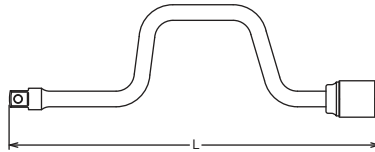

	L (mm)	(g)	(pce.)
4780	400	644	1

4781N-450 Flexible Speed Handle
Gelenkgriff-Winde
Vilebrequin

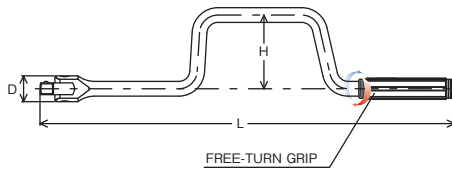

* Renewal Kits → 4768RK → P306

	D (mm)	H (mm)	L (mm)	(g)	(pce.)
4781N-450	28	80	450	1000	1

4785 T-Handle
T-Griff
Poignée coulissante



	L (mm)	(g)	(pcs.)
4785	300	410	2

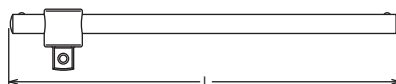

1/2"

Hand Sockets
Hand Steckschlüssel
Douilles à main



4747

L-Handle
L-Griff
Poignées en L



	L ₁ (mm)	L ₂ (mm)	(g)	(pcs.)
4747	263	53	470	1

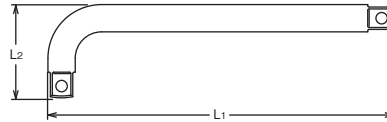

4788-250 / -300 / -450 ⚠

L-Handles
L-Griffe
Poignées en L



	L ₁ (mm)	L ₂ (mm)	(g)	(pcs.)
4788-250	250	53	417	2
4788-300	300	53	503	1
4788-450	450	53	745	1

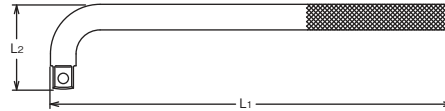

⚠ 4788-450 have longer handle than standard, and can be loaded to excessive torque value. In the interest of your own safety always apply load evenly and progressively to avoid breakage and possible injury.

	(sq.)	(sq.)	L (mm)	(g)	(pcs.)
4433A-35	1/2"	3/8"	35	50	10
4433A-75	1/2"	3/8"	75	120	10
4433A-125	1/2"	3/8"	125	164	5
4433A-250	1/2"	3/8"	250	275	5
4433A-600	1/2"	3/8"	600	530	1

Items in this catalogue marked ⚠ can be loaded to torque values which may cause breakage. In the interest of your own safety always apply load evenly and progressively to avoid breakage and possible injury.

Die mit ⚠ gekennzeichneten Artikel können bei Überbelastungen zu Bruch gehen. Aus Gründen Ihrer Sicherheit, sollten die betreffenden Werkzeuge nie ruckartig sondern nach und nach belastet werden, um Bruch und damit verbundene, mögliche Verletzungen zu vermeiden.

Il est possible d'appliquer aux articles marqués ⚠ des couples de serrage susceptibles d'occasionner leur rupture. Pour votre propre sécurité, veuillez toujours appliquer la charge d'une manière uniforme et progressive. Ceci pour éviter ruptures et accidents.

4433A

Adaptors
Verbindungsstücke
Réducteurs

Warranty 290Nm
Garantie 290Nm
Garantie 290Nm

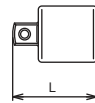

4466A

Adaptor
Verbindungsstück
Réducteurs

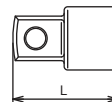

	(sq.)	(sq.)	L (mm)	(g)	(pcs.)
4466A	1/2"	3/4"	42	108	10

Z-SERIES
HAND
TITANIUM
ACCESSORIES
SCREWDRIVERS
IMPACT
SLEEVE-DRIVE
PROTECTOR
INDUSTRIAL
AUTOMOTIVE
MOTORCYCLE
CONSTRUCTION
SPARE PART

Hand Sockets
Hand Steckschlüssel
Douilles à main **1/2"**

Z-SERIES
HAND
TITANIUM
SCREWDRIVERS
ACCESSORIES
IMPACT
SLEEVE-DRIVE
PROTECTOR
INDUSTRIAL
AUTOMOTIVE
MOTORCYCLE
CONSTRUCTION
SPARE PART

4223M-01 Socket Sets
Steckschlüssel Sätze
4223M-06 Jeux de clés à douilles



4223M-01 15 Pieces Set/△=2,600g
4223M-06 15 Pieces Set/△=2,600g

METAL CASE:W415×H120×T50mm

Sockets		Accessories	
(4223M-01)			4753J
4401M 6-pt. Sockets 10, 11, 12, 13, 14, 15, 16, 17, 18, 19, 21, 22			4760-125
(4223M-06)			4770
4406M 12-pt. Sockets 10, 11, 12, 13, 14, 15, 16, 17, 18, 19, 21, 22			

4238AM Socket Sets
Steckschlüssel Sätze
Jeux de clés à douilles



4238AM 38 Pieces Set/△=8,050g

METAL CASE:W446×H266×T50mm

Sockets		Accessories	
4405M 12-pt. Sockets 10, 11, 12, 13, 14, 15, 16, 17, 18, 19, 21, 22, 23, 24, 26, 27, 30, 32			4753N
4405A 12-pt. Sockets 3/8, 7/16, 1/2, 9/16, 5/8, 11/16, 3/4, 13/16, 7/8, 15/16, 1.1/16, 1.1/8, 1.1/4			4760-125
4300C Spark Plug Socket 20.8			4760-250
			4770
			4780
			4785

S4240M-01 Display Stands
S4240A-00 Ausstellungsstände
S4240M-06 Présentoirs
S4240A-05



S4240M-01 4401M 117 Pieces Set/△=13,000g
S4240M-06 4406M 117 Pieces Set/△=13,000g

DISPLAY STAND:W510×H150×T230mm

Sockets		
10mm:9pcs	16mm:9pcs	24mm:6pcs
11mm:9pcs	17mm:8pcs	27mm:5pcs
12mm:9pcs	19mm:7pcs	30mm:5pcs
13mm:9pcs	21mm:7pcs	32mm:4pcs
14mm:9pcs	22mm:6pcs	
15mm:9pcs	23mm:6pcs	





S4240A-00 4400A 103 Pieces Set/△=13,000g
S4240A-05 4405A 103 Pieces Set/△=13,000g

DISPLAY STAND:W510×H150×T230mm

Sockets		
3/8" :9pcs	11/16":8pcs	1" :5pcs
7/16":9pcs	3/4" :7pcs	1.1/16":5pcs
1/2" :9pcs	13/16":7pcs	1.1/8" :5pcs
9/16":9pcs	7/8" :6pcs	1.3/16":5pcs
5/8" :9pcs	15/16":6pcs	1.1/4" :4pcs

4241M-01	28 Pieces Set/△=6,500g
4241M-06	28 Pieces Set/△=6,500g
4241M-10	28 Pieces Set/△=6,500g

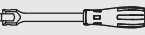
METAL CASE:W446×H266×T50mm

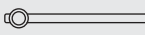
Sockets	Accessories
(4241M-01) 4401M 6-pt. Sockets 10, 11, 12, 13, 14, 15, 16, 17, 18, 19, 20, 21, 22, 23, 24, 25, 26, 27, 28, 29, 30, 32	 4753J  4760-125  4760-250  4768J-380
(4241M-06) 4406M 12-pt. Sockets 10, 11, 12, 13, 14, 15, 16, 17, 18, 19, 20, 21, 22, 23, 24, 25, 26, 27, 28, 29, 30, 32	 4770  4785
(4241M-10) 4410M Surface Drive Sockets 10, 11, 12, 13, 14, 15, 16, 17, 18, 19, 20, 21, 22, 23, 24, 25, 26, 27, 28, 29, 30, 32	







4241M-01 4241M-06 4241M-10

Socket Sets
Steckschlüssel Sätze
Jeux de clés à douilles

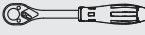

4241A-00	19 Pieces Set/△=4,900g
4241A-05	19 Pieces Set/△=4,900g

METAL CASE:W445×H190×T50mm

Sockets	Accessories
(4241A-00) 4400A 6-pt. Sockets 3/8, 7/16, 1/2, 9/16, 5/8, 11/16, 3/4, 13/16, 7/8, 15/16, 1.1/16, 1.1/8, 1.1/4	 4753J  4760-125  4760-250  4768J-380
(4241A-05) 4405A 12-pt. Sockets 3/8, 7/16, 1/2, 9/16, 5/8, 11/16, 3/4, 13/16, 7/8, 15/16, 1.1/16, 1.1/8, 1.1/4	 4770  4785



4241A-00 4241A-05

Socket Sets
Steckschlüssel Sätze
Jeux de clés à douilles

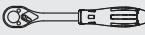

4249M-01	20 Pieces Set/△=4,800g
4249M-06	20 Pieces Set/△=4,800g

METAL CASE:W445×H190×T50mm

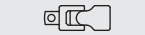
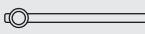
Sockets	Accessories
(4249M-01) 4401M 6-pt. Sockets 10, 11, 12, 13, 14, 15, 16, 17, 18, 19, 21, 22, 24, 27, 30	 4753J  4760-125  4760-250
(4249M-06) 4406M 12-pt. Sockets 10, 11, 12, 13, 14, 15, 16, 17, 18, 19, 21, 22, 24, 27, 30	 4770  4785



4249M-01 4249M-06

Socket Sets
Steckschlüssel Sätze
Jeux de clés à douilles

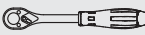
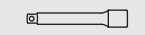
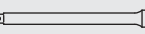

4250M-01	18 Pieces Set/△=4,700g
4250M-06	18 Pieces Set/△=4,700g
4250M-10	18 Pieces Set/△=4,700g

METAL CASE:W445×H190×T50mm

Sockets	Accessories
(4250M-01) 4401M 6-pt. Sockets 10, 11, 12, 13, 14, 15, 17, 19, 22, 24, 27, 30, 32	 4753J  4760-125  4760-250
(4250M-06) 4406M 12-pt. Sockets 10, 11, 12, 13, 14, 15, 17, 19, 22, 24, 27, 30, 32	 4770  4785
(4250M-10) 4410M Surface Drive Sockets 10, 11, 12, 13, 14, 15, 17, 19, 22, 24, 27, 30, 32	

4250M-01 4250M-06 4250M-10

Socket Sets
Steckschlüssel Sätze
Jeux de clés à douilles



Hand Sockets
Hand Steckschlüssel 1/2"
Douilles à main

Z-SERIES
HAND
TITANIUM
SCREWDRIVERS ACCESSORIES
IMPACT
SLEEVE-DRIVE
PROTECTOR
INDUSTRIAL
AUTOMOTIVE
MOTORCYCLE
CONSTRUCTION
SPARE PART

4251M-01 Socket Sets
Steckschlüssel Sätze
Jeux de clés à douilles
4251M-06
4251M-10
4251A-00
4251A-05



4251M-01	22 Pieces Set/⚖️=3,200g
4251M-06	22 Pieces Set/⚖️=3,200g
4251M-10	22 Pieces Set/⚖️=3,200g
4251A-00	18 Pieces Set/⚖️=2,700g
4251A-05	18 Pieces Set/⚖️=2,700g

METAL CASE:W330×H68×T48mm

Sockets	
(4251M-01) 4401M 6-pt. Sockets	10, 11, 12, 13, 14, 15, 16, 17, 18, 19, 20, 21, 22, 23, 24, 25, 26, 27, 28, 29, 30, 32
(4251M-06) 4406M 12-pt. Sockets	
(4251M-10) 4410M Surface Drive Sockets	
(4251A-00) 4400A 6-pt. Sockets	3/8, 7/16, 1/2, 9/16, 19/32, 5/8, 21/32, 11/16, 3/4, 25/32, 13/16, 7/8, 15/16, 1, 1.1/16, 1.1/8, 1.3/16, 1.1/4
(4251A-05) 4405A 12-pt. Sockets	

4252M-01 Socket Sets
Steckschlüssel Sätze
Jeux de clés à douilles
4252M-06
4252M-10



4252M-01	13 Pieces Set/⚖️=1,200g
4252M-06	13 Pieces Set/⚖️=1,200g
4252M-10	13 Pieces Set/⚖️=1,200g

METAL CASE:W168×H60×T42mm

Sockets	
(4252M-01) 4401M 6-pt. Sockets	10, 11, 12, 13, 14, 15, 16, 17, 18, 19, 20, 21, 22
(4252M-06) 4406M 12-pt. Sockets	
(4252M-10) 4410M Surface Drive Sockets	

4254 Socket Sets
Steckschlüssel Sätze
Jeux de clés à douilles



4254	12 Pieces Set/⚖️=1,070g
------	-------------------------

METAL CASE:W215×H80×T47mm

Sockets		Accessories	
3/8"	3425- E6, E8		4763-50
1/2"	4425- E10, E12, E14		4433A-35
3/8"	3325- E6, E8		
1/2"	4325- E10, E12, E14		

4262M-01 Socket Sets
Steckschlüssel Sätze
Jeux de clés à douilles
4262M-06
4262M-10



4262M-01	20 Pieces Set/⚖️=4,400g
4262M-06	20 Pieces Set/⚖️=4,400g
4262M-10	20 Pieces Set/⚖️=4,400g

METAL CASE:W445×H190×T50mm

Sockets		Accessories	
(4262M-01) 4401M 6-pt. Sockets	8, 10, 11, 12, 13, 14, 15, 16, 17, 18, 19, 21, 22, 24, 27		4753J
(4262M-06) 4406M 12-pt. Sockets	8, 10, 11, 12, 13, 14, 15, 16, 17, 18, 19, 21, 22, 24, 27		4760-125
(4262M-10) 4410M Surface Drive Sockets	8, 10, 11, 12, 13, 14, 15, 16, 17, 18, 19, 21, 22, 24, 27		4760-250
			4770
			4785

4272AM-01		29 Pieces Set/△=5,000g	
4272AM-06		29 Pieces Set/△=5,000g	
METAL CASE:W445×H190×T50mm			
Sockets		Accessories	
(4272AM-01)			
○	4401M 6-pt. Sockets 10, 11, 12, 13, 14, 15, 16, 17, 18, 19, 21, 22, 24		4753J
			4760-125
			4760-250
			4770
			4785
(4272AM-06)			
○	4406M 12-pt. Sockets 10, 11, 12, 13, 14, 15, 16, 17, 18, 19, 21, 22, 24		
○	4405A 12-pt. Sockets 3/8, 7/16, 1/2, 9/16, 5/8, 11/16, 3/4, 13/16, 7/8, 15/16, 1		

4272AM-01 4272AM-06

Socket Sets
Steckschlüssel Sätze
Jeux de clés à douilles



4275		24 Pieces Set/△=5,340g	
METAL CASE:W445×H190×T50mm			
Sockets		Accessories	
○	4406M 12-pt. Sockets 10, 11, 12, 13, 14, 15, 16, 17, 18, 19, 21, 22, 24		4750J
			4760-125
			4760-250
			4768J-380
			4770
			4785
○	4300C Spark Plug Sockets 16, 20.8		
○	4300M Wheel Nut Sockets 17(L60), 19(L60), 21(L60)		

4275

Socket Sets
Steckschlüssel Sätze
Jeux de clés à douilles



4276		17 Pieces Set/△=2,890g	
METAL CASE:W370×H150×T50mm			
Sockets		Accessories	
●	4010M.50 Bit Sockets 6, 7, 8, 10, 12, 14		4752J
●	4025.60 TORX® Bit Sockets T20, T25, T27, T30, T40, T45, T50, T55, T60		4763-125

4276

Socket Sets
Steckschlüssel Sätze
Jeux de clés à douilles



4277		27 Pieces Set/△=5,660g	
METAL CASE:W445×H190×T50mm			
Sockets		Accessories	
○	4406M 12-pt. Sockets 10, 12, 13, 14, 15, 16, 17, 18, 19, 21, 22, 24		4750J
			4760-125
			4768J-380
○	4305M 12-pt. Deep Sockets 10, 12, 13, 14, 15, 16, 17, 18, 19, 21, 22, 24		

4277

Socket Sets
Steckschlüssel Sätze
Jeux de clés à douilles



6400M / 6400A

6-point Sockets
6-kant Steckschlüssel
Douilles 6-pans

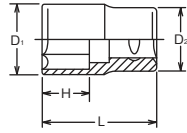

6400M 6405M (mm)	D ₁ (mm)	D ₂ (mm)	H (mm)	L (mm)	(g)	(pcs.)
14	22.1	34	11	50	160	10
16	24.6	34	12	50	167	10
17	26	34	12.5	50	175	5
18	27	34	13	50	178	5
19	28.5	34	13.5	50	179	5
20	29.5	34	14	50	185	5
21	31	34	14.5	50	185	5
22	32	34	15	50	187	5
23	33.5	34	16	50	187	5
24	34.5	34	17	50	200	5
25	36	34	17.5	50	217	5
26	37	34	18	50	222	5
27	38.5	37	19	53	254	5
28	39.5	38	19.5	53	298	5
29	41	38	20	55	292	5
30	42	38	21	55	301	5
31	43.5	38	22	57	294	5
32	44.5	40	23	57	351	5
33	46	40	23.5	57	384	5
34	47	40	24	57	397	5
35	48.5	42	24.5	59	422	5
36	49.5	42	25	59	438	5
37	51	42	25.5	59	484	5
38	52	45	26	59	523	5
39	53.5	45	26.5	59	538	5
40	54.5	45	27	62	550	5
41	56	47	28	62	633	5
42	57	47	28.5	62	652	2
43	58.5	47	29	62	659	2
44	59.5	47	29.5	62	657	2
45	61	47	30	68	734	2
46	62	47	31	68	791	2
47	63.5	48	31.5	68	816	2
48	64.5	45	32	68	800	2
50	67	48	34	68	880	2
52	69.5	53	33	72	925	2
54	72	55	33	72	1040	2
55	73.5	53	36	72	1006	2
56	74.5	53	36	72	1092	2
57	76	53	36	72	1169	2
58	77	53	36	72	1149	2
60	79.5	58	39	76	1402	2
63	83.5	58	39	76	1494	2
65	86	63	42	80	1608	2
70	92	68	45	84	1785	2
75	98.5	73	48	86	2186	1
78	102.1	73	55	86	2425	1
80	104.5	78	52	90	2475	1
85	111	78	52	90	2620	1

6405M / 6405A

12-point Sockets
12-kant Steckschlüssel
Douilles 12-pans

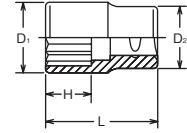

6400A 6405A (inch)	D ₁ (mm)	D ₂ (mm)	H (mm)	L (mm)	(g)	(pcs.)
5/8	24.6	34	12	50	168	10
11/16	27	34	13	50	178	5
3/4	28.5	34	13.5	50	179	5
25/32	29.5	34	14	50	185	5
13/16	31	34	14.5	50	185	5
7/8	32	34	15	50	187	5
15/16	34.5	34	17	50	200	5
31/32	36	34	17.5	50	217	5
1	37	34	18	50	222	5
1. 1/16	38.5	37	19	53	254	5
1. 1/8	41	38	20	53	292	5
1. 3/16	42	38	21	55	301	5
1. 1/4	44.5	40	23	57	351	5
1. 5/16	46	40	23.5	57	384	5
1. 3/8	48.5	42	24.5	57	422	5
1. 7/16	51	42	25.5	59	484	5
1. 1/2	52	45	26	59	523	5
1. 9/16	54.5	45	27	59	550	5
1. 5/8	56	47	28	62	633	5
1.11/16	58.5	47	29	62	659	2
1. 3/4	59.5	47	29.5	62	657	2
1.13/16	62	47	31	68	791	2
1. 7/8	64.5	45	32	68	892	2
1.15/16	66	48	32.5	68	870	2
2	68.5	52	34.5	68	949	2
2. 1/16	71	54	33	72	983	2
2. 1/8	72	55	33	72	1040	2
2. 3/16	74.5	53	36	72	1092	2
2. 1/4	76	53	36	72	1169	2
2. 5/16	78.5	53	36	72	1344	2
2. 3/8	79.5	58	39	76	1402	2
2. 7/16	82	58	39	76	1420	2
2. 1/2	84.5	58	39	76	1497	2
2. 9/16	86	63	42	80	1608	2
2. 5/8	88.5	63	42	80	1709	2
2.11/16	89.5	63	42	80	1634	2
2. 3/4	92	68	45	84	1785	2
2.13/16	94.5	68	45	84	2018	2
2. 7/8	96	68	45	84	2062	2
2.15/16	98.5	73	48	86	2186	1
3	101	73	48	86	2309	1
3. 1/8	104.5	78	52	90	2475	1

6425

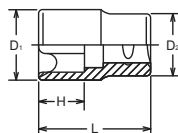

TORX® Sockets
TORX® Steckschlüssel
Douilles TORX®



6425 (E)	D ₁ (mm)	D ₂ (mm)	H (mm)	L (mm)	(g)	(pcs.)
E18	22.1	34	11.9	50	156	5
E20	24.6	34	13.3	50	166	5
E22	27.1	34	14.4	50	178	5
E24	28.6	34	16	50	185	5
E26	31.1	34	17.7	55	217	5
E28	32.1	34	24.1	60	237	5
E30	35	34	24.1	60	242	5
E32	36.1	34	24.1	60	247	5

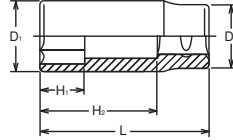

6300M / 6300A 6-point Deep Sockets 6-kant-Steckschlüssel, lang Douilles longues 6-pans





6300M 6305M (mm)	D ₁ (mm)	D ₂ (mm)	H ₁ (mm)	H ₂ (mm)	L (mm)	 (g)	 (pcs.)
17	26	34	18	64	90	278	5
18	27	34	19	64	90	281	5
19	28.5	34	20	64	90	292	5
20	29.5	34	21	64	90	334	5
21	31	34	22	64	90	343	5
22	32	34	23	64	90	347	5
23	33.5	34	24	64	90	361	5
24	34.5	34	25	64	90	352	5
25	36	34	26	64	90	369	5
26	37	34	27	64	90	384	5
27	38.5	37	28	64	90	425	5
28	39.5	38	29	63	90	470	5
29	41	38	30	63	90	503	5
30	42	38	31	63	90	503	5
31	43.5	38	32	62	90	517	5
32	44.5	40	34	62	90	544	5
33	46	40	34	62	90	557	5
34	47	40	35	61	90	570	5
35	48.5	42	36	61	90	622	5
36	49.5	42	37	61	90	631	2
38	52	45	39	60	90	710	2
40	54.5	45	41	60	90	742	2
41	56	47	42	59	90	802	2
42	57	47	43	59	90	829	2
44	59.5	47	45	59	90	838	2
46	62	47	47	58	90	906	2
48	64.5	50	49	57	90	998	2
50	67	48	51	57	90	1005	2
52	69.5	53	49	-	100	1270	2
53	71	54	49	-	100	1338	2
54	72	55	49	-	100	1351	2
55	73.5	53	52	-	100	1388	2
56	74.5	53	52	-	100	1389	2
57	76	53	52	-	100	1467	2
58	77	53	52	-	100	1480	2
60	79.5	58	55	-	100	1626	2
63	83.5	58	55	-	100	1740	2
65	86	63	65	-	100	1939	2

6305M / 6305A 12-point Deep Sockets 12-kant Steckschlüssel, lang Douilles longues, 12-pans



6300A 6305A (inch)	D ₁ (mm)	D ₂ (mm)	H ₁ (mm)	H ₂ (mm)	L (mm)	 (g)	 (pcs.)
3/4	28.5	34	20	64	90	292	5
25/32	29.5	34	21	64	90	334	5
13/16	31	34	22	64	90	343	5
7/8	32	34	23	64	90	347	5
15/16	34.5	34	25	64	90	352	5
1	37	34	27	64	90	384	5
1. 1/16	38.5	37	28	64	90	425	5
1. 1/8	41	38	30	63	90	503	5
1. 3/16	42	38	31	63	90	503	5
1. 1/4	44.5	40	34	62	90	544	5
1. 5/16	46	40	34	62	90	557	5
1. 3/8	48.5	42	36	61	90	622	5
1. 7/16	51	42	38	61	90	656	2
1. 1/2	52	45	39	60	90	710	2
1. 9/16	54.5	45	41	60	90	742	2
1. 5/8	56	47	42	59	90	802	2
1.11/16	58.5	47	44	59	90	831	2
1. 3/4	59.5	47	45	59	90	838	2
1.13/16	62	47	47	58	90	906	2
2	68.5	52	52	57	90	1061	2
2. 1/16	71	54	49	-	100	1338	2
2. 1/8	72	55	49	-	100	1351	2
2. 3/16	74.5	53	52	-	100	1389	2
2. 1/4	76	53	52	-	100	1467	2
2. 5/16	78.5	53	52	-	100	1787	2
2. 3/8	79.5	58	55	-	100	1626	2
2. 7/16	82	58	55	-	100	1715	2

6012M-75 (mm)	D (mm)	H ₁ (mm)	H ₂ (mm)	L (mm)	 (g)	 (pcs.)
12	35	15.5	40	75	253	10
14	35	15.5	40	75	265	10
15	35	15.5	40	75	271	10
16	35	15.5	40	75	285	10
17	35	15.5	40	75	292	10
18	35	15.5	40	75	302	10
19	35	15.5	40	75	312	10
20	35	15.5	40	75	323	10
21	38	15.5	40	75	330	10
22	38	22.5	40	75	340	10
24	38	22.5	40	75	362	10
27	38	22.5	40	75	402	10
30	38	28.5	40	75	445	10
32	38	28.5	40	75	485	10
36	42	28.5	40	75	663	10

6012M-75 Inhex Sockets Steckschlüssel für Innensechskant-Schrauben Douilles tournevis pour vis 6-pans creux

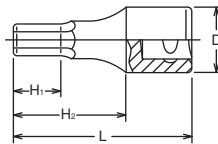

6101 Socket for Slotted Heads Steckschlüssel für Schlitzschrauben Douilles tournevis pour vis à fente

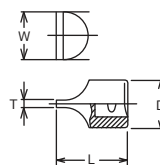

	T×W (mm)	D (mm)	L (mm)	 (g)	 (pcs.)
6101	6.4×33.5	35	50	205	5

Z-SERIES
HAND
TITANIUM
ACCESSORIES
SCREWDRIVERS
IMPACT
SLEEVE-DRIVE
PROTECTOR
INDUSTRIAL
AUTOMOTIVE
MOTORCYCLE
CONSTRUCTION
SPARE PART

6749
6749-1000 ⚠️
6749-HEAD
PIPE-400 / -800

Reversible Ratchet
Knarre, verstellbar
Cliquet, réversible



* Renewal Kits → 6749RK → P306

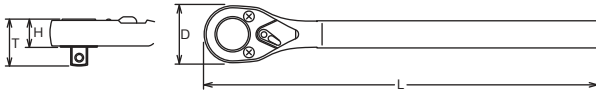

	D (mm)	T (mm)	H (mm)	L (mm)	(g)	(pce.)
6749	68	49.6	29.6	565	2840	1
6749-1000	68	49.6	29.6	965	3960	1
6749-HEAD	68	49.6	29.6	165	1730	1
PIPE-400	-	-	-	400	1110	1
PIPE-800	-	-	-	800	2230	1

⚠️ 6749-1000 have longer handle than standard, and can be loaded to excessive torque value. In the interest of your own safety always apply load evenly and progressively to avoid breakage and possible injury.



6752
6752-HEAD
PIPE-400

Reversible Ratchet
Knarre, verstellbar
Cliquet, réversible



* Renewal Kits → 6752RK → P307

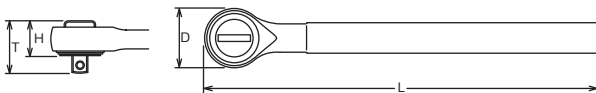

	D (mm)	T (mm)	H (mm)	L (mm)	(g)	(pce.)
6752	67	55.5	35.5	500	2360	1
6752-HEAD	67	55.5	35.5	100	1250	1
PIPE-400	-	-	-	400	1110	1



60

* Renewal Kits → 6755RK → P307

	D (mm)	L (mm)	(g)	(pce.)
6755	62	97	1162	1

6755 Ratchet Adaptor
Aufsteckknarre
Cliquet adaptable

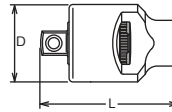

6760 Extension Bars
Verlängerungen
Rallonges



	D (mm)	L (mm)	(g)	(pce.)
6760-75	35	75	335	5
6760-100	35	100	434	2
6760-125	35	125	528	2
6760-150	35	150	624	2
6760-200	35	200	815	1
6760-300	35	300	1203	1
6760-400	35	400	1585	1

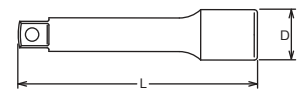

6768 Hinge Handle
Gelenkgriff
Poignée articulée



* Renewal Kits → 6768RK → P309

	D (mm)	L (mm)	(g)	(pce.)
6768	42	450	1715	1

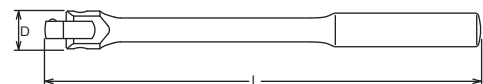

6768-600 / -1000 ⚠ Hinge Handle
Gelenkgriff
Poignée articulée
6768-HEAD
PIPE-400 / -800



* Renewal Kits → 6768RK → P309

6768	D (mm)	L (mm)	(g)	(pce.)
6768-600	42	600	2360	1
6768-1000	42	1000	3480	1
6768-HEAD	42	200	1250	1
PIPE-400	-	400	1110	1
PIPE-800	-	800	2230	1

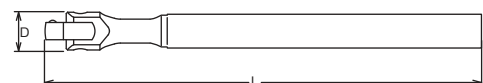

⚠ 6768-600/-1000 have longer handle than standard, and can be loaded to excessive torque value. In the interest of your own safety always apply load evenly and progressively to avoid breakage and possible injury.



Z-SERIES
HAND
TITANIUM
SCREWDRIVERS ACCESSORIES
IMPACT
SLEEVE-DRIVE
PROTECTOR
INDUSTRIAL
AUTOMOTIVE
MOTORCYCLE
CONSTRUCTION
SPARE PART

6785 T-Handle
T-Griff
Poignée coulissante

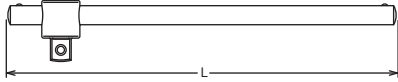
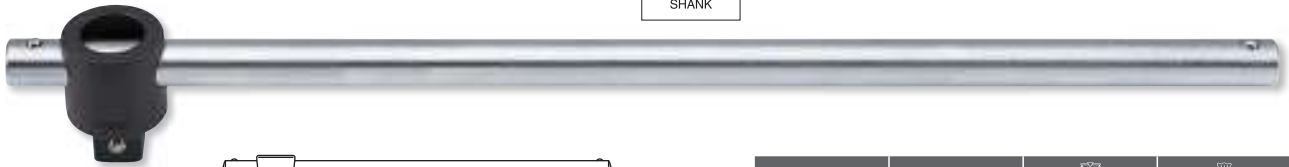

	L (mm)	⚖️ (g)	📦 (pcs.)
6785	500	1542	1

6788 L-Handle
L-Griff
Poignée en L

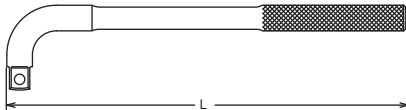
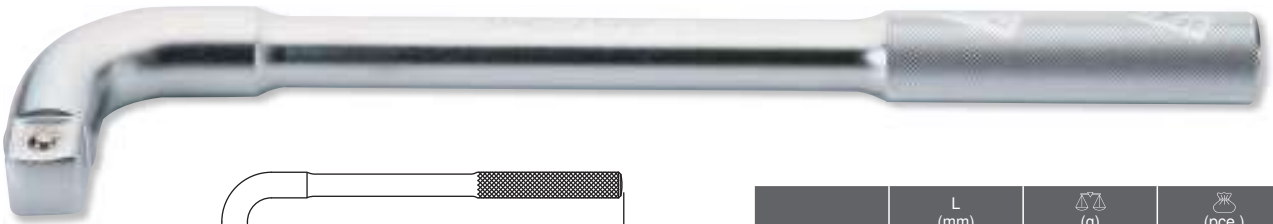

	L (mm)	⚖️ (g)	📦 (pcs.)
6788	330	1175	1

6770 Universal Joint
Gelenk-Einsatz
Cardan universel

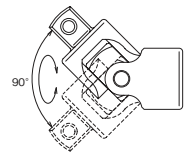
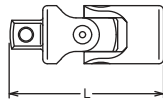

	L (mm)	⚖️ (g)	📦 (pcs.)
6770	105	478	2

6644A Adaptor
Verbindungsstück
Réducteur

Warranty 668Nm
Garantie 668Nm
Garantie 668Nm

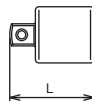

	▣ (sq.)	▣ (sq.)	L (mm)	⚖️ (g)	📦 (pcs.)
6644A	3/4"	1/2"	47	136	5
6688A	3/4"	1"	60	285	5

Adapting down from bigger square drive to smaller square drive may lead to excessive torque load and possibly cause breakage. Always stay within safe torque of the smaller square drive.

Die mit gekennzeichneten Artikel können bei Überbelastung zu Bruch gehen. Aus Gründen Ihrer eigenen Sicherheit sollten die betreffenden Werkzeuge nie ruckartig, sondern nach und nach belastet werden, um Bruch und damit verbundene mögliche Verletzungen zu vermeiden.

Il est possible d'appliquer aux articles marqués des couples de serrage susceptibles d'occasionner leur rupture. Pour votre propre sécurité, veuillez toujours appliquer la charge d'une manière uniforme et progressive. Ceci pour éviter ruptures et accidents.

6688A Adaptor
Verbindungsstück
Augmentateur

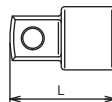

3/4"

Hand Sockets
Hand Steckschlüssel
Douilles à main

6201M-00
6201A-00
6201M-05
6201A-05

Socket Sets
Steckschlüssel Sätze
Jeux de clés à douilles



6201A-00 18 Pieces Set/△=17,600g
6201A-05 18 Pieces Set/△=17,600g

METAL CASE:W580×H200×T85mm

Sockets	Accessories
(6201A-00) 6400A 6-pt. Sockets 7/8, 15/16, 1.1/16, 1.1/8, 1.1/4, 1.5/16, 1.7/16, 1.1/2, 1.5/8, 1.11/16, 1.13/16, 1.7/8, 2	6749 6760-200 6760-400 6768 6785
(6201A-05) 6405A 12-pt. Sockets 7/8, 15/16, 1.1/16, 1.1/8, 1.1/4, 1.5/16, 1.7/16, 1.1/2, 1.5/8, 1.11/16, 1.13/16, 1.7/8, 2	

6201M-00 16 Pieces Set/△=17,300g
6201M-05 16 Pieces Set/△=17,300g

METAL CASE:W580×H200×T85mm

Sockets	Accessories
(6201M-00) 6400M 6-pt. Sockets 22, 24, 27, 30, 32, 36, 41, 46, 50, 55, 60	6749 6760-200 6760-400 6768 6785
(6201M-05) 6405M 12-pt. Sockets 22, 24, 27, 30, 32, 36, 41, 46, 50, 55, 60	

6212M-00
6212M-05

Socket Sets
Steckschlüssel Sätze
Jeux de clés à douilles



6212M-00 12 Pieces Set/△=8,200g
6212M-05 12 Pieces Set/△=8,200g

METAL CASE:W580×H124×T70mm

Sockets	Accessories
(6212M-00) 6400M 6-pt. Sockets 22, 24, 27, 30, 32, 36, 41, 46, 50	6749 6760-200 6785
(6212M-05) 6405M 12-pt. Sockets 22, 24, 27, 30, 32, 36, 41, 46, 50	

Hand Sockets
Hand Steckschlüssel 1”
Douilles à main

Z-SERIES
HAND
TITANIUM
SCREWDRIVERS ACCESSORIES
IMPACT
SLEEVE-DRIVE
PROTECTOR
INDUSTRIAL
AUTOMOTIVE
MOTORCYCLE
CONSTRUCTION
SPARE PART

8400M / 8400A

6-point Sockets
6-kant Steckschlüssel
Douilles 6-pans

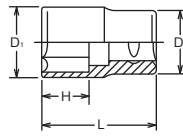

8405M / 8405A

12-point Sockets
12-kant Steckschlüssel
Douilles 12-pans

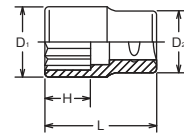

8400M 8405M (mm)	D ₁ (mm)	D ₂ (mm)	H (mm)	L (mm)	(g)	(pce.)
24	36.5	44	17	60	348	1
27	40.5	44	19	60	362	1
28	41.5	44	19.5	60	368	1
29	43	44	20	60	378	1
30	44	45	21	65	410	1
32	46.5	45	23	65	455	1
33	48	46	23.5	65	485	1
34	49	46	24	65	500	1
35	50.5	48	24.5	65	536	1
36	51.5	48	25	65	600	1
38	54	50	26	65	624	1
40	56.5	53	27	65	686	1
41	58	53	28	68	747	1
42	59	53	28.5	68	789	1
46	64	53	31	72	928	1
50	69	53	34	72	943	1
54	74	55	37	72	1016	1
55	75.5	53	42	77	1167	1
56	76.5	53	42	77	1160	1
58	79	53	41	77	1200	1
60	81.5	58	46	82	1440	1
63	85.5	58	45	82	1470	1
64	86.5	58	46	82	1540	1
65	88	63	49	86	1683	1
67	90.5	63	49	86	1840	1
68	91.5	63	49	86	1800	1
70	94	68	50	88	1963	1
71	95.5	68	50	88	2200	1
75	100.5	73	53	90	2204	1
78	104	75	52.5	90	2500	1
80	106.5	75	58	95	2550	1
83	110.5	78	57	95	2730	1
85	113	80	57	95	2680	1
90	119	80	59	100	3420	1
95	125.5	85	58	100	4900	1
100	131.5	85	57	100	4840	1

8400A 8405A (inch)	D ₁ (mm)	D ₂ (mm)	H (mm)	L (mm)	(g)	(pce.)
15/16	36.5	44	17	60	355	1
1. 3/16	44	45	21	65	410	1
1. 1/4	46.5	45	23	65	455	1
1. 5/16	48	46	23.5	65	485	1
1. 3/8	50.5	48	24.5	65	536	1
1. 7/16	53	50	25.5	65	607	1
1. 1/2	54	50	26	65	624	1
1. 9/16	56.5	53	27	65	686	1
1. 5/8	58	53	28	68	747	1
1.11/16	60.5	53	29	68	830	1
1. 3/4	61.5	53	29.5	68	807	1
1.13/16	64	53	31	72	928	1
1. 7/8	66.5	53	32	72	936	1
1.15/16	68	53	32.5	72	941	1
2	70.5	53	37	72	976	1
2. 1/16	73	54	37	72	1027	1
2. 1/8	74	55	37	72	1016	1
2. 3/16	76.5	53	41	77	1192	1
2. 1/4	78	53	41	77	1177	1
2. 5/16	80.5	53	41	77	1292	1
2. 3/8	81.5	58	46	82	1440	1
2. 7/16	84	58	45	82	1495	1
2. 1/2	86.5	58	45	82	1497	1
2. 9/16	88	63	49	86	1683	1
2. 5/8	90.5	63	49	86	1840	1
2.11/16	91.5	63	49	86	1800	1
2. 3/4	94	68	50	88	1963	1
2.13/16	96.5	68	50	88	2035	1
2. 7/8	98	70	50	88	2100	1
2.15/16	100.5	73	53	90	2204	1
3	103	75	53	90	2406	1
3. 1/8	106.5	75	58	95	2550	1
3. 1/4	110.5	78	57	95	2730	1
3. 3/8	114	80	57	95	3050	1
3. 1/2	119	80	59	100	3420	1
3. 3/4	125.5	85	58	100	4900	1

8012M-80 (mm)	D (mm)	H ₁ (mm)	H ₂ (mm)	L (mm)	(g)	(pcs.)
17	44.2	15.5	45	80	400	5
19	44.2	15.5	45	80	410	5
22	47.9	22.5	45	80	436	5
24	47.9	22.5	45	80	471	5
27	47.9	22.5	45	80	526	5
30	47.9	22.5	45	80	658	5
32	47.9	22.5	45	80	715	5
36	54.2	22.5	45	80	945	5

8012M-80

 Inhex Sockets
Steckschlüssel für Innensechskant-Schrauben
Douilles tournevis pour vis 6-pans creux

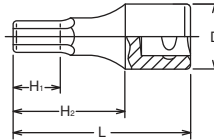

	D (mm)	L (mm)	(g)	(pce.)
8760-200	44	200	1300	1
8760-400	44	400	2570	1

8760

Extension Bars
Verlängerungen
Rallonges

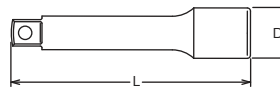

	L (mm)	(g)	(pce.)
8770	143	1170	1

8770

Universal Joint
Gelenk-Einsatz
Cardan universel

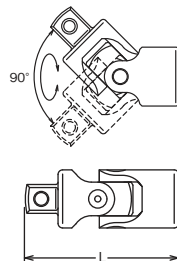

	(mm)	(mm)	L (mm)	(g)	(pcs.)
8866A	1"	3/4"	60	338	5

 Adapting down from bigger square drive to smaller square drive may lead to excessive torque and possibly cause breakage.

Reduzierstücke sind mit Vernunft einzusetzen.
Es besteht Bruchgefahr. Überschreiten Sie niemals die Sicherheitsgrenzen.

Les réducteurs doivent être utilisés avec modération. Ne dépassez jamais les limites de sécurité.

8866A

Adaptor
Verbindungsstück
Réducteur

Warranty 1850Nm 
Garantie 1850Nm
Garantie 1850Nm

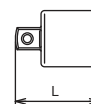

Z-SERIES
HAND
TITANIUM
SCREWDRIVERS ACCESSORIES
IMPACT
SLEEVE-DRIVE
PROTECTOR
INDUSTRIAL
AUTOMOTIVE
MOTORCYCLE
CONSTRUCTION
SPARE PART

8749
8749-1000 ⚠
8749-HEAD
PIPE-580 / -800

Reversible Ratchet
Knarre, verstellbar
Cliquet, réversible



* Renewal Kits → 8749RK → P306

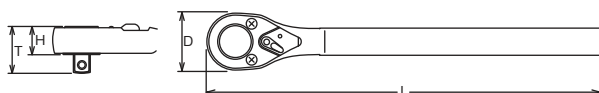

	D (mm)	T (mm)	H (mm)	L (mm)	(g)	(pce.)
8749	70	62.2	36.2	800	4100	1
8749-1000	70	62.2	36.2	1020	4720	1
8749-HEAD	70	62.2	36.2	220	2490	1
PIPE-580	—	—	—	580	1610	1
PIPE-800	—	—	—	800	2230	1

⚠ 8749-1000 have longer handle than standard, and can be loaded to excessive torque value. In the interest of your own safety always apply load evenly and progressively to avoid breakage and possible injury.

8768
8768-1000 ⚠
8768-HEAD
PIPE-400 / -800

Hinge Handle
Gelenkgriff
Poignée articulée

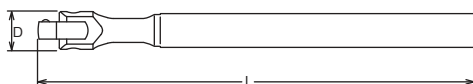

* Renewal Kits → 8768RK → P309

	D (mm)	L (mm)	(g)	(pce.)
8768	55	600	2590	1
8768-1000	55	1000	3710	1
8768-HEAD	55	200	1480	1
PIPE-400	—	400	1110	1
PIPE-800	—	800	2230	1

⚠ 8768-1000 have longer handle than standard, and can be loaded to excessive torque value. In the interest of your own safety always apply load evenly and progressively to avoid breakage and possible injury.

8785
8785-700 ⚠

T-Handle
T-Griff
Poignée coulissante

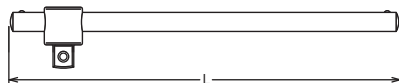
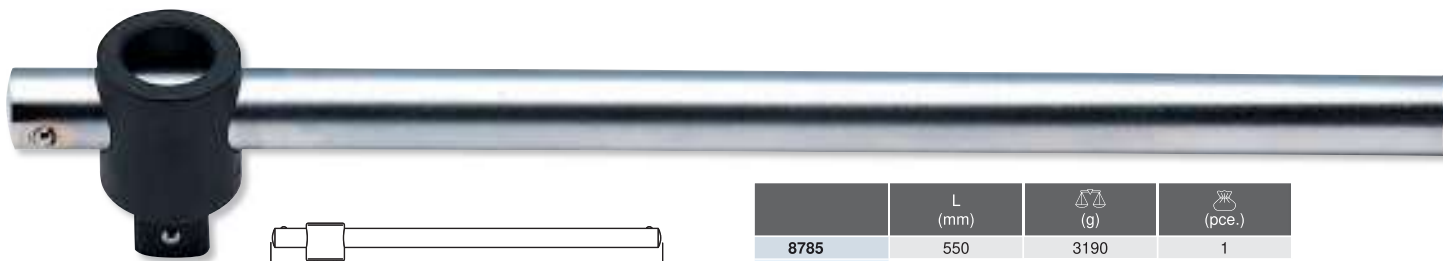

	L (mm)	(g)	(pce.)
8785	550	3190	1
8785-700	700	3906	1

⚠ 8785-700 have longer handle than standard, and can be loaded to excessive torque value. In the interest of your own safety always apply load evenly and progressively to avoid breakage and possible injury.

8788
L-Handle
L-Griff
Poignée en L

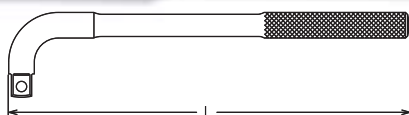
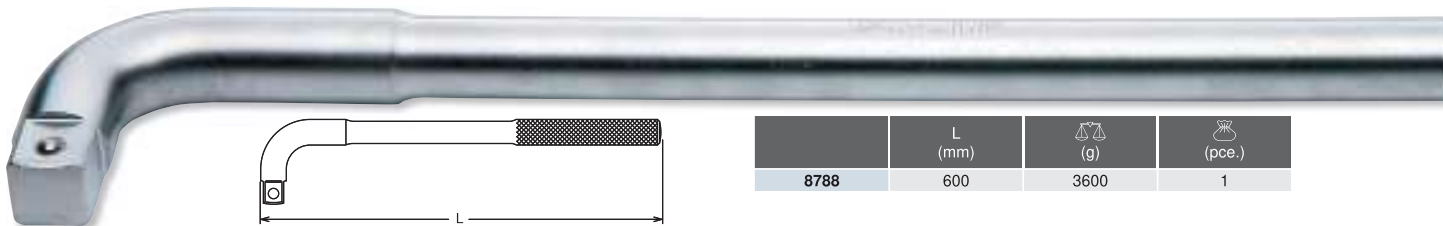

	L (mm)	(g)	(pce.)
8788	600	3600	1

1”

Hand Sockets
Hand Steckschlüssel
Douilles à main

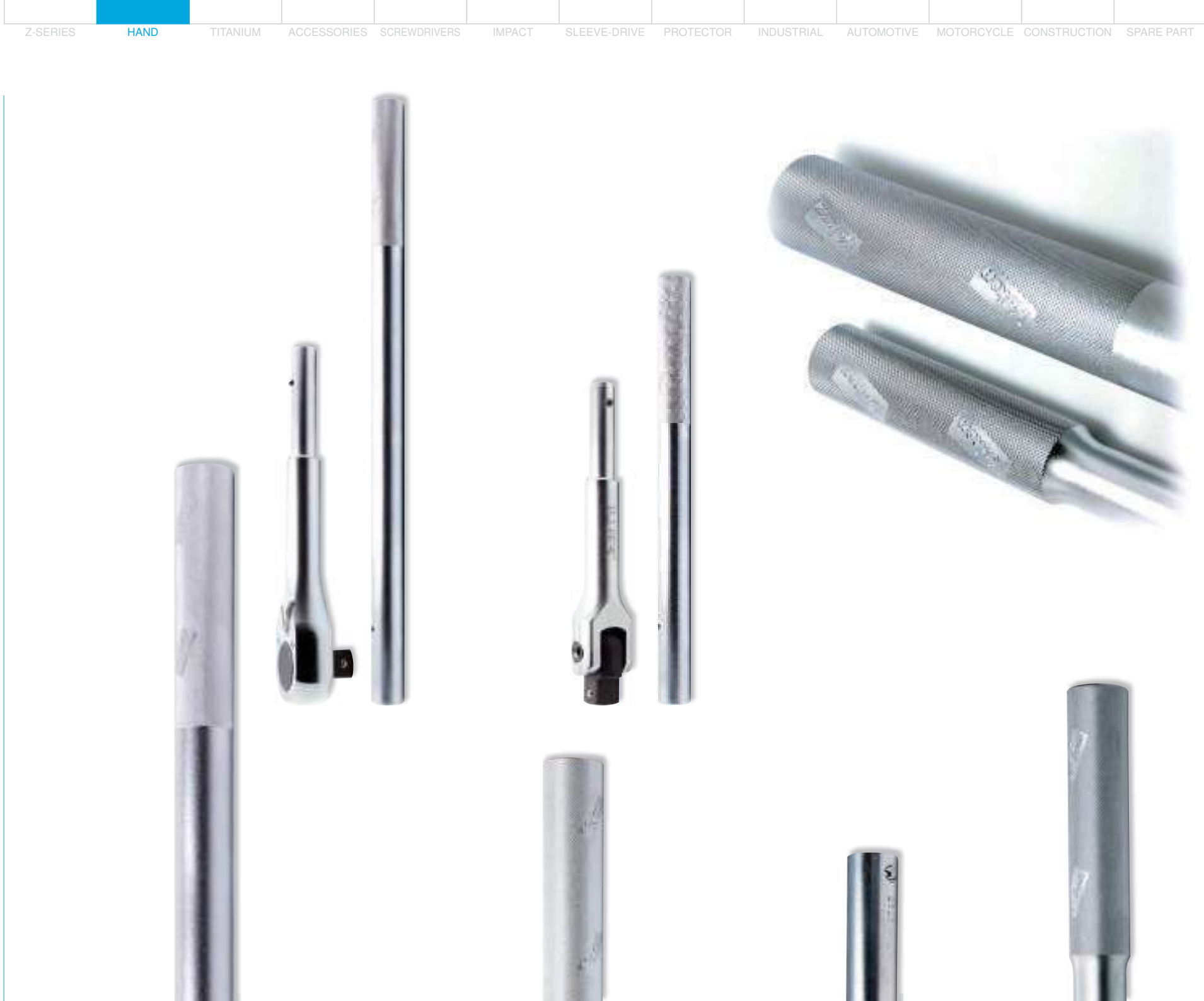

Hand Sockets
Hand Steckschlüssel
Douilles à main

1"

8225M-00 Socket Sets
Steckschlüssel Sätze
Jeux de clés à douilles

8225M-05



8225M-00 15 Pieces Set/重量=27.000g
8225M-05 15 Pieces Set/重量=27.000g

METAL CASE:W600×H217×T97mm

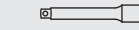
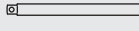
Sockets	Accessories
(8225M-00) 8400M 6-pt. Sockets 32, 33, 36, 41, 46, 50, 55, 60, 65, 70, 75, 80	 8749
(8225M-05) 8405M 12-pt. Sockets 32, 33, 36, 41, 46, 50, 55, 60, 65, 70, 75, 80	 8760-200
	 8760-400



Z-SERIES
HAND
TITANIUM
SCREWDRIVERS ACCESSORIES
IMPACT
SLEEVE-DRIVE
PROTECTOR
INDUSTRIAL
AUTOMOTIVE
MOTORCYCLE
CONSTRUCTION
SPARE PART

TITAN-SOCKETS & ACCESSORIES
TITAN STECKSCHLÜSSEL UND ZUBEHÖRTEILE
DOUILLES ET ACCESSOIRES TITAN

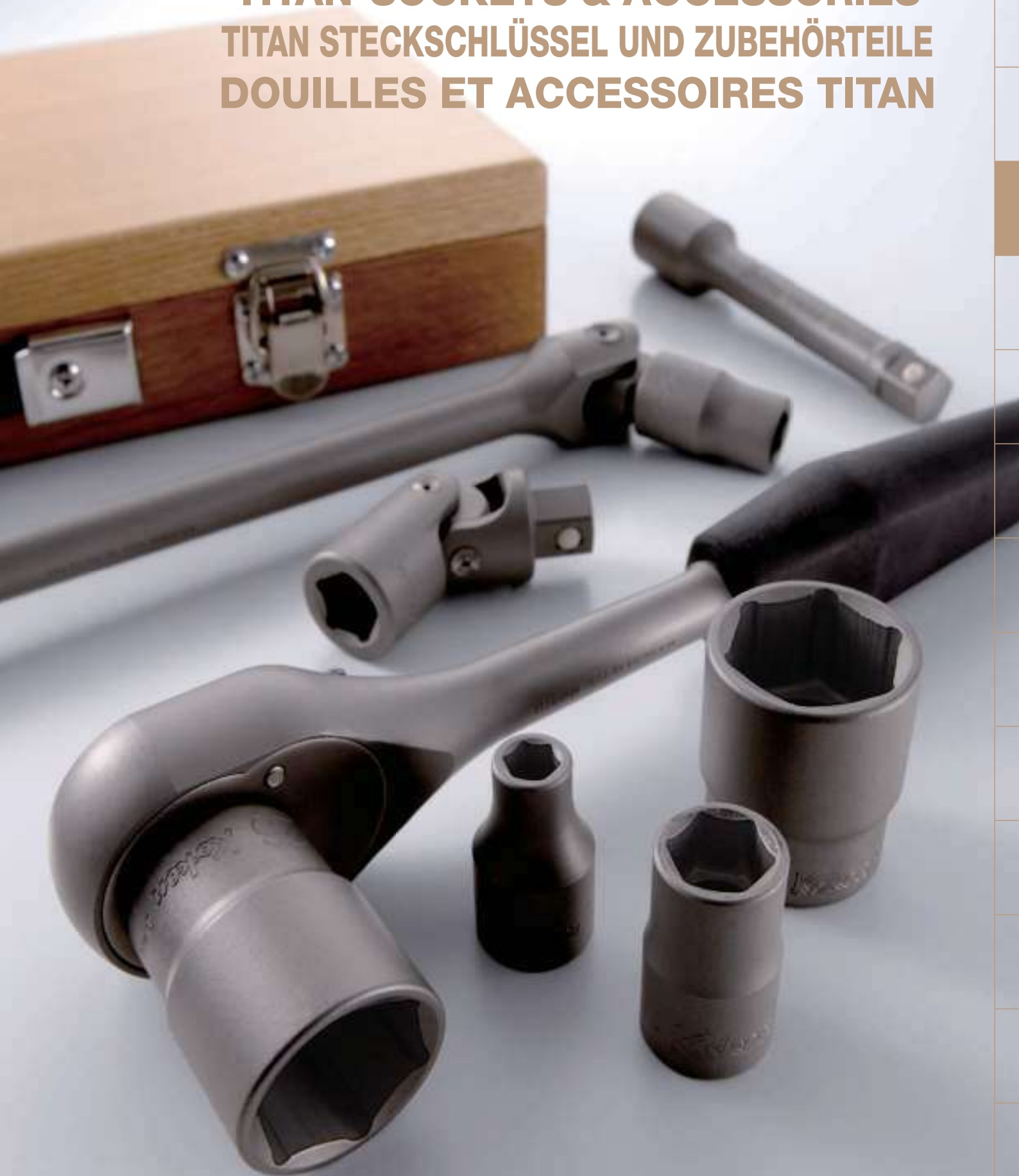





Z-SERIES
HAND
TITANIUM
SCREWDRIVERS ACCESSORIES
IMPACT
SLEEVE-DRIVE
PROTECTOR
INDUSTRIAL
AUTOMOTIVE
MOTORCYCLE
CONSTRUCTION
SPARE PART

TI4261M

Socket Set Titanium
Steckschlüssel Satz Titanium
Jeu de clés à douille Titanium

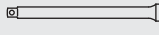
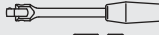

Pentagon Drive

TI4261M		18 Pieces Set/△=4,280g	
WOODEN CASE:W445×H190×T60mm			
Sockets		Accessories	
	TI4400M 6-pt. Sockets 8, 10, 11, 12, 13, 14, 17, 19, 21, 22, 24, 26, 27		TI4749J
			TI4760-125
			TI4760-250
			TI4768J-380
			TI4770

Characteristic of TITAN

- Light weight** : Makes it effective for operating tools. The specific gravity is only about 58% of chrome molybdenum steel which is used for our normal products.
- Non-Corrosion** : Corrosion Resistance is greatly improved against salt water and any kind of chemical products.
- Non-Magnetic** : Non-Magnetic material will prevent the tools from magnetizing.

Eigenschaften der TITAN Legierung

- Geringes Gewicht** : Das spezifische Gewicht liegt bei 58% herkömmlicher Chrom-Molybdän Stähle.
- Korrosionsfest** : Meerwasser oder Säuren hinterlassen keine Spuren.
- Nicht magnetisch** : Titan Werkzeuge lassen sich nicht magnetisieren.

Caractéristiques de l'alliage TITAN

- Légèreté** : Son poids spécifique n'est que 58% de celui de l'acier au chrome-molybdène utilisé pour tous nos produits standards.
- Anti-corrosion** : Aussi bien pour l'eau que pour tous les produits chimiques.
- Anti-magnétique** : Le Titan empêche toute magnétisation de l'outil.



Pentagonal drive is designed to avoid using with normal square drive items, so that it will provide extra safety and much more strength.

Der 5-kant Antrieb (Pentagon-Drive) gewährt einen kraftvollen Anzug und unterbindet aus Sicherheitsgründen die Verwendung von Zubehörteilen anderer Legierungen.

L'entraînement pentagonal est conçu pour obtenir un serrage puissant et pour empêcher l'utilisation d'accessoires traditionnels et ce pour des raisons de sécurité.



ACCESSORIES
ZUBEHÖRTEILE
ACCESSOIRES



Z-SERIES
 HAND
 TITANIUM
 ACCESSORIES
 SCREWDRIVERS
 IMPACT
 SLEEVE-DRIVE
 PROTECTOR
 INDUSTRIAL
 AUTOMOTIVE
 MOTORCYCLE
 CONSTRUCTION
 SPARE PART

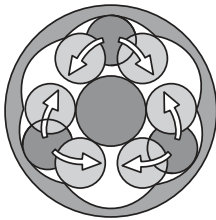
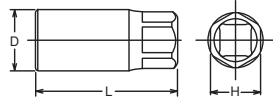

4100M / 4100A Stud Pullers Stehbolzendreher Extracteurs de goujons





Stud Pullers
 Hexagon body design can lessen the excessive load on cages and rollers inside the pullers.

Stehbolzendreher
 Der neue Körper mit sechs Walzenmulden verteilt den Druck auf Käfig und Walzen weitaus vorteilhafter.

Extracteurs de goujons
 Le nouveau corps de forme hexagonale répartit l'effort de façon plus uniforme sur la cage et les rouleaux.

4100M (mm)		D (mm)	L (mm)	H (mm)	(g)	(pcs.)	
5	1/2"	24	65	21	145	10	
6		24	65	21	150	10	
7		24	65	21	150	10	
8		24	65	21	147	10	
9		28	75	21	217	10	
10		28	75	21	213	10	
10.5		28	75	21	202	10	
11		28	75	21	218	10	
12		28	75	21	220	10	
14		34	75	27	340	5	
16		- 	34	75	27	315	5

4100A (inch)		D (mm)	L (mm)	H (mm)	(g)	(pcs.)
1/4	1/2"	24	65	21	150	10
5/16		24	65	21	147	10
3/8		28	75	21	213	10
7/16		28	75	21	218	10
1/2		28	75	21	191	10
9/16		34	75	27	340	5
5/8	- 	34	75	27	315	5



* Renewal Kits → **4100MRK/4100ARK** → **P309**
 4100M-16 and 4100A-5/8 do not have 1/2" square drive.
 Drive the outer hexagon part with 27mm sockets or ring wrenches.
 Die Artikel 4100M 16mm und 4100A 5/8" haben keinen 1/2" Antriebsvierkant.
 Bitte benutzen Sie den 27mm Aussensechskant.
 Les articles 4100M-16 et 4100A-5/8" n'ont pas de carré entraînant 1/2" , veuillez utiliser l'hexagonal 6 pans 27 mm



Tolerance

4100M (mm)		4100A (inch)	
5	4.7- 5	1/4	6 - 6.4
6	5.6- 6	5/16	7.6- 8
7	6.6- 7	3/8	9 - 9.6
8	7.6- 8	7/16	10.5-11.1
9	8.4- 9	1/2	12.1-12.7
10	9.4-10	9/16	13.5-14.3
10.5	9.9-10.5	5/8	15.2-16
11	10.4-11		
12	11.4-12		
14	13.2-14		
16	15.2-16		

4211M / 4211A Stud Pullers Sets Stehbolzendreher im Satz Jeux d'extracteurs de goujons





4211M 4 Pieces Set/ =1,040g
 METAL CASE:W215xH80xT47mm
 PULLER
 **4100M** Stud Pullers
 6, 8, 10, 12

4211A 4 Pieces Set/ =1,040g
 METAL CASE:W215xH80xT47mm
 PULLER
 **4100A** Stud Pullers
 1/4, 5/16, 3/8, 1/2

4214M Stud Pullers Set Stehbolzendreher im Satz Jeux d'extracteurs de goujons



4214M 5 Pieces Set/ =1,450g
 METAL CASE:W215xH80xT47mm
 PULLER
 **4100M** Stud Pullers
 6, 8, 10, 12, 14

6100M (mm)		D (mm)	L (mm)	H (mm)	(g)	(pcs.)
18	3/4"	48	100	36	840	1
20		48	100	36	816	1
22		48	100	36	745	1
24		48	100	36	739	1
27		63	125	46	1707	1
28		63	125	46	1701	1
29		63	125	46	1696	1
30		63	125	46	1691	1

* Renewal Kits → 6100MRK → P309

6100M-22 to -30 do not have 3/4" square drive.
Drive the outer hexagon part with sockets or ring wrenches
(size 22-24mm = 36H, 27-30mm = 46H.)
Die Stehbolzendreher ab Abmessung 22mm haben keinen 3/4" Antriebsvierkant.
Bitte benutzen sie den Aussensechskant.

Tolerance

6100M (mm)	Tolerance (mm)
18	16.9-18
20	18.8-20
22	20.8-22
24	22.7-24
27	25.7-27
28	26.7-28
29	27.6-29
30	28.6-30

6100M Stud Pullers
Stehbolzendreher
Extracteurs de goujons

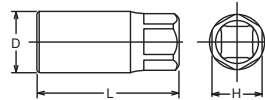

14100M (mm)		D ₁ (mm)	D ₂ (mm)	L (mm)	(g)	(pcs.)	
6	1/2"	24	25	48	126	10	*1
7		24	25	48	126	10	*1
8		24	25	48	122	10	*1
9		28	30	48	181	10	*2
10		28	30	48	181	10	*2
12		28	30	48	175	10	*2

14100A (inch)		D ₁ (mm)	D ₂ (mm)	L (mm)	(g)	(pcs.)	
1/4	1/2"	24	25	48	126	10	*1
5/16		24	25	48	122	10	*1
3/8		28	30	48	181	10	*2
7/16		28	30	48	181	10	*2
1/2		28	30	48	180	10	*2

*1 C-Ring=C41, Pin/O-Ring=A41/B41 → P256-257
*2 C-Ring=C42, Pin/O-Ring=A42/B42

Tolerance

14100M (mm)	Tolerance (mm)	14100A (inch)	Tolerance (inch)
6	5.6- 6	1/4	6 - 6.4
7	6.6- 7	5/16	7.6- 8
8	7.6- 8	3/8	9 - 9.6
9	8.4- 9	7/16	10.5-11.1
10	9.4-10	1/2	12.1-12.7
12	11.4-12		

14100M / 14100A IMPACT Stud Pullers
IMPACT Stehbolzendreher
Extracteurs de goujons IMPACT

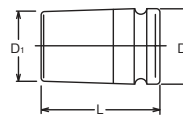

Stud Pullers & Setters
 Stehbolzendreher
 Extracteurs de goujons

Z-SERIES
 HAND
 TITANIUM
 ACCESSORIES
 SCREWDRIVERS
 IMPACT
 SLEEVE-DRIVE
 PROTECTOR
 INDUSTRIAL
 AUTOMOTIVE
 MOTORCYCLE
 CONSTRUCTION
 SPARE PART

141S / 141 ○ Stud Puller Ratchets
 Stehbolzensausdreher-Knarren
 Dégoujoneuses à cliquet

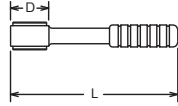

141S (mm)	D (mm)	L (mm)	(g)	(pce.)
6	28	120	150	1
8	28	120	150	1
10	32	120	153	1
12	32	120	152	1

141S (inch)	D (mm)	L (mm)	(g)	(pce.)
5/16	28	120	150	1
3/8	32	120	153	1
1/2	32	120	152	1

141 (mm)	D (mm)	L (mm)	(g)	(pce.)
6	28	205	215	1
8	28	205	215	1
10	32	205	234	1
12	32	205	233	1

141 (inch)	D (mm)	L (mm)	(g)	(pce.)
5/16	28	205	215	1
3/8	32	205	234	1
1/2	32	205	233	1

141P ○ Stud Puller Ratchets
 Stehbolzensausdreher-Knarren
 Dégoujoneuses à cliquet

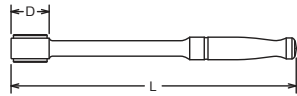

141P (mm)	D (mm)	L (mm)	(g)	(pce.)
6	28	205	210	1
8	28	205	210	1
10	32	205	229	1
12	32	205	227	1

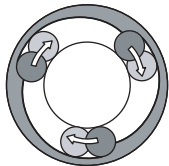

The three roller system can protect the studs from damage.
 Das Drei-Rollen-System schont die Stehbolzen.
 Le système à trois roulettes n'endommage pas les goujons.



1201 ○ Stud Puller Ratchets
 Stehbolzensausdreher-Knarren
 Dégoujoneuses à cliquet



1201 4 Pieces Set/△=973g
 METAL CASE:W240×H100×T32mm
 PULLER
 ○ 141S Stud Puller Ratchet
 6, 8, 10, 12

4104 ○ Stud Puller
 Stehbolzendreher
 Extracteur de goujons

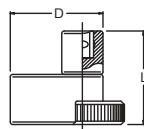

4104	□	Tolerance		D (mm)	L (mm)	(g)	(pcs.)
		min	max				
	1/2"	φ 6	φ 19	54	56	489	2

4103M (mm)		D ₁ (mm)	D ₂ (mm)	H (mm)	L (mm)	(g)	(pcs.)
6(1.0)	1/2"	10.3	22	9	37	54	10
7(1.0)		11.5	22	10	37	58	10
8(1.25)		13.2	22	11	37	60	10
10(1.25)		15.3	23	13	44	86	10
10(1.5)		15.3	23	13	44	86	10
12(1.25)		17.8	23	14	44	86	10
12(1.75)		17.8	23	14	44	86	10



4103M Stud Bolt Setters
Stehbolzensetzer

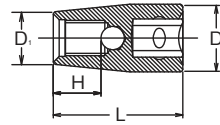

Depend on the stud bolt and using torque, 4103M/13103M/14103M may cause a scratch against the stud bolts or got stuck itself during a work.

4203M 4 Pieces Set/△=530g
METAL CASE:W130×H65×T26mm
Stud Bolt Setter

4103M Stud Bolt Setters
6(1.0), 8(1.25), 10(1.5), 12(1.75)

4203MF 4 Pieces Set/△=530g
METAL CASE:W130×H65×T26mm
Stud Bolt Setter

4103M Stud Bolt Setters
6(1.0), 8(1.25), 10(1.25), 12(1.25)

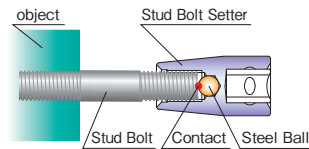

A special socket for installing a stud bolt.
Inside steel ball prevents the stud bolt stuck onto the socket. After installing a stud bolt, turn to anti-clockwise to removing the socket.

Spezialwerkzeug zum Setzen von Stehbolzen. Der Bolzen trifft im Werkzeug nur auf die gehärtete Stahlkugel, was die Kontaktfläche verringert. Nach dem Setzen des Stehbolzens kann das Werkzeug im Linkslauf vom Stehbolzen abgezogen werden.

Douilles spéciales pour monter les goujons.
Le goujon est en contact avec une bille d'acier pour l'empêcher d'adhérer à la douille.
Après avoir posé le goujon, tourner dans le sens antihorlogique pour le retirer

4203M Stud Bolt Setters Set
4203MF Stehbolzensetzer im Satz
Jeu de monte-goujons



13103M (mm)		D ₁ (mm)	D ₂ (mm)	H (mm)	L (mm)	(g)	(pcs.)	
5(0.8)	3/8"	9.5	19	8	32	39	10	*1
6(1.0)		10.8	19	9	32	41	10	*1
7(1.0)		12.5	19	10	32	44	10	*1
8(1.25)		13.5	19	11	35	49	10	*1
10(1.25)		15.8	19	13	35	49	10	*1
10(1.5)		15.8	19	13	35	49	10	*1

*1 C-Ring=C31, Pin/O-Ring=A31/B31 → P256-257

Depend on the stud bolt and using torque, 4103M/13103M/14103M may cause a scratch against the stud bolts or got stuck itself during a work.

13103M Impact Stud Bolt Setters
Impact Stehbolzensetzer

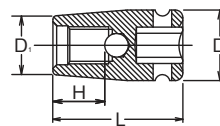

14103M (mm)		D ₁ (mm)	D ₂ (mm)	H (mm)	L (mm)	(g)	(pcs.)	
6(1.0)	1/2"	12	25	11	42	75	10	*1
7(1.0)		13.2	25	12	42	78	10	*1
8(1.25)		14.5	25	15	42	81	10	*1
10(1.25)		17	25	18	49	106	10	*1
10(1.5)		17	25	18	49	106	10	*1
12(1.25)		19.5	25	19	49	107	10	*1
12(1.75)		19.5	25	19	49	107	10	*1
14(1.5)		22	25	21	55	128	10	*1
14(2.0)	22	25	21	55	128	10	*1	

*1 C-Ring=C41, Pin/O-Ring=A41/B41 → P256-257

Depend on the stud bolt and using torque, 4103M/13103M/14103M may cause a scratch against the stud bolts or got stuck itself during a work.

14103M Impact Stud Bolt Setters
Impact Stehbolzensetzer

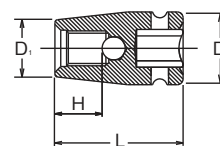

Tap Holder / Die Holder
 Halter für Gewindeschneider / Halter für Gewindeschneideisen
 Porte taraud / Porte-filière

Z-SERIES
 HAND
 TITANIUM
 SCREWDRIVERS
 ACCESSORIES
 IMPACT
 SLEEVE-DRIVE
 PROTECTOR
 INDUSTRIAL
 AUTOMOTIVE
 MOTORCYCLE
 CONSTRUCTION
 SPARE PART

3131E Tap Holder
 Halter für Gewindeschneider
 Porte taraud / porte-filière

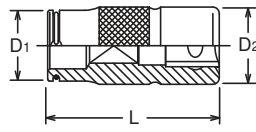

3131E	□	D ₁ (mm)	D ₂ (mm)	L (mm)	(g)	(pcs.)
□2.1 × ø2.8	3/8"	6.8	18	40	45	10
□2.7 × ø3.5		8	18	40	46	10
□3.4 × ø4.5		9.5	18	40	47	10
□4.9 × ø6		11.5	18	40	48	10
□5.5 × ø7		12.5	18	40	49	10
□7 × ø9		15	18	40	48	10
□9 × ø11		17	18	40	48	10
□9 × ø12		18	18	40	48	10

For DIN352, DIN351, DIN2181, DIN5157 tap

3264 Tap Holder set 10 pieces
 Halter für Gewindeschneider im Satz
 Jeu de portes taraud



3264		10 Pieces Set/ 1.050g	
METAL CASE: W240xH100xT32mm			
Sockets		Accessories	
3131E	□2.1×ø2.8, □2.7×ø3.5, □3.4×ø4.5, □4.9×ø6, □5.5×ø7, □7×ø9, □9×ø11, □9×ø12,		160K
			3760-125

3131A	□	S(mm)		L (mm)	(g)	(pcs.)
		Min.	Max.			
1	3/8"	2.0	5.0	42	80	5
		4.5	8.0	47	100	5
4131A	□	S(mm)		L (mm)	(g)	(pcs.)
		Min.	Max.			
3	1/2"	5.5	12	69	400	2

3131A Adjustable Tap Holder
 Halter für Gewindeschneider, einstellbar
4131A Porte taraud, ajustable

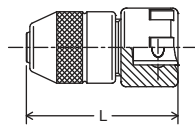

S(mm)

Min. Max.

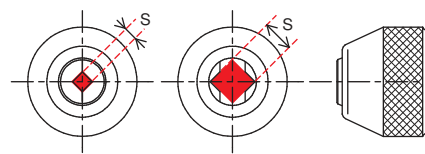

160K Reversible Ratchet
 Verstellbare Knarre
 Cliquet réversible

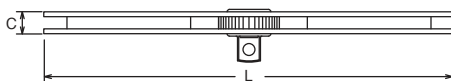

Tap is not included.
 Gewindeschneider, nicht enthalten.
 Taraud non inclus.

	□	C (mm)	L (mm)	(g)	(pce.)
160K	3/8"	10	220	130	1
160K-1/2	1/2"	10	220	135	1

3132 Die Holder
 Halter für Gewindeschneideisen
4132 Porte-filière

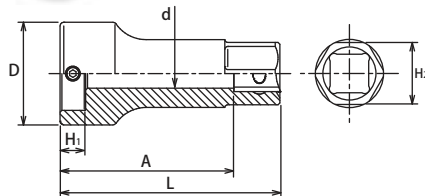

	□	D (mm)	H ₁ (mm)	H ₂ (mm)	d (mm)	A (mm)	L (mm)	(g)	(pcs.)
3132-20	3/8"	28	7	17	8	45	60	130	5
4132-25		34	9	22	14	40	60	170	2
4132-38	1/2"	48	13	24	18	60	80	315	2
4132-50		60	16	27	30	85	105	740	2



Die is not included.
 Gewindeschneideisen, nicht enthalten.
 Filière non inclus.

2127 (mm)	□	D ₁ (mm)	D ₂ (mm)	H (mm)	L (mm)	(g)	(pcs.)
4	1/4"	7	13	4	23	14	10
4.5		7.4	13	4	23	14	10
5		8	13	5	23	14	10
5.5		8.8	13	5	23	14	10
6		9.5	13	6	23	14	10
7		10.9	13	6	23	14	10
8		11.5	13	8	23	14	10
9		13	13	8	23	15	10
9.5		13.8	13	10	23	16	10
10		14.8	13	10	23	17	10



2127 ○ NUTTWISTER®

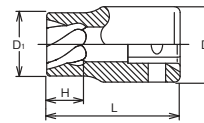

RS2127/6	6 Pieces Set/Rail 150mm	(g)
4, 4.5, 5, 5.5, 6, 7		105

RS2127/6 ○ ■■ Socket Set on Rail
Steckschlüsselsatz auf Schiene
Jeu de douilles sur rail



RS2127/10	10 Pieces Set/Rail 150mm	(g)
4, 4.5, 5, 5.5, 6, 7, 8, 9, 9.5, 10		180

RS2127/10 ○ ■■ Socket Set on Rail
Steckschlüsselsatz auf Schiene
Jeu de douilles sur rail



3127 (mm)	□	D ₁ (mm)	D ₂ (mm)	H (mm)	L (mm)	(g)	(pcs.)
8	3/8"	11.5	19	8	32	40	10
9		13	19	8	32	40	10
9.5		13.8	19	8	32	41	10
10		14.8	19	10	32	41	10
11		16	19	10	32	43	10
12		17	19	12	32	44	10
13		18.5	19	12	32	46	10
14		19.7	19	14	32	48	10
15		20.7	19	14	32	52	10
16		22.2	22	14	32	66	10
17	23.5	22	16	35	80	10	
19	26	22	16	35	92	10	

3127 ○ NUTTWISTER®

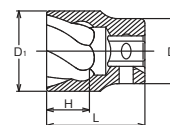

RS3127/8	8 Pieces Set/Rail 200mm	(g)
8, 9, 10, 11, 12, 13, 14, 16		420

RS3127/8 ○ ■■ Socket Set on Rail
Steckschlüsselsatz auf Schiene
Jeu de douilles sur rail



3128-80 (mm)	□	D ₁ (mm)	D ₂ (mm)	H (mm)	L (mm)	(g)	(pcs.)
8	3/8"	11.5	19	6	80	58	10
9		13	19	6	80	61	10
10		14.8	19	8	80	66	10
11		16	19	8	80	70	10
12		17	19	10	80	77	10
13		18.5	19	10	80	80	10
14		19.7	19	12	80	82	10

3128 (L80) ○ NUTTWISTER® (Long type)

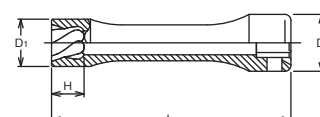

Z-SERIES
HAND
TITANIUM
ACCESSORIES
SCREWDRIVERS
IMPACT
SLEEVE-DRIVE
PROTECTOR
INDUSTRIAL
AUTOMOTIVE
MOTORCYCLE
CONSTRUCTION
SPARE PART

4127  NUTTWISTER®

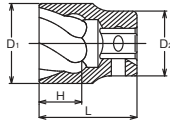

4127 (mm)		D ₁ (mm)	D ₂ (mm)	H (mm)	L (mm)	(g)	(pcs.)
14	1/2"	19.7	30	14	42	125	10
17		23.5	30	16	42	137	10
19		26	30	16	42	146	10
21		28	30	17	42	153	10
22		29.5	30	17	42	158	10
24		32	30	18	42	174	10
25.4		33.5	30	18	42	183	10

RS4127/6   Socket Set on Rail
Steckschlüsselsatz auf Schiene
Jeu de douilles sur rail



RS4127/6	6 Pieces Set/Rail 200mm	(g)
17, 19, 21, 22, 24, 25.4		960

4128 (L120)  NUTTWISTER® (Long type)

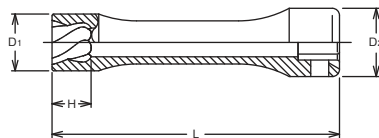

4128-120 (mm)		D ₁ (mm)	D ₂ (mm)	H (mm)	L (mm)	(g)	(pcs.)
17	1/2"	23.5	30	16	120	227	10
19		26	30	16	120	247	10
21		28	30	17	120	262	10
22		29.5	30	17	120	259	10

A very effective method and easy solution for removing rounded off nuts, bolts and studs. The sharp edges of the NUTTWISTER® Socket opening will tighten around the nut, bolt or stud and turn it easily off.

Eine einfache und wirkungsvolle Methode rund gedrehte Muttern und Bolzen herausdrehen bzw. zu öffnen. Die scharfen Kanten der gewundenen NUTTWISTER® Öffnung setzen sich um die Mutter bzw. den Schraubenkopf und drehen sie problemlos heraus.

Il existe une méthode simple mais efficace pour retirer les écrous et les boulons arrondis ainsi que les goujons et les dispositifs de verrouillage des jantes. Les arêtes vives de la douille NUTTWISTER® vont «mordre» l'écrou, le boulon ou le goujon et permettre ainsi facilement son extraction.



3129-32 (mm)		D ₁ (mm)	D ₂ (mm)	L (mm)	(g)	(pcs.)
2	3/8"	2	19	32	32	10
3		3	19	32	33	10
4		4	19	32	33	10
6		6	19	32	35	10
8		8	19	32	37	10
10		10	19	32	40	10

3129-60 (mm)		D ₁ (mm)	D ₂ (mm)	L (mm)	(g)	(pcs.)
2	3/8"	2	19	60	38	10
3		3	19	60	42	10
4		4	19	60	44	10
6		6	19	60	47	10
8		8	19	60	53	10
10		10	19	60	64	10

RS3129/6-L32	6 Pieces Set/Rail 150mm	(g)
2, 3, 4, 6, 8, 10		250

RS3129/6-L60	6 Pieces Set/Rail 150mm	(g)
2, 3, 4, 6, 8, 10		320

4129-37 (mm)		D ₁ (mm)	D ₂ (mm)	L (mm)	(g)	(pcs.)
8	1/2"	8	24	37	59	10
10		10	24	37	63	10
12		12	24	37	67	10
14		14	24	37	72	10
16		16	24	37	78	10

4129-75 (mm)		D ₁ (mm)	D ₂ (mm)	L (mm)	(g)	(pcs.)
8	1/2"	8	24	75	80	10
10		10	24	75	94	10
12		12	24	75	110	10
14		14	24	75	130	10
16		16	24	75	150	10

RS4129/5-L37	5 Pieces Set/Rail 150mm	(g)
8, 10, 12, 14, 16		370

RS4129/5-L75	5 Pieces Set/Rail 150mm	(g)
8, 10, 12, 14, 16		600

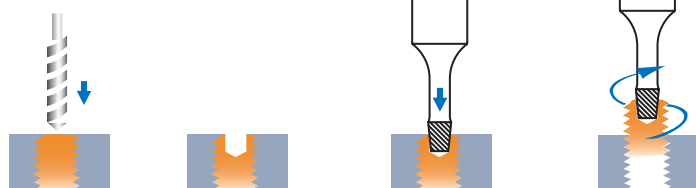

Effective method and easy solution for removing twisted off bolt. Drill a hole in the center of bolt and drive BOLTTWISTER® firmly into the hole. The sharp spiral edges will hold the broken bolt and easily remove it.



3129-32 / -60 BOLTTWISTER®

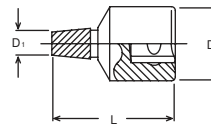

RS3129/6-L32 / -L60 Socket Set on Rail

Steckschlüsselsatz auf Schiene
Jeu de douilles sur rail



4129-37 / -75 BOLTTWISTER®

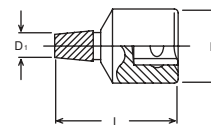

RS4129/5-L37 / -L75 Socket Set on Rail

Steckschlüsselsatz auf Schiene
Jeu de douilles sur rail



BOLTTWISTER	Bolt size	Drill size
2	M5	φ 2.4 ~ 2.6
3	M6	φ 3.2 ~ 3.5
4	M8	φ 4.2 ~ 4.5
6	M10 ~ M12	φ 6.2 ~ 6.5
8	M14 ~ M16	φ 8.2 ~ 8.5
10	M18 ~ M20	φ 10.2 ~ 10.5
12	M22 ~ M24	φ 12.2 ~ 12.5
14	M27 ~ M30	φ 14.2 ~ 14.5
16	M33	φ 16.2 ~ 16.5

Ratcheting Ring Spanners

Knarren-Ringschlüssel

Clés hexagonales à cliquet

Z-SERIES
HAND
TITANIUM
ACCESSORIES
SCREWDRIVERS
IMPACT
SLEEVE-DRIVE
PROTECTOR
INDUSTRIAL
AUTOMOTIVE
MOTORCYCLE
CONSTRUCTION
SPARE PART

102NM / 102NA Without reverse lever Nicht umstellbar Non réversible

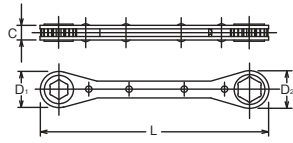

102NM (mm)	L (mm)	D ₁ (mm)	D ₂ (mm)	C (mm)	(g)	(pcs.)
6×7	108	15.3	16.4	7.5	60	10
7×8	108	15.3	16.4	7.5	60	10
8×9	134	17.1	19.7	7.5	80	10
8×10	134	17.1	19.7	7.5	80	10
10×11	140	20.1	22.7	7.5	87	10
10×12	140	20.1	22.7	7.5	87	10
11×13	145	23.6	24.6	9	112	10
12×13	145	23.6	24.6	9	112	10
12×14	145	23.6	24.6	9	112	10

102NA (inch)	L (mm)	D ₁ (mm)	D ₂ (mm)	C (mm)	(g)	(pcs.)
7/32 × 1/4	108	15.3	16.4	7.5	60	10
1/4 × 9/32	108	15.3	16.4	7.5	60	10
1/4 × 5/16	108	15.3	16.4	7.5	60	10
5/16 × 11/32	134	17.1	19.7	7.5	80	10
5/16 × 3/8	134	17.1	19.7	7.5	80	10
3/8 × 7/16	140	20.1	22.7	7.5	87	10
7/16 × 1/2	145	23.6	24.6	9	112	10
1/2 × 9/16	145	23.6	24.6	9	112	5

102KM / 102KA Reversible Umstellbar Réversible

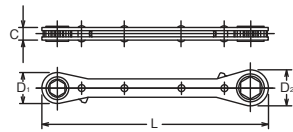

102KM (mm)	L (mm)	D ₁ (mm)	D ₂ (mm)	C (mm)	(g)	(pcs.)
6×7	108	15.3	16.4	7.2	51	10
7×8	108	15.3	16.4	7.2	51	10
8×9	134	17	20	9.1	76	10
8×10	134	17	20	9.1	76	10
10×11	141	21	23.5	9.1	84	10
10×12	141	21	23.5	9.1	84	10
12×13	146	24	25	9.1	89	10
12×14	146	24	25	9.1	89	5
13×17	200	27.1	31.8	11.5	190	5
14×17	200	27.1	31.8	11.5	200	5

102KA (inch)	L (mm)	D ₁ (mm)	D ₂ (mm)	C (mm)	(g)	(pcs.)
7/32 × 1/4	108	15.3	16.4	7.2	51	10
1/4 × 5/16	108	15.3	16.4	7.2	51	10
5/16 × 11/32	134	17	20	9	76	10
3/8 × 7/16	141	21	23.5	9.1	84	10
1/2 × 9/16	146	24	25	9.1	89	5

102KM.BH With Twin Openings (Two-in-One) Doppel-Ringschlüssel (zwei Öffnungen in einer) Ouvertures doubles

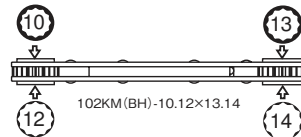

102KM.BH (mm)	L (mm)	D ₁ (mm)	D ₂ (mm)	C (mm)	(g)	(pcs.)
5.5- 6x 7- 8	108	15.3	16.4	10	60	10
8 ·10x12·13	141	21	23.5	13	87	10
9 ·10x11·12	141	21	23.5	13	87	10
10 ·12x13·14	146	24	25	13	98	10
13 ·14x15·17	200	27.1	31.8	16	200	5

102KT Reversible TORX® Umstellbar TORX® Réversible TORX®



102KT (E)	L (mm)	D ₁ (mm)	D ₂ (mm)	C (mm)	(g)	(pcs.)
E 4×E 6	108	15.3	16.4	7.5	51	10
E 6×E 8	108	15.3	16.4	7.5	51	10
E10×E12	134	17	20	9	76	10

TORX is a registered trademark of CAMCAR Innovations.
TORX ist ein registriertes Markenzeichen der Firma CAMCAR Innovations.
TORX est une marque déposée de CAMCAR Innovations.

103KM (mm)	L (mm)	D ₁ (mm)	D ₂ (mm)	C (mm)	(g)	(pcs.)
6× 7	108	15.3	16.4	7.5	51	5
7× 8	108	15.3	16.4	7.5	51	5
8× 9	134	17	20	9	76	5
8×10	134	17	20	9	76	5
10×11	140	21	23.5	9	84	5
10×12	140	21	23.5	9	84	5
12×13	145	24	25	9	89	5
12×14	145	24	25	9	89	5

103KA (inch)	L (mm)	D ₁ (mm)	D ₂ (mm)	C (mm)	(g)	(pcs.)
7/32× 1/4	108	15.3	16.4	7.5	51	5
1/4 × 5/16	108	15.3	16.4	7.5	51	5
5/16×11/32	134	17	20	9	76	5
5/16× 3/8	134	17	20	9	76	5
3/8 × 7/16	140	21	23.5	9	84	5
7/16× 1/2	145	24	25	9	89	5
1/2 × 9/16	145	24	25	9	89	5

103KA.BH (inch)	L (mm)	D ₁ (mm)	D ₂ (mm)	C (mm)	(g)	(pcs.)
1/4×5/16	108	15.3	16.4	7.5	51	5
3/8×7/16	140	21	23.5	9	84	5
1/2×9/16	145	24	25	9	89	5

103KT (E)	L (mm)	D ₁ (mm)	D ₂ (mm)	C (mm)	(g)	(pcs.)
E 4×E 6	104	15.3	16.4	7.5	51	5
E 6×E 8	104	15.3	16.4	7.5	51	5
E10×E12	128	17	20	9	76	5
E14×E16	139	24	25	9	89	5

145KM (mm)	L (mm)	D (mm)	C (mm)	(g)	(pcs.)
10H	125	20.1	7.5	72	10



150-10H (mm)	D (mm)	H (mm)	L (mm)	(g)	(pcs.)
5	12	3.5	11	6	10
6	12	4.5	12.5	7	10
7	12	5	14	7	10
8	12	6	15.5	7	10
9	13	6	16	7	10
10	14.3	7	17	9	10
12	17.4	9	19.5	14	10

1203		7 Pieces Set/△=250g
METAL CASE:W130×H65×T20mm		
Sockets		Accessory
150.10H 5, 6, 7, 8, 9, 10	145KM-10H	

103KM / 103KA Reversible
Umstellbar
Réversible

103KA.BH Reversible (12P)
Umstellbar (12P)
Réversible (12P)

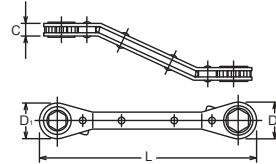

103KT Reversible TORX®
Umstellbar TORX®
Réversible TORX®

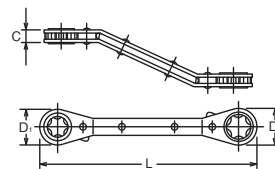

145KM-10H Reversible, 10mm 6-pt.
Verstellbar SW10mm
Réversible 10mm

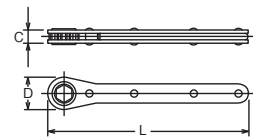

150-10H Sockets with 10mm 6-point Drive End
Steckschlüssel mit 10mm Sechskant-Antrieb
Douilles à conducteur de 10mm 6-pans mâle

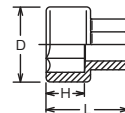

1203 Sockets with 10mm 6-point Drive End in Set with Ratchet
Steckschlüssel mit 10mm Sechskant-Antrieb mit Knarre im Satz
Jeu de douilles à conducteur 10mm 6-pans mâle, avec cliquet





Ratcheting Ring Spanners
 Knarren-Ringschlüssel
 Clés hexagonales à cliquet

Z-SERIES
 HAND
 TITANIUM
 ACCESSORIES
 SCREWDRIVERS
 IMPACT
 SLEEVE-DRIVE
 PROTECTOR
 INDUSTRIAL
 AUTOMOTIVE
 MOTORCYCLE
 CONSTRUCTION
 SPARE PART

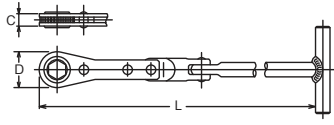

154M  Push and Pull-Ratchets
 Hub-Knarren
 Clé à cliquet de levage



154M (mm)	L (mm)	D (mm)	C (mm)	 (g)	 (pcs.)
8	294	17.1	7.5	178	2
10	297	20.1	7.5	183	2
12	300	23.6	9	189	2
13	301	24.6	9	194	2
14	301	24.6	9	194	2



154ML  Push and Pull-Ratchets
 Hub-Knarren
 Clé à cliquet de levage

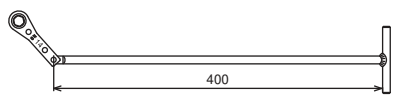

154ML (mm)	L (mm)	D (mm)	C (mm)	 (g)	 (pcs.)
10	297	20.1	7.5	230	2
12	300	23.6	9	252	2

1206  Push and Pull-Ratchet
 Hub-Knarre
 Clé à cliquet de levage



1206		3 Pieces Set/  =320g
CARDBOARD BOX		
Sockets		Accessory
 150.14H Sockets 12, 14	154K-14	



Ratcheting Ring Spanners Knarren-Ringschlüssel Clés hexagonales à cliquet

137	L (mm)	D ₁ (mm)	D ₂ (mm)	C (mm)	(g)	(pcs.)
	141	23.5	21	9	104	5

1/4" × 3/8"

138	L (mm)	D ₁ (mm)	D ₂ (mm)	C (mm)	(g)	(pcs.)
	141	23.5	21	9	97	10

1/4" × 1/4"

139	L (mm)	D (mm)	C (mm)	(g)	(pcs.)
	125	20.1	7.5	80	10

1/4"

R810 (inch)	L (mm)	D ₁ (mm)	D ₂ (mm)	C (mm)	(g)	(pcs.)
1/4×5/16	108	15.3	16.4	7.5	60	10
3/8×7/16	140	20.1	22.7	7.5	87	10
1/2×9/16	145	23.6	24.6	9	112	10

137  For 1/4" and 3/8" Square Drive Sockets
Für Steckschlüssel mit 1/4" und 3/8" Antrieb
Pour douilles d'un carré conducteur de 1/4" et 3/8"

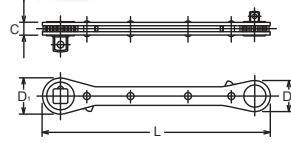

138  For Bits 101
Für Klingen 101
Pour embouts 101

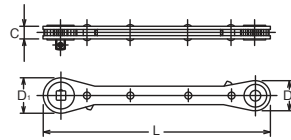

139  For 1/4" Square Drive Sockets
Für Steckschlüssel mit 1/4" Antrieb
Pour douilles d'un carré conducteur de 1/4"

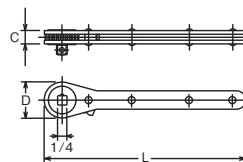

R810  Reversible (12P)
Umstellbar (12P)
Réversible (12P)



Z-SERIES
HAND
TITANIUM
ACCESSORIES
SCREWDRIVERS
IMPACT
SLEEVE-DRIVE
PROTECTOR
INDUSTRIAL
AUTOMOTIVE
MOTORCYCLE
CONSTRUCTION
SPARE PART

Ratcheting Ring Spanners

Knarren-Ringschlüssel

Clés hexagonales à cliquet

Z-SERIES
HAND
TITANIUM
ACCESSORIES
SCREWDRIVERS
IMPACT
SLEEVE-DRIVE
PROTECTOR
INDUSTRIAL
AUTOMOTIVE
MOTORCYCLE
CONSTRUCTION
SPARE PART

101P PH Bits PH Bits Embouts, PH

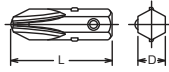

101P (PH)	D (mm)	L (mm)	(g)	(pcs.)
1	6.35	20.5	3	10
2	6.35	20.5	4	10
3	6.35	20.5	5	10

101S Slotted Bits Schlitz Bits Embouts, fente

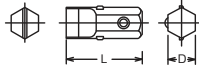

101S	D (mm)	L (mm)	(g)	(pcs.)
1.0x7	6.35	15	3	10
1.2x7	6.35	15	3	10

101H Hex Bits Sechskant Bits Embouts, 6 pans creux

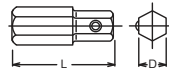

101H (mm)	D (mm)	L (mm)	(g)	(pcs.)
3	6.35	20.5	5	10
4	6.35	20.5	5	10
5	6.35	20.5	5	10
6	6.35	20.5	5	10
7	6.35	20.5	6	10
8	6.35	20.5	7	10

101B Ball-point Hex Bits Sechskant Bits Embouts, 6 pans creux

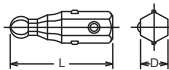

101B (mm)	D (mm)	L (mm)	(g)	(pcs.)
3	6.35	25	4	10
4	6.35	25	4	10
5	6.35	25	5	10
6	6.35	25	5	10

 Ball point bits have less strength due to the special design. Make sure to use them correctly.

101T (T) TORX® Bits TORX® Bits Embouts, TORX®

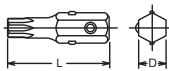

101T (T)	D (mm)	L (mm)	(g)	(pcs.)
T 9	6.35	25	4	10
T10	6.35	25	4	10
T15	6.35	25	5	10
T20	6.35	25	5	10
T25	6.35	25	5	10
T27	6.35	25	6	10
T30	6.35	25	6	10

101T (TH) Tamper-Resistant TORX® Bits TORX® Bits Embouts, TORX®

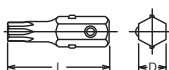

101T (TH)	D (mm)	L (mm)	(g)	(pcs.)
T10H	6.35	25	4	10
T15H	6.35	25	4	10
T20H	6.35	25	5	10
T25H	6.35	25	5	10
T27H	6.35	25	6	10
T30H	6.35	25	6	10

 Tamper Resistant TORX® Bits have less strength due to special design. Make sure to use it correctly.

128H (mm)	D (mm)	L (mm)	(g)	(pcs.)
3	8	32	11	10
4	8	32	11	10
5	8	32	12	10
6	8	32	12	10
8	8	32	13	10

128T (T)	D (mm)	L (mm)	(g)	(pcs.)
T10	8	32	9	10
T15	8	32	9	10
T20	8	32	9	10
T25	8	32	10	10
T27	8	32	10	10
T30	8	32	11	10

101A	D (mm)	S (mm)	L (mm)	(g)	(pcs.)
	8	6.35	20	8	10

128H Hex Bits
Sechskant Bits
Embouts, 6 pans creux

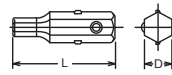

128T TORX® Bits
TORX® Bits
Embouts, TORX®

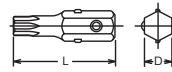

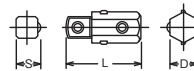

101A Adaptor
Verbindungsstück
Adaptateur



1202		15 Pieces Set/△=420g
METAL CASE:W190×H60×T30mm		
Bits	Accessory	
<p>101P PH Bits 1, 2, 3</p> <p>101S Slotted Bit 1×7</p> <p>101B Ballpoint Hex Bits 3, 4, 5, 6</p> <p>101T TORX® Bits T10, T15, T20, T25, T27, T30</p>	 138	

1202 Bit Set
Bit-Satz
Jeu d'embouts

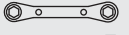
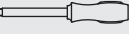

2254M		12 Pieces Set/△=450g
METAL CASE:W160×H100×T28mm		
Bits	Accessories	
<p>101P PH Bits 1, 2, 3</p> <p>101S Slotted Bits 1×7, 1.2×7</p> <p>101H Hex Bits 3, 4, 5</p>	 102NA-1/4×5/16  2769F  101A  2137	

2254M Bit Set
Bit-Satz
Jeu d'embouts



Ratcheting Ring Spanners Knarren-Ringschlüssel Clés hexagonales à cliquet

Z-SERIES
HAND
TITANIUM
ACCESSORIES
SCREWDRIVERS
IMPACT
SLEEVE-DRIVE
PROTECTOR
INDUSTRIAL
AUTOMOTIVE
MOTORCYCLE
CONSTRUCTION
SPARE PART

R810A Bit Set
Bit-Satz
Jeu d'embouts



R810A 5 Pieces Set/△=208g	
METAL CASE:W130×H65×T20mm	
Bits	Accessory
101P PH Bits 1, 2, 3 101S Slotted Bit 1×7	102NA-1/4×5/16

R810B Bit Set
Bit-Satz
Jeu d'embouts



R810B 10 Pieces Set/△=268g	
METAL CASE:W130×H65×T20mm	
Bits	Accessory
101P PH Bits 1, 2, 3 101S Slotted Bit 1×7 128H Hex Bits 3, 4, 5, 6, 8	102NA-1/4×5/16

R810C Bit and Socket Set
Bit und Steckschlüssel Satz
Jeu de douilles et d'embouts



R810C 12 Pieces Set/△=227g	
METAL CASE:W130×H65×T20mm	
Bits, Sockets	Accessories
101P PH Bits 1, 2, 3 101S Slotted Bit 1×7 2400M Sockets 5, 6, 7, 8, 9, 10	102NA-1/4×5/16 101A

R810D Bit and Socket Set
Bit und Steckschlüssel Satz
Jeu de douilles et d'embouts



R810D 17 Pieces Set/△=336g	
METAL CASE:W130×H65×T20mm	
Bits, Sockets	Accessories
101P PH Bits 1, 2, 3 101S Slotted Bit 1×7 128H Hex Bits 3, 4, 5, 6, 8 2400M Sockets 5, 6, 7, 8, 9, 10	102NA-1/4×5/16 101A

R810E Socket Set
Steckschlüssel Satz
Jeu de clés à douilles



R810E 9 Pieces Set/△=445g	
METAL CASE:W130×H65×T20mm	
Sockets	Accessories
2300M Deep Sockets 6, 7, 8, 9, 10, 11, 12	102NA-1/4×5/16 101A



156M  6-Point Deep
6-kant, lang
Longues 6-pans

156M (mm)	D (mm)	H ₁ (mm)	H ₂ (mm)	L ₁ (mm)	L ₂ (mm)	(g)	(pce.)
8	12	9	41	355	200	231	1
10	14.5	11	41	355	200	289	1
12	16.8	13	41	355	200	429	1
14	20	16	41	355	200	454	1

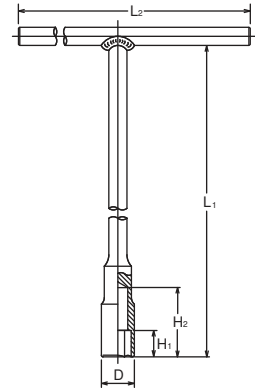

104ME / 104A  6-Point
6-kant
6-pans

104ME (mm)	D (mm)	H (mm)	L ₁ (mm)	L ₂ (mm)	(g)	(pce.)
6	9.5	8	200	180	150	1
7	11	9	200	180	152	1
8	12	10	250	200	183	1
9	14	12	250	200	188	1
10	14	13	250	200	230	1
11	16	14	250	200	234	1
12	18	15	250	200	355	1
13	18.5	17	250	250	390	1
14	20	18	250	250	399	1
15	21	19	250	250	404	1
16	22.5	21	250	250	419	1
17	24	22	250	250	568	1
18	25	23	250	250	577	1
19	26.5	25	250	250	594	1

104A (inch)	D (mm)	H (mm)	L ₁ (mm)	L ₂ (mm)	(g)	(pce.)
1/4	9.5	8	200	180	150	1
5/16	12	10	250	200	183	1
3/8	14	12	250	200	188	1
7/16	16	14	250	200	234	1
1/2	18.5	17	300	250	412	1
9/16	20	18	300	250	428	1
5/8	22.5	21	350	300	528	1
3/4	26.5	25	350	300	717	1

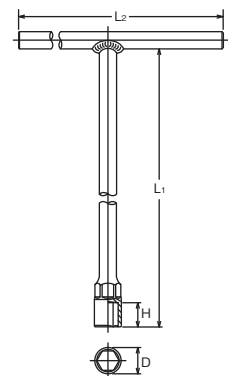

Z-SERIES
HAND
TITANIUM
ACCESSORIES
SCREWDRIVERS
IMPACT
SLEEVE-DRIVE
PROTECTOR
INDUSTRIAL
AUTOMOTIVE
MOTORCYCLE
CONSTRUCTION
SPARE PART

3116M  Universal with 6-point Socket
Gelenk mit 6-kant Steckschlüssel
Cardan avec douille 6-pans



124M-600 (2B)

 Ball Joint plus Nut Grip Socket
Kugelgelenk mit 2-facher Kugelhalterung
Douilles articulées avec deux billes de retenue

3116M (mm)	D (mm)	H (mm)	L ₁ (mm)	L ₂ (mm)	(g)	(pce.)
10	14.5	8	800	190	796	1
12	17	10.3	800	190	797	1
13	18	11.3	800	190	797	1
14	19.5	11.3	800	190	797	1
15	21	12.8	800	190	799	1
16	22	12.8	800	190	806	1
17	23.6	13.8	800	190	801	1
18	24	13.8	800	190	809	1

124M-600 (mm)	D (mm)	H (mm)	L ₁ (mm)	L ₂ (mm)	(g)	(pce.)
8(2B)	12	5	600	200	332	1
10(2B)	14.5	6	600	200	334	1
12(2B)	16.8	7	600	200	424	1
13(2B)	18	8	600	200	425	1
14(2B)	19.5	8.5	600	200	527	1
17(2B)	23.3	9.5	600	200	538	1

NUT GRIP®

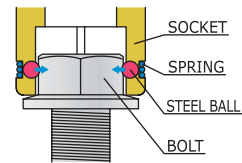

NUT GRIP®

Twin balls at the 6-point opening hold bolt/nut tightly for safe and reliable work.
Die zwei Kugeln in der 6-kant Öffnung unserer NUT GRIP Steckschlüssel halten die Schraube sicher im Steckschlüssel. Dies erlaubt ein Arbeiten auch an schwer zugänglichen Stellen.
Les 2 billes dans l'ouverture du 6-pans de la douille retiennent l'écrou de manière sûre et efficace.

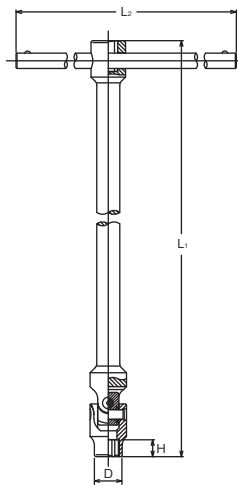

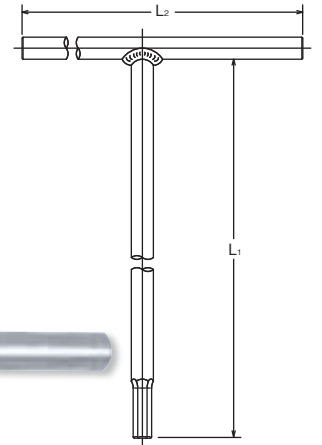

photo: 3116M

157HE  For Inhex Screws
Für Innensechskant-Schrauben
Pour vis à 6-pans creux

157HE (mm)	L ₁ (mm)	L ₂ (mm)	(g)	(pce.)
3	250	180	98	1
4	250	180	121	1
5	250	180	158	1
6	250	180	416	1
8	250	180	422	1
10	300	190	440	1
12	320	210	660	1



157T  For TORX® Screws
Für TORX®-Schrauben
Pour vis TORX®

157T (T)	L ₁ (mm)	L ₂ (mm)	(g)	(pce.)
T25	250	180	95	1
T27	250	180	96	1
T30	250	180	167	1
T40	250	180	168	1
T45	250	180	213	1
T50	250	180	215	1



157S  For Slotted Heads
Für Schlitzschrauben
Pour vis à fente

157S	T×W	L ₁ (mm)	L ₂ (mm)	(g)	(pce.)
6	1.0×6	200	180	84	1
8	1.2×8	250	180	170	1



157PE  For PH Screws
Für Kreuzschlitzschrauben, PH
Pour vis à empreinte PH

157PE (PH)	L ₁ (mm)	L ₂ (mm)	(g)	(pce.)
2	250	180	95	1
3	250	180	170	1

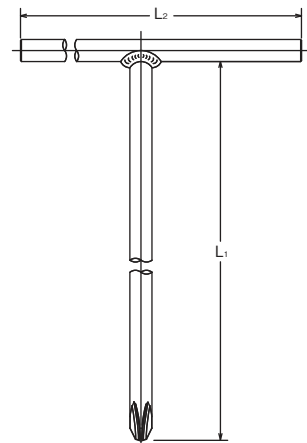
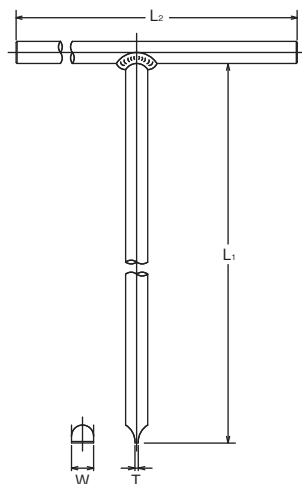

T-Handles
T-Griffe
Poignées en T

Z-SERIES
HAND
TITANIUM
ACCESSORIES
SCREWDRIVERS
IMPACT
SLEEVE-DRIVE
PROTECTOR
INDUSTRIAL
AUTOMOTIVE
MOTORCYCLE
CONSTRUCTION
SPARE PART

2715  T-Handle
T-Griff
Poignée coulissante



3715  T-Handle
T-Griff
Poignée coulissante



3715S  T-Handle
T-Griff
Poignée coulissante



3715SL  T-Handle
T-Griff
Poignée coulissante



OVAL SHAPE SHANK



3715SLK  T-Handle
T-Griff
Poignée coulissante







3716  T-Handle
T-Griff
Poignée coulissante

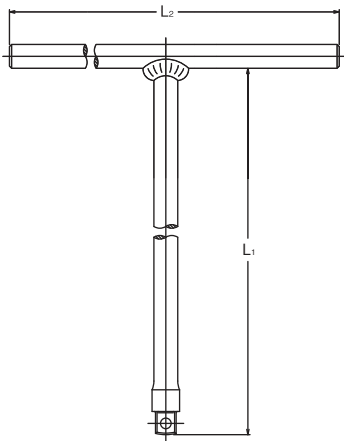

WOBBLE-FIX EXTENSION BAR



		L ₁ (mm)	L ₂ (mm)	 (g)	 (pce.)
2715		200	120	130	1

		L ₁ (mm)	L ₂ (mm)	 (g)	 (pce.)
3715		268	240	386	1
3715S		268	190	347	1
3715SL		237	200	325	1
3715SLK		236	200	470	1
3716		268	240	379	1

3716
3716 has a reduced square drive and similar function as offset extension bars.



photo: 3715SLK



4715  T-Handle
T-Griff
Poignée coulissante







4715S  T-Handle
T-Griff
Poignée coulissante

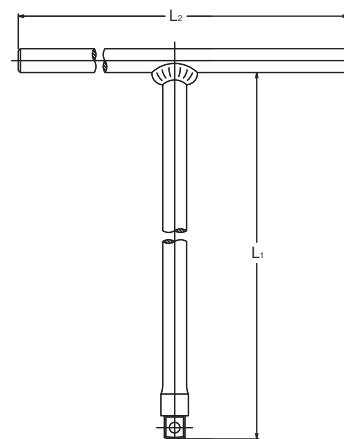

4715SL  T-Handle
T-Griff
Poignée coulissante



		L ₁ (mm)	L ₂ (mm)	 (g)	 (pce.)
4715		267	255	475	1
4715S		267	170	402	1
4715SL		250	250	640	1

4711X  Spinning cross wrench
T-Griff für die Radmuttermontage
Poignée coulissante pour montage des écrous à roue

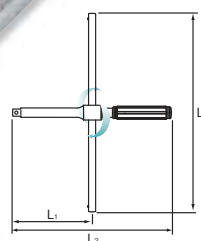
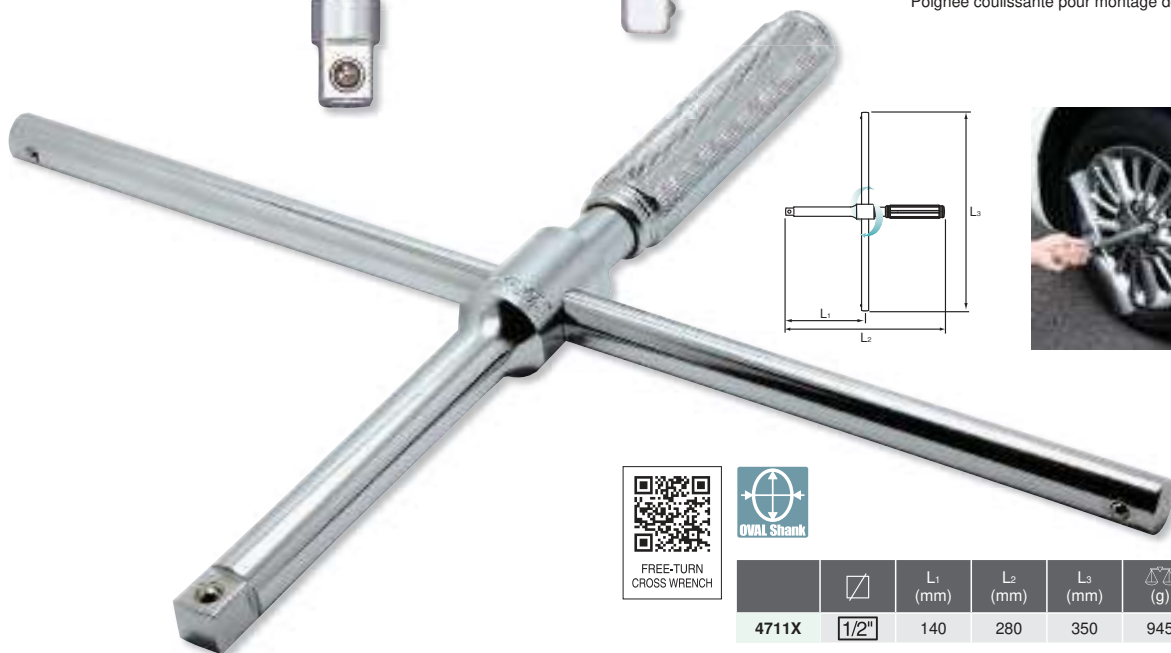

		L ₁ (mm)	L ₂ (mm)	L ₃ (mm)	 (g)	 (pce.)
4711X		140	280	350	945	1

Attack Drivers

Hand-Schlagschrauber

Tournevis à frapper

Z-SERIES
HAND
TITANIUM
ACCESSORIES
SCREWDRIVERS
IMPACT
SLEEVE-DRIVE
PROTECTOR
INDUSTRIAL
AUTOMOTIVE
MOTORCYCLE
CONSTRUCTION
SPARE PART

3112G Attack Driver
Handschlagschrauber
Tournevis à frapper



	□	L (mm)	⚖ (g)	📦 (pce.)
3112G	3/8"	159	810	1

4112G Attack Driver
Handschlagschrauber
Tournevis à frapper



	□	L (mm)	⚖ (g)	📦 (pce.)
4112G	1/2"	163	810	1
4112N	1/2"	163	730	1

* 4112N Renewal Kits → **4112RK** → P307

4112N Attack Driver
Handschlagschrauber
Tournevis à frapper



	□	L (mm)	⚖ (g)	📦 (pce.)
6112	3/4"	190	1900	1

* Renewal Kits → **6112RK** → P307



Black finished striking head prevents the problem of peeling.
Das geschwärzte Schlagende vermeidet das Abspringen von Chromteilen.
La finition "black finish" de la tête évite l'écaillage du au chromage.





6112 Attack Driver
Handschlagschrauber
Tournevis à frapper

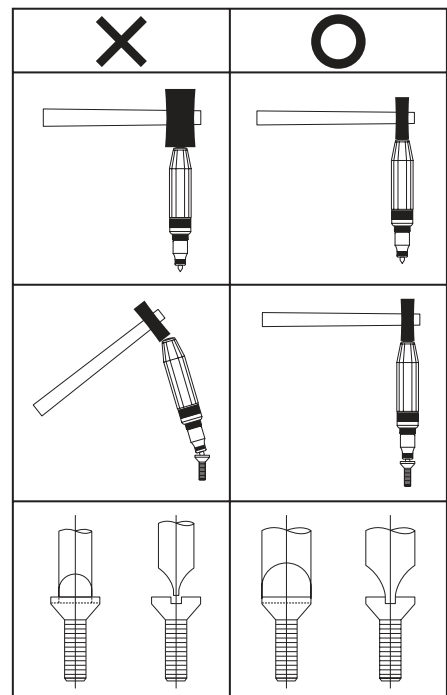





ATTACK DRIVER®



AG318A 6 Pieces Set/△=1,150g
METAL CASE:W220×H82×T60mm







Bits	Accessories
 100P.32 PH Bits 2, 3	 3112G
 100S.32 Slotted Bits 9, 11	 3138

AG112A 6 Pieces Set/△=1,150g
METAL CASE:W220×H82×T60mm

Bits	Accessories
 100P.32 PH Bits 2, 3	 4112G
 100S.32 Slotted Bits 9, 11	 4138









100P, S Bits →P158

AG112H 18 Pieces Set/△=1,480g
METAL CASE:W220×H82×T60mm

Bits	Accessories
 100P.32 PH Bits 2, 3, 4	 4112G
 100S.32 Slotted Bits 8, 9, 10, 12, 14	 4138
 100H.32 Hex Bits 5, 6, 8, 10	
 100T.32 TORX® Bits T30, T40, T45, T50	





100P, S, H, T Bits →P158

AG112F 25 Pieces Set/△=1,530g
METAL CASE:W220×H82×T60mm

Bits	Accessories
 100P.32 PH Bits 2, 3	 4112G
 100P.32 PZ Bits PZ2, PZ3	 4138
 100S.32 Slotted Bits 9, 11	
 100H.32 Hex Bits 4, 5, 6, 7, 8, 10	
 100T.32 TORX® Bits T25, T27, T30, T40, T45, T50	
 100X.32 XZN Bits M5, M6, M8, M10, M12	





100P, S, H, T, X Bits →P158-159

AN112A 6 Pieces Set/△=1,070g
METAL CASE:W190×H59×T45mm

Bits	Accessories
 100P.32 PH Bits 2, 3	 4112N
 100S.32 Slotted Bits 9, 11	 4138

100P, S Bits →P158

AN112C 8 Pieces Set/△=1,350g
METAL CASE:W220×H82×T60mm

Bits	Accessories
 100P.80 PH Bits 1, 2, 3	 4112N
 100S.80 Slotted Bits 7, 9, 12	 4138

100P, S Bits →P158

AG318A Attack Driver Set
Handschlagschrauber-Satz
Jeu de tournevis à frapper



AG112H Attack Driver Set
Handschlagschrauber-Satz
Jeu de tournevis à frapper

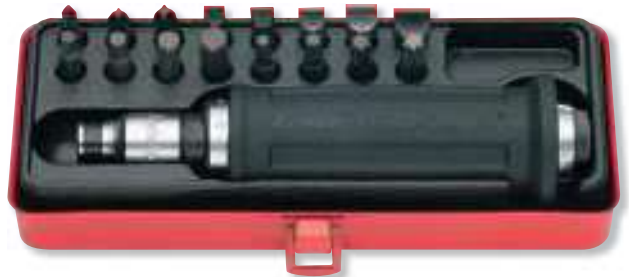

AG112F Attack Driver Set
Handschlagschrauber-Satz
Jeu de tournevis à frapper



AN112A Attack Driver Set
Handschlagschrauber-Satz
Jeu de tournevis à frapper



AN112C Attack Driver Set
Handschlagschrauber-Satz
Jeu de tournevis à frapper



Z-SERIES
HAND
TITANIUM
ACCESSORIES
SCREWDRIVERS
IMPACT
SLEEVE-DRIVE
PROTECTOR
INDUSTRIAL
AUTOMOTIVE
MOTORCYCLE
CONSTRUCTION
SPARE PART

108P-25 / -32 / -50  PH Bits
PH Bits
Embouts, PH

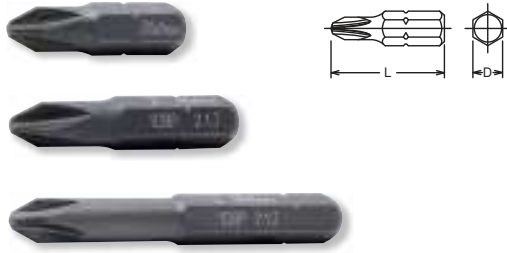

108S-25 / -39  Slotted Bits
Schlitz Bits
Embouts, fente

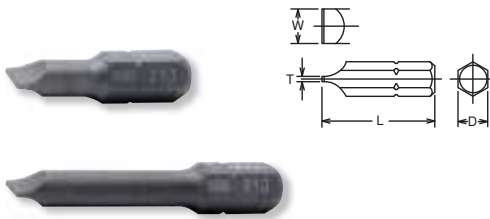

108H-25  Hex Bits
Sechskant Bits
Embouts, 6 pans creux



108T-25 (T)  TORX® Bits
TORX® Bits
Embouts, TORX®



108T-25 (TH)  Tamper-Resistant TORX® Bits
Tamper-Resistant TORX® Bits
Embouts TORX®, Tamper-Resistant 



 Tamper Resistant TORX® Bits have less strength due to special design.
Make sure to use it correctly.

108A  Adaptor
Verbindungsstück
Adaptateur



108P-25 (PH)	D (mm)	L (mm)	(g)	(pcs.)
1	6.35	25	5	10
2	6.35	25	5	10
3	6.35	25	6	10

108P-32 (PH)	D (mm)	L (mm)	(g)	(pcs.)
1	6.35	32	7	10
2	6.35	32	7	10
3	6.35	32	8	10

108P-50 (PH)	D (mm)	L (mm)	(g)	(pcs.)
1	6.35	50	10	10
2	6.35	50	11	10
3	6.35	50	11	10

108S-25	T×W (mm)	D (mm)	L (mm)	(g)	(pcs.)
3	0.5×3	6.35	25	3	10
4	0.6×4	6.35	25	3	10
4.5	0.6×4.5	6.35	25	4	10
5	0.8×5	6.35	25	5	10
5.5	0.8×5.5	6.35	25	5	10
6	1.0×6	6.35	25	5	10
8	1.2×8	6.35	25	6	10

108S-39	T×W (mm)	D (mm)	L (mm)	(g)	(pcs.)
3	0.5×3	6.35	39	6	10
4	0.6×4	6.35	39	6	10
4.5	0.6×4.5	6.35	39	6	10
5	0.8×5	6.35	39	7	10
5.5	0.8×5.5	6.35	39	8	10
6	1.0×6	6.35	39	9	10
8	1.2×8	6.35	39	12	10

108H-25 (mm)	D (mm)	L (mm)	(g)	(pcs.)
3	6.35	25	4	10
4	6.35	25	5	10
5	6.35	25	5	10
6	6.35	25	6	10
7	6.35	25	7	10
8	6.35	25	8	10
10	6.35	25	11	10

108H-25 (inch)	D (mm)	L (mm)	(g)	(pcs.)
1/8	6.35	25	4	10
9/64	6.35	25	5	10
5/32	6.35	25	5	10
3/16	6.35	25	5	10
7/32	6.35	25	6	10
1/4	6.35	25	7	10

108T-25 (T)	D (mm)	L (mm)	(g)	(pcs.)
T 8	6.35	25	4	10
T10	6.35	25	4	10
T15	6.35	25	4	10
T20	6.35	25	5	10
T25	6.35	25	6	10
T27	6.35	25	6	10
T30	6.35	25	6	10
T40	6.35	25	6	10

108T-25 (TH)	D (mm)	L (mm)	(g)	(pcs.)
T10H	6.35	25	4	10
T15H	6.35	25	4	10
T20H	6.35	25	5	10
T25H	6.35	25	6	10
T27H	6.35	25	6	10
T30H	6.35	25	6	10
T40H	6.35	25	6	10

108A-25	D (mm)	L (mm)	(g)	(pcs.)
1/4B	6.35	25	10	10

		D ₁ (mm)	D ₂ (mm)	L (mm)	(g)	(pcs.)
2137	1/4"	12	12	22.5	13	10
3137	3/8"	13	16.5	30	30	10
4137	1/2"	13	22	38	53	10

For DIN3126 C6.3 Bits
Für DIN3126 C6.3 Bits
Pour DIN3126 C6.3 Embouts

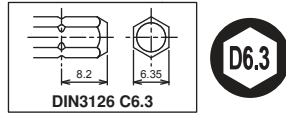

		D ₁ (mm)	D ₂ (mm)	L (mm)	(g)	(pcs.)	
12139	1/4"	11	13	25	15	10	*1
13139	3/8"	11	19	30	32	10	*2
14139	1/2"	11	25	35	62	10	*3

*1 Pin/O-Ring=A21/B21
*2 C-Ring=C31,Pin/O-Ring=A31/B31
*3 C-Ring=C41,Pin/O-Ring=A41/B41

→ P256-257

For DIN3126 C6.3 Bits
Für DIN3126 C6.3 Bits
Pour DIN3126 C6.3 Embouts



		D ₁ (mm)	D ₂ (mm)	L (mm)	(g)	(pcs.)	
13142-D6.3	3/8"	16	19	45	60	10	*1
14142-D6.3	1/2"	16	25	55	97	10	*2

*1 C-Ring=C31,Pin/O-Ring=A31/B31
*2 C-Ring=C41,Pin/O-Ring=A41/B41

→ P256-257

For DIN3126 C6.3 Bits
Für DIN3126 C6.3 Bits
Pour DIN3126 C6.3 Embouts

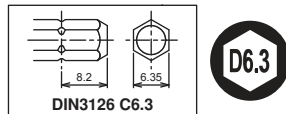

Lock & Quick Release

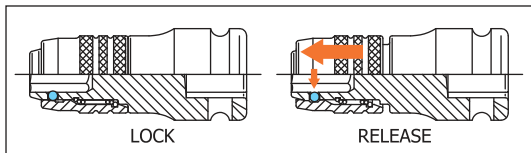

You may not hold the sliding part while moving to avoid heating up by friction and reduction by wear.

	D (mm)	H (mm)	L (mm)	(g)	(pcs.)
2749P-1/4HF	25	12	125	96	1
2774P-1/4HF	25	12	165	133	1

For DIN3126 C6.3 Bits
Für DIN3126 C6.3 Bits
Pour DIN3126 C6.3 Embouts

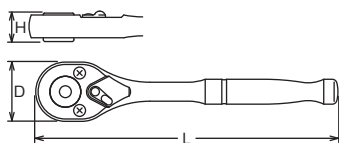
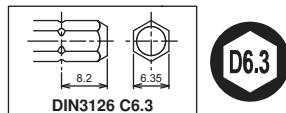

	D (mm)	H (mm)	L (mm)	(g)	(pcs.)
180M-50	11	13.5	50	15	10

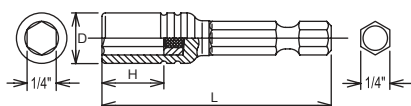

2137 Bit Holder
Klingenhalter
Porte-embouts
3137
4137

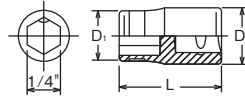

12139 Impact Bit Holder
Impact Klingenhalter
Porte embouts Impact
13139
14139

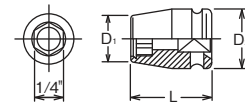

13142-D6.3 Impact Bit Holder
Impact Klingenhalter
Porte embouts Impact
14142-D6.3

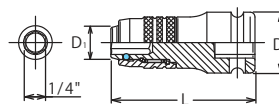

2749P-1/4HF Reversible Ratchet, for Bits 1/4"
Knarre, verstellbar, für Bits 1/4"
Cliquet, réversible pour embouts 1/4"



2774P-1/4HF Flexible Ratchet, reversible, for Bits 1/4"
Gelenk-Knarre, verstellbar, für Bits 1/4"
Cliquet à tête articulée pour embouts 1/4"

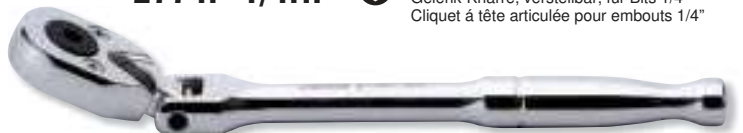

180M-50 Bit Holder with Magnet
Klingenhalter mit Magnet
Porte-embouts avec aimant



Z-SERIES
HAND
TITANIUM
ACCESSORIES
SCREWDRIVERS
IMPACT
SLEEVE-DRIVE
PROTECTOR
INDUSTRIAL
AUTOMOTIVE
MOTORCYCLE
CONSTRUCTION
SPARE PART

100P-32 / -80 / -125 PH Bits PH Bits Embouts, PH



100P-32 (PH)	D (mm)	L (mm)	(g)	(pcs.)
1	8	32	11	10
2	8	32	11	10
3	8	32	12	10
4	8	32	12	10

100P-80 (PH)	D (mm)	L (mm)	(g)	(pcs.)
1	8	80	30	10
2	8	80	30	10
3	8	80	31	10
4	8	80	32	10

100P-125 (PH)	D (mm)	L (mm)	(g)	(pcs.)
2	8	125	48	10
3	8	125	49	10

100P-32 (PZ) PZ Bits PZ Bits Embouts, PZ



100P-32 (PZ)	D (mm)	L (mm)	(g)	(pcs.)
PZ2	8	32	10	10
PZ3	8	32	11	10

100S-32 / -80 Slotted Bits Schlitz Bits Embouts, fente



100S-32	T x W (mm)	D (mm)	L (mm)	(g)	(pcs.)
6	1 x 6	8	32	10	10
7	1 x 7	8	32	11	10
8	1.2 x 8	8	32	12	10
9	1.6 x 9	8	32	12	10
10	1.6 x 10	8	32	13	10
11	1.6 x 11	8	32	15	10
12	2 x 12	8	32	18	10
14	2 x 14	8	32	21	10

100S-80	T x W (mm)	D (mm)	L (mm)	(g)	(pcs.)
6	1 x 6	8	80	29	10
7	1 x 7	8	80	30	10
8	1.2 x 8	8	80	31	10
9	1.6 x 9	8	80	32	10
10	1.6 x 10	8	80	33	10
11	1.6 x 11	8	80	33	10
12	2 x 12	8	80	34	10
14	2 x 14	8	80	37	10

100H-32 Hex Bits Sechskant Bits Embouts, 6 pans creux



100H-32 (mm)	D (mm)	L (mm)	(g)	(pcs.)
3	8	32	11	10
4	8	32	11	10
5	8	32	12	10
6	8	32	12	10
7	8	32	13	10
8	8	32	13	10
9	8	32	16	10
10	8	32	16	10
11	8	32	20	10
12	8	32	23	10
14	8	32	29	10

100T-32 (T) TORX® Bits TORX® Bits Embouts, TORX®



100T-32 (T)	D (mm)	L (mm)	(g)	(pcs.)
T10	8	32	9	10
T15	8	32	9	10
T20	8	32	9	10
T25	8	32	10	10
T27	8	32	10	10
T30	8	32	11	10
T40	8	32	12	10
T45	8	32	12	10
T50	8	32	12	10
T55	8	32	12	10

100T-32 (TH)	D (mm)	L (mm)	(g)	(pcs.)
T10H	8	32	9	10
T15H	8	32	9	10
T20H	8	32	9	10
T25H	8	32	10	10
T27H	8	32	10	10
T30H	8	32	11	10
T40H	8	32	12	10
T45H	8	32	12	10
T50H	8	32	12	10
T55H	8	32	12	10

100X-32	D (mm)	L (mm)	(g)	(pcs.)
M 5	8	32	10	10
M 6	8	32	11	10
M 8	8	32	12	10
M10	8	32	16	10
M12	8	32	19	10

		D ₁ (mm)	D ₂ (mm)	L (mm)	(g)	(pcs.)
2138	1/4"	16	16	26	32	10
3138	3/8"	16	18	38	55	10
4138	1/2"	16	22	38	62	10

For DIN3126 C8 Bits
Für DIN3126 C8 Bits
Pour DIN3126 C8 Embouts

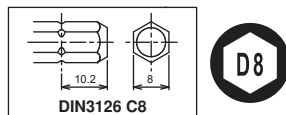

		D ₁ (mm)	D ₂ (mm)	L (mm)	(g)	(pcs.)	
12140	1/4"	14	13	25	15	10	*1
13140	3/8"	14	19	30	32	10	*2
14140	1/2"	14	25	35	62	10	*3

*1 Pin/O-Ring=A21/B21
*2 C-Ring=C31,Pin/O-Ring=A31/B31
*3 C-Ring=C41,Pin/O-Ring=A41/B41

→ P256-257

For DIN3126 C8 Bits
Für DIN3126 C8 Bits
Pour DIN3126 C8 Embouts

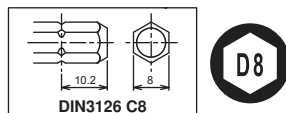

	D (mm)	H (mm)	L (mm)	(g)	(pcs.)
2749P-5/16HF	25	14	125	96	1
2774P-5/16HF	25	14	165	133	1

For DIN3126 C8 Bits
Für DIN3126 C8 Bits
Pour DIN3126 C8 Embouts

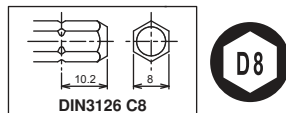

100T-32 (TH) Tamper-Resistant TORX® Bits Tamper-Resistant TORX® Bits Embouts TORX®, Tamper-Resistant

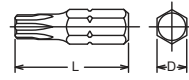

Tamper Resistant TORX® Bits have less strength due to special design.
Make sure to use it correctly.

100X-32 (XZN) XZN Bits XZN Bits Embouts, XZN

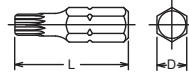

2138 Bit Holder Klingenhalter 3138 Porte-embouts 4138

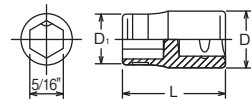

12140 Impact Bit Holder Impact Klingenhalter 13140 Porte embouts Impact 14140

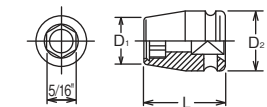

2749P-5/16HF Reversible Ratchet, for Bits 5/16" Knarre, verstellbar für Bits 5/16" Cliquet, réversible pour embouts 5/16"



2774P-5/16HF Flexible Ratchet, reversible, for Bits 5/16" Gelenk-Knarre, verstellbar, für Bits 5/16" Cliquet à tête articulée pour embouts 5/16"

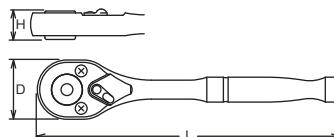
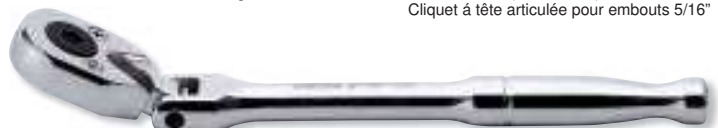

121P-50 / -70 / -100 / -150  PH Bits
PH Bits
Embout, PH

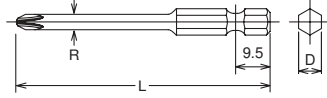

121P-50 (PH)	D (mm)	R (mm)	L (mm)	(g)	(pcs.)
1	6.35	4.5	50	12	10
2	6.35	5.5	50	12	10
3	6.35	-	50	13	10

121H-50 / -70 / -100 / -150  Hex Bits
Sechskant Bits
Embout, 6 pans creux

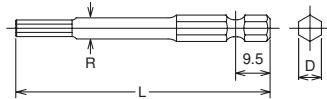

121H-50 (mm)	D (mm)	R (mm)	L (mm)	(g)	(pcs.)
2	6.35	3	50	11	10
2.5	6.35	3	50	12	10
3	6.35	3.5	50	12	10
4	6.35	4.5	50	12	10
5	6.35	5.6	50	13	10
6	6.35	-	50	14	10

121T-50 / -70 / -100 / -150 (T)  TORX® Bits
TORX® Bits
Embout, TORX®

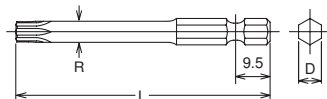

121T-50 (T)	D (mm)	R (mm)	L (mm)	(g)	(pcs.)
T10	6.35	3	50	12	10
T15	6.35	3.5	50	12	10
T20	6.35	4.1	50	12	10
T25	6.35	4.6	50	12	10
T27	6.35	5.2	50	13	10
T30	6.35	5.7	50	13	10
T40	6.35	-	50	14	10

121P-70 (PH)	D (mm)	R (mm)	L (mm)	(g)	(pcs.)
1	6.35	4.5	70	15	10
2	6.35	5.5	70	15	10
3	6.35	-	70	16	10

121P-100 (PH)	D (mm)	R (mm)	L (mm)	(g)	(pcs.)
1	6.35	4.5	100	23	10
2	6.35	5.5	100	23	10
3	6.35	-	100	24	10

121P-150 (PH)	D (mm)	R (mm)	L (mm)	(g)	(pcs.)
1	6.35	4.5	150	30	10
2	6.35	5.5	150	35	10
3	6.35	-	150	36	10

121H-70 (mm)	D (mm)	R (mm)	L (mm)	(g)	(pcs.)
2	6.35	3	70	13	10
2.5	6.35	3	70	15	10
3	6.35	3.5	70	15	10
4	6.35	4.5	70	15	10
5	6.35	5.6	70	16	10
6	6.35	-	70	18	10

121H-100 (mm)	D (mm)	R (mm)	L (mm)	(g)	(pcs.)
2	6.35	3	100	22	10
2.5	6.35	3	100	23	10
3	6.35	3.5	100	23	10
4	6.35	4.5	100	23	10
5	6.35	5.6	100	24	10
6	6.35	-	100	26	10

121H-150 (mm)	D (mm)	R (mm)	L (mm)	(g)	(pcs.)
2	6.35	3.5	150	35	10
2.5	6.35	3.5	150	35	10
3	6.35	3.5	150	37	10
4	6.35	4.5	150	37	10
5	6.35	5.6	150	38	10
6	6.35	-	150	39	10

121T-70 (T)	D (mm)	R (mm)	L (mm)	(g)	(pcs.)
T10	6.35	3.5	70	16	10
T15	6.35	3.5	70	16	10
T20	6.35	4.1	70	16	10
T25	6.35	4.6	70	16	10
T27	6.35	5.2	70	17	10
T30	6.35	5.7	70	17	10
T40	6.35	-	70	18	10

121T-100 (T)	D (mm)	R (mm)	L (mm)	(g)	(pcs.)
T10	6.35	3.5	100	24	10
T15	6.35	3.5	100	24	10
T20	6.35	4.1	100	24	10
T25	6.35	4.6	100	24	10
T27	6.35	5.2	100	24	10
T30	6.35	5.7	100	25	10
T40	6.35	-	100	26	10

121T-150 (T)	D (mm)	R (mm)	L (mm)	(g)	(pcs.)
T10	6.35	3.5	150	35	10
T15	6.35	3.5	150	37	10
T20	6.35	4.1	150	37	10
T25	6.35	4.6	150	37	10
T27	6.35	5.2	150	37	10
T30	6.35	5.7	150	38	10
T40	6.35	-	150	39	10

121T-70 (TH)	D (mm)	R (mm)	L (mm)	(g)	(pcs.)
T15H	6.35	3.5	70	15	10
T20H	6.35	4.1	70	16	10
T25H	6.35	4.6	70	16	10
T27H	6.35	5.2	70	17	10
T30H	6.35	5.7	70	17	10
T40H	6.35	-	70	18	10

121T-100 (TH)	D (mm)	R (mm)	L (mm)	(g)	(pcs.)
T15H	6.35	3.5	100	22	10
T20H	6.35	4.1	100	24	10
T25H	6.35	4.6	100	24	10
T27H	6.35	5.2	100	24	10
T30H	6.35	5.7	100	25	10
T40H	6.35	-	100	26	10

⚠ Tamper Resistant TORX® Bits have less strength due to special design. Make sure to use it correctly.

121T-50 (IP)	D (mm)	R (mm)	L (mm)	(g)	(pcs.)
20IP	6.35	4.1	50	12	10
25IP	6.35	4.6	50	12	10
27IP	6.35	5.2	50	13	10
30IP	6.35	5.7	50	13	10
40IP	6.35	-	50	14	10

121T-70 (IP)	D (mm)	R (mm)	L (mm)	(g)	(pcs.)
20IP	6.35	4.1	70	16	10
25IP	6.35	4.6	70	16	10
27IP	6.35	5.2	70	17	10
30IP	6.35	5.7	70	17	10
40IP	6.35	-	70	18	10

	□	D ₁ (mm)	D ₂ (mm)	L (mm)	(g)	(pcs.)	⚡
12137E	1/4"	12	13	36	22	10	*1
13137E	3/8"	12	19	40	40	10	*2
14137E	1/2"	12	25	48	70	10	*3

*1 Pin/O-Ring=A21/B21
 *2 C-Ring=C31, Pin/O-Ring=A31/B31
 *3 C-Ring=C41, Pin/O-Ring=A41/B41

→ P256-257

For DIN3126 E6.3 Bits
 Für DIN3126 E6.3 Bits
 Pour DIN3126 E6.3 Embouts

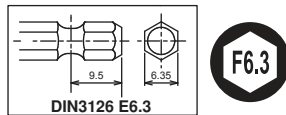

12137E, 13137E and 14147E can be used with various 1/4" bits, DIN 3126-C6.3, DIN 3126-E6.3 and Double ended type.

Die neuen Bithalter können für alle 1/4" Bits DIN 3126-C6.3, DIN 3126-E6.3 und für doppelseitige Bits verwendet werden.

Ces nouveaux porte embouts peuvent être utilisés avec tous les embouts 1/4" DIN 3126 E-6.3 et DIN 3126 C6.3

	□	D ₁ (mm)	D ₂ (mm)	L (mm)	(g)	(pcs.)	⚡
12142-F6.3	1/4"	16.5	13	40	22	10	*1
13142-F6.3	3/8"	16.5	19	45	60	10	*2
14142-F6.3	1/2"	16.5	25	55	100	10	*3

*1 Pin/O-Ring=A21/B21
 *2 C-Ring=C31, Pin/O-Ring=A31/B31
 *3 C-Ring=C41, Pin/O-Ring=A41/B41

→ P256-257

For DIN3126 E6.3 Bits
 Für DIN3126 E6.3 Bits
 Pour DIN3126 E6.3 Embouts

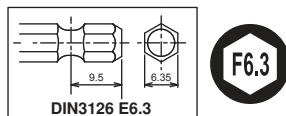

Lock & Quick Release

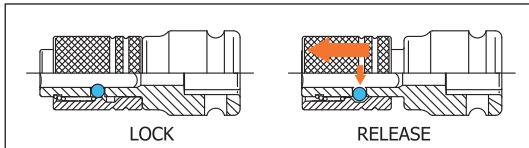

⚠ You may not hold the sliding part while moving to avoid heating up by friction and reduction by wear.

TORXplus is a registered trademark of CAMCAR Innovations.
 TORXplus ist ein registriertes Markenzeichen der Firma CAMCAR Innovations.
 TORXplus est une marque déposée de CAMCAR Innovations.

121T-70 / -100 (TH)

⚠ Tamper-Resistant TORX® Bits
 Tamper-Resistant TORX® Bits
 Embouts TORX®, Tamper-Resistant

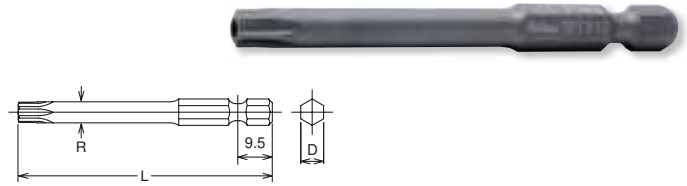

121T-50 / -70 (IP)

⚠ TORXPLUS® Bits
 TORXPLUS® Bits
 Embouts TORXPLUS®

TORXplus

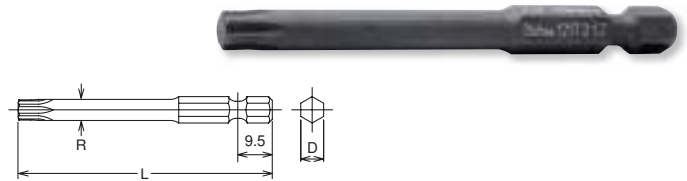

12137E 13137E 14137E

⚠ Impact Bit Holder
 Impact Klingenhalter
 Porte embouts Impact



12142-F6.3 13142-F6.3 14142-F6.3

⚠ Impact Bit Holder (Quick Release)
 Impact Klingenhalter (Quick Release)
 Porte embouts Impact (Quick Release)



123PT-75 / -100

⊕ Double ended Torsion Bits, PH
Doppelseitige Torsionsbits, PH
Embouts torsion double face, PH

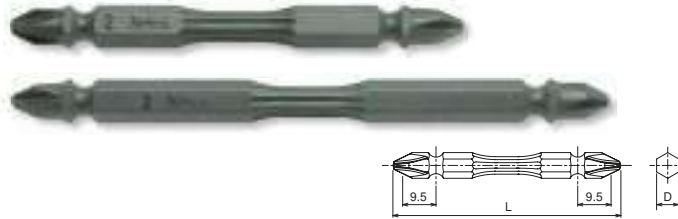

123PT (PH)	D (mm)	L (mm)	(g)	(pcs.)
2	6.35	75	18	10
2	6.35	100	24	10

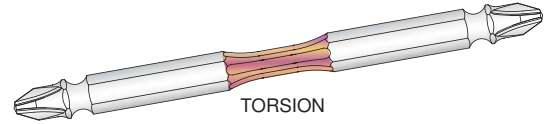

123PN-75 / -100

⊕ Double ended Bits, PH
Doppelseitige bits, PH
Embouts double face, PH

123PG-75 / -100

⊕ Magnetic type
Magnetsch
Type magnétique

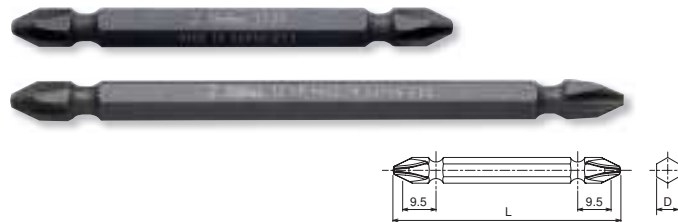

123PN.75 123PG.75 (PH)	D (mm)	L (mm)	(g)	(pcs.)
1	6.35	75	16	10
2	6.35	75	16	10
3	6.35	75	17	10

123PN.100 123PG.100 (PH)	D (mm)	L (mm)	(g)	(pcs.)
1	6.35	100	23	10
2	6.35	100	23	10
3	6.35	100	24	10

165LM

○ Slide Socket with Magnet
Gleitsteckschlüssel mit Magnet
Clé à douille coulissante avec aimant



Nut Setter

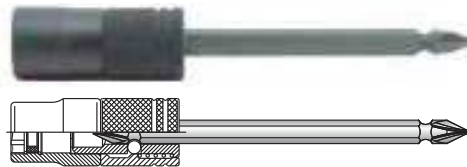

Phillips Bit

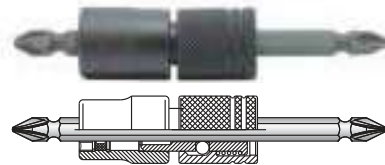

165LM.45 (mm)	D (mm)	H (mm)	L (mm)	(g)	(pcs.)
8	13.5	3.5	45	55	10
10	16	4.2	45	58	10
12	18.5	5.6	45	65	10
13	20	6	45	68	10
14	21	6.4	45	70	10

Slide the socket by pulling holder, and pull back the socket to lock on the bit groove. Ring magnet holds a bolt or nut for easy work.

Schieben Sie den Gleitsteckschlüssel durch Ziehen an der Hülse des Halters. Ziehen Sie das Werkzeug soweit zurück bis es sich in der Nut des Bits verriegelt. Zur Arbeitserleichterung hält der Ringmagnet die Schraube bzw. die Mutter.

Poussez la clé à douille coulissante en tirant sur le support. Tirez l'outil vers l'arrière jusqu'à ce qu'il s'enclenche dans la rainure de la meche. L'aimant maintient la vis ou l'écrou pour faciliter le travail.

⚠ You may not hold the sliding part while moving to avoid heating up by friction and reduction by wear.

Sie dürfen das Gleiteil nicht während der Bewegung halten, um Erwärmung durch Reibung und unnötigen Verschleiss zu vermeiden.

Ne pas tenir la partie coulissante pendant le mouvement pour éviter l'échauffement du au frottement et à l'usure inutile.

⚠ Please handle with care. The magnet could be broken with any impacts.

Der Magnet kann durch Stöße beschädigt werden. Bitte gehen Sie vorsichtig vor.

L'aimant peut être endommagé par des chocs importants. Veuillez procéder avec précaution.

165BM

○ Double-sided socket with side magnets
Doppelseitiger Schiebsteckschlüssel mit Seitenmagneten
Clé à douille double face, coulissante avec aimants latéraux

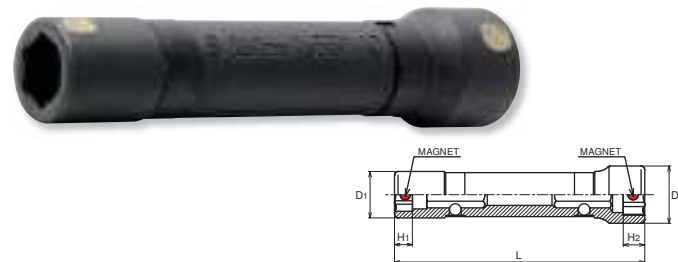

165BM.70 (mm)	D ₁ (mm)	D ₂ (mm)	H ₁ (mm)	H ₂ (mm)	L (mm)	(g)	(pcs.)
8×10	13	16	5	6	70	55	10

165BM.80 (mm)	D ₁ (mm)	D ₂ (mm)	H ₁ (mm)	H ₂ (mm)	L (mm)	(g)	(pcs.)
10×12	16	19.1	6	8	80	80	10
New 10×13	16	20.5	8	8	80	80	10

165BM.100 (mm)	D ₁ (mm)	D ₂ (mm)	H ₁ (mm)	H ₂ (mm)	L (mm)	(g)	(pcs.)
New 10×12	16	19.1	8	8	100	95	10
New 10×14	16	21.5	8	10	100	105	10
New 12×14	19.1	21.5	8	10	100	130	10

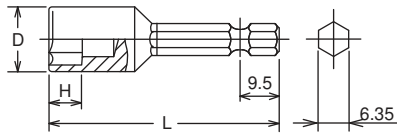

113-50 (mm)	D (mm)	H (mm)	L (mm)	(g)	(pcs.)
5.5	9	4	50	15	10
6	10	5	50	17	10
7	11	5	50	19	10
8	12	6	50	20	10
10	14.2	7	50	31	10
11	16	8	50	28	10
12	17	8	50	39	10
13	18	8	50	42	10
14	19	9	50	46	10

New

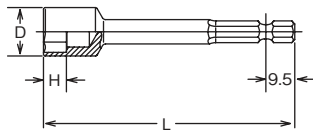

113-75 (mm)	D (mm)	H (mm)	L (mm)	(g)	(pcs.)
7	11.5	5	75	31	10
8	12.7	6	75	32	10
10	14.5	7	75	35	10
12	17	8	75	42	10
13	18	8	75	41	10
14	19	9	75	43	10

113-150 (mm)	D (mm)	H (mm)	L (mm)	(g)	(pcs.)
7	11.5	5	150	59	10
8	12.7	6	150	60	10
10	14.5	7	150	64	10
12	17	8	150	70	10
13	18	8	150	76	10
14	19	9	150	78	10

113-250 (mm)	D (mm)	H (mm)	L (mm)	(g)	(pcs.)
7	11.5	5	250	99	10
8	12.7	6	250	100	10
10	14.5	7	250	105	10
12	17	8	250	113	10
13	18	8	250	114	10
14	19	9	250	119	10

113-50 (E)	D (mm)	H (mm)	L (mm)	(g)	(pcs.)
E 4	6.1	4.5	50	12	10
E 5	7.5	4.5	50	15	10
E 6	8.3	5.0	50	17	10
E 7	8.8	5.8	50	18	10
E 8	10.1	6.6	50	19	10
E10	12	7.4	50	20	10

113-50 (mm)	D (mm)	H (mm)	L (mm)	(g)	(pcs.)
7(2B)	11	5	50	20	10
8(2B)	12	6	50	21	10
10(2B)	14.2	7	50	26	10
13(2B)	18	8	50	31	10

113-50 (inch)	D (mm)	H (mm)	L (mm)	(g)	(pcs.)
3/8(2B)	14.2	7	50	26	10



NUT GRIP®

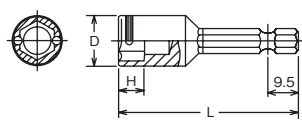

113-50

Nut Setters
Steckschlüssel Klingen
Embout pour écrous



113-50 (inch)	D (mm)	H (mm)	L (mm)	(g)	(pcs.)
1/4	10	5	50	17	10
5/16	12	6	50	20	10
3/8	14.2	7	50	31	10
1/2	18	8	50	42	10

113-75 / -100 / -150 / -200 / -250

Nut Setters
Steckschlüssel Klingen
Embout pour écrous



113-100 (mm)	D (mm)	H (mm)	L (mm)	(g)	(pcs.)
7	11.5	5	100	40	10
8	12.7	6	100	41	10
10	14.5	7	100	45	10
12	17	8	100	52	10
13	18	8	100	51	10
14	19	9	100	53	10

113-200 (mm)	D (mm)	H (mm)	L (mm)	(g)	(pcs.)
7	11.5	5	200	78	10
8	12.7	6	200	79	10
10	14.5	7	200	83	10
12	17	8	200	91	10
13	18	8	200	93	10
14	19	9	200	95	10

113-50 (E)

Nut Setters, TORX®
Steckschlüssel Klingen, TORX®
Embout pour écrous, TORX®

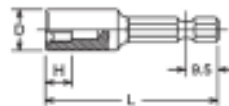

113-50 (2B)

Nut Setters, with 2 Balls
Steckschlüssel Klingen, mit 2-facher Kugelhalterung
Douilles à billes de retenue
Nut Grip®



Z-SERIES
HAND
TITANIUM
ACCESSORIES
SCREWDRIVERS
IMPACT
SLEEVE-DRIVE
PROTECTOR
INDUSTRIAL
AUTOMOTIVE
MOTORCYCLE
CONSTRUCTION
SPARE PART

115-50  Nut Setters with Magnet
Steckschlüssel Klingen mit Magnet
Embouts avec aimant pour écrous

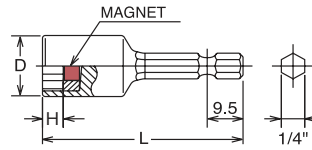

115-50 (mm)	D (mm)	H (mm)	L (mm)	(g)	(pcs.)
5.5	9	2.1	50	15	10
6	10	2.4	50	17	10
7	11	2.8	50	19	10
8	12	3.5	50	20	10
10	14.2	4.2	50	29	10
New 11	16	4.9	50	35	10
12	17	5.6	50	40	10
13	18	6	50	50	10
14	19	6.4	50	60	10

115-50 (inch)	D (mm)	H (mm)	L (mm)	(g)	(pcs.)
1/4	10	2.4	50	17	10
5/16	12	3.5	50	20	10
3/8	14.2	4.2	50	29	10
1/2	18	6	50	50	10

115-75 / -100 / -150 / -200 / -250

 Nut Setters with Magnet
Steckschlüssel Klingen mit Magnet
Embouts avec aimant pour écrous

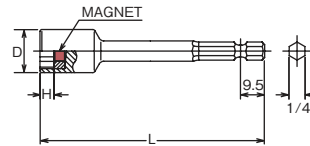

115-75 (mm)	D (mm)	H (mm)	L (mm)	(g)	(pcs.)
7	11.5	2.8	75	32	10
8	12.7	3.5	75	33	10
10	14.5	4.2	75	38	10
12	17	5.6	75	46	10
13	18	6	75	49	10
14	19	6.4	75	52	10

115-100 (mm)	D (mm)	H (mm)	L (mm)	(g)	(pcs.)
7	11.5	2.8	100	41	10
8	12.7	3.5	100	42	10
10	14.5	4.2	100	50	10
12	17	5.6	100	58	10
13	18	6	100	62	10
14	19	6.4	100	65	10

115-150 (mm)	D (mm)	H (mm)	L (mm)	(g)	(pcs.)
7	11.5	2.8	150	60	10
8	12.7	3.5	150	61	10
10	14.5	4.2	150	68	10
12	17	5.6	150	77	10
13	18	6	150	82	10
14	19	6.4	150	85	10

115-200 (mm)	D (mm)	H (mm)	L (mm)	(g)	(pcs.)
7	11.5	2.8	200	79	10
8	12.7	3.5	200	80	10
10	14.5	4.2	200	88	10
12	17	5.6	200	97	10
13	18	6	200	102	10
14	19	6.4	200	105	10

115-250 (mm)	D (mm)	H (mm)	L (mm)	(g)	(pcs.)
7	11.5	2.8	250	101	10
8	12.7	3.5	250	103	10
10	14.5	4.2	250	110	10
12	17	5.6	250	118	10
13	18	6	250	122	10
14	19	6.4	250	124	10



113UN-100 / -150 / -200

6-point Universal Joint Nut Setters
6-kant Steckschlüsselklingen mit Gelenk
Douilles 6-pans articulées à embout

113UN-100 (mm)	D (mm)	H (mm)	L (mm)	(g)	(pcs.)
8	13	7	100	50	10
10	15	8	100	53	10
12	17	10	100	56	10
13	18	10	100	65	10
14	19.2	10	100	67	10

113UN-150 (mm)	D (mm)	H (mm)	L (mm)	(g)	(pcs.)
8	13	7	150	65	10
10	15	8	150	70	10
12	17	10	150	77	10
13	18	10	150	92	10
14	19.2	10	150	92	10

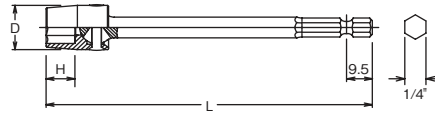

113UN-200 (mm)	D (mm)	H (mm)	L (mm)	(g)	(pcs.)
8	13	7	200	75	10
10	15	8	200	87	10
12	17	10	200	98	10
13	18	10	200	116	10
14	19.2	10	200	116	10

115G-75 / -100 / -150 / -200 / -250

Nut Setters with sliding Magnet
Steckschlüssel Klingen mit versenkbarem Magnet
Embouts avec aimant, glissant pour écrous

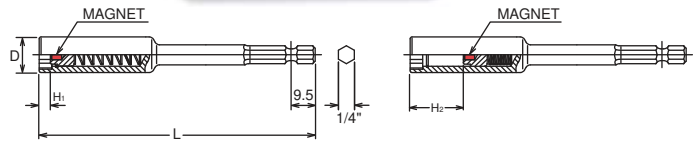

115G-75 (mm)	D (mm)	H ₁ (mm)	H ₂ (mm)	L (mm)	(g)	(pcs.)
7	11.5	3.5	26	75	34	10
8	12.7	4	26	75	41	10
10	14.5	4.5	26	75	48	10
12	17	6	26	75	65	10
13	18	6.5	25	75	70	10
14	19	7	24	75	73	10

115G-150 (mm)	D (mm)	H ₁ (mm)	H ₂ (mm)	L (mm)	(g)	(pcs.)
7	11.5	3.5	26	150	67	10
8	12.7	4	26	150	70	10
10	14.5	4.5	26	150	77	10
12	17	6	26	150	95	10
13	18	6.5	25	150	100	10
14	19	7	24	150	105	10

115G-250 (mm)	D (mm)	H ₁ (mm)	H ₂ (mm)	L (mm)	(g)	(pcs.)
8	12.7	4	26	250	110	10
10	14.5	4.5	26	250	120	10
12	17	6	26	250	130	10
13	18	6.5	25	250	150	10

115G-100 (mm)	D (mm)	H ₁ (mm)	H ₂ (mm)	L (mm)	(g)	(pcs.)
7	11.5	3.5	26	100	51	10
8	12.7	4	26	100	51	10
10	14.5	4.5	26	100	57	10
12	17	6	26	100	77	10
13	18	6.5	25	100	80	10
14	19	7	24	100	82	10

115G-200 (mm)	D (mm)	H ₁ (mm)	H ₂ (mm)	L (mm)	(g)	(pcs.)
7	11.5	3.5	26	200	86	10
8	12.7	4	26	200	89	10
10	14.5	4.5	26	200	96	10
12	17	6	26	200	119	10
13	18	6.5	25	200	125	10
14	19	7	24	200	128	10

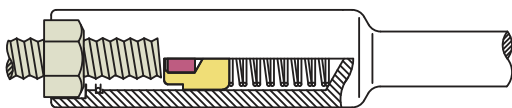

Sliding magnet system provides bolt clearance and magnetic function at the same time. The item 115G is mainly designed for assembly line work.

Die Steckschlüsselklinge mit versenkbarem Magnet bietet die Funktion eines Haltemagneten und genügend Freiraum für überstehende Bolzen. Dieses Werkzeug eignet sich vor allem für Montagearbeiten.

L'embout avec aimant glissant offre une fonction d'aimant et laisse assez d'espace pour des goujons surmontés. L'objet 115G a été conçu spécialement pour le travail d'assemblage.

119 (mm)	D (mm)	H (mm)	L (mm)	(g)	(pcs.)
5.5	9	2.1	50	17	10
6	10	2.4	50	20	10
7	11	2.8	50	22	10
8	12	3.5	50	23	10
10	14.2	4.2	50	30	10
12	17	5.6	50	42	10
13	18	6	50	52	10

119 (inch)	D (mm)	H (mm)	L (mm)	(g)	(pcs.)
1/4	10	1.8	50	20	10
5/16	12	3.5	50	23	10
3/8	14.2	4.2	50	30	10

119

Nut Setters with Magnet
Steckschlüssel Klingen mit Magnet
Embouts avec aimant pour écrous

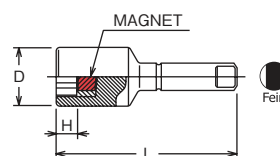

Z-SERIES
HAND
TITANIUM
ACCESSORIES
SCREWDRIVERS
IMPACT
SLEEVE-DRIVE
PROTECTOR
INDUSTRIAL
AUTOMOTIVE
MOTORCYCLE
CONSTRUCTION
SPARE PART

183H-35 / -75 / -150

Hex Bits
Sechskant Bits
Embout, 6 pans creux

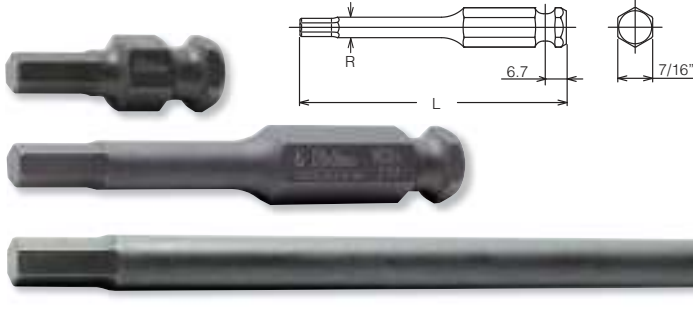

183H-35 (inch)	L (mm)	(g)	(pcs.)
3/16	35	15	10
7/32	35	16	10
1/4	35	18	10
5/16	35	20	10
3/8	35	26	10
7/16	35	28	10
1/2	35	38	10

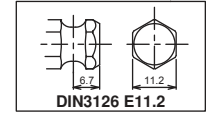

183H-35 (mm)	L (mm)	(g)	(pcs.)
3	35	15	10
4	35	15	10
5	35	15	10
6	35	18	10
7	35	19	10
8	35	20	10
9	35	23	10
10	35	26	10
11	35	28	10
12	35	30	10
14	35	35	10
16	35	47	10
17	35	50	10
18	35	53	10
19	35	56	10

183H-75 (mm)	L (mm)	R (mm)	(g)	(pcs.)
3	75	6	34	10
4	75	6	35	10
5	75	6.5	36	10
6	75	7.5	39	10
7	75	8.5	44	10
8	75	9.5	47	10
10	75	-	57	10
11	75	-	60	10
12	75	-	65	10
14	75	-	79	10

183H-150 (mm)	L (mm)	R (mm)	(g)	(pcs.)
4	150	6	51	10
5	150	6.5	55	10
6	150	7.5	65	10
8	150	9.5	87	10
10	150	-	118	10
12	150	-	136	10

183T-35 / -75 / -150 (T)

TORX® Bits
TORX® Bits
Embout, TORX®

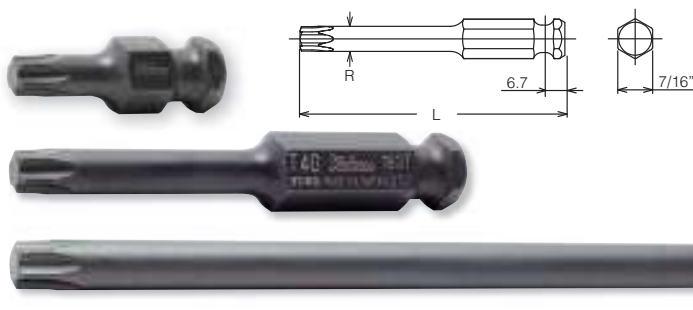

183T-35 (T)	L (mm)	(g)	(pcs.)
T25	35	18	10
T30	35	18	10
T40	35	20	10
T45	35	22	10
T50	35	26	10
T55	35	30	10
T60	35	38	10

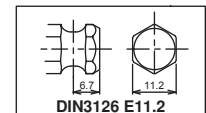

183T-75 (T)	L (mm)	R (mm)	(g)	(pcs.)
T30	75	6	35	10
T40	75	6.9	37	10
T45	75	8	41	10
T50	75	9	45	10
T55	75	11.4	55	10
T60	75	13.5	67	10

183T-150 (T)	L (mm)	R (mm)	(g)	(pcs.)
T30	150	6	50	10
T40	150	6.9	58	10
T45	150	8	70	10
T50	150	9	82	10
T55	150	11.4	113	10

183T-35 / -75 (IP)

TORXPLUS® Bits
TORXPLUS® Bits
Embout TORXPLUS®

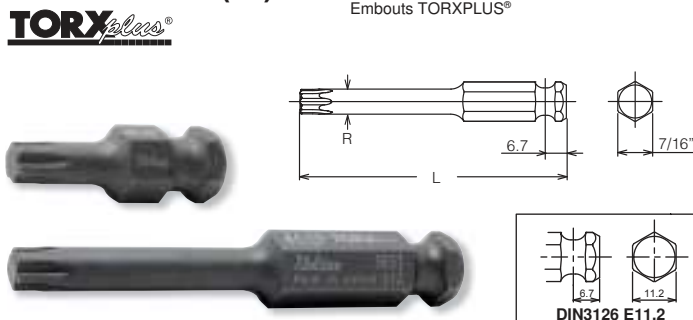

183T-35 (IP)	L (mm)	(g)	(pcs.)
30IP	35	18	10
40IP	35	20	10
45IP	35	22	10
50IP	35	26	10
55IP	35	30	10
60IP	35	38	10

183T-75 (IP)	L (mm)	R (mm)	(g)	(pcs.)
30IP	75	6	35	10
40IP	75	6.8	37	10
45IP	75	8	41	10
50IP	75	9	45	10
55IP	75	11.4	56	10
60IP	75	13.5	67	10

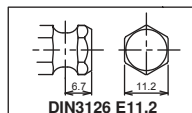

The items with ⚠ have larger output size than 7/16" input hex drive. Due to this design the Maximum output torque rating is less than standards.

183X-35 (XZN)	L (mm)	(g)	(pcs.)
M 4	35	18	10
M 5	35	18	10
M 6	35	20	10
M 8	35	22	10
M10	35	26	10
M12	35	30	10
M14	35	38	10

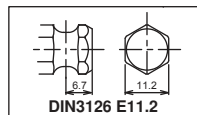

183X-35 / -75 / -150 (XZN)

XZN Bits
XZN Bits
Embouts, XZN

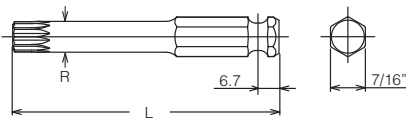

183X-75 (XZN)	L (mm)	R (mm)	(g)	(pcs.)
M 4	75	6	34	10
M 5	75	6	34	10
M 6	75	6.2	36	10
M 8	75	7.4	39	10
M10	75	9.8	54	10
M12	75	11.7	57	10
M14	75	13.5	67	10

183X-150 (XZN)	L (mm)	R (mm)	(g)	(pcs.)
M 5	150	6	50	10
M 6	150	6.2	53	10
M 8	150	7.4	64	10
M10	150	9.8	93	10
M12	150	11.7	121	10

⚠ The items with ⚠ have larger output size than 7/16" input hex drive.
Due to this design the Maximum output torque rating is less than standards.

	□	D ₁ (mm)	D ₂ (mm)	L (mm)	(g)	(pcs.)	⚡
13134	3/8"	22.5	22	32	70	10	*1
14134	1/2"	22.5	25	38	90	10	*2
16134	3/4"	24	44	52	200	2	*3

*1 C-Ring=C32,Pin/O-Ring=A32/B32

*2 C-Ring=C41,Pin/O-Ring=A41/B41 → P256-257

*3 C-Ring=C61,Pin/O-Ring=A61/B61

For DIN3126 E11.2 Bits
Für DIN3126 E11.2 Bits
Pour DIN3126 E11.2 Embouts

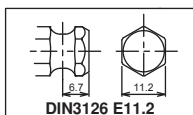

13134-SC

Replacement Screw : M8x5, ● 4mm
Ersatzschraube : M8x5, ● 4mm
Vis de remplacement : M8x5, ● 4mm

16134-SC

Replacement Screw : M8x6, ● 4mm
Ersatzschraube : M8x6, ● 4mm
Vis de remplacement : M8x6, ● 4mm

13134 14134 16134

○ Impact Bit Holder
Impact Klingenhalter
Porte embouts Impact

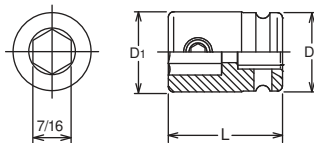

	□	D ₁ (mm)	D ₂ (mm)	L (mm)	(g)	(pcs.)	⚡
13142-F11.2	3/8"	18.9	22	46	116	10	*1
14142-F11.2	1/2"	18.9	25	46	207	10	*2

*1 C-Ring=C32,Pin/O-Ring=A32/B32

*2 C-Ring=C41,Pin/O-Ring=A41/B41 → P256-257

For DIN3126 E11.2 Bits
Für DIN3126 E11.2 Bits
Pour DIN3126 E11.2 Embouts

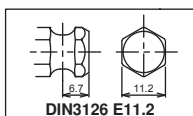

13142-F11.2 14142-F11.2

○ Impact Bit Holder (Quick Release)
Impact Klingenhalter (Quick Release)
Porte embouts Impact (Quick Release)

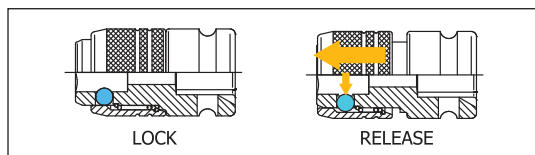
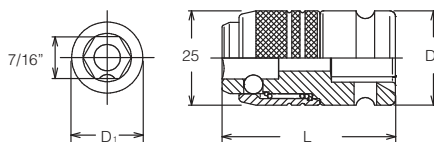

Adaptors with male Square
Verbindungssteile mit Aussenvierkant
Adaptateurs avec carré mâle

Z-SERIES

HAND

TITANIUM

ACCESSORIES

SCREWDRIVERS

IMPACT

SLEEVE-DRIVE

PROTECTOR

INDUSTRIAL

AUTOMOTIVE

MOTORCYCLE

CONSTRUCTION

SPARE PART

**110-35B / -50B / -100B / -150B
-35P / -50P / -100P / -150P**

Adaptors
Verbindungsstücke
Adaptateurs



110		TYPE	L (mm)	(g)	(pcs.)
35B	1/4"	Ball	35	9	10
35P		Pin	35	9	10
50B		Ball	50	15	10
50P		Pin	50	15	10
100B		Ball	100	34	10
100P		Pin	100	34	10
150B	Ball	150	54	10	
150P	Pin	150	54	10	

● DIN 3126 Form E 6.3

**112-50B / -100B / -150B
-50P / -100P / -150P**

Adaptors
Verbindungsstücke
Adaptateurs



112		TYPE	L (mm)	(g)	(pcs.)
50B	3/8"	Ball	50	22	10
50P		Pin	50	22	10
100B		Ball	100	71	10
100P		Pin	100	71	10
150B		Ball	150	121	10
150P		Pin	150	121	10

● DIN 3126 Form E 6.3

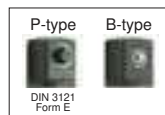

135E-60B / -60P

Adaptor
Verbindungsstück
Adaptateurs

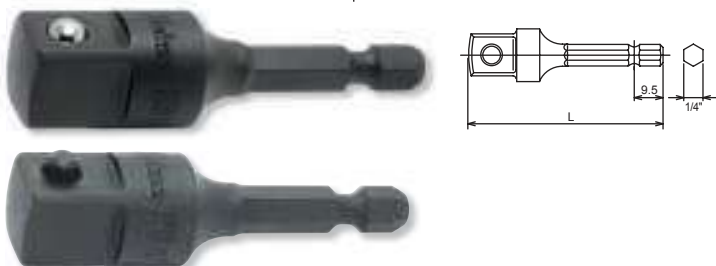

135E		TYPE	L (mm)	(g)	(pcs.)
60B	1/2"	Ball	60	46	10
60P		Pin	60	46	10

● DIN 3126 Form E 6.3

**117-50B / -100B
-50P / -100P**

Adaptors
Verbindungsstücke
Adaptateurs



117		TYPE	L (mm)	(g)	(pcs.)
50B	1/4"	Ball	50	15	10
50P		Pin	50	15	10
100B		Ball	100	71	10
100P		Pin	100	71	10

● DIN 3126 Form G7

120-50B / -50P

Adaptor
Verbindungsstück
Adaptateurs



120		TYPE	L (mm)	(g)	(pcs.)
50B	3/8"	Ball	50	27	10
50P		Pin	50	27	10

● DIN 3126 Form E 8

186-75P

Adaptor
Verbindungsstück
Adaptateurs

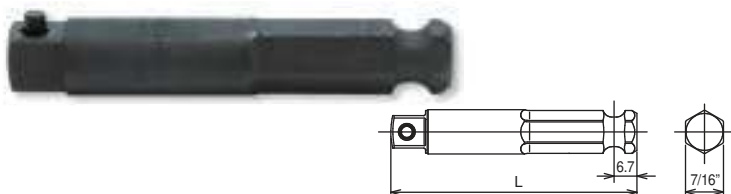

186		L (mm)	(g)	(pcs.)
75P	3/8"	75	65	10
75P	1/2"	75	85	10

● DIN 3126 Form E 11.2

**SCREWDRIVERS
SCHRAUBENDREHER
TOURNEVIS**



Z-SERIES
HAND
TITANIUM
ACCESSORIES
SCREWDRIVERS
IMPACT
SLEEVE-DRIVE
PROTECTOR
INDUSTRIAL
AUTOMOTIVE
MOTORCYCLE
CONSTRUCTION
SPARE PART

167M / 167A



Socket Drivers
Sechskant Steckschlüssel, mit Griff
Clé à douille avec manche

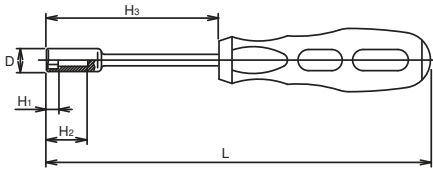

167M (mm)	D (mm)	H ₁ (mm)	H ₂ (mm)	H ₃ (mm)	L (mm)	(g)	(pcs.)
3	5.8	3	25	125	225	62	6
3.5	5.8	3	25	125	225	62	6
4	6.7	3.5	25	125	225	64	6
4.5	7.2	4.5	25	125	225	65	6
5	7.8	5	25	125	225	66	6
5.5	8.4	5.5	25	125	225	68	6
6	9.1	6	25	125	225	70	6
7	10.9	6.5	25	125	235	101	6
8	12	7	25	125	235	103	6
9	13.2	7.5	25	125	235	107	6
10	14.5	8	25	125	235	111	6
11	15.9	8.5	25	125	245	155	6
12	16.8	9	25	125	245	161	6
13	18.2	9.5	25	125	245	167	6
14	19.2	11	25	125	245	178	6

167A (inch)	D (mm)	H ₁ (mm)	H ₂ (mm)	H ₃ (mm)	L (mm)	(g)	(pcs.)
1/4	9.1	6	25	125	225	70	6

167C (2B)



Interchangeable Socket Driver, **Nut Grip**[®]
Universalgriff mit auswechselbaren **Nut Grip**[®] Steckschlüsselklingen
Clé à douille interchangeable avec manche **Nut Grip**[®]

167C/3-2B



Set 3 pieces
Satz 3teilig
Jeu de 3 tournevis

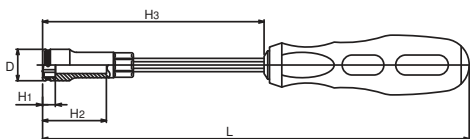

167C(2B) (mm)	D (mm)	H ₁ (mm)	H ₂ (mm)	H ₃ (mm)	L (mm)	(g)	(pcs.)
7(2B)	11.5	4	38	122	235	120	6
8(2B)	12.3	5	38	122	235	125	6
10(2B)	14.2	6	38	122	235	130	6
12(2B)	17.3	7	38	122	235	135	6

167C/3-2B	4 Pieces Set/△=280g
PLASTIC BAG	
Socket Drivers	
Socket:	7, 8, 10
Grip:	167C-GRIP

168H-B



Ball Point Hex Screwdrivers
Schraubendreher Innensechskant mit Kugelkopf
Tournevis avec tête sphérique pour vis 6-pans creux

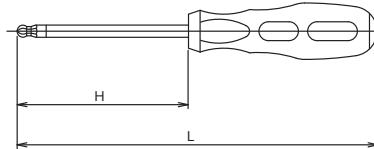

168H (mm)	H (mm)	L (mm)	(g)	(pcs.)
3B	80	150	25	6
4B	125	225	60	6
5B	125	235	85	6
6B	125	245	150	6
7B	125	245	151	6
8B	125	245	153	6

Ball point Hex Screwdrivers have less strength due to the special design. Make sure to use them correctly.

168T (TH)



Screwdriver for TORX® Tamper Resistant
TORX® Schraubendreher Tamper-Resistant
Tournevis pour vis TORX® tamper resistant

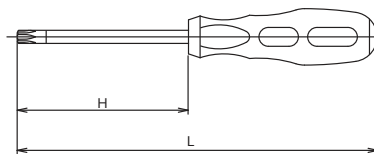

168T (TH)	H (mm)	L (mm)	(g)	(pcs.)
T10H	80	150	25	6
T15H	80	150	25	6
T20H	125	225	60	6
T25H	125	225	60	6
T27H	125	235	90	6
T30H	125	235	92	6
T40H	125	245	153	6

Tamper Resistant TORX® Screwdrivers have less strength due to the special design. Make sure to use it correctly.

168T/7-TH	(g)
168T-T10H, T15H, T20H, T25H, T27H, T30H, T40H	480



168T/7 (TH)



Set 6 pieces
Satz 6teilig
Jeu de 6 tournevis



168P (PZ)



Pozidriv Screwdrivers
Schraubendreher, Pozidriv
Tournevis pour vis Pozidriv

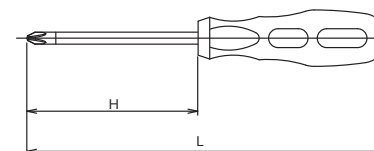

168P (PZ)	H (mm)	L (mm)	(g)	(pcs.)
PZ1	75	175	78	6
PZ2	100	210	129	6
PZ3	150	270	203	6

Screwdrivers Schraubendreher Tournevis

Z-SERIES
HAND
TITANIUM
ACCESSORIES
SCREWDRIVERS
IMPACT
SLEEVE-DRIVE
PROTECTOR
INDUSTRIAL
AUTOMOTIVE
MOTORCYCLE
CONSTRUCTION
SPARE PART

166P  Screwdriver PH (Blade-Through type)
Kreuzschlitz Schraubendreher PH mit durchgehender 6-kant Klinge
Tournevis pour vis cruciformes PH

166S  Slotted screwdriver (Blade-Through type)
Schlitz-Schraubendreher mit durchgehender 6-kant Klinge
Tournevis pour vis à fente

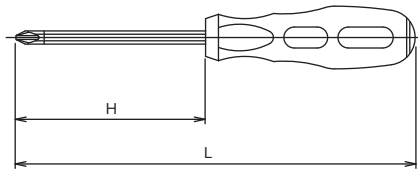



166P (PH)	H (mm)	L (mm)	(g)	(pcs.)
1	75	175	78	6
2	100	210	129	6
3	150	270	203	6

166S	H (mm)	L (mm)	(g)	(pcs.)
5	75	175	78	6
6	100	210	129	6
8	150	270	203	6



166PS/6   Set 6 pieces
Satz 6teilig
Jeu de 6 tournevis



166PS/6	6 Pieces Set/△=885g
CARDBOARD BOX:W280xH115xT40mm	
Screwdrivers	
	166P Screwdrivers 1, 2, 3
	166S Screwdrivers 5, 6, 8

PK166PS/6   Set 6 pieces in Plastic Box
Satz 6teilig in Plastikkassette
Module plastique des 6 tournevis



PK166PS/6	6 Pieces Set/△=950g
PLASTIC TRAY	
Screwdrivers	
	166P Screwdrivers 1, 2, 3
	166S Screwdrivers 5, 6, 8

168P  Screwdriver (Blade-Through Type), PH
Schraubendreher mit durchgehender Klinge, PH
Tournevis à zone de frappe, PH

168S  Slotted Screwdriver
Schlitz-Schraubendreher
Tournevis pour vis à fente

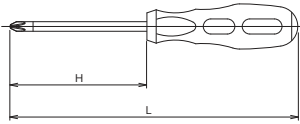

168P (PH)	H (mm)	L (mm)	(g)	(pcs.)
1	75	175	59	6
2	100	210	86	6
2(150)	150	260	100	6
2(200)	200	310	111	6
2(300)	300	410	133	6
3	150	270	150	6

168S	H (mm)	L (mm)	(g)	(pcs.)
5	75	175	59	6
6	100	210	86	6
6(150)	150	260	100	6
6(200)	200	310	111	6
6(300)	300	410	133	6
8	150	270	150	6

168PS/6 6 Pieces Set/△=660g

CARDBOARD BOX:W280×H115×T40mm

Screwdrivers

 168P Screwdrivers
1, 2, 3

 168S Screwdrivers
5, 6, 8

PK168PS/6 6 Pieces Set/△=720g

PLASTIC TRAY

Screwdrivers

 168P Screwdrivers
1, 2, 3

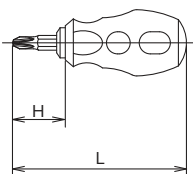

 168S Screwdrivers
5, 6, 8



168CS	H (mm)	L (mm)	(g)	(pcs.)
2×6	22	86	46	6

168CS   Interchangeable Screwdriver, Stubby
Schraubendrehergriff für auswechselbare Klinge, kurz
Poignée porte-lames reversible, court



168C   Interchangeable Screwdriver
Schraubendrehergriff für auswechselbare Klingen
Poignée porte-lames reversible

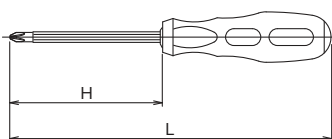

168C	H (mm)	L (mm)	(g)	(pcs.)
2×6	100	210	108	6
2×6(150)	150	260	120	6
2×6(200)	200	310	133	6



Z-SERIES
HAND
TITANIUM
ACCESSORIES
SCREWDRIVERS
IMPACT
SLEEVE-DRIVE
PROTECTOR
INDUSTRIAL
AUTOMOTIVE
MOTORCYCLE
CONSTRUCTION
SPARE PART

2769N-150 / -220

Spin Type Handle
Drehgriff
Poignée emmanchée

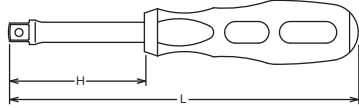

2769N		H (mm)	L (mm)	(g)	(pcs.)
150	1/4"	50	150	73	2
220		120	220	100	2



Plastic or rubber handles are not intended to act as insulation.

Plastik- oder Gummigriffe stellen keinen Isolierschutz dar.

Les poignées en plastique ou en caoutchouc ne garantissent aucune isolation électrique.

2769NWF-150 / -220

Spin Type Handle (Wobble-Fix)
Drehgriff, Wobble-Fix
Poignée emmanchée, angulaire

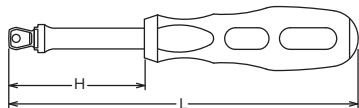

2769NWF		H (mm)	L (mm)	(g)	(pcs.)
150	1/4"	50	150	73	2
220		120	220	100	2

Wobble-Fix Extension Bar

Two way usage

- a) In a fixed position, as a normal extension bar
- b) In a half-fixed position, as a flexible extension bar providing a 15° angle operation

Winkel-Verlängerungen

Winkelverlängerungen lassen sich in zwei Einstellungen verwenden

- a) voll eingesteckt und starr,
- b) halb eingesteckt, mit einem Arbeitswinkel von 15°.

Rallonges angulaires

Deux utilisations possibles

- a) comme rallonge normale, dans une position fixe
- b) comme une rallonge angulaire avec une possibilité d'inclinaison jusqu'à 15°

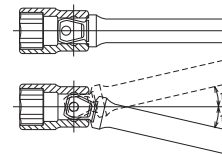

3769N-160 / -230

Spin Type Handle
Drehgriff
Poignée emmanchée

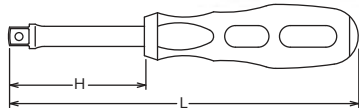

3769N		H (mm)	L (mm)	(g)	(pcs.)
160	3/8"	50	160	110	2
230		120	230	135	2

3769NWF-160 / -230

Spin Type Handle (Wobble-Fix)
Drehgriff, Wobble-Fix
Poignée emmanchée, angulaire

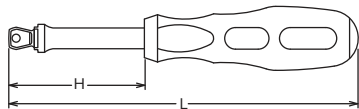

3769NWF		H (mm)	L (mm)	(g)	(pcs.)
160	3/8"	50	160	110	2
230		120	230	135	2

IMPACT

SOCKETS
STECKSCHLÜSSEL
DOUILLES

1/4"

3/8"

1/2"

5/8"

3/4"

1"

1-1/2"

2-1/2"

















































3-1/2"



































































Impact Sockets

Impact Steckschlüssel

Douilles Impact

Impact Sockets	1/4"(6.35mm)SQ.				3/8"(9.5mm)SQ.				Square Drive				5/8"(15.9mm)SQ.		3/4"(19mm)SQ.		
	No.	Page	No.	Page	No.	Page	No.	Page	No.	Page	No.	Page	No.	Page	No.	Page	
Standard Sockets	 6-point	12400M 12400A	778	13400M 13400A	782	14400M 14400A	199	15400M	219	16400M 16400A	221	16405M 16405A	221	16401M 16401A	222	16405M 16405A	221
	 6-point (with Magnet)	12400MG 12400AG	778	13400MG 13400AG	782	14400MG 14400A	200			16401M 16401A	222						
	 12-point			13405M 13405A	782	14405M 14405A	199										
	 12-point (Thin-walled)			13406A	783	14406M 14406A	200										
	 Surface	12410M	778	13410M	784	14410M	201	15410M	219	16410M	222						
	 PATHFINDER®	12465M	779	13465M	784	14465M	202										
	 TORX®	12425	TORX® 779	13425	TORX® 784	14425	TORX® 202			16425	TORX® 223						
	 TORXplus® (E)			13425EG	TORXplus® 784	14425	TORXplus® 202										
	 TORXplus® (EP)			13425-EPL	TORXplus® 784	14425-EPL	TORXplus® 202			16425-EPL	TORXplus® 223						
	 LH-S			13401LH	LH-STIX® 785	14401LH	LH-STIX® 201										
 for Self Tapping Screws	12460M 12460A	779	13460M 13460A	785	14460M 14460A	203											
 for Self Tapping Screws (with Magnet)	12460MG 12460AG	779	13460MG 13460AG	785	14460M 14460A	204											
 Double Square					14415M	202											
 for Weld Nut			13400-WN	785	14400-WN	202											
 Short Sockets	 6-point (Thin-walled)		13401MS	783	14401MS	201											
 6-point (Thin-walled)			13901X	786	14301X	203			16301X	224							
 Semi Deep Sockets	 6-point (with Slit Magnet)		13300XG	786													
 6-point	12300M	780	13300M 13300A	786	14300M 14300A	203	15300M	219	16300M 16300A	224							
 6-point (Thin-walled)			13301M 13301A	787	14301M 14301A	204			16301M 16301A	225							
 6-point (with Slit Magnet)	12300G	780	13300G	788	14300G	205											
 12-point			13305M	787	14305M	204			16305M	225							
 12-point (Thin-walled)			13306M	787	14306M	204											
 Surface			13310M	788	14310M	205	15310M	219	16310M	226							
 PATHFENDER®	12365M	780	13365M	788	14365M	205											
 TORX® (E)			13325	TORX® 788	14325	TORX® 205			16325	TORX® 226							
 6-point			13145M	790	14145M	207											
 6-point (with Magnet)			13145MG	790													
 12-point			13145M(12P)	790													
 6-point			13440M 13440A	789	14440M 14440A	206											
 6-point (Extension)			13146M	791	14146M	208											
 Universal Sockets	 TORX® (E)		13440T	TORX® 789													
 6-point			13012M	792	14012M	209											
 6-point			13025	TORX® 792	14025	TORX® 209											
 Hexagon Bit Sockets	 Hexagon (T)		13134M	795	14134M	212											
 Hexagon			13134TT	TORX® 795	14134TT	TORX® 212											
 TORXplus® (T)			13134T(TIP)	TORXplus® 795	14134T(TIP)	TORXplus® 212											
 TORXplus® (EP)			13134X(XZN)	XZN 795	14134X(XZN)	XZN 212											
 XZN (Triple Square)			13430M	789													
 Hexagon			13147M	791	14147M	208											
 Hexagon (Extension)																	
 Extension Bars	12760	781	13760	797	14760	215			16760	229							
 Universal Joints	12770	781	13770 13771 13772	798	14770 14771 14772	216	15770	220	16770 16771	230							
 Adaptors	12233A	781	13322A 13344A	798	14433A 14455A 14466A	216	15544A 15566A	220	16644A 16655A 16688A	230							
 Locking Adaptors	12222AL	781	13333AL	797	14444AL 14466AL	215	15555AL	220	16666AL 16644AL	230							

Impact Sockets
Impact Steckschlüssel
Douilles Impact

Impact Sockets	1"(25.4mm)SQ.			1.1/2"(38.1mm)SQ.			2.1/2"(63.5mm)SQ.			3.1/2"(88.9mm)SQ.		
	No.	mm inch	Page	No.	mm inch	Page	No.	mm inch	Page	No.	mm inch	Page
 <p>Standard Sockets</p>	 6-point	18400M	232	17400M	242	242	19400M	246	246	10400M	248	248
	 6-point (Thin-walled)	18400A	232	17400A	242	242	19400A	246	246	10400A	248	248
	 6-point (with Magnet)	18401M	233									
	 12-point	18401A	233									
	 12-point (Thin-walled)	18405M	233-234	17405M	243	243						
	 Surface	18405A	233	17405A	243	243						
	 PATHFINDER®	18410M	234									
	 TORX®											
	 TORX® (E)											
	 TORX® (E) (with Magnet)											
 TORXplus®												
 LH-S												
 for Self Tapping Screws												
 for Self Tapping Screws (with Magnet)												
 Double Square												
 for Weld Nut												
 <p>Short Sockets</p>	 6-point (Thin-walled)											
	 6-point (Thin-walled)	18301X	235									
 <p>Semi Deep Sockets</p>	 6-point (with Slide Magnet)											
	 6-point	18300M	235	17300M	243	243	19300M	247	247			
 <p>Deep Sockets</p>	 6-point (Thin-walled)	18300A	235	17300A	243	243						
	 6-point (Thin-walled)	18301M	236									
	 6-point (with Slide Magnet)	18301A	236									
	 12-point											
	 12-point (Thin-walled)											
	 Surface	18310M	236									
 <p>Extension Sockets</p>	 PATHFINDER®											
	 TORX® (E)											
	 6-point	18104M	236									
	 6-point (with Magnet)											
 <p>Universal Sockets</p>	 12-point											
	 6-point (Extension)											
 TORX® (E)												
 <p>Bit Sockets</p>	 Hexagon											
	 TORX® (T)											
	 Hexagon	18106-16	237									
	 Hexagon	18107-22	239									
	 Hexagon	18108-32	240	17108-32	244	244						
 <p>Bit Sockets (Bit changeable)</p>	 TORX® (T)											
	 TORXplus® (IP)	18106-16(T)	237									
 XZN (Triple Square)	18106-16(XZN)	XZN	237									
 <p>Universal bit Sockets</p>	 Hexagon											
	 Hexagon (Extension)											
 <p>Extension Bars</p>	 Hexagon	18760	240	17760	245	245	19760	247	247			
	 Hexagon (Extension)	18770	241	17770	245	245	19770	247	247			
 <p>Universal Joints</p>	 Hexagon	18770	241	17770	245	245	19770	247	247			
	 Hexagon (Extension)	18771	241	17771	245	245	19771	247	247			
 <p>Adaptors</p>	 Hexagon	18866A	241	17866A	245	245	19866A	247	247			
	 Hexagon (Extension)	18877A	241	17877A	245	245	19877A	247	247	10089A	248	
 <p>Locking Adaptors</p>	 Hexagon	18888AL	241									
	 Hexagon (Extension)											

Impact Sockets Impact Steckschlüssel Douilles Impact

1/4"

Z-SERIES

HAND

TITANIUM

SCREWDRIVERS ACCESSORIES

IMPACT

SLEEVE-DRIVE

PROTECTOR

INDUSTRIAL

AUTOMOTIVE

MOTORCYCLE

CONSTRUCTION

SPARE PART

12400M / 12400A

6-point Sockets
6-kant Steckschlüssel
Douilles 6-pans

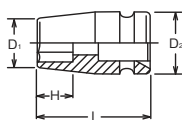

12400A (inch)	D ₁ (mm)	D ₂ (mm)	H (mm)	L (mm)	(g)	(pcs.)	
5/32	7.5	13	4	23	14	10	*1
3/16	8.1	13	4	23	14	10	*1
7/32	9.4	13	4	23	16	10	*1
1/4	10	13	5	23	14	10	*1
9/32	11.3	13	5	23	14	10	*1
5/16	12.5	13	6	23	14	10	*1
11/32	13.8	13	7	23	14	10	*1
3/8	15	13	7	23	15	10	*1
7/16	16.3	13	8	23	18	10	*1
1/2	18.8	13	8	23	19	10	*1
9/16	20	13	9	23	20	10	*1

*1 Pin/O-Ring=A21/B21 → P257

12400M (mm)	D ₁ (mm)	D ₂ (mm)	H (mm)	L (mm)	(g)	(pcs.)	
4	7.5	13	4	23	14	10	*1
4.5	8.1	13	4	23	14	10	*1
5	8.8	13	4	23	14	10	*1
5.5	9.4	13	4	23	14	10	*1
6	10	13	5	23	14	10	*1
7	11.3	13	5	23	14	10	*1
8	12.5	13	6	23	14	10	*1
9	13.8	13	7	23	14	10	*1
10	15	13	7	23	15	10	*1
11	16.3	13	8	23	18	10	*1
12	17.5	13	8	23	19	10	*1
13	18.8	13	8	23	19	10	*1
14	20	13	9	23	20	10	*1

*1 Pin/O-Ring=A21/B21 → P257

12400MG / 12400AG

6-point Sockets with Magnet
6-kant Steckschlüssel mit Magnet
Douilles 6-pans avec aimant

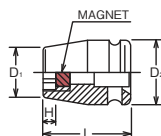

12400AG (inch)	D ₁ (mm)	D ₂ (mm)	H (mm)	L (mm)	(g)	(pcs.)	
3/16	8.1	13	2.1	23	13	10	*1
1/4	10	13	2.4	23	16	10	*1
5/16	12.5	13	3.5	23	17	10	*1
11/32	13.8	13	3.8	23	18	10	*1
3/8	15	13	4.2	23	18	10	*1
7/16	16.3	13	4.9	23	21	10	*1
1/2	18.8	13	6	25	21	10	*1
9/16	20	13	6.4	25	20	10	*1

*1 Pin/O-Ring=A21/B21 → P257

12400MG (mm)	D ₁ (mm)	D ₂ (mm)	H (mm)	L (mm)	(g)	(pcs.)	
4	7.5	13	2.1	23	12	10	*1
4.5	8.1	13	2.1	23	13	10	*1
5	8.8	13	2.1	23	15	10	*1
5.5	9.4	13	2.1	23	15	10	*1
6	10	13	2.4	23	16	10	*1
7	11.3	13	2.8	23	16	10	*1
8	12.5	13	3.5	23	17	10	*1
9	13.8	13	3.8	23	18	10	*1
10	15	13	4.2	23	18	10	*1
11	16.3	13	4.9	23	21	10	*1
12	17.5	13	5.6	25	21	10	*1
13	18.8	13	6	25	21	10	*1
14	20	13	6.4	25	20	10	*1

*1 Pin/O-Ring=A21/B21 → P257

12410M

Surface Drive Sockets
Surface Drive Steckschlüssel
Douilles, Surface Drive

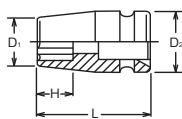

12410M (mm)	D ₁ (mm)	D ₂ (mm)	H (mm)	L (mm)	(g)	(pcs.)	
6	10	13	5	23	14	10	*1
7	11.3	13	5	23	15	10	*1
8	12.5	13	6	23	15	10	*1
9	13.8	13	7	23	14	10	*1
10	15	13	7	23	14	10	*1
11	16.3	13	8	23	17	10	*1
12	17.5	13	8	23	19	10	*1
13	18.8	13	8	23	19	10	*1

*1 Pin/O-Ring=A21/B21 → P257

SURFACE DRIVE

Surface drive sockets are designed to retain contact with the flat sides of the nut in order to transmit higher torque and reduce nut wear. These sockets are ideal for using on polished nuts, aluminum nuts and nuts with worn out points.

Das Profil unserer Surface-Drive Steckschlüssel greift die Schraube an deren Flächen. Dies sichert eine höhere Kraftübertragung und verhindert ein Durchrutschen des Steckschlüssels. Diese Steckschlüssel eignen sich besonders für polierte Schrauben, Aluminium Schrauben und Schrauben bei denen die Ecken bereits abgerundet sind.

Notre profil Surface Drive assure le contact entre la douille et les plats de l'écrou. Ceci réduit l'usure et permet la transmission d'un couple plus élevé. C'est une solution idéale pour les écrous polies, celles en aluminium ou arrondies.

1/4"

Impact Sockets
Impact Steckschlüssel
Douilles Impact

Z-SERIES
HAND
TITANIUM
ACCESSORIES
SCREWDRIVERS
IMPACT
SLEEVE-DRIVE
PROTECTOR
INDUSTRIAL
AUTOMOTIVE
MOTORCYCLE
CONSTRUCTION
SPARE PART

12465M (mm)	D ₁ (mm)	D ₂ (mm)	H (mm)	L (mm)	(g)	(pcs.)	
10	15	13	8	23	17	10	*1
11	16.3	13	8	23	18	10	*1
12	17.5	13	9	23	18	10	*1
13	18.8	13	9	23	20	10	*1

*1 Pin/O-Ring=A21/B21 → P257



12465M Pathfinder Sockets Pathfinder Steckschlüssel Douilles Pathfinder

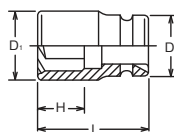

PATHFINDER®

The beveled flats of the 6-points opening of the PATHFINDER socket engage the nut almost immediately. PATHFINDER sockets are ideal for using with power tools in automatic assembly processes, as the power tool does not have to be totally stopped for the socket to engage the nut.

Da die Maschine nicht nach jedem Schraubvorgang angehalten werden muss, ergibt sich eine erhöhte Produktivität, die sich bei vollautomatischen Maschinen (Mehrspindelschrauber) ganz besonders auswirkt.

Les parois en biais des douilles en 6-pans Pathfinder assurent l'engagement quasi immédiat de l'écrou. Le fait de ne pas devoir arrêter la machine après chaque serrage, engendre une productivité supérieure dans les chaînes de montage automatiques.

12425 (E)	D ₁ (mm)	D ₂ (mm)	H (mm)	L (mm)	(g)	(pcs.)	
E 4	6.6	13	4.6	23	14	10	*1
E 5	7.7	13	5.2	23	15	10	*1
E 6	8.7	13	5.4	23	15	10	*1
E 7	9.2	13	6.6	23	15	10	*1
E 8	9.7	13	7	23	15	10	*1
E10	12.2	13	8.2	23	15	10	*1

*1 Pin/O-Ring=A21/B21 → P257

12425 TORX® Sockets TORX® Steckschlüssel Douilles TORX®

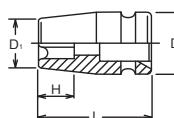

TORX® (E)

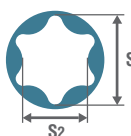

E	E4	E5	E6	E7	E8	E10	E11	E12	E14	E16	E18	E20	E22	E24	E26	E28	E30	E32
S ₁ (ref. mm)	3.7	4.6	5.6	6.1	7.4	9.3	9.9	11.0	12.8	14.6	16.5	18.3	20.1	22.0	23.7	25.5	27.3	29.0
S ₂ (ref. mm)	2.7	3.3	4.0	4.3	5.3	6.8	7.1	7.9	9.2	10.5	11.9	13.2	14.8	15.7	17.5	18.3	20.0	21.3

12460M (mm)	D ₁ (mm)	D ₂ (mm)	H (mm)	L (mm)	(g)	(pcs.)	
5.5	9.7	13	4	23	15	10	*1
6	10.3	13	5	23	15	10	*1
7	11.6	13	5	23	16	10	*1
8	12.8	13	6	23	16	10	*1
10	15.3	13	7	23	19	10	*1
13	19.1	13	8	23	23	10	*1

12460A (inch)	D ₁ (mm)	D ₂ (mm)	H (mm)	L (mm)	(g)	(pcs.)	
1/4	10.3	13	5	23	15	10	*1
5/16	12.8	13	6	23	16	10	*1
3/8	15.3	13	7	23	19	10	*1
1/2	19.1	13	8	23	23	10	*1

*1 Pin/O-Ring=A21/B21 → P257

12460M / 12460A For Self-Tapping Screws Für selbstschneidende Schrauben Pour vis auto-taraudeuses

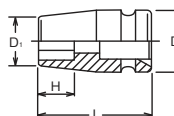

Socket for Self-Tapping Screws without infeed slope.

Steckschlüssel für selbstschneidende Schrauben 6-kant ohne Einlaufschräge.

Douille pour vis auto-taraudeuses hexagonales sans biseau d'entrée.

12460MG (mm)	D ₁ (mm)	D ₂ (mm)	H (mm)	L (mm)	(g)	(pcs.)	
5.5	9.7	13	2.1	23	16	10	*1
6	10.3	13	2.4	23	16	10	*1
7	11.6	13	2.8	23	16	10	*1
8	12.8	13	3.5	25	18	10	*1
10	15.3	13	4.2	28	20	10	*1
12	17.9	13	8	30	41	10	*1
13	19.1	13	6	30	23	10	*1
14	20	13	6.4	30	24	10	*1

12460AG (inch)	D ₁ (mm)	D ₂ (mm)	H (mm)	L (mm)	(g)	(pcs.)	
1/4	10.3	13	2.4	23	16	10	*1
5/16	12.8	13	3.5	25	18	10	*1
3/8	15.3	13	4.2	28	20	10	*1
7/16	16.6	13	4.9	29	27	10	*1
1/2	19.1	13	6	30	23	10	*1

*1 Pin/O-Ring=A21/B21 → P257

12460MG / 12460AG

With Magnet for Self-Tapping Screws
mit Magnet für selbstschneidende Schrauben
avec aimant pour vis auto-taraudeuses

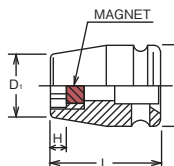

Socket with Magnet for Self-Tapping Screws without infeed slope.

Steckschlüssel mit Magnet für Selbstschneidende Schrauben 6-kant ohne Einlaufschräge.

Douille avec aimant pour vis auto-taraudeuses hexagonales sans biseau d'entrée.

Impact Sockets

Impact Steckschlüssel

Douilles Impact

1/4"

Z-SERIES
HAND
TITANIUM
SCREWDRIVERS
ACCESSORIES
IMPACT
SLEEVE-DRIVE
PROTECTOR
INDUSTRIAL
AUTOMOTIVE
MOTORCYCLE
CONSTRUCTION
SPARE PART

12300M

6-point Sockets, deep
6-kant Steckschlüssel, lang
Douilles longues, 6-pans



12300M (mm)	D ₁ (mm)	D ₂ (mm)	H ₁ (mm)	H ₂ (mm)	L (mm)	(g)	(pcs.)	
6	10	13	6	38	48	26	10	*1
7	11.3	13	7	38	48	30	10	*1
8	12.5	13	8	38	48	32	10	*1
10	15	13	10	37	48	34	10	*1
11	16.3	13	11	37	48	46	10	*1
12	17.5	13	12	37	48	49	10	*1
13	18.8	13	13	37	48	52	10	*1
14	20	13	14	36	48	57	10	*1

*1 Pin/O-Ring=A21/B21 → P257

12365M

Pathfinder Sockets, deep
Pathfinder Steckschlüssel, lang
Douilles longues, Pathfinder



12365M (mm)	D ₁ (mm)	D ₂ (mm)	H ₁ (mm)	H ₂ (mm)	L (mm)	(g)	(pcs.)	
10	15	13	8	37	48	34	10	*1
11	16.3	13	8	37	48	46	10	*1
12	17.5	13	9	37	48	49	10	*1
13	18.8	13	9	37	48	52	10	*1

*1 Pin/O-Ring=A21/B21 → P257

12300G

Impact Socket with Sliding Magnet
Impact Steckschlüssel mit versenkbarem Magnet
Douilles Impact avec aimant, glissant pour écrous

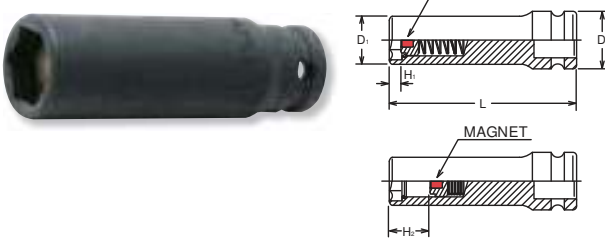

12300G (mm)	D ₁ (mm)	D ₂ (mm)	H ₁ (mm)	H ₂ (mm)	L (mm)	(g)	(pcs.)	
8	12.5	13	4	22	48	32	10	*1
10	15	13	4.5	20.5	48	34	10	*1
12	17.5	13	6	24.5	48	49	10	*1
13	18.8	13	6.5	23	48	52	10	*1
14	20	13	7	21	48	57	10	*1

*1 Pin/O-Ring=A21/B21 → P257

12139

Impact Bit Holder
Impact Klingenhalter
Porte embouts Impact



	D ₁ (mm)	D ₂ (mm)	L (mm)	(g)	(pcs.)	
12139-1/4	11	13	25	15	10	*1

*1 Pin/O-Ring=A21/B21 → P257

For DIN3126 C6.3 Bits
Für DIN3126 C6.3 Bits
Pour DIN3126 C6.3 Embouts

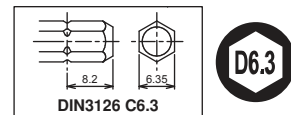

12140

Impact Bit Holder
Impact Klingenhalter
Porte embouts Impact



	D ₁ (mm)	D ₂ (mm)	L (mm)	(g)	(pcs.)	
12140-5/16	14	13	25	15	10	*1

*1 Pin/O-Ring=A21/B21 → P257

For DIN3126 C8 Bits
Für DIN3126 C8 Bits
Pour DIN3126 C8 Embouts

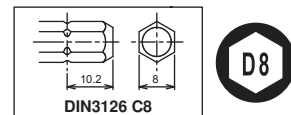

12142-F6.3

Impact Bit Holder
Impact Klingenhalter
Porte embouts Impact



	D ₁ (mm)	D ₂ (mm)	L (mm)	(g)	(pcs.)	
12142-F6.3	16.5	13	40	22	10	*1

*1 Pin/O-Ring=A21/B21 → P257

For DIN3126 E6.3 Bits
Für DIN3126 E6.3 Bits
Pour DIN3126 E6.3 Embouts

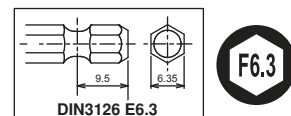

Lock & Quick Release

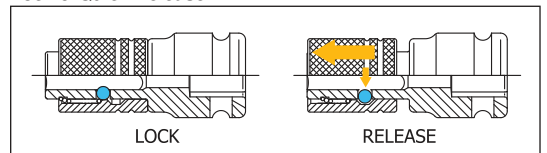

⚠ You may not hold the sliding part while moving to avoid heating up by friction and reduction by wear.

	TYPE	D (mm)	L (mm)	(g)	(pcs.)	
12760-55P	Pin	13	55	26	10	*1
12760-75P	Pin	13	75	45	10	*1
12760-100P	Pin	13	100	50	10	*1
12760-150P	Pin	13	150	60	10	*1
12760-200P	Pin	13	200	80	10	*1

	TYPE	D (mm)	L (mm)	(g)	(pcs.)	
12760-55	Hole	13	55	26	10	*1
12760-75	Hole	13	75	45	10	*1
12760-100	Hole	13	100	50	10	*1
12760-150	Hole	13	150	60	10	*1
New 12760-200	Hole	13	200	80	10	*1

*1 Pin/O-Ring=A21/B21 → P257

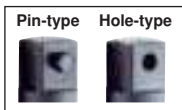

	L (mm)	(g)	(pcs.)	
12222AL	35	30	10	*1

*1 Pin/O-Ring=A21/B21 → P257

Lock & Quick Release

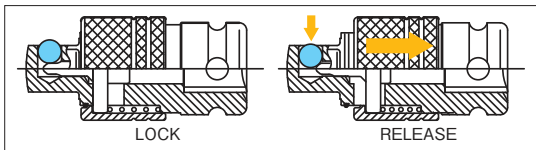

⚠ You may not hold the sliding part while moving to avoid heating up by friction and reduction by wear.



LOCKING ADAPTOR

12760-P 12760

Extension Bars
Verlängerungen
Rallonges

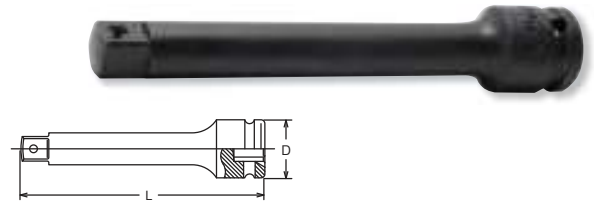

12222AL

Adaptor (Quick Release)
Schnellwechsel-Verbindungsstück
Adaptateur autoserrant ⚠



12770-P 12770

Universal Joint
Gelenk-Einsatz
Joint articulé



	TYPE	L (mm)	(g)	(pcs.)	
12770-P	Pin	39	30	10	*1
12770	Hole	39	30	10	*1

*1 Pin/O-Ring=A21/B21 → P257

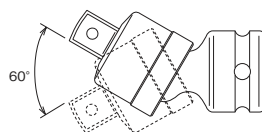

Our ball joints are spring-loaded and can therefore be adjusted to an angle of max. 30°.

Unsere Kugelgelenke sind federbelastet dadurch sind sie auf einen Winkel von max 30° einstellbar.

Nos joints à rotule sont à ressort et peuvent donc être réglés jusqu'à un angle de 30° maximum.

	TYPE	(sq.)	(sq.)	L (mm)	(g)	(pcs.)	
12233A-P	Pin	1/4"	3/8"	22	15	10	*1
12233A	Hole	1/4"	3/8"	22	15	10	*1

*1 Pin/O-Ring=A21/B21 → P257

12233A-P 12233A

Adaptor
Verbindungsstück
Augmenteur



Impact Sockets Impact Steckschlüssel Douilles Impact

3/8"

Z-SERIES

HAND

TITANIUM

SCREWDRIVERS ACCESSORIES

IMPACT

SLEEVE-DRIVE

PROTECTOR

INDUSTRIAL

AUTOMOTIVE

MOTORCYCLE

CONSTRUCTION

SPARE PART

13400M / 13400A



6-point Sockets
6-kant Steckschlüssel
Douilles 6-pans

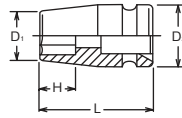

13400A (inch)	D ₁ (mm)	D ₂ (mm)	H (mm)	L (mm)	(g)	(pcs.)	
1/4	10.8	19	5	32	40	10	*1
5/16	13.3	19	6	32	40	10	*1
3/8	15.8	19	7	32	40	10	*1
7/16	17	19	8	32	41	10	*1
1/2	19.5	22	10	32	56	10	*2
9/16	20.8	22	10	32	56	10	*2
5/8	23.3	22	11	32	57	10	*2
11/16	24.5	22	12	32	60	10	*2
3/4	27	22	12	32	67	10	*2
13/16	29.5	22	12	32	71	10	*2
7/8	30.8	22	13	32	72	10	*2

*1 C-Ring=C31, Pin/O-Ring=A31/B31

→ P256-257

*2 C-Ring=C32, Pin/O-Ring=A32/B32

13400M (mm)	D ₁ (mm)	D ₂ (mm)	H (mm)	L (mm)	(g)	(pcs.)	
6	10.8	19	5	32	40	10	*1
7	12	19	5	32	40	10	*1
8	13.3	19	6	32	40	10	*1
9	14.5	19	7	32	40	10	*1
10	15.8	19	7	32	40	10	*1
11	17	19	8	32	41	10	*1
12	18.3	19	9	32	43	10	*1
13	19.5	22	10	32	56	10	*2
14	20.8	22	10	32	56	10	*2
15	22	22	11	32	56	10	*2
16	23.3	22	11	32	57	10	*2
17	24.5	22	12	32	60	10	*2
18	25.8	22	12	32	62	10	*2
19	27	22	12	32	67	10	*2
20	28.3	22	12	32	70	10	*2
21	29.5	22	12	32	71	10	*2
22	30.8	22	13	32	72	10	*2
23	32	22	13	32	75	10	*2
24	33.3	22	13	32	78	10	*2

*1 C-Ring=C31, Pin/O-Ring=A31/B31

→ P256-257

*2 C-Ring=C32, Pin/O-Ring=A32/B32

13405M / 13405A



12-point Sockets
12-kant Steckschlüssel
Douilles 12-pans

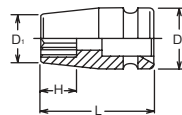

13405A (inch)	D ₁ (mm)	D ₂ (mm)	H (mm)	L (mm)	(g)	(pcs.)	
1/4	10.8	19	5	32	40	10	*1
5/16	13.3	19	6	32	40	10	*1
3/8	15.8	19	7	32	40	10	*1
7/16	17	19	8	32	41	10	*1
1/2	19.5	22	10	32	56	10	*2
9/16	20.8	22	10	32	56	10	*2
5/8	23.3	22	11	32	57	10	*2
11/16	24.5	22	12	32	60	10	*2
3/4	27	22	12	32	67	10	*2
13/16	29.5	22	12	32	71	10	*2
7/8	30.8	22	13	32	72	10	*2

*1 C-Ring=C31, Pin/O-Ring=A31/B31

→ P256-257

*2 C-Ring=C32, Pin/O-Ring=A32/B32

13405M (mm)	D ₁ (mm)	D ₂ (mm)	H (mm)	L (mm)	(g)	(pcs.)	
8	13.3	19	6	32	40	10	*1
9	14.5	19	7	32	40	10	*1
10	15.8	19	7	32	40	10	*1
11	17	19	8	32	41	10	*1
12	18.3	19	9	32	43	10	*1
13	19.5	22	10	32	56	10	*2
14	20.8	22	10	32	56	10	*2
15	22	22	11	32	56	10	*2
16	23.3	22	11	32	57	10	*2
17	24.5	22	12	32	60	10	*2
18	25.8	22	12	32	62	10	*2
19	27	22	12	32	67	10	*2

*1 C-Ring=C31, Pin/O-Ring=A31/B31

→ P256-257

*2 C-Ring=C32, Pin/O-Ring=A32/B32

13400MG / 13400AG



6-point Sockets with Magnet
6-kant Steckschlüssel mit Magnet
Douilles 6-pans avec aimant

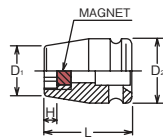

13400AG (inch)	D ₁ (mm)	D ₂ (mm)	H (mm)	L (mm)	(g)	(pcs.)	
1/4	10.8	19	2.4	32	46	10	*1
5/16	13.3	19	3.5	32	45	10	*1
11/32	14.5	19	3.8	32	44	10	*1
3/8	15.8	19	4.2	32	49	10	*1
7/16	17	19	4.9	32	50	10	*1
1/2	19.5	22	6	32	70	10	*2
9/16	20.8	22	6.4	32	76	10	*2
5/8	23.3	22	7	32	88	10	*2
11/16	24.5	22	7.5	32	95	10	*2
3/4	27	22	8	32	116	10	*2

*1 C-Ring=C31, Pin/O-Ring=A31/B31

→ P256-257

*2 C-Ring=C32, Pin/O-Ring=A32/B32

13400MG (mm)	D ₁ (mm)	D ₂ (mm)	H (mm)	L (mm)	(g)	(pcs.)	
6	10.8	19	2.4	32	46	10	*1
7	12	19	2.8	32	45	10	*1
8	13.3	19	3.5	32	45	10	*1
9	14.5	19	3.8	32	44	10	*1
10	15.8	19	4.2	32	49	10	*1
11	17	19	4.9	32	50	10	*1
12	18.3	19	5.6	32	55	10	*1
13	19.5	22	6	32	70	10	*2
14	20.8	22	6.4	32	76	10	*2
15	22	22	6.8	32	76	10	*2
16	23.3	22	7	32	88	10	*2
17	24.5	22	7.5	32	95	10	*2
18	25.8	22	7.8	32	105	10	*2
19	27	22	8	32	116	10	*2
21	29.5	22	8	32	125	10	*2
22	30.8	22	9.5	32	135	10	*2

*1 C-Ring=C31, Pin/O-Ring=A31/B31

→ P256-257

*2 C-Ring=C32, Pin/O-Ring=A32/B32

3/8"

Impact Sockets Impact Steckschlüssel Douilles Impact

13401M (mm)	D ₁ (mm)	D ₂ (mm)	H (mm)	L (mm)	(g)	(pcs.)	
6	9.8	18.5	5	32	28	10	*1
7	11	18.5	5	32	30	10	*1
8	12.3	18.5	6	32	31	10	*1
9	13.5	18.5	7	32	32	10	*1
10	14.8	18.5	7	32	34	10	*1
11	16	18.5	8	32	35	10	*1
12	17.3	18.5	9	32	36	10	*1
13	18.5	21.5	10	32	43	10	*2
14	19.8	21.5	10	32	49	10	*2
15	21	21.5	11	32	49	10	*2
16	22.3	21.5	11	32	51	10	*2
17	23.5	21.5	12	32	54	10	*2
18	24.8	21.5	12	32	57	10	*2
19	26	21.5	12	32	60	10	*2
20	27.3	21.5	12	32	65	10	*2
21	28.5	21.5	12	32	70	10	*2
22	29.8	21.5	13	32	73	10	*2
23	31	21.5	13	32	73	10	*2
24	32.3	21.5	13	32	75	10	*2

*1 C-Ring=C31, Pin/O-Ring=A31/B31
*2 C-Ring=C32, Pin/O-Ring=A32/B32 → P256-257

RS13401M/9	9 Pieces Set/Rail 250mm	(g)
8, 10, 12, 13, 14, 17, 19, 21, 22		505

13401M / 13401A

6-point Socket, Thin Walled
6-kant Steckschlüssel, dünnwandig
Douilles à paroi mince, 6-pans

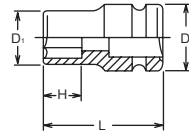

13401A (inch)	D ₁ (mm)	D ₂ (mm)	H (mm)	L (mm)	(g)	(pcs.)	
1/4	9.8	18.5	5	32	28	10	*1
5/16	12.3	18.5	6	32	31	10	*1
3/8	14.8	18.5	7	32	34	10	*1
7/16	16	18.5	8	32	35	10	*1
1/2	18.5	21.5	10	32	43	10	*2
9/16	19.8	21.5	10	32	49	10	*2
5/8	22.3	21.5	11	32	51	10	*2
11/16	23.5	21.5	12	32	54	10	*2
3/4	26	21.5	12	32	60	10	*2
13/16	28.5	21.5	12	32	70	10	*2
7/8	29.8	21.5	13	32	73	10	*2

*1 C-Ring=C31, Pin/O-Ring=A31/B31
*2 C-Ring=C32, Pin/O-Ring=A32/B32 → P256-257

RS13401M/9

Socket Set on Rail
Steckschlüsselsatz auf Schiene
Jeu de douilles sur rail



13406M / 13406A

12-point Socket, Thin Walled
12-kant Steckschlüssel, dünnwandig
Douilles à paroi mince, 12-pans

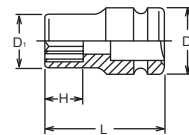

13406M (mm)	D ₁ (mm)	D ₂ (mm)	H (mm)	L (mm)	(g)	(pcs.)	
6	9.8	18.5	5	32	28	10	*1
7	11	18.5	5	32	30	10	*1
8	12.3	18.5	6	32	31	10	*1
9	13.5	18.5	7	32	32	10	*1
10	14.8	18.5	7	32	34	10	*1
11	16	18.5	8	32	35	10	*1
12	17.3	18.5	9	32	36	10	*1
13	18.5	21.5	10	32	43	10	*2
14	19.8	21.5	10	32	49	10	*2
15	21	21.5	11	32	49	10	*2
16	22.3	21.5	11	32	51	10	*2
17	23.5	21.5	12	32	54	10	*2
18	24.8	21.5	12	32	57	10	*2
19	26	21.5	12	32	60	10	*2
20	27.3	21.5	12	32	65	10	*2
21	28.5	21.5	12	32	70	10	*2
22	29.8	21.5	13	32	73	10	*2
23	31	21.5	13	32	73	10	*2
24	32.3	21.5	13	32	75	10	*2

*1 C-Ring=C31, Pin/O-Ring=A31/B31
*2 C-Ring=C32, Pin/O-Ring=A32/B32 → P256-257

13406A (inch)	D ₁ (mm)	D ₂ (mm)	H (mm)	L (mm)	(g)	(pcs.)	
1/4	9.8	18.5	5	32	28	10	*1
5/16	12.3	18.5	6	32	31	10	*1
3/8	14.8	18.5	7	32	34	10	*1
7/16	16	18.5	8	32	35	10	*1
1/2	18.5	21.5	10	32	43	10	*2
9/16	19.8	21.5	10	32	49	10	*2
5/8	22.3	21.5	11	32	51	10	*2
11/16	23.5	21.5	12	32	54	10	*2
3/4	26	21.5	12	32	60	10	*2
13/16	28.5	21.5	12	32	70	10	*2
7/8	29.8	21.5	13	32	73	10	*2

*1 C-Ring=C31, Pin/O-Ring=A31/B31
*2 C-Ring=C32, Pin/O-Ring=A32/B32 → P256-257

13401MS (mm)	D ₁ (mm)	D ₂ (mm)	H (mm)	L (mm)	(g)	(pcs.)	
8	12.3	18.5	6	22	25	10	*1
10	14.8	18.5	6	22	25	10	*1
11	16	18.5	10	22	24	10	*1
12	17.3	18.5	10	22	20	10	*1
13	18.5	21.5	10	22	30	10	*2
14	19.8	21.5	10	22	30	10	*2
15	20.9	21.5	10	25	38	10	*2
16	22.3	21.5	10	25	39	10	*2
17	23.5	21.5	10	25	41	10	*2
18	24.8	21.5	10	25	43	10	*2
19	26	21.5	10	25	44	10	*2

*1 C-Ring=C31, Pin/O-Ring=A31/B31
*2 C-Ring=C32, Pin/O-Ring=A32/B32 → P256-257

RS13401MS/11	11 Pieces Set/Rail 300mm	(g)
8, 10, 11, 12, 13, 14, 15, 16, 17, 18, 19		400

13401MS

6-point short sockets, Thin Walled
6-kant Steckschlüssel kurz, dünnwandig
Douilles 6-pans courtes, a paroi mince

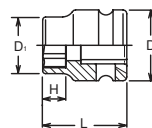

RS13401MS/11

Socket Set on Rail
Steckschlüsselsatz auf Schiene
Jeu de douilles sur rail



Impact Sockets

Impact Steckschlüssel

Douilles Impact

3/8"

Z-SERIES
HAND
TITANIUM
SCREWDRIVERS ACCESSORIES
IMPACT
SLEEVE-DRIVE
PROTECTOR
INDUSTRIAL
AUTOMOTIVE
MOTORCYCLE
CONSTRUCTION
SPARE PART

13410M

Surface Drive Sockets
Surface Drive Steckschlüssel
Douilles, Surface Drive

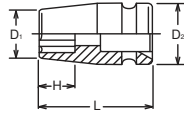

13410M (mm)	D ₁ (mm)	D ₂ (mm)	H (mm)	L (mm)	(g)	(pcs.)	
6	10.8	19	5	32	40	10	*1
7	12	19	5	32	40	10	*1
8	13.3	19	6	32	40	10	*1
9	14.5	19	7	32	40	10	*1
10	15.8	19	7	32	40	10	*1
11	17	19	8	32	42	10	*1
12	18.3	19	9	32	50	10	*1
13	19.5	22	10	32	56	10	*2
14	20.8	22	10	32	56	10	*2
15	22	22	11	32	56	10	*2
16	23.3	22	11	32	57	10	*2
17	24.5	22	12	32	60	10	*2
18	25.8	22	12	32	62	10	*2
19	27	22	12	32	67	10	*2
22	30.8	22	13	32	72	10	*2

*1 C-Ring=C31, Pin/O-Ring=A31/B31 → P256-257
*2 C-Ring=C32, Pin/O-Ring=A32/B32

13465M

Pathfinder Sockets
Pathfinder Steckschlüssel
Douilles Pathfinder

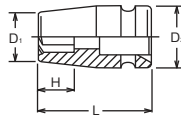

13465M (mm)	D ₁ (mm)	D ₂ (mm)	H (mm)	L (mm)	(g)	(pcs.)	
8	13.3	19	8	32	40	10	*1
10	15.8	19	8	32	43	10	*1
11	17	19	8	32	44	10	*1
12	18.3	19	9	32	47	10	*1
13	19.5	22	9	32	55	10	*2
14	20.8	22	11	32	56	10	*2
15	22	22	11	32	56	10	*2
16	23.3	22	11	32	57	10	*2
17	24.5	22	12	32	60	10	*2
18	25.8	22	13	32	63	10	*2
19	27	22	13	32	66	10	*2

*1 C-Ring=C31, Pin/O-Ring=A31/B31 → P256-257
*2 C-Ring=C32, Pin/O-Ring=A32/B32

13425

TORX® Sockets
TORX® Steckschlüssel
Douilles TORX®

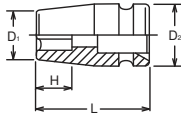

13425 (E)	D ₁ (mm)	D ₂ (mm)	H (mm)	L (mm)	(g)	(pcs.)	
E 4	9.7	19	4.6	32	44	10	*1
E 5	10.2	19	5.2	32	43	10	*1
E 6	10.7	19	5.4	32	44	10	*1
E 7	11.2	19	6.6	32	44	10	*1
E 8	11.7	19	7	32	44	10	*1
E10	12.2	19	8.2	32	42	10	*1
E11	13.2	19	8.7	32	43	10	*1
E12	14.2	19	9.3	32	43	10	*1
E14	17.2	19	10.6	32	44	10	*1
E16	18.2	19	11.8	32	42	10	*1

*1 C-Ring=C31, Pin/O-Ring=A31/B31 → P256-257

13425EG

TORX® Sockets with Magnet
TORX® Steckschlüssel mit Magnet
Douilles TORX® avec aimant

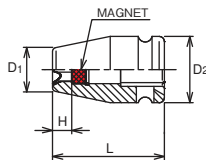

13425EG (E)	D ₁ (mm)	D ₂ (mm)	H (mm)	L (mm)	(g)	(pcs.)	
E 8	11.7	19	5	32	54	10	*1
E10	12.2	19	5.5	32	52	10	*1
E12	14.2	19	6.5	32	53	10	*1
E14	17.2	19	7	32	54	10	*1

*1 C-Ring=C31, Pin/O-Ring=A31/B31 → P256-257

13425-EPL

TORXPLUS® Sockets
TORXPLUS® Steckschlüssel
Douilles TORXPLUS®

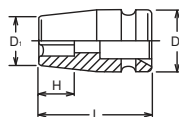

13425 (EPL)	D ₁ (mm)	D ₂ (mm)	H (mm)	L (mm)	(g)	(pcs.)	
8EPL	11.7	19	5.2	32	44	10	*1
10EPL	12.2	19	6.2	32	44	10	*1
12EPL	14.2	19	7.2	32	44	10	*1
14EPL	17.2	19	8.1	32	46	10	*1
16EPL	18.2	19	9.2	32	41	10	*1

*1 C-Ring=C31, Pin/O-Ring=A31/B31 → P256-257

13460M (mm)	D ₁ (mm)	D ₂ (mm)	H (mm)	L (mm)	(g)	(pcs.)	
6	11.4	19	5	32	43	10	*1
7	12.8	19	5	32	44	10	*1
8	14.1	19	6	32	44	10	*1
10	16.6	19	7	32	45	10	*1
12	19	19.2	9	32	48	10	*2
13	20.3	22	10	32	60	10	*2

13460A (inch)	D ₁ (mm)	D ₂ (mm)	H (mm)	L (mm)	(g)	(pcs.)	
1/4	11.4	19	5	32	43	10	*1
3/8	16.6	19	7	32	45	10	*1
1/2	20.3	22	10	32	60	10	*2

*1 C-Ring=C31, Pin/O-Ring=A31/B31 → P256-257
*2 C-Ring=C32, Pin/O-Ring=A32/B32

13460MG (mm)	D ₁ (mm)	D ₂ (mm)	H (mm)	L (mm)	(g)	(pcs.)	
6	11.4	19	2.4	32	44	10	*1
7	12.8	19	2.8	32	46	10	*1
8	14.1	19	3.5	32	48	10	*1
10	16.6	19	4.2	33	54	10	*1
13	20.3	22	6	34	81	10	*2

13460AG (inch)	D ₁ (mm)	D ₂ (mm)	H (mm)	L (mm)	(g)	(pcs.)	
1/4	11.4	19	2.4	32	44	10	*1
5/16	14.1	19	3.5	32	48	10	*1
3/8	16.6	19	4.2	33	54	10	*1
1/2	20.3	22	6	34	81	10	*2

*1 C-Ring=C31, Pin/O-Ring=A31/B31 → P256-257
*2 C-Ring=C32, Pin/O-Ring=A32/B32

13401LH (LH-S)	D ₁ (mm)	D ₂ (mm)	H (mm)	L (mm)	(g)	(pcs.)	
5S	11	19	5	32	32	10	*1
6S	12.3	19	5.6	32	34	10	*1
8S	16	19	6.8	32	36	10	*1
10S	18.5	22	8	32	50	10	*2
12S	22.3	22	9.2	32	58	10	*2
14S	24.8	22	10.4	32	63	10	*2
16S	28.5	22	11.6	32	77	10	*2

*1 C-Ring=C31, Pin/O-Ring=A31/B31 → P256-257
*2 C-Ring=C32, Pin/O-Ring=A32/B32

LHSTIX®

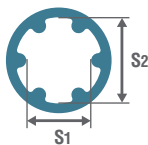

LH-S		LH-5S	LH-6S	LH-8S	LH-10S	LH-12S	LH-14S	LH-16S
S ₁	(ref. mm)	5.6	6.8	9.0	11.3	13.6	15.8	18.1
S ₂	(ref. mm)	7.5	9.0	12.0	15.0	18.0	21.0	24.0

13400-WN	D ₁ (mm)	D ₂ (mm)	H (mm)	L (mm)	(g)	(pcs.)	
6WN	15.8	19	6	32	48	10	*1
8WN	18.3	19	8	32	48	10	*1
9WN	19.5	22	9	32	47	10	*2
10WN	20.8	22	10	32	65	10	*2
12WN	24.5	22	12	32	73	10	*2
14WN	27	22	14	32	79	10	*2
17WN	32	22	17	35	110	10	*2

*1 C-Ring=C31, Pin/O-Ring=A31/B31 → P256-257
*2 C-Ring=C32, Pin/O-Ring=A32/B32

WN



WN		6WN	8WN	9WN	10WN	12WN	14WN	17WN
S	(ref. mm)	6	8	9	10	12	14	17

13460M / 13460A

For Self-Tapping Screws
Für selbstschneidende Schrauben
Pour vis auto-taraudeuses

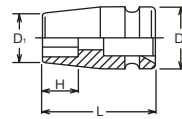

Socket for Self-Tapping Screws without infeed slope.

Steckschlüssel für selbstschneidende Schrauben 6-kant ohne Einlaufschräge.

Douille pour vis auto-taraudeuses hexagonales sans biseau d'entrée.

13460MG / 13460AG

Sockets with magnets for Self-Tapping Screws
Steckschlüssel mit Magnet für selbstschneidende Schrauben
Douilles avec aimant pour vis auto-taraudeuses

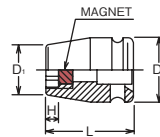

Socket with Magnet for Self-Tapping Screws without infeed slope.

Steckschlüssel mit Magnet für Selbstschneidende Schrauben 6-kant ohne Einlaufschräge.

Douille avec aimant pour vis auto-taraudeuses hexagonales sans biseau d'entrée.

13401LH

LHS Sockets
Steckschlüssel mit LHS Profil
Douilles au profil LHS

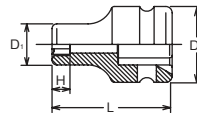

13400-WN

Weld Nut Sockets
Steckschlüssel für Schweissmuttern
Douilles pour écrou à souder

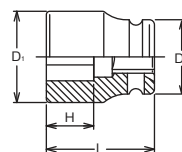

Impact Sockets

Impact Steckschlüssel

Douilles Impact

3/8"

Z-SERIES
HAND
TITANIUM
SCREWDRIVERS ACCESSORIES
IMPACT
SLEEVE-DRIVE
PROTECTOR
INDUSTRIAL
AUTOMOTIVE
MOTORCYCLE
CONSTRUCTION
SPARE PART

13301X  6-point Semi-Deep Socket, Thin Walled
6-kant Steckschlüssel mittel lang, dünnwandig
Douilles à paroi mince semi-longues, 6-pans

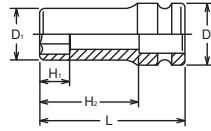

13301X (mm)	D ₁ (mm)	D ₂ (mm)	H ₁ (mm)	H ₂ (mm)	L (mm)	(g)	(pcs.)	
6	9.8	18.5	6	36.5	50	35	10	*1
7	11	18.5	7	36.5	50	40	10	*1
8	12.3	18.5	8	36.5	50	40	10	*1
10	14.8	18.5	10	36.5	50	46	10	*1
11	16	18.5	11	36.5	50	49	10	*1
12	17.3	18.5	12	36.5	50	53	10	*1
13	18.5	21.5	13	36.5	50	67	10	*2
14	19.8	21.5	14	36.5	50	70	10	*2
15	21	21.5	15	35.5	50	75	10	*2
16	22.3	21.5	16	35.5	50	78	10	*2
17	23.5	21.5	17	35.5	50	82	10	*2
18	24.8	21.5	18	34.5	50	86	10	*2
19	26	21.5	19	34.5	50	93	10	*2
21	28.5	21.5	21	34.5	50	104	10	*2
22	29.8	21.5	22	33.5	50	110	10	*2
23	31	21.5	23	33.5	50	115	10	*2
24	32.3	21.5	24	32.5	50	120	10	*2

*1 C-Ring=C31, Pin/O-Ring=A31/B31 → P256-257
*2 C-Ring=C32, Pin/O-Ring=A32/B32

RS13301X/9  Socket Set on Rail
Steckschlüsselsatz auf Schiene
Jeu de douilles sur rail



RS13301X/9	9 Pieces Set/Rail 250mm	(g)
8, 10, 12, 13, 14, 17, 19, 21, 22		710

13300XG  Impact semi-deep socket with Sliding Magnet
Impact Steckschlüssel mittel lang mit versenkbarem Magnet
Douilles semi-longues avec aimant, glissant pour écrous

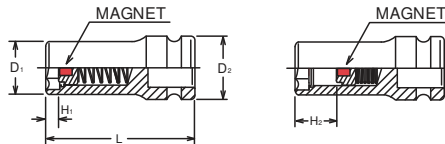

13300XG (mm)	D ₁ (mm)	D ₂ (mm)	H ₁ (mm)	H ₂ (mm)	L (mm)	(g)	(pcs.)	
7	12	19	3.5	19	50	52	10	*1
8	13.3	19	4	20.5	50	40	10	*1
10	15.8	19	4.5	20	50	46	10	*1
11	17	19	5	20	50	50	10	*1
12	18.3	19	6	20	50	55	10	*1
13	19.5	22	6.5	19	50	70	10	*2
14	20.8	22	7	18	50	75	10	*2
15	21.9	22	7	18	50	85	10	*2
16	23.2	22	7.5	20	50	114	10	*2
17	24.4	22	8	20	50	126	10	*2

*1 C-Ring=C31, Pin/O-Ring=A31/B31 → P256-257
*2 C-Ring=C32, Pin/O-Ring=A32/B32

13300M / 13300A  6-point Sockets, deep
6-kant Steckschlüssel, lang
Douilles longues, 6-pans

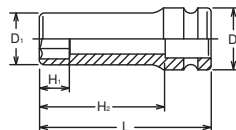

13300M (mm)	D ₁ (mm)	D ₂ (mm)	H ₁ (mm)	H ₂ (mm)	L (mm)	(g)	(pcs.)	
6	10.8	19	6	66.5	80	77	10	*1
7	12	19	7	66.5	80	82	10	*1
8	13.3	19	8	66.5	80	82	10	*1
9	14.5	19	9	66.5	80	88	10	*1
10	15.8	19	10	66.5	80	94	10	*1
11	17	19	11	66.5	80	110	10	*1
12	18.3	19	12	66.5	80	111	10	*1
13	19.5	22	13	66.5	80	138	10	*2
14	20.8	22	14	66.5	80	148	10	*2
15	22	22	15	65.5	80	157	10	*2
16	23.3	22	16	65.5	80	156	10	*2
17	24.5	22	17	65.5	80	168	10	*2
18	25.8	22	18	64.5	80	190	10	*2
19	27	22	19	64.5	80	192	10	*2
20	28.3	22	20	64.5	80	224	10	*2
21	29.5	22	21	64.5	80	226	10	*2
22	30.8	22	22	63.5	80	231	10	*2
24	33.2	22	24	63.5	80	242	10	*2

13300A (inch)	D ₁ (mm)	D ₂ (mm)	H ₁ (mm)	H ₂ (mm)	L (mm)	(g)	(pcs.)	
1/4	10.8	19	6	66.5	80	77	10	*1
5/16	13.3	19	8	66.5	80	82	10	*1
3/8	15.8	19	10	66.5	80	94	10	*1
7/16	17	19	11	66.5	80	110	10	*1
1/2	19.5	22	13	66.5	80	138	10	*2
9/16	20.8	22	14	66.5	80	148	10	*2
5/8	23.3	22	16	65.5	80	156	10	*2
11/16	24.5	22	17	65.5	80	168	10	*2
3/4	27	22	19	64.5	80	192	10	*2
13/16	29.5	22	21	64.5	80	226	10	*2
7/8	30.8	22	22	63.5	80	231	10	*2

*1 C-Ring=C31, Pin/O-Ring=A31/B31 → P256-257
*2 C-Ring=C32, Pin/O-Ring=A32/B32

13301M (mm)	D ₁ (mm)	D ₂ (mm)	H ₁ (mm)	H ₂ (mm)	L (mm)	(g)	(pcs.)	
6	10	18.5	6	66.5	80	65	10	*1
7	11	18.5	7	66.5	80	66	10	*1
8	12.3	18.5	8	66.5	80	68	10	*1
9	13.5	18.5	9	66.5	80	70	10	*1
10	14.8	18.5	10	66.5	80	72	10	*1
11	16	18.5	11	66.5	80	80	10	*1
12	17.3	18.5	12	66.5	80	85	10	*1
13	18.5	21.5	13	66.5	80	100	10	*2
14	19.8	21.5	14	66.5	80	110	10	*2
15	21	21.5	15	65.5	80	120	10	*2
16	22.3	21.5	16	65.5	80	130	10	*2
17	23.5	21.5	17	65.5	80	136	10	*2
18	24.8	21.5	18	64.5	80	145	10	*2
19	26	21.5	19	64.5	80	155	10	*2
20	27.3	21.5	20	64.5	80	170	10	*2
21	28.5	21.5	21	64.5	80	181	10	*2
22	29.8	21.5	22	63.5	80	190	10	*2
24	32.3	21.5	24	63.5	80	216	10	*2

13301A (inch)	D ₁ (mm)	D ₂ (mm)	H ₁ (mm)	H ₂ (mm)	L (mm)	(g)	(pcs.)	
1/4	10	18.5	6	66.5	80	65	10	*1
5/16	12.3	18.5	8	66.5	80	68	10	*1
3/8	14.8	18.5	10	66.5	80	72	10	*1
7/16	16	18.5	11	66.5	80	80	10	*1
1/2	18.5	21.5	13	66.5	80	100	10	*2
9/16	19.8	21.5	14	66.5	80	110	10	*2
5/8	22.3	21.5	16	65.5	80	130	10	*2
11/16	23.5	21.5	17	65.5	80	136	10	*2
3/4	26	21.5	19	64.5	80	155	10	*2
13/16	28.5	21.5	21	64.5	80	181	10	*2
7/8	29.8	21.5	22	63.5	80	190	10	*2

*1 C-Ring=C31, Pin/O-Ring=A31/B31 → P256-257
*2 C-Ring=C32, Pin/O-Ring=A32/B32

13305M (mm)	D ₁ (mm)	D ₂ (mm)	H ₁ (mm)	H ₂ (mm)	L (mm)	(g)	(pcs.)	
8	13.3	19	8	66.5	80	82	10	*1
10	15.8	19	10	66.5	80	94	10	*1
11	17	19	11	66.5	80	110	10	*1
12	18.3	19	12	66.5	80	111	10	*1
13	19.5	22	13	66.5	80	138	10	*2
14	20.8	22	14	66.5	80	148	10	*2
17	24.5	22	17	65.5	80	168	10	*2

*1 C-Ring=C31, Pin/O-Ring=A31/B31 → P256-257
*2 C-Ring=C32, Pin/O-Ring=A32/B32

13306M (mm)	D ₁ (mm)	D ₂ (mm)	H ₁ (mm)	H ₂ (mm)	L (mm)	(g)	(pcs.)	
8	12.3	18.5	8	66.5	80	68	10	*1
10	14.8	18.5	10	66.5	80	72	10	*1
11	16	18.5	11	66.5	80	80	10	*1
12	17.3	18.5	12	66.5	80	85	10	*1
13	18.5	21.5	13	66.5	80	100	10	*2
14	19.8	21.5	14	66.5	80	110	10	*2
17	23.5	21.5	17	66.5	80	136	10	*2

*1 C-Ring=C31, Pin/O-Ring=A31/B31 → P256-257
*2 C-Ring=C32, Pin/O-Ring=A32/B32

13301M / 13301A

6-point Deep Socket, Thin Walled
6-kant Steckschlüssel, dünnwandig
Douilles à paroi mince longues, 6-pans

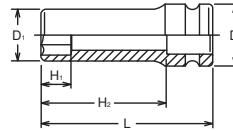

13305M

12-point Sockets, deep
12-kant Steckschlüssel, lang
Douilles longues, 12-pans

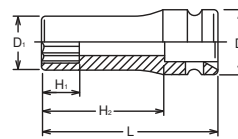

13306M

12-point Deep Sockets, Thin Walled
12-kant Steckschlüssel, dünnwandig
Douilles à paroi mince longues, 12-pans

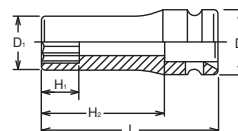

Impact Sockets Impact Steckschlüssel Douilles Impact

3/8"

Z-SERIES
HAND
TITANIUM
SCREWDRIVERS ACCESSORIES
IMPACT
SLEEVE-DRIVE
PROTECTOR
INDUSTRIAL
AUTOMOTIVE
MOTORCYCLE
CONSTRUCTION
SPARE PART

13300G

Impact Socket with Sliding Magnet
Impact Steckschlüssel mit versenkbarem Magnet
Douilles Impact avec aimant, glissant pour écrous

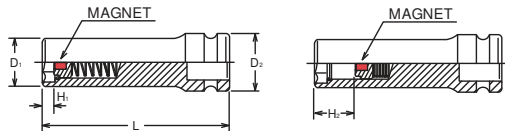

13300G (mm)	D ₁ (mm)	D ₂ (mm)	H ₁ (mm)	H ₂ (mm)	L (mm)	(g)	(pcs.)	
8	13.3	19	4	26.5	80	82	10	*1
10	15.8	19	4.5	26	80	105	10	*1
12	18.3	19	6	26	80	136	10	*1
13	19.5	22	6.5	25	80	165	10	*2
14	20.8	22	7	24	80	186	10	*2
15	22	22	7	24	80	195	10	*2
16	23.3	22	8	27	80	210	10	*2
17	24.5	22	8	27	80	220	10	*2
19	27	22	9	28	80	230	10	*2

*1 C-Ring=C31, Pin/O-Ring=A31/B31 → P256-257
*2 C-Ring=C32, Pin/O-Ring=A32/B32

13310M

Surface Drive Sockets, deep
Surface Drive Steckschlüssel, lang
Douilles longues, Surface Drive

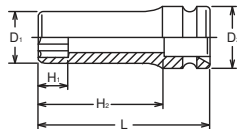

13310M (mm)	D ₁ (mm)	D ₂ (mm)	H ₁ (mm)	H ₂ (mm)	L (mm)	(g)	(pcs.)	
7	12	19	7	66.5	80	77	10	*1
8	13.3	19	8	66.5	80	90	10	*1
9	14.5	19	9	66.5	80	90	10	*1
10	15.8	19	10	66.5	80	97	10	*1
11	17	19	11	66.5	80	110	10	*1
12	18.3	19	12	66.5	80	105	10	*1
13	19.5	22	13	66.5	80	135	10	*2
14	20.8	22	14	66.5	80	145	10	*2
15	22	22	15	65.5	80	160	10	*2
16	23.3	22	16	65.5	80	156	10	*2
17	24.5	22	17	65.5	80	168	10	*2
18	25.8	22	18	64.5	80	190	10	*2
19	27	22	19	64.5	80	190	10	*2

*1 C-Ring=C31, Pin/O-Ring=A31/B31 → P256-257
*2 C-Ring=C32, Pin/O-Ring=A32/B32

13365M

Pathfinder Sockets, deep
Pathfinder Steckschlüssel, lang
Douilles longues, Pathfinder

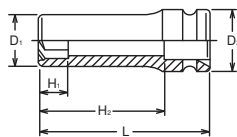

13365M (mm)	D ₁ (mm)	D ₂ (mm)	H ₁ (mm)	H ₂ (mm)	L (mm)	(g)	(pcs.)	
8	13.3	19	7	66.5	80	90	10	*1
10	15.8	19	8	66.5	80	99	10	*1
11	17	19	8	66.5	80	108	10	*1
12	18.3	19	9	66.5	80	110	10	*1
13	19.5	22	9	66.5	80	142	10	*2
14	20.8	22	11	66.5	80	144	10	*2
15	22	22	11	65.5	80	150	10	*2
16	23.3	22	11	65.5	80	159	10	*2
17	24.5	22	12	65.5	80	170	10	*2
18	25.8	22	13	64.5	80	201	10	*2
19	27	22	13	64.5	80	203	10	*2

*1 C-Ring=C31, Pin/O-Ring=A31/B31 → P256-257
*2 C-Ring=C32, Pin/O-Ring=A32/B32

13325

TORX® Deep Sockets
TORX® Steckschlüssel, lang
Douilles longues TORX®

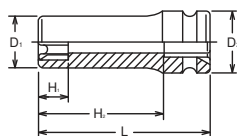

13325 (E)	D ₁ (mm)	D ₂ (mm)	H ₁ (mm)	H ₂ (mm)	L (mm)	(g)	(pcs.)	
E 7	11.2	19	6.6	66.5	80	75	10	*1
E 8	11.7	19	7	66.5	80	80	10	*1
E10	12.2	19	8.2	66.5	80	85	10	*1
E12	14.2	19	9.3	66.5	80	90	10	*1
E14	17.2	19	10.6	66.5	80	110	10	*1
E16	18.2	19	11.8	66.5	80	110	10	*1

*1 C-Ring=C31, Pin/O-Ring=A31/B31 → P256-257

13440M (mm)	D (mm)	H (mm)	L (mm)	(g)	(pcs.)	
10	15.8	5	57	115	10	*1
11	17	6	57	115	10	*1
12	18.3	6	57	115	10	*1
13	19.5	6	57	115	10	*1
14	20.8	7	59	120	10	*1
15	22	7	59	120	10	*1
16	23.3	8	59	120	10	*1
17	24.5	8	59	120	10	*1
18	25.8	9	61	126	10	*1
19	27	10	61	130	10	*1
20	29.5	10	61	135	10	*1
21	30.7	14	66	175	10	*1
22	32	13	66	185	10	*1
24	34.5	13	68	190	10	*1

13440A (inch)	D (mm)	H (mm)	L (mm)	(g)	(pcs.)	
3/8	15.8	5	57	115	10	*1
7/16	17	6	57	115	10	*1
1/2	19.5	6	57	115	10	*1
9/16	20.8	7	59	120	10	*1
5/8	23.3	8	59	120	10	*1
11/16	24.5	8	59	120	10	*1
3/4	27	10	61	130	10	*1

*1 C-Ring=C32, Pin/O-Ring=A32/B32 → P256-257

13440T (E)	D (mm)	H (mm)	L (mm)	(g)	(pcs.)	
E10	13.3	8.2	58	115	10	*1
E12	15.8	9.3	58	115	10	*1
E14	17	10.6	58	115	10	*1

*1 C-Ring=C32, Pin/O-Ring=A32/B32 → P256-257

13430M (mm)	D (mm)	H (mm)	L (mm)	(g)	(pcs.)	
5	24	15	74	120	10	*1
6	24	15	74	131	10	*1
8	24	20	74	136	10	*1
10	24	20	74	141	10	*1
17	24	7	53	150	10	*1

*1 C-Ring=C32, Pin/O-Ring=A32/B32 → P256-257

13103M (mm)	D ₁ (mm)	D ₂ (mm)	H (mm)	L (mm)	(g)	(pcs.)	
5(0.8)	9.5	19	8	32	39	10	*1
6(1.0)	10.8	19	9	32	41	10	*1
7(1.0)	12.5	19	10	32	44	10	*1
8(1.25)	13.5	19	10.5	35	49	10	*1
10(1.25)	15.8	19	13	35	49	10	*1
10(1.5)	15.8	19	13	35	49	10	*1

*1 C-Ring=C31, Pin/O-Ring=A31/B31 → P256-257

⚠ Depend on the stud bolt and using torque, 4103M/13103M/14103M may cause a scratch against the stud bolts or got stuck itself during a work.

A special socket for installing a stud bolt.

Inside steel ball prevent the stud bolt stuck onto the socket. After installing a stud bolt, turn to anti-clockwise to removing the socket.

Spezialwerkzeug zum Setzen von Stehbolzen. Der Bolzen trifft im Werkzeug nur auf den Stahlbolzen, was die Kontaktfläche verringert. Nach dem Setzen des Stehbolzens kann das Werkzeug im Linkslauf vom Stehbolzen abgezogen werden.

Douilles spéciales pour monter les goujons.

Le goujon est en contact avec une bille d'acier pour l'empêcher d'adhérer à la douille. Après avoir posé le goujon, tourner dans le sens antihorlogique pour le retirer

13440M / 13440A

○ Universal Sockets
Gelenk-Einsätze
Douilles universelles

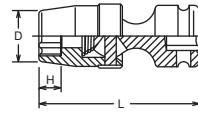

13440T

⬠ TORX® Universal Sockets
TORX® Gelenk-Einsätze
Douilles universelles TORX®

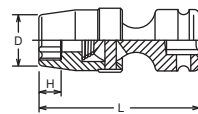

13430M

⬠ Universal Inhex Sockets
Gelenk-Einsätze für Schrauben mit Innensechskant
Douilles universelles 6-pans mâles

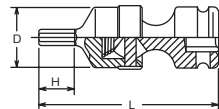

13103M

○ Impact Stud Bolt Setters
Impact Stehbolzensetzer
Monte-goujons Impact ⚠



STUD BOLT SETTER

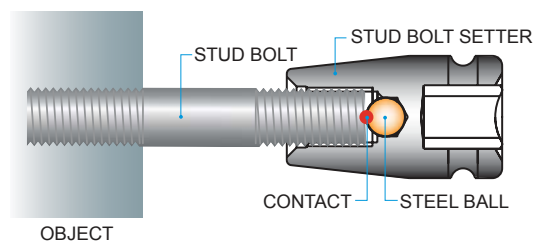
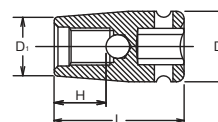

Impact Sockets

Impact Steckschlüssel

Douilles Impact

3/8"

13145M-100 / -150 / -200 / -250

Extra Long Sockets
Schaftsteckschlüssel
Douilles, série allongée

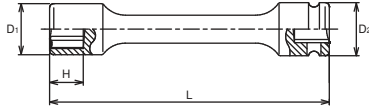

13145M-100 (mm)	D ₁ (mm)	D ₂ (mm)	H (mm)	L (mm)	(g)	(pcs.)	
8	13.3	19	8	100	90	5	*1
10	15.8	19	10	100	92	5	*1
12	18.3	19	12	100	100	5	*1
13	19.5	19	13	100	108	5	*1
14	20.8	19	14	100	112	5	*1
17	24.5	19	17	100	140	5	*1

*1 C-Ring=C31, Pin/O-Ring=A31/B31 → P256-257

13145M-150 (mm)	D ₁ (mm)	D ₂ (mm)	H (mm)	L (mm)	(g)	(pcs.)	
6	10.8	19	6	150	105	5	*1
8	13.3	19	8	150	110	5	*1
10	15.8	19	10	150	120	5	*1
12	18.3	19	12	150	128	5	*1
13	19.5	19	13	150	137	5	*1
14	20.8	19	14	150	146	5	*1
15	22	19	15	150	155	5	*1
17	24.5	19	17	150	163	5	*1

13145M-200 (mm)	D ₁ (mm)	D ₂ (mm)	H (mm)	L (mm)	(g)	(pcs.)	
6	10.8	19	6	200	136	5	*1
8	13.3	19	8	200	141	5	*1
10	15.8	19	10	200	151	5	*1
12	18.3	19	12	200	159	5	*1
13	19.5	19	13	200	168	5	*1
14	20.8	19	14	200	177	5	*1
15	22	19	15	200	186	5	*1
17	24.5	19	17	200	194	5	*1

13145M-250 (mm)	D ₁ (mm)	D ₂ (mm)	H (mm)	L (mm)	(g)	(pcs.)	
6	10.8	19	6	250	167	5	*1
8	13.3	19	8	250	172	5	*1
10	15.8	19	10	250	182	5	*1
12	18.3	19	12	250	190	5	*1
13	19.5	19	13	250	199	5	*1
14	20.8	19	14	250	208	5	*1
15	22	19	15	250	217	5	*1
17	24.5	19	17	250	225	5	*1

*1 C-Ring=C31, Pin/O-Ring=A31/B31 → P256-257

13145MG-100 / -150 / -200

Extra Long Socket with Magnet
Schaftsteckschlüssel mit Magnet
Douilles, série allongée, avec aimant

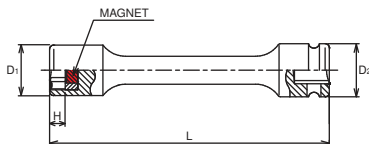

13145MG-100 (mm)	D ₁ (mm)	D ₂ (mm)	H (mm)	L (mm)	(g)	(pcs.)	
8	13.3	19	3.5	100	90	5	*1
10	15.8	19	4.2	100	93	5	*1
12	18.3	19	5.6	100	105	5	*1
13	19.5	19	6	100	115	5	*1
14	20.8	19	6.4	100	120	5	*1

13145MG-150 (mm)	D ₁ (mm)	D ₂ (mm)	H (mm)	L (mm)	(g)	(pcs.)	
New 8	13.3	19	3.5	150	121	5	*1
10	15.8	19	4.2	150	125	5	*1
12	18.3	19	5.6	150	136	5	*1
13	19.5	19	6	150	145	5	*1
14	20.8	19	6.4	150	150	5	*1

13145MG-200 (mm)	D ₁ (mm)	D ₂ (mm)	H (mm)	L (mm)	(g)	(pcs.)	
10	15.8	19	4.2	200	182	5	*1
12	18.3	19	5.6	200	190	5	*1
13	19.5	19	6	200	208	5	*1
14	20.8	19	6.4	200	225	5	*1

*1 C-Ring=C31, Pin/O-Ring=A31/B31 → P256-257

13145M-100 (12P) / -150 (12P) / -200 (12P)

Extra long 12-Point Sockets
Extra lange 12-kant Steckschlüssel
Douilles, série allongée 12 pans

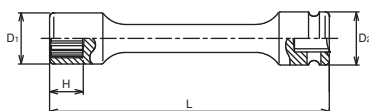

13145M-100 (12P) (mm)	D ₁ (mm)	D ₂ (mm)	H (mm)	L (mm)	(g)	(pcs.)	
10	15.8	19	10	100	91	5	*1
12	18.3	19	12	100	100	5	*1

13145M-150 (12P) (mm)	D ₁ (mm)	D ₂ (mm)	H (mm)	L (mm)	(g)	(pcs.)	
10	15.8	19	10	150	120	5	*1
12	18.3	19	12	150	128	5	*1

13145M-200 (12P) (mm)	D ₁ (mm)	D ₂ (mm)	H (mm)	L (mm)	(g)	(pcs.)	
10	15.8	19	10	200	151	5	*1
12	18.3	19	12	200	159	5	*1

*1 C-Ring=C31, Pin/O-Ring=A31/B31 → P256-257

13146M-150 (mm)	D ₁ (mm)	D ₂ (mm)	H (mm)	L (mm)	(g)	(pcs.)	
8	12	19	6	150	128	5	*1
10	14.3	19	7	150	131	5	*1
12	18	19	8	150	133	5	*1
13	19.3	19	8.5	150	132	5	*1
14	20	19	9	150	132	5	*1

13146M-200 (mm)	D ₁ (mm)	D ₂ (mm)	H (mm)	L (mm)	(g)	(pcs.)	
8	12	19	6	200	159	5	*1
10	14.3	19	7	200	162	5	*1
12	18	19	8	200	164	5	*1
13	19.3	19	8.5	200	163	5	*1
14	20	19	9	200	163	5	*1

13146M-250 (mm)	D ₁ (mm)	D ₂ (mm)	H (mm)	L (mm)	(g)	(pcs.)	
8	12	19	6	250	190	5	*1
10	14.3	19	7	250	193	5	*1
12	18	19	8	250	195	5	*1
13	19.3	19	8.5	250	194	5	*1
14	20	19	9	250	194	5	*1

*1 C-Ring=C31, Pin/O-Ring=A31/B31 → P256-257

13146M-150 / -200 / -250

○ Extra Long Universal Sockets
Schäftsteckschlüssel mit Gelenk
Douilles, articulées, série allongée

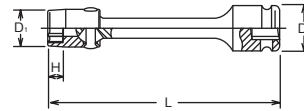

13147M-150 (mm)	D ₁ (mm)	D ₂ (mm)	H (mm)	L (mm)	(g)	(pcs.)	
4	21	19	15	150	125	5	*1
5	21	19	15	150	128	5	*1
6	21	19	15	150	132	5	*1
8	21	19	15	150	136	5	*1
10	21	19	15	150	140	5	*1

13147M-200 (mm)	D ₁ (mm)	D ₂ (mm)	H (mm)	L (mm)	(g)	(pcs.)	
4	21	19	15	200	156	5	*1
5	21	19	15	200	159	5	*1
6	21	19	15	200	163	5	*1
8	21	19	15	200	167	5	*1
10	21	19	15	200	171	5	*1

*1 C-Ring=C31, Pin/O-Ring=A31/B31 → P256-257

13147M-150 / -200

● Extra Long Universal Inhex Sockets
Schäftsteckschlüssel mit Aussensechskant Gelenk
Douilles, articulées, à 6-pans mâle, série allongée

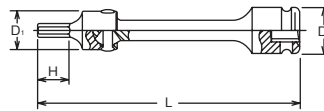

Impact Sockets Impact Steckschlüssel Douilles Impact

3/8"

Z-SERIES
HAND
TITANIUM
SCREWDRIVERS ACCESSORIES
IMPACT
SLEEVE-DRIVE
PROTECTOR
INDUSTRIAL
AUTOMOTIVE
MOTORCYCLE
CONSTRUCTION
SPARE PART

13012M-52

 Inhex Sockets
Steckschlüssel für Innensechskant-Schrauben
Douilles tournevis pour vis 6-pans creux



13012M-52 (mm)	D (mm)	H ₁ (mm)	H ₂ (mm)	L (mm)	(g)	(pcs.)	(V)
3	18	10	34	52	33	10	*1
4	18	15.5	34	52	35	10	*1
5	18	15.5	34	52	35	10	*1
6	18	15.5	34	52	39	10	*1
7	18	15.5	34	52	44	10	*1
8	21	15.5	34	52	60	10	*2
10	21	15.5	34	52	70	10	*2
12	21	15.5	34	52	79	10	*2
14	21	15.5	34	52	92	10	*2

*1 C-Ring=C31, Pin/O-Ring=A31/B31
*2 C-Ring=C32, Pin/O-Ring=A32/B32 [P256-257](#)

RS13012M/8-L52

 Socket Set on Rail
Steckschlüsselsatz auf Schiene
Jeu de douilles sur rail



RS13012M/8-L52	8 Pieces Set/Rail 200mm	(g)
4, 5, 6, 7, 8, 10, 12, 14		492

13025-50 / -90

 TORX® Bit Sockets
TORX® Bit-Steckschlüssel
Douilles tournevis, TORX®



13025-50 (T)	D (mm)	H (mm)	L (mm)	(g)	(pcs.)	(V)
T20	19	23.5	50	35	10	*1
T25	19	23.5	50	35	10	*1
T27	19	23.5	50	35	10	*1
T30	19	23.5	50	35	10	*1
T40	19	23.5	50	39	10	*1
T45	19	23.5	50	60	10	*1
T50	19	23.5	50	70	10	*1
T55	22	23.5	50	79	10	*2

13025-90 (T)	D (mm)	H (mm)	L (mm)	(g)	(pcs.)	(V)
T20	19	63.5	90	43	10	*1
T25	19	63.5	90	45	10	*1
T27	19	63.5	90	47	10	*1
T30	19	63.5	90	50	10	*1
T40	19	63.5	90	58	10	*1
T45	19	63.5	90	66	10	*1
T50	19	63.5	90	80	10	*1
T55	22	63.5	90	120	10	*2

*1 C-Ring=C31, Pin/O-Ring=A31/B31
*2 C-Ring=C32, Pin/O-Ring=A32/B32 [P256-257](#)

RS13025/8-L50

 Socket Set on Rail
Steckschlüsselsatz auf Schiene
Jeu de douilles sur rail



RS13025/8-L50	8 Pieces Set/Rail 200mm	(g)
T20, T25, T27, T30, T40, T45, T50, T55		380

	D ₁ (mm)	D ₂ (mm)	L (mm)	(g)	(pcs.)	
13134	22.5	22	32	70	10	*2

*2 C-Ring=C32, Pin/O-Ring=A32/B32 → P256-257

For DIN3126 E11.2 Bits
Für DIN3126 E11.2 Bits
Pour DIN3126 E11.2 Embouts

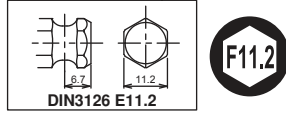

13134 ○ Impact Bit Holder Impact Klingenhälter Porte embouts Impact

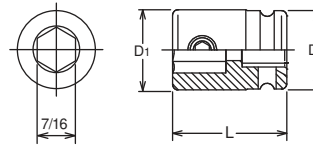

13134-SC

Replacement Screw : M8x5, ● 4mm
Ersatzschraube : M8x5, ● 4mm
Vis de remplacement : M8x5, ● 4mm

	D ₁ (mm)	D ₂ (mm)	L (mm)	(g)	(pcs.)	
13142-F11.2	18.9	22	46	116	10	*2

*2 C-Ring=C32, Pin/O-Ring=A32/B32 → P256-257

For DIN3126 E11.2 Bits
Für DIN3126 E11.2 Bits
Pour DIN3126 E11.2 Embouts

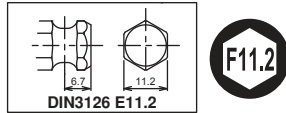

13142-F11.2 ○ Impact Bit Holder (Quick Release) Impact Klingenhälter (Quick Release) Porte embouts Impact (Quick Release) ⚠

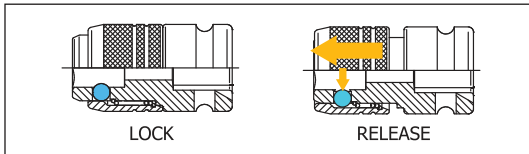
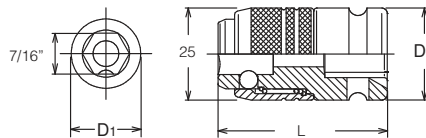

⚠ You may not hold the sliding part while moving to avoid heating up by friction and reduction by wear.

183H-35 (inch)	L (mm)	(g)	(pcs.)
3/16	35	15	10
7/32	35	16	10
1/4	35	18	10
5/16	35	20	10
3/8	35	26	10
7/16	35	28	10
1/2	35	38	10

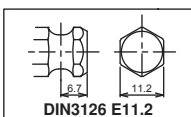

183H-35 / -75 / -150 ● Hex Bits Sechskant Bits Embouts, 6 pans creux

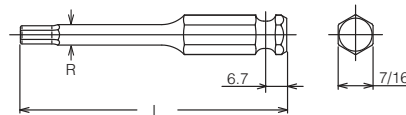

183H-35 (mm)	L (mm)	(g)	(pcs.)
3	35	15	10
4	35	15	10
5	35	15	10
6	35	18	10
7	35	19	10
8	35	20	10
9	35	23	10
10	35	26	10
11	35	28	10
12	35	30	10
14	35	35	10
16	35	47	10
17	35	50	10
18	35	53	10
19	35	56	10

⚠ The items with ⚠ have larger output size than 7/16" input hex drive.
Due to this design the Maximum output torque rating is less than standards.

183H-75 (mm)	L (mm)	R (mm)	(g)	(pcs.)
3	75	6	34	10
4	75	6	35	10
5	75	6.5	36	10
6	75	7.5	39	10
7	75	8.5	44	10
8	75	9.5	47	10
10	75	-	57	10
11	75	-	60	10
12	75	-	65	10
14	75	-	79	10

183H-150 (mm)	L (mm)	R (mm)	(g)	(pcs.)
4	150	6	51	10
5	150	6.5	55	10
6	150	7.5	65	10
8	150	9.5	87	10
10	150	-	118	10
12	150	-	136	10

Z-SERIES
HAND
TITANIUM
SCREWDRIVERS ACCESSORIES
IMPACT
SLEEVE-DRIVE
PROTECTOR
INDUSTRIAL
AUTOMOTIVE
MOTORCYCLE
CONSTRUCTION
SPARE PART

183T-35 / -75 / -150 (T)

TORX® Bits
TORX® Bits
Embouts, TORX®

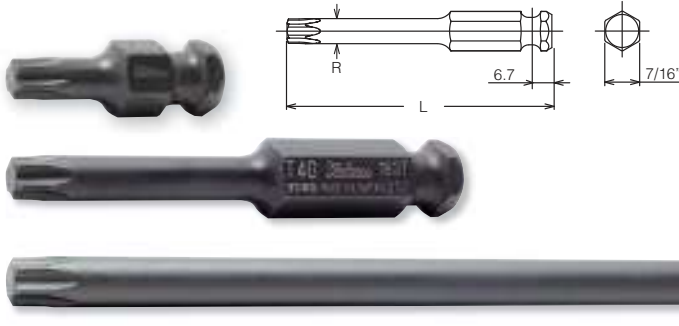

183T-35 (T)	L (mm)	(g)	(pcs.)
T25	35	18	10
T30	35	18	10
T40	35	20	10
T45	35	22	10
T50	35	26	10
T55	35	30	10
T60	35	38	10

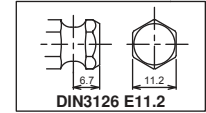

183T-150 (T)	L (mm)	R (mm)	(g)	(pcs.)
T30	150	6	50	10
T40	150	6.9	58	10
T45	150	8	70	10
T50	150	9	82	10
T55	150	11.4	113	10

183T-75 (T)	L (mm)	R (mm)	(g)	(pcs.)
T30	75	6	35	10
T40	75	6.9	37	10
T45	75	8	41	10
T50	75	9	45	10
T55	75	11.4	55	10
T60	75	13.5	67	10

183T-35 / -75 (IP)

TORXPLUS® Bits
TORXPLUS® Bits
Embouts TORXPLUS®

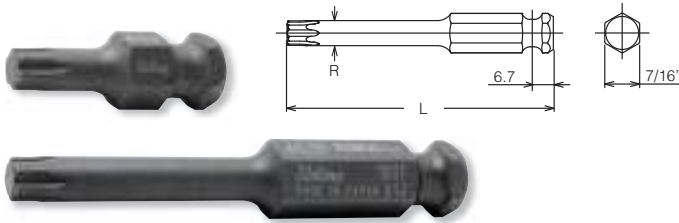

183T-35 (IP)	L (mm)	(g)	(pcs.)
30IP	35	18	10
40IP	35	20	10
45IP	35	22	10
50IP	35	26	10
55IP	35	30	10
60IP	35	38	10

183T-75 (IP)	L (mm)	R (mm)	(g)	(pcs.)
30IP	75	6	35	10
40IP	75	6.8	37	10
45IP	75	8	41	10
50IP	75	9	45	10
55IP	75	11.4	56	10
60IP	75	13.5	67	10

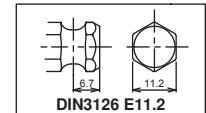

183X-35 / -75 / -150 (XZN)

XZN Bits
XZN Bits
Embouts, XZN

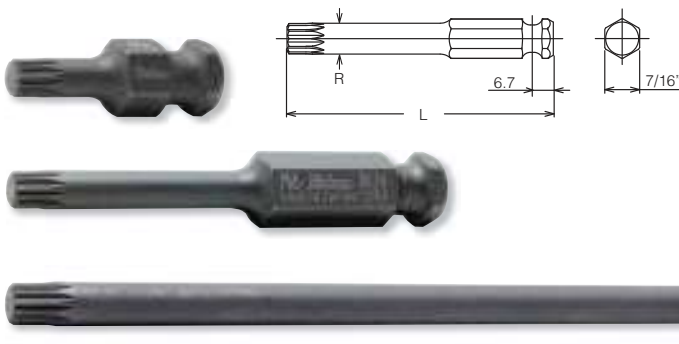

183X-35 (XZN)	L (mm)	(g)	(pcs.)
M 4	35	18	10
M 5	35	18	10
M 6	35	20	10
M 8	35	22	10
M10	35	26	10
M12	35	30	10
M14	35	38	10

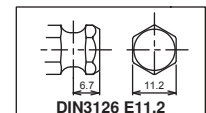

183X-75 (XZN)	L (mm)	R (mm)	(g)	(pcs.)
M 4	75	6	34	10
M 5	75	6	34	10
M 6	75	6.2	36	10
M 8	75	7.4	39	10
M10	75	9.8	54	10
M12	75	11.7	57	10
M14	75	13.5	67	10

183X-150 (XZN)	L (mm)	R (mm)	(g)	(pcs.)
M 5	150	6	50	10
M 6	150	6.2	53	10
M 8	150	7.4	64	10
M10	150	9.8	93	10
M12	150	11.7	121	10

The items with ⚠ have larger output size than 7/16" input hex drive. Due to this design the Maximum output torque rating is less than standards.

13134M-52 (mm)	D (mm)	H (mm)	L (mm)	R (mm)	(g)	(pcs.)	
3	22	20	52	6	85	10	*2
4	22	20	52	6	85	10	*2
5	22	20	52	6.5	85	10	*2
6	22	20	52	7.5	88	10	*2
8	22	20	52	9.5	90	10	*2
10	22	20	52	-	96	10	*2
12	22	20	52	-	100	10	*2
14	22	20	52	-	105	10	*2

13134M-92 (mm)	D (mm)	H (mm)	L (mm)	R (mm)	(g)	(pcs.)	
3	22	60	92	6	104	10	*2
4	22	60	92	6	105	10	*2
5	22	60	92	6.5	106	10	*2
6	22	60	92	7.5	109	10	*2
8	22	60	92	9.5	117	10	*2
10	22	60	92	-	127	10	*2
12	22	60	92	-	135	10	*2
14	22	60	92	-	149	10	*2

*2 C-Ring=C32, Pin/O-Ring=A32/B32 → P256-257

13134T-52 (T)	D (mm)	H (mm)	L (mm)	R (mm)	(g)	(pcs.)	
T30	22	20.6	52	6	88	10	*2
T40	22	20.6	52	6.9	90	10	*2
T45	22	20.6	52	8	92	10	*2
T50	22	20.6	52	9	96	10	*2
T55	22	20.6	52	11.4	100	10	*2
T60	22	20.6	52	13.5	108	10	*2

13134T-92 (T)	D (mm)	H (mm)	L (mm)	R (mm)	(g)	(pcs.)	
T30	22	20.6	92	6	105	10	*2
T40	22	20.6	92	6.9	107	10	*2
T45	22	20.6	92	8	111	10	*2
T50	22	20.6	92	9	115	10	*2
T55	22	20.6	92	11.4	125	10	*2
T60	22	20.6	92	13.5	137	10	*2

*2 C-Ring=C32, Pin/O-Ring=A32/B32 → P256-257

13134T-52 (IP)	D (mm)	H (mm)	L (mm)	R (mm)	(g)	(pcs.)	
30IP	22	20.6	52	6	88	10	*2
40IP	22	20.6	52	6.8	90	10	*2
45IP	22	20.6	52	8	92	10	*2
50IP	22	20.6	52	9	96	10	*2
55IP	22	20.6	52	11.4	100	10	*2
60IP	22	20.6	52	13.5	108	10	*2

13134T-92 (IP)	D (mm)	H (mm)	L (mm)	R (mm)	(g)	(pcs.)	
30IP	22	20.6	92	6	105	10	*2
40IP	22	20.6	92	6.8	107	10	*2
45IP	22	20.6	92	8	111	10	*2
50IP	22	20.6	92	9	115	10	*2
55IP	22	20.6	92	11.4	126	10	*2
60IP	22	20.6	92	13.5	139	10	*2

*2 C-Ring=C32, Pin/O-Ring=A32/B32 → P256-257

13134X-52 (XZN)	D (mm)	H (mm)	L (mm)	R (mm)	(g)	(pcs.)	
M 5	22	20.6	52	6	88	10	*2
M 6	22	20.6	52	6.2	90	10	*2
M 8	22	20.6	52	7.4	92	10	*2
M10	22	20.6	52	9.8	96	10	*2
M12	22	20.6	52	11.7	100	10	*2
M14	22	20.6	52	13.5	108	10	*2

13134X-92 (XZN)	D (mm)	H (mm)	L (mm)	R (mm)	(g)	(pcs.)	
M 5	22	20.6	92	6	104	10	*2
M 6	22	20.6	92	6.2	106	10	*2
M 8	22	20.6	92	7.4	109	10	*2
M10	22	20.6	92	9.8	124	10	*2
M12	22	20.6	92	11.7	129	10	*2
M14	22	20.6	92	13.5	139	10	*2

*2 C-Ring=C32, Pin/O-Ring=A32/B32 → P256-257

⚠ The items with ⚠ have larger output size than 7/16" input hex drive.
Due to this design the Maximum output torque rating is less than standards.

13134M-52 / -92

● Bit Holder complete with Bit, Inhex
Klingenhalter komplett mit Klinge, Innensechskant
Porte embouts avec bit 6-pans creux

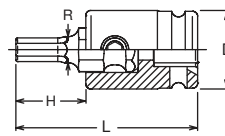

13134T-52 / -92 (T)

● Bit Holder complete with TORX® Bit
Klingenhalter, komplett mit TORX® Klinge
Porte embouts avec bit TORX®

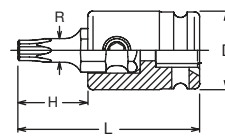

13134T-52 / -92 (IP)

● Bit Holder complete with TORXPLUS® Bit
Klingenhalter, komplett mit TORXPLUS® Klinge
Porte embouts avec bit TORXPLUS®

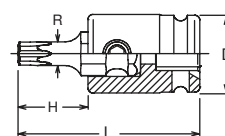

13134X-52 / -92 (XZN)

● Bit Holder complete with XZN Bit
Klingenhalter, komplett mit XZN Klinge
Porte embouts avec bit XZN

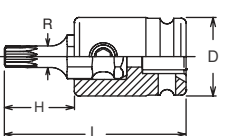

Impact Sockets Impact Steckschlüssel Douilles Impact

3/8"

Z-SERIES

HAND

TITANIUM

SCREWDRIVERS ACCESSORIES

IMPACT

SLEEVE-DRIVE

PROTECTOR

INDUSTRIAL

AUTOMOTIVE

CONSTRUCTION MOTORCYCLE

SPARE PART

13139 ○ Bit Holder Klingenhalter Porte-embout

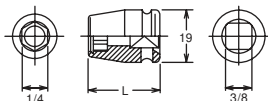

	D ₁ (mm)	D ₂ (mm)	L (mm)	(g)	(pcs.)	⚡
13139-1/4	11	19	30	32	10	*1

*1 C-Ring=C31,Pin/O-Ring=A31/B31 → P256-257

For DIN3126 C6.3 Bits
Für DIN3126 C6.3 Bits
Pour DIN3126 C6.3 Embouts

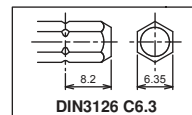

13140 ○ Bit Holder Klingenhalter Porte-embout

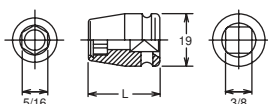

	D ₁ (mm)	D ₂ (mm)	L (mm)	(g)	(pcs.)	⚡
13140-5/16	14	19	30	32	10	*1

*1 C-Ring=C31,Pin/O-Ring=A31/B31 → P256-257

For DIN3126 C8 Bits
Für DIN3126 C8 Bits
Pour DIN3126 C8 Embouts

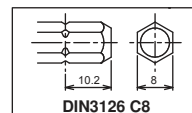

13142-D6.3 ○ Impact Bit Holder (Quick Release) Impact Kingenhalter (Schnellwechselfutter) Porte embout Impact (mandrin autoserrant) ⚠

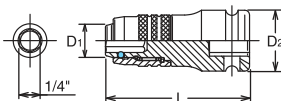

	D ₁ (mm)	D ₂ (mm)	L (mm)	(g)	(pcs.)	⚡
13142-D6.3	16	19	45	60	10	*1

*1 C-Ring=C31,Pin/O-Ring=A31/B31 → P256-257

For DIN3126 C6.3 Bits
Für DIN3126 C6.3 Bits
Pour DIN3126 C6.3 Embouts

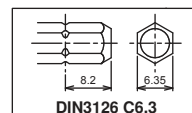

⚠ You may not hold the sliding part while moving to avoid heating up by friction and reduction by wear.

13142-F6.3 ○ Impact Bit Holder (Quick Release) Impact Kingenhalter (Schnellwechselfutter) Porte embout Impact (mandrin autoserrant) ⚠

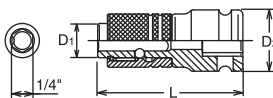

	D ₁ (mm)	D ₂ (mm)	L (mm)	(g)	(pcs.)	⚡
13142-F6.3	16.5	19	45	60	10	*1

*1 C-Ring=C31,Pin/O-Ring=A31/B31 → P256-257

For DIN3126 E6.3 Bits
Für DIN3126 E6.3 Bits
Pour DIN3126 E6.3 Embouts

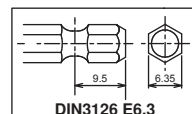

Lock & Quick Release

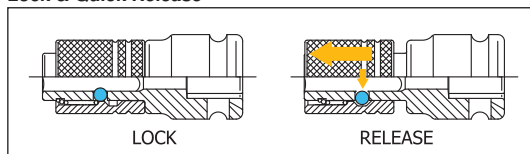

⚠ You may not hold the sliding part while moving to avoid heating up by friction and reduction by wear.

	TYPE	D (mm)	L (mm)	(g)	(pcs.)	
13760-50P	Pin	22	50	70	10	*2
13760-75P	Pin	22	75	95	10	*2
13760-100P	Pin	22	100	115	10	*2
13760-125P	Pin	22	125	140	5	*2
13760-150P	Pin	22	150	165	5	*2
13760-200P	Pin	22	200	215	5	*2
13760-250P	Pin	22	250	260	5	*2

	TYPE	D (mm)	L (mm)	(g)	(pcs.)	
13760-50	Hole	22	50	70	10	*2
13760-75	Hole	22	75	95	10	*2
13760-100	Hole	22	100	115	10	*2
13760-125	Hole	22	125	140	5	*2
13760-150	Hole	22	150	165	5	*2
13760-200	Hole	22	200	215	5	*2
13760-250	Hole	22	250	260	5	*2

*2 C-Ring=C32, Pin/O-Ring=A32/B32 → P256-257



13760-P 13760

Extension Bars
Verlängerungen
Rallonges



	L (mm)	(g)	(pcs.)	
13333AL	45	62	10	*1

*1 C-Ring=C31, Pin/O-Ring=A31/B31 → P256-257

Lock & Quick Release

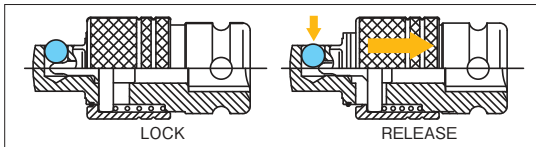

⚠ You may not hold the sliding part while moving to avoid heating up by friction and reduction by wear.



13333AL

Adaptor (Quick Release)
Verbindungsstück (Quick Release) ⚠
Adaptateur (Quick Release)

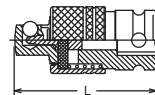

Impact Sockets Impact Steckschlüssel Douilles Impact

3/8"

Z-SERIES
HAND
TITANIUM
SCREWDRIVERS ACCESSORIES
IMPACT
SLEEVE-DRIVE
PROTECTOR
INDUSTRIAL
AUTOMOTIVE
CONSTRUCTION MOTORCYCLE
SPARE PART

13770-P 13770

Universal Joint
Gelenk-Einsatz
Joint articulé

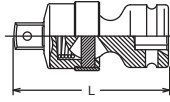
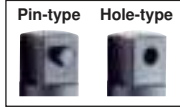

13771-P 13771

Universal Joint
Gelenk-Einsatz
Joint articulé

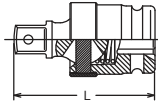

13772-P 13772-B

Universal Double Joint
Doppelgelenk-Einsatz
Joint articulé double



UNIVERSAL
DOUBLE JOINT

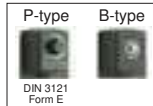

DIN 3121
Form E

13322A-P 13322A

Adaptor
Verbindungsstück
Réducteur

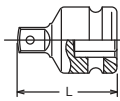

13344A-P 13344A

Adaptor
Verbindungsstück
Augmentateur

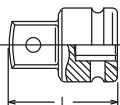

13241M

Socket Set
Steckschlüssel Satz
Jeu de clés à douilles



13242M

Socket Set
Steckschlüssel Satz
Jeu de clés à douilles



	TYPE	L (mm)	(g)	(pcs.)	
13770-P	Pin	56	110	10	*2
13770	Hole	56	110	10	*2
13771-P	Pin	48	92	10	*2
13771	Hole	48	92	10	*2

*2 C-Ring=C32, Pin/O-Ring=A32/B32 → P256-257

Our ball joints are spring-loaded and can therefore be adjusted to an angle of max. 30°.

Unsere Kugelgelenke sind federbelastet dadurch sind sie auf einen Winkel von max 30° einstellbar.

Nos joints à rotule sont à ressort et peuvent donc être réglés jusqu'à un angle de 30° maximum.

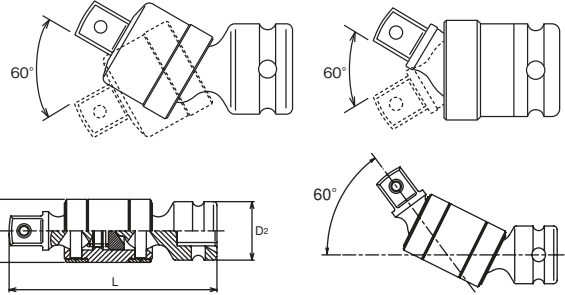

	TYPE	D ₁ (mm)	D ₂ (mm)	L (mm)	(g)	(pcs.)	
13772-P	Pin	22	19	75	120	5	*1
13772-B	Hole	22	19	75	120	5	*1

*1 C-Ring=C31, Pin/O-Ring=A31/B31 → P256-257

Make sure sockets hold bolts or nuts before operation.

Vergewissern Sie sich vor dem Gebrauch, dass der Steckschlüssel die Schraube sicher umfasst hat.

Avant la manipulation, il est nécessaire de s'assurer que la douille renferme parfaitement le vis.

13772 and 14772 have less load capacity than standard. In the interest of your safety always use properly.

	TYPE	(sq.)	(sq.)	L (mm)	(g)	(pcs.)	
13322A-P	Pin	3/8"	1/4"	27	25	10	*1
13322A	Hole	3/8"	1/4"	27	25	10	*1

*1 C-Ring=C31, Pin/O-Ring=A31/B31 → P256-257

Adapting down from bigger square drive to smaller square drive may lead to excessive torque load and possibly cause breakage. Always stay within safe torque of the smaller square drive.

Die mit gekennzeichneten Artikel können bei Überbelastung zu Bruch gehen. Aus Gründen Ihrer eigenen Sicherheit sollten die betreffenden Werkzeuge nie ruckartig, sondern nach und nach belastet werden, um Bruch und damit verbundene mögliche Verletzungen zu vermeiden.

Il est possible d'appliquer aux articles marqués des couples de serrage susceptibles d'occasionner leur rupture. Pour votre propre sécurité, veuillez toujours appliquer la charge d'une manière uniforme et progressive. Ceci pour éviter ruptures et accidents.

	TYPE	(sq.)	(sq.)	L (mm)	(g)	(pcs.)	
13344A-P	Pin	3/8"	1/2"	32.5	53	10	*2
13344A	Hole	3/8"	1/2"	32.5	53	10	*2

*2 C-Ring=C32, Pin/O-Ring=A32/B32 → P256-257

13241M 11 Pieces Set/△=850g

METAL CASE:W240×H30×T35mm

Sockets

13400M 6-pt. Sockets
9, 10, 11, 12, 13, 14, 15, 16, 17, 18, 19

13242M 11 Pieces Set/△=1,140g

METAL CASE:W310×H90×T48mm

Sockets

13400M 6-pt. Sockets
9, 10, 11, 12, 13, 14, 15, 16, 17, 18, 19

1/2"

Impact Sockets
Impact Steckschlüssel
Douilles Impact



FLAT DRIVE®

14400M / 14400A

6-point Sockets
6-kant Steckschlüssel
Douilles 6-pans

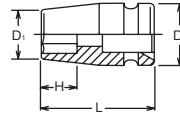

14400M (mm)	D ₁ (mm)	D ₂ (mm)	H (mm)	L (mm)	(g)	(pcs.)	
8	14.5	25	6	38	85	10	*1
9	15.7	25	7	38	85	10	*1
10	17	25	7	38	85	10	*1
11	18.2	25	8	38	85	10	*1
12	19.5	25	9	38	85	10	*1
13	20.7	25	10	38	85	10	*1
14	22	25	10	38	85	10	*1
15	23.2	30	11	38	130	10	*2
16	24.5	30	11	38	130	10	*2
17	25.7	30	12	38	130	10	*2
18	27	30	13	38	130	10	*2
19	28.2	30	13	38	125	10	*2
20	29.5	30	13	38	127	10	*2
21	30.7	30	14	38	120	10	*2
22	32	30	14	38	130	10	*2
23	33.2	30	14	38	130	10	*2
24	34.5	30	14	38	135	10	*2
25	35.7	30	14	38	135	10	*2
26	37	30	14	38	160	10	*2
27	38.2	30	16	40	160	10	*2
28	39.5	30	16	40	170	10	*2
29	40.7	30	17	42	190	10	*2
30	42	30	17	42	190	10	*2
31	43.2	30	17	42	213	10	*2
32	44.5	30	18	42	216	10	*2
33	45.7	30	19	46	260	5	*2
34	47	30	19	46	263	5	*2
35	48.2	30	19	46	275	5	*2
36	49.5	30	20	46	285	5	*2
38	52	30	20	53	360	5	*2
41	55.7	30	21	55	411	2	*2

*1 C-Ring=C41, Pin/O-Ring=A41/B41 → P256-257
*2 C-Ring=C42, Pin/O-Ring=A42/B42

14400A (inch)	D ₁ (mm)	D ₂ (mm)	H (mm)	L (mm)	(g)	(pcs.)	
1/4	12	25	5	38	80	10	*1
5/16	14.5	25	6	38	85	10	*1
3/8	17	25	7	38	85	10	*1
7/16	18.2	25	8	38	85	10	*1
1/2	20.7	25	10	38	85	10	*1
9/16	22	25	10	38	85	10	*1
19/32	23.2	30	11	38	130	10	*2
5/8	24.5	30	11	38	130	10	*2
11/16	25.7	30	12	38	130	10	*2
3/4	28.2	30	13	38	125	10	*2
13/16	30.7	30	14	38	120	10	*2
7/8	32	30	14	38	130	10	*2
15/16	34.5	30	14	38	135	10	*2
1	35.7	30	14	38	135	10	*2
1. 1/16	38.2	30	16	40	160	10	*2
1. 1/8	40.7	30	17	42	190	10	*2
1. 3/16	42	30	17	42	190	10	*2
1. 1/4	44.5	30	18	42	216	10	*2
1. 5/16	45.7	30	19	46	260	5	*2
1. 3/8	47	30	19	46	263	5	*2
1. 1/2	52	30	20	53	365	5	*2

*1 C-Ring=C41, Pin/O-Ring=A41/B41 → P256-257
*2 C-Ring=C42, Pin/O-Ring=A42/B42

14405M / 14405A

12-point Sockets
12-kant Steckschlüssel
Douilles 12-pans

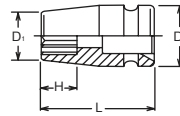

14405M (mm)	D ₁ (mm)	D ₂ (mm)	H (mm)	L (mm)	(g)	(pcs.)	
8	14.5	25	6	38	85	10	*1
9	15.7	25	7	38	85	10	*1
10	17	25	7	38	85	10	*1
11	18.2	25	8	38	84	10	*1
12	19.5	25	9	38	84	10	*1
13	20.7	25	10	38	84	10	*1
14	22	25	10	38	84	10	*1
15	23.2	30	11	38	130	10	*2
16	24.5	30	11	38	127	10	*2
17	25.7	30	12	38	128	10	*2
18	27	30	13	38	130	10	*2
19	28.2	30	13	38	125	10	*2
20	29.5	30	13	38	127	10	*2
21	30.7	30	14	38	120	10	*2
22	32	30	14	38	130	10	*2
23	33.2	30	14	38	132	10	*2
24	34.5	30	14	38	133	10	*2
26	37	30	14	38	147	10	*2
27	38.2	30	16	40	157	10	*2
28	39.5	30	16	40	170	10	*2
30	42	30	17	42	190	10	*2
32	44.5	30	18	42	216	10	*2
36	49.5	30	20	46	285	5	*2
41	55.7	30	21	55	411	2	*2

*1 C-Ring=C41, Pin/O-Ring=A41/B41 → P256-257
*2 C-Ring=C42, Pin/O-Ring=A42/B42

14405A (inch)	D ₁ (mm)	D ₂ (mm)	H (mm)	L (mm)	(g)	(pcs.)	
5/16	14.5	25	6	38	85	10	*1
3/8	17	25	7	38	85	10	*1
7/16	18.2	25	8	38	85	10	*1
1/2	20.7	25	10	38	85	10	*1
9/16	22	25	10	38	85	10	*1
5/8	24.5	30	11	38	130	10	*2
11/16	25.7	30	12	38	130	10	*2
3/4	28.2	30	13	38	125	10	*2
13/16	30.7	30	14	38	120	10	*2
7/8	32	30	14	38	130	10	*2
15/16	34.5	30	14	38	135	10	*2
1	35.7	30	14	38	135	10	*2
1. 1/16	38.2	30	16	40	160	10	*2
1. 1/8	40.7	30	17	42	190	10	*2
1. 3/16	42	30	17	42	190	10	*2
1. 1/4	44.5	30	18	42	216	10	*2
1. 5/16	45.7	30	19	46	260	5	*2
1. 3/8	47	30	19	46	263	5	*2
1. 1/2	52	30	20	53	365	5	*2

*1 C-Ring=C41, Pin/O-Ring=A41/B41 → P256-257
*2 C-Ring=C42, Pin/O-Ring=A42/B42

RS14405M/11	11 Pieces Set/Rail 300mm	(g)
9,10,11,12,13,14,15,16,17,18,19		1,250

RS14405M/11

Socket Set on Rail
Steckschlüsselsatz auf Schiene
Jeu de douilles sur rail



Z-SERIES
HAND
TITANIUM
ACCESSORIES
SCREWDRIVERS
IMPACT
SLEEVE-DRIVE
PROTECTOR
INDUSTRIAL
AUTOMOTIVE
MOTORCYCLE
CONSTRUCTION
SPARE PART

14401M / 14401A

6-point Sockets, Thin Walled
6-kant Steckschlüssel, dünnwandig
Douilles à paroi mince, 6-pans

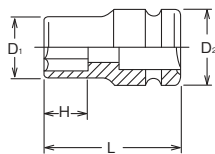

14401A (inch)	D ₁ (mm)	D ₂ (mm)	H (mm)	L (mm)	(g)	(pcs.)	
1/4	10.5	24	5	38	55	10	*1
5/16	13	24	6	38	57	10	*1
3/8	15.5	24	7	38	60	10	*1
7/16	16.7	24	8	38	62	10	*1
1/2	19.2	24	10	38	65	10	*1
9/16	20.5	24	10	38	67	10	*1
5/8	23	29	11	38	102	10	*2
11/16	24.2	29	12	38	105	10	*2
3/4	26.7	29	13	38	107	10	*2
13/16	29.2	29	14	38	109	10	*2
7/8	30.5	29	14	38	114	10	*2
15/16	33	29	14	38	122	10	*2
1	34.2	29	14	38	129	10	*2
1. 1/16	35.5	29	14	40	131	10	*2
1. 1/8	39.2	29	17	42	165	10	*2
1. 3/16	40.5	29	17	42	178	10	*2
1. 1/4	43	29	18	42	188	10	*2
1. 5/16	44.2	29	19	46	219	5	*2
1. 3/8	45.5	29	19	46	248	5	*2

*1 C-Ring=C41, Pin/O-Ring=A41/B41

*2 C-Ring=C42, Pin/O-Ring=A42/B42

→ P256-257

RS14401M/10

Socket Set on Rail
Steckschlüsselsatz auf Schiene
Jeu de douilles sur rail



14401M (mm)	D ₁ (mm)	D ₂ (mm)	H (mm)	L (mm)	(g)	(pcs.)	
8	13	24	6	38	57	10	*1
9	14.2	24	7	38	58	10	*1
10	15.5	24	7	38	60	10	*1
11	16.7	24	8	38	62	10	*1
12	18	24	9	38	63	10	*1
13	19.2	24	10	38	65	10	*1
14	20.5	24	10	38	67	10	*1
15	21.7	29	11	38	100	10	*2
16	23	29	11	38	102	10	*2
17	24.2	29	12	38	105	10	*2
18	25.5	29	13	38	105	10	*2
19	26.7	29	13	38	107	10	*2
20	28	29	13	38	108	10	*2
21	29.2	29	14	38	109	10	*2
22	30.5	29	14	38	114	10	*2
23	31.7	29	14	38	118	10	*2
24	33	29	14	38	122	10	*2
25	34.2	29	14	38	129	10	*2
26	35.5	29	14	38	131	10	*2
27	36.7	29	16	40	145	10	*2
28	38	29	16	40	152	10	*2
29	39.2	29	17	42	165	10	*2
30	40.5	29	17	42	178	10	*2
31	41.7	29	17	42	185	10	*2
32	43	29	18	42	188	10	*2
33	44.2	29	19	46	219	5	*2
34	45.5	29	19	46	248	5	*2
35	46.7	29	19	46	250	5	*2
36	48	29	20	46	264	5	*2
38	50.5	29	20	53	316	5	*2
41	54.2	29	21	55	374	2	*2

*1 C-Ring=C41, Pin/O-Ring=A41/B41

*2 C-Ring=C42, Pin/O-Ring=A42/B42

→ P256-257

RS14401M/10	10 Pieces Set/Rail 300mm	(g)
10, 12, 13, 14, 17, 19, 21, 22, 24, 27		1,010

14406M / 14406A

12-point Sockets, Thin Walled
12-kant Steckschlüssel, dünnwandig
Douilles à paroi mince, 12-pans

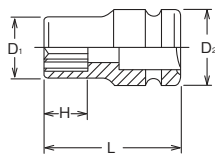

14406A (inch)	D ₁ (mm)	D ₂ (mm)	H (mm)	L (mm)	(g)	(pcs.)	
1/4	10.5	24	5	38	55	10	*1
5/16	13	24	6	38	57	10	*1
3/8	15.5	24	7	38	60	10	*1
7/16	16.7	24	8	38	62	10	*1
1/2	19.2	24	10	38	65	10	*1
9/16	20.5	24	10	38	67	10	*1
5/8	23	29	11	38	102	10	*2
11/16	24.2	29	12	38	105	10	*2
3/4	26.7	29	13	38	107	10	*2
13/16	29.2	29	14	38	109	10	*2
7/8	30.5	29	14	38	114	10	*2
15/16	33	29	14	38	122	10	*2
1	34.2	29	14	38	129	10	*2
1. 1/16	35.5	29	14	40	131	10	*2
1. 1/8	39.2	29	17	42	165	10	*2
1. 3/16	40.5	29	17	42	178	10	*2
1. 1/4	43	29	18	42	188	10	*2
1. 5/16	44.2	29	19	46	219	5	*2
1. 3/8	45.5	29	19	46	248	5	*2

*1 C-Ring=C41, Pin/O-Ring=A41/B41

*2 C-Ring=C42, Pin/O-Ring=A42/B42

→ P256-257

14406M (mm)	D ₁ (mm)	D ₂ (mm)	H (mm)	L (mm)	(g)	(pcs.)	
8	13	24	6	38	57	10	*1
9	14.2	24	7	38	58	10	*1
10	15.5	24	7	38	60	10	*1
11	16.7	24	8	38	62	10	*1
12	18	24	9	38	63	10	*1
13	19.2	24	10	38	65	10	*1
14	20.5	24	10	38	67	10	*1
15	21.7	29	11	38	100	10	*2
16	23	29	11	38	102	10	*2
17	24.2	29	12	38	105	10	*2
18	25.5	29	13	38	105	10	*2
19	26.7	29	13	38	107	10	*2
20	28	29	13	38	108	10	*2
21	29.2	29	14	38	109	10	*2
22	30.5	29	14	38	114	10	*2
23	31.7	29	14	38	118	10	*2
24	33	29	14	38	122	10	*2
25	34.2	29	14	38	129	10	*2
26	35.5	29	14	38	131	10	*2
27	36.7	29	16	40	145	10	*2
28	38	29	16	40	152	10	*2
29	39.2	29	17	42	165	10	*2
30	40.5	29	17	42	178	10	*2
31	41.7	29	17	42	185	10	*2
32	43	29	18	42	188	10	*2
33	44.2	29	19	46	219	5	*2
34	45.5	29	19	46	248	5	*2
36	48	29	20	46	264	5	*2

*1 C-Ring=C41, Pin/O-Ring=A41/B41

*2 C-Ring=C42, Pin/O-Ring=A42/B42

→ P256-257

14401MS (mm)	D ₁ (mm)	D ₂ (mm)	H (mm)	L (mm)	(g)	(pcs.)	
10	15.5	24	4.5	23	41	10	*1
12	18	24	5.5	24	42	10	*1
13	19.2	24	6.5	25	43	10	*1
14	20.5	24	6.5	25	43	10	*1
15	21.7	29	7.5	26	70	10	*2
16	23	29	7.5	26	73	10	*2
17	24.2	29	7.5	26	76	10	*2
18	25.5	29	7.5	26	78	10	*2
19	26.7	29	9.5	28	79	10	*2
21	29.2	29	10	28.5	79	10	*2
22	30.5	29	10	28.5	84	10	*2
24	33	29	10	28.5	87	10	*2
27	36.7	29	10	28.5	100	10	*2

*1 C-Ring=C41, Pin/O-Ring=A41/B41

*2 C-Ring=C42, Pin/O-Ring=A42/B42

→ P256-257

RS14401MS/10	10 Pieces Set/Rail 300mm	(g)
10, 12, 13, 14, 17, 19, 21, 22, 24, 27		740

14400MG (mm)	D ₁ (mm)	D ₂ (mm)	H (mm)	L (mm)	(g)	(pcs.)	
8	14.5	25	3.5	38	95	10	*1
10	17	25	4.2	38	95	10	*1
12	19.5	25	5.6	38	100	10	*1
13	20.7	25	6	38	100	10	*1
14	22	25	6.4	38	105	10	*1
15	23.2	30	6.8	38	140	10	*2
16	24.5	30	7	38	145	10	*2
17	25.7	30	7.5	38	145	10	*2
18	27	30	7.8	38	147	10	*2
19	28.2	30	8	38	147	10	*2
21	30.7	30	8	38	165	10	*2

*1 C-Ring=C41, Pin/O-Ring=A41/B41

*2 C-Ring=C42, Pin/O-Ring=A42/B42

→ P256-257

14401LH (LH-S)	D ₁ (mm)	D ₂ (mm)	H (mm)	L (mm)	(g)	(pcs.)	
6S	13	25	5.6	38	65	10	*1
8S	16.7	25	6.8	38	69	10	*1
10S	19.2	25	8	38	75	10	*1
12S	23	30	9.2	38	115	10	*2
14S	25.5	30	10.4	38	121	10	*2
16S	29.2	30	11.6	38	128	10	*2

*1 C-Ring=C41, Pin/O-Ring=A41/B41

*2 C-Ring=C42, Pin/O-Ring=A42/B42

→ P256-257

14410M (mm)	D ₁ (mm)	D ₂ (mm)	H (mm)	L (mm)	(g)	(pcs.)	
10	17	25	7	38	100	10	*1
11	18.2	25	8	38	103	10	*1
12	19.5	25	9	38	110	10	*1
13	20.7	25	10	38	113	10	*1
14	22	25	10	38	115	10	*1
15	23.2	30	11	38	120	10	*2
16	24.5	30	11	38	120	10	*2
17	25.7	30	12	38	126	10	*2
18	27	30	13	38	121	10	*2
19	28.2	30	13	38	124	10	*2
20	29.5	30	13	38	123	10	*2
21	30.7	30	14	38	120	10	*2
22	32	30	14	38	130	10	*2
23	33.2	30	14	38	130	10	*2
24	34.5	30	14	38	134	10	*2
25	35.7	30	14	38	135	10	*2
26	37	30	14	38	160	10	*2
27	38.2	30	16	40	160	10	*2
28	39.5	30	16	40	170	10	*2
29	40.7	30	17	42	190	10	*2
30	42	30	17	42	190	10	*2
31	43.2	30	17	42	213	10	*2
32	44.5	30	18	42	216	10	*2
34	47	30	19	46	263	5	*2
36	49.5	30	20	46	285	5	*2

*1 C-Ring=C41, Pin/O-Ring=A41/B41

*2 C-Ring=C42, Pin/O-Ring=A42/B42

→ P256-257



SURFACE DRIVE

14401MS

6-point short sockets, Thin Walled
6-kant Steckschlüssel kurz, dünnwandig
Douilles 6-pans courtes, à paroi mince

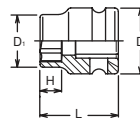

RS14401MS/10

Socket Set on Rail
Steckschlüsselsatz auf Schiene
Jeu de douilles sur rail



14400MG

6-point Sockets with Magnet
6-kant Steckschlüssel mit Magnet
Douilles 6-pans avec aimant

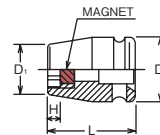

14401LH

LHS Sockets
Steckschlüssel mit LHS Profil
Douilles au profil LHS

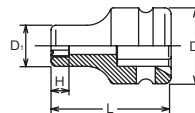

14410M

Surface Drive Sockets
Surface Drive Steckschlüssel
Douilles, Surface Drive

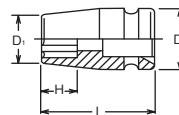

SURFACE DRIVE

Surface drive sockets are designed to retain contact with the flat sides of the nut in order to transmit higher torque and reduce nut wear. These sockets are ideal for using on polished nuts, aluminum nuts and nuts with worn out points.

Das Profil unserer Surface-Drive Steckschlüssel greift die Schraube an deren Flächen. Dies sichert eine höhere Kraftübertragung und verhindert ein Durchrutschen des Steckschlüssels. Diese Steckschlüssel eignen sich besonders für polierte Schrauben, Aluminium Schrauben und Schrauben bei denen die Ecken bereits abgerundet sind.

Notre profil Surface Drive assure le contact entre la douille et les plats de l'écrou. Ceci réduit l'usure et permet la transmission d'un couple plus élevé. C'est une solution idéale pour les écrous polies, celles en aluminium ou arrondies.

Impact Sockets Impact Steckschlüssel Douilles Impact

1/2"

Z-SERIES
HAND
TITANIUM
ACCESSORIES
SCREWDRIVERS
IMPACT
SLEEVE-DRIVE
PROTECTOR
INDUSTRIAL
AUTOMOTIVE
MOTORCYCLE
CONSTRUCTION
SPARE PART

14465M Pathfinder Sockets Pathfinder Steckschlüssel Douilles Pathfinder

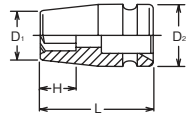

PATHFINDER®

The beveled flats of the 6-points opening of the PATHFINDER socket engage the nut almost immediately. PATHFINDER sockets are ideal for using with power tools in automatic assembly processes, as the power tool does not have to be totally stopped for the socket to engage the nut.

Da die Maschine nicht nach jedem Schraubvorgang angehalten werden muss, ergibt sich eine erhöhte Produktivität, die sich bei vollautomatischen Maschinen (Mehrschraubmaschinen) ganz besonders auswirkt.

Les parois en biais des douilles en 6-pans Pathfinder assurent l'engagement quasi immédiat de l'écrou. Le fait de ne pas devoir arrêter la machine après chaque serrage, engendre une productivité supérieure dans les chaînes de montage automatiques.

14465M (mm)	D ₁ (mm)	D ₂ (mm)	H (mm)	L (mm)	(g)	(pcs.)	
10	17	25	8	38	89	10	*1
11	18.2	25	8	38	87	10	*1
12	19.5	25	9	38	87	10	*1
13	20.7	25	9	38	86	10	*1
14	22	25	11	38	86	10	*1
15	23.2	30	11	38	131	10	*2
16	24.5	30	11	38	131	10	*2
17	25.7	30	12	38	132	10	*2
18	27	30	13	38	128	10	*2
19	28.2	30	13	38	128	10	*2
20	29.5	30	14	38	125	10	*2
21	30.7	30	14	38	128	10	*2
22	32	30	15	38	130	10	*2
23	33.2	30	15	38	135	10	*2
24	34.5	30	15	38	135	10	*2
26	37	30	15	38	152	10	*2
27	38.2	30	16	40	169	10	*2

*1 C-Ring=C41, Pin/O-Ring=A41/B41
*2 C-Ring=C42, Pin/O-Ring=A42/B42 → P256-257

14415M Double 4-point Socket Doppelvierkant Steckschlüssel Douilles 4-pans, doubles

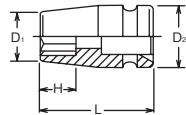

14415M (mm)	D ₁ (mm)	D ₂ (mm)	H (mm)	L (mm)	(g)	(pcs.)	
14	25.7	30	10	38	138	10	*1
15	27	30	11	38	145	10	*1
16	29.5	30	11	38	150	10	*1
17	30.7	30	12	38	155	10	*1
18	32	30	13	38	165	10	*1
19	33.2	30	14	38	170	10	*1
22	38.2	30	14	40	185	10	*1
24	42	30	14	42	215	10	*1
27	45.7	30	16	46	278	5	*1
28	47	30	16	46	285	5	*1
29	49.5	30	17	46	326	5	*2

*1 C-Ring=C41, Pin/O-Ring=A41/B41
*2 C-Ring=C42, Pin/O-Ring=A42/B42 → P256-257

14425 TORX® Sockets TORX® Steckschlüssel Douilles TORX®

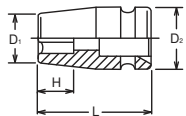

14425 (E)	D ₁ (mm)	D ₂ (mm)	H (mm)	L (mm)	(g)	(pcs.)	
E10	14.2	25	8.2	38	86	10	*1
E11	14.7	25	8.7	38	86	10	*1
E12	15.2	25	9.3	38	85	10	*1
E14	18.2	25	10.6	38	88	10	*1
E16	19.2	25	11.8	38	88	10	*1
E18	22.2	25	13	40	89	10	*1
E20	24.2	30	14.4	40	134	10	*2
E22	26.2	30	15.5	40	140	10	*2
E24	28.2	30	17	42	138	10	*2

*1 C-Ring=C41, Pin/O-Ring=A41/B41
*2 C-Ring=C42, Pin/O-Ring=A42/B42 → P256-257

14425-EPL TORXPLUS® Sockets TORXPLUS® Steckschlüssel Douilles TORXPLUS®

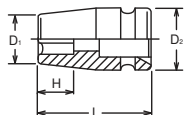

14425 (EPL)	D ₁ (mm)	D ₂ (mm)	H (mm)	L (mm)	(g)	(pcs.)	
10EPL	14.5	25	6.2	38	86	10	*1
12EPL	17	25	7.2	38	86	10	*1
14EPL	18.2	25	8.1	38	88	10	*1
16EPL	20.7	25	9.1	38	88	10	*1
18EPL	22	25	10.2	38	90	10	*1
20EPL	24.5	30	11.2	38	135	10	*2

*1 C-Ring=C41, Pin/O-Ring=A41/B41
*2 C-Ring=C42, Pin/O-Ring=A42/B42 → P256-257

14400-WN Weld Nut Sockets Steckschlüssel für Schweißmutter Douille pour écrou à souder

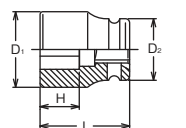

14400-WN	D ₁ (mm)	D ₂ (mm)	H (mm)	L (mm)	(g)	(pcs.)	
8WN	18.3	25	8	38	93	10	*1
9WN	19.5	25	9	38	93	10	*1
10WN	20.8	25	10	38	92	10	*1
12WN	24.5	30	12	38	139	10	*2
14WN	27	30	14	38	136	10	*2
17WN	32	30	17	40	150	10	*2

*1 C-Ring=C41, Pin/O-Ring=A41/B41
*2 C-Ring=C42, Pin/O-Ring=A42/B42 → P256-257

1/2"

Impact Sockets
Impact Steckschlüssel
Douilles Impact

14301X (mm)	D ₁ (mm)	D ₂ (mm)	H ₁ (mm)	H ₂ (mm)	L (mm)	(g)	(pcs.)	
8	13	24	8	42	60	72	10	*1
9	14.2	24	9	42	60	75	10	*1
10	15.5	24	10	42	60	79	10	*1
11	16.7	24	11	42	60	82	10	*1
12	18	24	12	42	60	88	10	*1
13	19.2	24	13	42	60	92	10	*1
14	20.5	24	14	42	60	97	10	*1
15	21.7	29	15	42	60	125	10	*2
16	23	29	16	42	60	135	10	*2
17	24.2	29	17	42	60	142	10	*2
18	25.5	29	18	42	60	148	10	*2
19	26.7	29	19	41	60	151	10	*2
21	29.2	29	21	41	60	170	10	*2
22	30.5	29	22	45	65	187	10	*2
23	31.7	29	23	45	65	192	10	*2
24	33	29	24	45	65	202	10	*2
25	34.2	29	25	44	65	210	10	*2
26	35.5	29	26	44	65	218	10	*2
27	36.7	29	27	44	65	231	10	*2
30	40.5	29	30	44	65	268	10	*2
32	43	29	32	44	65	296	10	*2
33	44.2	29	33	44	65	318	2	*2
34	45.5	29	34	44	65	330	2	*2
36	48	29	36	44	65	350	2	*2

*1 C-Ring=C41, Pin/O-Ring=A41/B41

*2 C-Ring=C42, Pin/O-Ring=A42/B42

→ P256-257

RS14301X/10	10 Pieces Set/Rail 300mm	(g)
10, 12, 13, 14, 17, 19, 21, 22, 24, 27		1,585

14301X



6-point Semi-Deep Socket, Thin Walled
6-kant Steckschlüssel mittel lang, dünnwandig
Douilles à paroi mince semi-longues, 6-pans

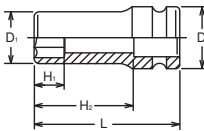

RS14301X/10



Socket Set on Rail
Steckschlüsselsatz auf Schiene
Jeu de douilles sur rail



14300M / 14300A



6-point Deep Sockets
6-kant-Steckschlüssel lang
Douilles longues 6-pans

14300M (mm)	D ₁ (mm)	D ₂ (mm)	H ₁ (mm)	H ₂ (mm)	L (mm)	(g)	(pcs.)	
8	14.5	25	8	62	80	137	10	*1
9	15.7	25	9	62	80	138	10	*1
10	17	25	10	62	80	140	10	*1
11	18.2	25	11	62	80	156	10	*1
12	19.5	25	12	62	80	162	10	*1
13	20.7	25	13	62	80	162	10	*1
14	22	25	14	62	80	174	10	*1
15	23.2	30	15	62	80	220	10	*2
16	24.5	30	16	62	80	232	10	*2
17	25.7	30	17	62	80	232	10	*2
18	27	30	18	62	80	232	10	*2
19	28.2	30	19	61	80	259	10	*2
20	29.5	30	20	61	80	265	10	*2
21	30.7	30	21	61	80	265	10	*2
22	32	30	22	65	85	290	10	*2
23	33.2	30	23	65	85	300	10	*2
24	34.5	30	24	65	85	329	10	*2
25	35.7	30	25	65	85	345	10	*2
26	37	30	26	64	85	350	10	*2
27	38.2	30	27	64	85	385	10	*2
28	39.5	30	28	64	85	390	10	*2
29	40.7	30	29	63	85	416	10	*2
30	42	30	30	63	85	457	10	*2
31	43.2	30	31	63	85	505	10	*2
32	44.5	30	32	63	85	542	10	*2
33	45.7	30	33	62	85	562	2	*2
34	47	30	33	62	85	570	2	*2
35	48.2	30	35	62	85	600	2	*2
36	49.5	30	36	61	85	640	2	*2
38	52	30	38	60	85	655	2	*2
41	55.7	30	38	60	85	690	2	*2

*1 C-Ring=C41, Pin/O-Ring=A41/B41

*2 C-Ring=C42, Pin/O-Ring=A42/B42

→ P256-257

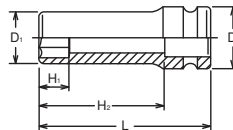

14300A (inch)	D ₁ (mm)	D ₂ (mm)	H ₁ (mm)	H ₂ (mm)	L (mm)	(g)	(pcs.)	
5/16	14.5	25	8	62	80	137	10	*1
3/8	17	25	10	62	80	140	10	*1
7/16	18.2	25	11	62	80	156	10	*1
1/2	20.7	25	13	62	80	162	10	*1
9/16	22	25	14	62	80	174	10	*1
5/8	24.5	30	16	62	80	232	10	*2
11/16	25.7	30	17	62	80	232	10	*2
3/4	28.2	30	19	61	80	259	10	*2
13/16	30.7	30	21	61	80	265	10	*2
7/8	32	30	22	65	85	290	10	*2
15/16	34.5	30	24	65	85	329	10	*2
1	35.7	30	25	65	85	345	10	*2
1. 1/16	38.2	30	27	64	85	385	10	*2
1. 1/8	40.7	30	29	63	85	416	10	*2
1. 3/16	42	30	30	63	85	457	10	*2
1. 1/4	44.5	30	32	63	85	542	10	*2
1. 7/16	50.7	30	37	61	85	580	2	*2
1. 1/2	52	30	38	61	85	600	2	*2

*1 C-Ring=C41, Pin/O-Ring=A41/B41

*2 C-Ring=C42, Pin/O-Ring=A42/B42

→ P256-257

Z-SERIES
HAND
TITANIUM
ACCESSORIES
SCREWDRIVERS
IMPACT
SLEEVE-DRIVE
PROTECTOR
INDUSTRIAL
AUTOMOTIVE
MOTORCYCLE
CONSTRUCTION
SPARE PART

Impact Sockets

Impact Steckschlüssel

Douilles Impact

1/2"

Z-SERIES

HAND

TITANIUM

SCREWDRIVERS ACCESSORIES

IMPACT

SLEEVE-DRIVE

PROTECTOR

INDUSTRIAL

AUTOMOTIVE

MOTORCYCLE

CONSTRUCTION

SPARE PART

14301M / 14301A

6-point Deep Sockets, Thin Walled
6-kant Steckschlüssel, dünnwandig
Douilles à paroi mince longues, 6-pans

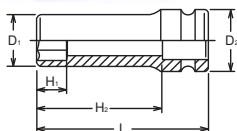

14301A (inch)	D ₁ (mm)	D ₂ (mm)	H ₁ (mm)	H ₂ (mm)	L (mm)	(g)	(pcs.)	
3/8	15.5	24	10	62	80	98	10	*1
7/16	16.7	24	11	62	80	104	10	*1
1/2	19.2	24	13	62	80	120	10	*1
9/16	20.5	24	14	62	80	127	10	*1
5/8	23	29	16	62	80	173	10	*2
11/16	24.2	29	17	62	80	182	10	*2
3/4	26.7	29	19	61	80	197	10	*2
13/16	29.2	29	21	61	80	218	10	*2
7/8	30.5	29	22	65	85	244	10	*2
15/16	33	29	24	65	85	261	10	*2
1. 1/16	36.7	29	27	64	85	314	10	*2
1. 1/8	39.2	29	29	63	85	349	10	*2

*1 C-Ring=C41, Pin/O-Ring=A41/B41
*2 C-Ring=C42, Pin/O-Ring=A42/B42

→ P256-257

14305M

12-point Deep Sockets
12-kant Steckschlüssel, lang
Douilles longues 12-pans

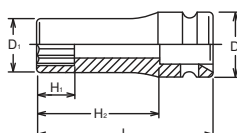

14306M

12-point Deep Sockets, Thin Walled
12-kant Steckschlüssel, dünnwandig
Douilles à paroi mince longues, 12-pans

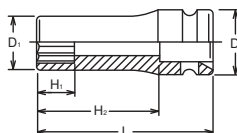

14301M (mm)	D ₁ (mm)	D ₂ (mm)	H ₁ (mm)	H ₂ (mm)	L (mm)	(g)	(pcs.)	
8	13	24	8	62	80	87	10	*1
9	14.2	24	9	62	80	92	10	*1
10	15.5	24	10	62	80	98	10	*1
11	16.7	24	11	62	80	104	10	*1
12	18	24	12	62	80	111	10	*1
13	19.2	24	13	62	80	120	10	*1
14	20.5	24	14	62	80	127	10	*1
15	21.7	29	15	62	80	169	10	*2
16	23	29	16	62	80	173	10	*2
17	24.2	29	17	62	80	182	10	*2
18	25.5	29	18	62	80	192	10	*2
19	26.7	29	19	61	80	197	10	*2
20	28	29	20	61	80	203	10	*2
21	29.2	29	21	61	80	218	10	*2
22	30.5	29	22	65	85	244	10	*2
23	31.7	29	23	65	85	253	10	*2
24	33	29	24	65	85	261	10	*2
25	34.2	29	25	65	85	282	10	*2
26	35.5	29	26	64	85	299	10	*2
27	36.7	29	27	64	85	314	10	*2
28	38	29	29	64	85	273	10	*2
29	39.2	29	29	63	85	280	10	*2
30	40.5	29	30	63	85	360	10	*2
31	41.7	29	31	63	85	370	10	*2
32	43	29	32	63	85	380	10	*2
34	45.5	29	34	62	85	411	2	*2
35	46.7	29	35	62	85	450	2	*2
36	48	29	36	61	85	460	2	*2
38	50.5	29	38	61	85	508	2	*2
41	54.2	29	38	60	85	552	2	*2

*1 C-Ring=C41, Pin/O-Ring=A41/B41

*2 C-Ring=C42, Pin/O-Ring=A42/B42

→ P256-257

14305M (mm)	D ₁ (mm)	D ₂ (mm)	H ₁ (mm)	H ₂ (mm)	L (mm)	(g)	(pcs.)	
8	14.5	25	8	62	80	137	10	*1
10	17	25	10	62	80	140	10	*1
11	18.2	25	11	62	80	156	10	*1
12	19.5	25	12	62	80	162	10	*1
13	20.7	25	13	62	80	162	10	*1
14	22	25	14	62	80	174	10	*1
15	23.2	30	15	62	80	220	10	*2
16	24.5	30	16	62	80	232	10	*2
17	25.7	30	17	62	80	232	10	*2
18	27	30	18	62	80	232	10	*2
19	28.2	30	19	61	80	259	10	*2
20	29.5	30	20	61	80	265	10	*2
21	30.7	30	21	61	80	265	10	*2
22	32	30	22	65	85	290	10	*2
23	33.2	30	23	65	85	300	10	*2
24	34.5	30	24	65	85	329	10	*2
26	37	30	26	64	85	350	10	*2
27	38.2	30	27	64	85	385	10	*2
28	39.5	30	28	64	85	390	10	*2
29	40.7	30	29	63	85	416	10	*2
30	42	30	30	63	85	457	10	*2
32	44.5	30	32	63	85	542	10	*2
33	45.7	30	33	62	85	562	2	*2
36	49.5	30	36	61	85	635	2	*2

*1 C-Ring=C41, Pin/O-Ring=A41/B41

*2 C-Ring=C42, Pin/O-Ring=A42/B42

→ P256-257

14306M (mm)	D ₁ (mm)	D ₂ (mm)	H ₁ (mm)	H ₂ (mm)	L (mm)	(g)	(pcs.)	
8	13	24	8	62	80	88	10	*1
10	15.5	24	10	62	80	98	10	*1
11	16.7	24	11	62	80	104	10	*1
12	18	24	12	62	80	111	10	*1
13	19.2	24	13	62	80	120	10	*1
14	20.5	24	14	62	80	127	10	*1
15	21.7	29	15	62	80	169	10	*2
16	23	29	16	62	80	173	10	*2
17	24.2	29	17	62	80	182	10	*2
18	25.5	29	18	62	80	192	10	*2
19	26.7	29	19	61	80	197	10	*2
21	29.2	29	21	61	80	218	10	*2
22	30.5	29	22	65	85	244	10	*2
24	33	29	24	65	85	261	10	*2
26	35.5	29	26	64	85	299	10	*2
27	36.7	29	27	64	85	314	10	*2
30	40.5	29	30	63	85	360	10	*2
32	43	29	32	63	85	380	10	*2

*1 C-Ring=C41, Pin/O-Ring=A41/B41

*2 C-Ring=C42, Pin/O-Ring=A42/B42

→ P256-257

14310M (mm)	D ₁ (mm)	D ₂ (mm)	H ₁ (mm)	H ₂ (mm)	L (mm)	(g)	(pcs.)	
10	17	25	10	62	80	136	10	*1
11	18.2	25	11	62	80	148	10	*1
12	19.5	25	12	62	80	156	10	*1
13	20.7	25	13	62	80	158	10	*1
14	22	25	14	62	80	170	10	*1
15	23.2	30	15	62	80	225	10	*2
16	24.5	30	16	62	80	228	10	*2
17	25.7	30	17	62	80	232	10	*2
18	27	30	18	62	80	232	10	*2
19	28.2	30	19	61	80	252	10	*2
20	29.5	30	20	61	80	260	10	*2
21	30.7	30	21	61	80	260	10	*2
22	32	30	22	65	85	290	10	*2
23	33.2	30	23	65	85	300	10	*2
24	34.5	30	24	65	85	322	10	*2
25	35.7	30	25	65	85	338	10	*2
26	37	30	26	64	85	350	10	*2
27	38.2	30	27	64	85	380	10	*2
28	39.5	30	28	64	85	390	10	*2
29	40.7	30	29	63	85	416	10	*2
30	42	30	30	63	85	450	10	*2
31	43.2	30	31	63	85	505	10	*2
32	44.5	30	32	63	85	535	10	*2
34	47	30	34	62	85	563	2	*2
36	49.5	30	36	61	85	630	2	*2

*1 C-Ring=C41, Pin/O-Ring=A41/B41 → P256-257
*2 C-Ring=C42, Pin/O-Ring=A42/B42

14300G (mm)	D ₁ (mm)	D ₂ (mm)	H ₁ (mm)	H ₂ (mm)	L (mm)	(g)	(pcs.)	
10	17	25	4.5	26	80	139	10	*1
12	19.5	25	6	26	80	165	10	*1
13	20.7	25	6.5	25	80	185	10	*1
14	22	25	7	24	80	189	10	*1
15	23.2	30	7	24	80	240	10	*2
16	24.5	30	7.5	26.5	80	270	10	*2
17	25.7	30	8	26.5	80	272	10	*2
18	27	30	8.5	26.5	80	290	10	*2
19	28.2	30	9	27.5	80	308	10	*2

*1 C-Ring=C41, Pin/O-Ring=A41/B41 → P256-257
*2 C-Ring=C42, Pin/O-Ring=A42/B42

14365M (mm)	D ₁ (mm)	D ₂ (mm)	H ₁ (mm)	H ₂ (mm)	L (mm)	(g)	(pcs.)	
10	17	25	8	62	80	138	10	*1
11	18.2	25	8	62	80	144	10	*1
12	19.5	25	9	62	80	165	10	*1
13	20.7	25	9	62	80	170	10	*1
14	22	25	11	62	80	178	10	*1
15	23.2	30	11	62	80	237	10	*2
16	24.5	30	11	62	80	245	10	*2
17	25.7	30	12	62	80	263	10	*2
18	27	30	13	62	80	268	10	*2
19	28.2	30	13	61	80	270	10	*2
20	29.5	30	14	61	80	274	10	*2
21	30.7	30	14	61	80	287	10	*2
22	32	30	15	65	85	314	10	*2
23	33.2	30	15	65	85	320	10	*2
24	34.5	30	15	65	85	335	10	*2
26	37	30	15	64	85	388	10	*2
27	38.2	30	16	64	85	407	10	*2

*1 C-Ring=C41, Pin/O-Ring=A41/B41 → P256-257
*2 C-Ring=C42, Pin/O-Ring=A42/B42

14325 (E)	D ₁ (mm)	D ₂ (mm)	H ₁ (mm)	H ₂ (mm)	L (mm)	(g)	(pcs.)	
E10	14.2	25	8.2	62	80	136	10	*1
E12	15.2	25	9.3	62	80	141	10	*1
E14	18.2	25	10.6	62	80	147	10	*1
E16	19.2	25	11.8	62	80	151	10	*1
E18	22.2	25	13	62	80	218	10	*1
E20	24.2	30	14.4	62	80	225	10	*2

*1 C-Ring=C41, Pin/O-Ring=A41/B41 → P256-257
*2 C-Ring=C42, Pin/O-Ring=A42/B42



14310M ○ Surface Drive Sockets, deep
Surface Drive Steckschlüssel, lang
Douilles longues, Surface Drive

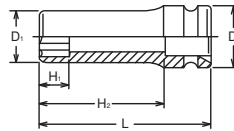

14300G ○ Impact Socket with Sliding Magnet
Impact Steckschlüssel mit versenkbarem Magnet
Douilles Impact avec aimant, glissant pour écrous

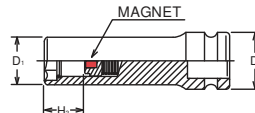
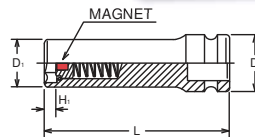

14365M ○ Pathfinder Sockets, deep
Pathfinder Steckschlüssel, lang
Douilles longues, Pathfinder

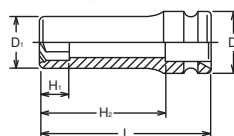

14325 ○ TORX® Deep Sockets
TORX® Steckschlüssel, lang
Douilles longues TORX®

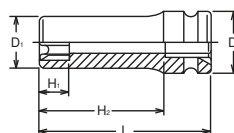

Impact Sockets Impact Steckschlüssel Douilles Impact

1/2"

Z-SERIES
HAND
TITANIUM
SCREWDRIVERS ACCESSORIES
IMPACT
SLEEVE-DRIVE
PROTECTOR
INDUSTRIAL
AUTOMOTIVE
MOTORCYCLE
CONSTRUCTION
SPARE PART

14440M / 14440A

Universal Sockets
Gelenk-Einsätze
Douilles universelles

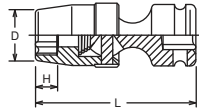

14100M / 14100A

Impact Stud Pullers
Impact Stehbolzenendreher
Extracteurs de goujons Impact

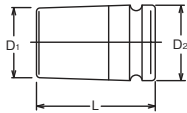

Hexagon body design can lessen the excessive load on cages and rollers inside the pullers.

Der neue Körper mit sechs Walzenmulden verteilt den Druck auf den Käfig und die Walzen weitaus vorteilhafter.

La forme hexagonale du corps améliore les tolérances. Elle répartit l'effort de façon plus uniforme sur la cage et les rouleaux.

14103M

Impact Stud Bolt Setters
Impact Stehbolzensetzer
Monte-goujons Impact

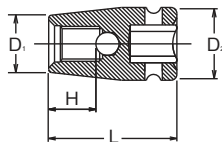

A special socket for installing a stud bolt. Inside steel ball prevent the stud bolt stuck onto the socket. After installing a stud bolt, turn to anti-clockwise to removing the socket.

Spezialwerkzeug zum Setzen von Stehbolzen. Der Bolzen trifft im Werkzeug nur auf die gehärtete Stahlkugel, was die Kontaktfläche verringert. Nach dem Setzen des Stehbolzens kann das Werkzeug im Linkslauf vom Stehbolzen abgezogen werden.

Douilles spéciales pour monter les goujons. Le goujon est en contact avec une bille d'acier pour l'empêcher d'adhérer à la douille. Après avoir posé le goujon, tourner dans le sens antihorlogique pour le retirer

14440M (mm)	D (mm)	H (mm)	L (mm)	(g)	(pcs.)	
13	20.7	6	67.5	210	10	*2
14	22	7	69.5	210	10	*2
15	23.2	7	69.5	210	10	*2
16	24.5	8	69.5	206	10	*2
17	25.7	8	69.5	220	10	*2
18	27	9	69.5	218	10	*2
19	28.2	10	73.5	260	10	*2
20	29.5	10	73.5	270	10	*2
21	30.7	11	73.5	280	10	*2
22	32	13	73.5	290	10	*2
24	34.5	14	73.5	300	10	*2

14440A (inch)	D (mm)	H (mm)	L (mm)	(g)	(pcs.)	
1/2	20.7	6	67.5	210	10	*2
9/16	22	7	69.5	210	10	*2
5/8	24.5	8	69.5	206	10	*2
11/16	25.7	8	69.5	220	10	*2
3/4	28.2	10	73.5	260	10	*2

*2 C-Ring=C42, Pin/O-Ring=A42/B42 → P256-257

14100M (mm)	D1 (mm)	D2 (mm)	L (mm)	(g)	(pcs.)	
6	24	25	48	126	10	*1
7	24	25	48	126	10	*1
8	24	25	48	122	10	*1
9	28	30	48	181	10	*2
10	28	30	48	181	10	*2
12	28	30	48	175	10	*2

14100A (inch)	D1 (mm)	D2 (mm)	L (mm)	(g)	(pcs.)	
1/4	24	25	48	126	10	*1
5/16	24	25	48	122	10	*1
3/8	28	30	48	181	10	*2
7/16	28	30	48	181	10	*2
1/2	28	30	48	180	10	*2

*1 C-Ring=C41, Pin/O-Ring=A41/B41
*2 C-Ring=C42, Pin/O-Ring=A42/B42 → P256-257

Tolerance

14100M (mm)	14100A (inch)
6	5.6- 6
7	6.6- 7
8	7.6- 8
9	8.4- 9
10	9.4-10
12	11.4-12

14103M (mm)	D1 (mm)	D2 (mm)	H (mm)	L (mm)	(g)	(pcs.)	
6(1.0)	12	25	10	42	75	10	*1
7(1.0)	13.2	25	11.4	42	78	10	*1
8(1.25)	14.5	25	11.5	42	81	10	*1
10(1.25)	17	25	13.5	49	106	10	*1
10(1.5)	17	25	13.5	49	106	10	*1
12(1.25)	19.5	25	15.5	49	107	10	*1
12(1.75)	19.5	25	15.5	49	107	10	*1
14(1.5)	22	25	18.2	55	128	10	*1
14(2.0)	22	25	18.2	55	128	10	*1

*1 C-Ring=C41, Pin/O-Ring=A41/B41 → P256-257

⚠ Depend on the stud bolt and using torque, 4103M/13103M/14103M may cause a scratch against the stud bolts or got stuck itself during a work.

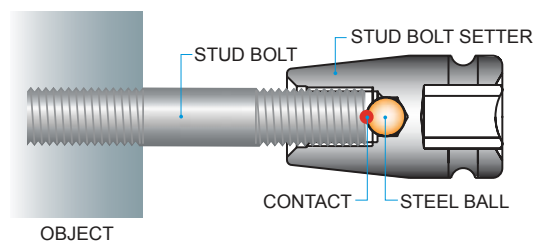

14145M-100 (mm)	D ₁ (mm)	D ₂ (mm)	H (mm)	L (mm)	(g)	(pce.)	
10	17	25	10	100	155	1	*1
12	19.5	25	12	100	165	1	*1
14	22	25	14	100	180	1	*1
17	25.7	25	17	100	210	1	*1
19	28.2	25	19	100	230	1	*1

14145M-150 (mm)	D ₁ (mm)	D ₂ (mm)	H (mm)	L (mm)	(g)	(pce.)	
10	17	25	10	150	190	1	*1
12	19.5	25	12	150	204	1	*1
13	20.7	25	13	150	216	1	*1
14	22	25	14	150	228	1	*1
15	23.2	25	15	150	240	1	*1
16	24.5	25	16	150	245	1	*1
17	25.7	25	17	150	253	1	*1
18	27	25	18	150	260	1	*1
19	28.2	25	19	150	267	1	*1

14145M-200 (mm)	D ₁ (mm)	D ₂ (mm)	H (mm)	L (mm)	(g)	(pce.)	
10	17	25	10	200	234	1	*1
12	19.5	25	12	200	248	1	*1
13	20.7	25	13	200	260	1	*1
14	22	25	14	200	272	1	*1
15	23.2	25	15	200	284	1	*1
16	24.5	25	16	200	290	1	*1
17	25.7	25	17	200	297	1	*1
18	27	25	18	200	305	1	*1
19	28.2	25	19	200	311	1	*1

14145M-250 (mm)	D ₁ (mm)	D ₂ (mm)	H (mm)	L (mm)	(g)	(pce.)	
10	17	25	10	250	278	1	*1
12	19.5	25	12	250	292	1	*1
13	20.7	25	13	250	304	1	*1
14	22	25	14	250	316	1	*1
15	23.2	25	15	250	328	1	*1
16	24.5	25	16	250	335	1	*1
17	25.7	25	17	250	341	1	*1
18	27	25	18	250	350	1	*1
19	28.2	25	19	250	355	1	*1

*1 C-Ring=41C, Pin/O-Ring=A41/B41 → P256-257

14145M-100 / -150 / -200 / -250

○ Extra Long Sockets
Schäftsteckschlüssel
Douilles, série allongée

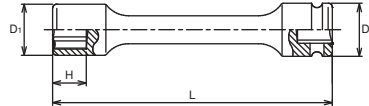

Impact Sockets Impact Steckschlüssel Douilles Impact

1/2"

Z-SERIES
HAND
TITANIUM
ACCESSORIES
IMPACT
SLEEVE-DRIVE
PROTECTOR
INDUSTRIAL
AUTOMOTIVE
MOTORCYCLE
CONSTRUCTION
MOTORCYCLE
SPARE PART

14146M-150 / -200 / -250

○ Extra Long Universal Sockets
Schafsteckschlüssel mit Gelenk
Douilles, articulées, série allongée

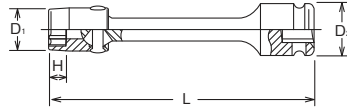

14146M-150 (mm)	D ₁ (mm)	D ₂ (mm)	H (mm)	L (mm)	(g)	(pce.)	Ⓢ
10	16	25	6.5	150	197	1	*1
12	19.3	25	7.5	150	200	1	*1
13	20	25	8	150	201	1	*1
14	21	25	8.5	150	203	1	*1
15	22	25	9	150	201	1	*1
16	23	25	9.5	150	200	1	*1
17	25	25	9.5	150	200	1	*1
18	26	25	11	150	210	1	*1
19	28	25	11.5	150	210	1	*1

14146M-200 (mm)	D ₁ (mm)	D ₂ (mm)	H (mm)	L (mm)	(g)	(pce.)	Ⓢ
10	16	25	6.5	200	241	1	*1
12	19.3	25	7.5	200	244	1	*1
13	20	25	8	200	245	1	*1
14	21	25	8.5	200	247	1	*1
15	22	25	9	200	245	1	*1
16	23	25	9.5	200	244	1	*1
17	25	25	9.5	200	244	1	*1
18	26	25	11	200	250	1	*1
19	28	25	11.5	200	254	1	*1

14146M-250 (mm)	D ₁ (mm)	D ₂ (mm)	H (mm)	L (mm)	(g)	(pce.)	Ⓢ
10	16	25	6.5	250	285	1	*1
12	19.3	25	7.5	250	288	1	*1
13	20	25	8	250	289	1	*1
14	21	25	8.5	250	291	1	*1
15	22	25	9	250	289	1	*1
16	23	25	9.5	250	288	1	*1
17	25	25	9.5	250	288	1	*1
18	26	25	11	250	290	1	*1
19	28	25	11.5	250	299	1	*1

*1 C-Ring=C41, Pin/O-Ring=A41/B41 → P256-257

14147M-150 / -200

⊙ Extra Long Universal Inhex Sockets
Schafsteckschlüssel mit Aussensechskant Gelenk
Douilles, articulées, à 6-pans mâle, série allongée

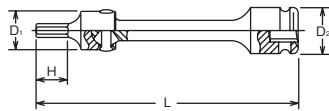

14147M-150 (mm)	D ₁ (mm)	D ₂ (mm)	H (mm)	L (mm)	(g)	(pce.)	Ⓢ
6	25	25	15	150	200	1	*1
8	25	25	15	150	205	1	*1
10	25	25	15	150	210	1	*1
12	25	25	15	150	217	1	*1

14147M-200 (mm)	D ₁ (mm)	D ₂ (mm)	H (mm)	L (mm)	(g)	(pce.)	Ⓢ
6	25	25	15	200	244	1	*1
8	25	25	15	200	249	1	*1
10	25	25	15	200	254	1	*1
12	25	25	15	200	261	1	*1

*1 C-Ring=C41, Pin/O-Ring=A41/B41 → P256-257

14012M-60 (mm)	D (mm)	H ₁ (mm)	H ₂ (mm)	L (mm)	(g)	(pcs.)	⚡
4	25	15.5	38	60	68	10	*1
5	25	15.5	38	60	71	10	*1
6	25	15.5	38	60	74	10	*1
7	25	15.5	38	60	80	10	*1
8	25	15.5	38	60	84	10	*1
10	30	15.5	38	60	140	10	*2
12	30	15.5	38	60	150	10	*2
14	30	15.5	38	60	170	10	*2
16	30	15.5	38	60	180	10	*2
17	30	15.5	38	60	190	10	*2
18	30	15.5	38	60	200	10	*2
19	30	15.5	38	60	210	10	*2

*1 C-Ring=C41, Pin/O-Ring=A41/B41
*2 C-Ring=C42, Pin/O-Ring=A42/B42

→ P256-257

RS14012M/10-L60	10 Pieces Set/Rail 300mm	(g)
4, 5, 6, 7, 8, 10, 12, 14, 17, 19		1,300

14012M-60

Inhex Sockets
Steckschlüssel für Innensechskant-Schrauben
Douilles tournevis pour vis 6-pans creux

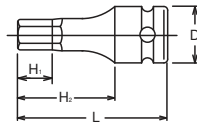

RS14012M/10-L60

Socket Set on Rail
Steckschlüsselsatz auf Schiene
Jeu de douilles sur rail



14025-60 (T)	D (mm)	H (mm)	L (mm)	(g)	(pcs.)	⚡
T20	25	23.5	60	75	10	*1
T25	25	23.5	60	75	10	*1
T27	25	23.5	60	75	10	*1
T30	25	23.5	60	80	10	*1
T40	25	23.5	60	85	10	*1
T45	25	23.5	60	85	10	*1
T50	25	23.5	60	95	10	*1
T55	25	23.5	60	110	10	*1
T60	30	23.5	60	160	10	*2

14025-100 (T)	D (mm)	H (mm)	L (mm)	(g)	(pcs.)	⚡
T30	25	73.5	100	85	10	*1
T40	25	73.5	100	95	10	*1
T45	25	73.5	100	102	10	*1
T50	25	73.5	100	120	10	*1
T55	25	73.5	100	155	10	*1
T60	30	73.5	100	220	10	*2

*1 C-Ring=C41, Pin/O-Ring=A41/B41
*2 C-Ring=C42, Pin/O-Ring=A42/B42

→ P256-257

14025-60 / -100

TORX® Bit Sockets
TORX® Bit-Steckschlüssel
Douilles tournevis, TORX®

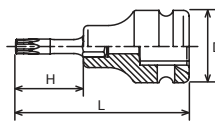

RS14025/6-L60	6 Pieces Set/Rail 200mm	(g)
T30, T40, T45, T50, T55, T60		650

RS14025/6-L60

Socket Set on Rail
Steckschlüsselsatz auf Schiene
Jeu de douilles sur rail



Impact Sockets Impact Steckschlüssel Douilles Impact

1/2"

Z-SERIES

HAND

TITANIUM

SCREWDRIVERS ACCESSORIES

IMPACT

SLEEVE-DRIVE

PROTECTOR

INDUSTRIAL

AUTOMOTIVE

CONSTRUCTION MOTORCYCLE

SPARE PART

14134 ○ Impact Bit Holder Impact Klingenhalter Porte embouts Impact

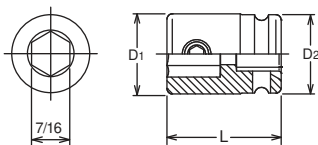

	D ₁ (mm)	D ₂ (mm)	L (mm)	(g)	(pcs.)	⚡
14134	22.5	25	38	90	10	*1

*1 C-Ring=C41, Pin/O-Ring=A41/B41 → P256-257

For DIN3126 E11.2 Bits
Für DIN3126 E11.2 Bits
Pour DIN3126 E11.2 Embouts

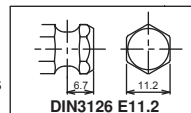

13134-SC



Replacement Screw : M8x5, ● 4mm
Ersatzschraube : M8x5, ● 4mm
Vis de remplacement : M8x5, ● 4mm

14142-F11.2 ○ Impact Bit Holder (Quick Release) Impact Klingenhalter (Quick Release) Porte embouts Impact (Quick Release) ⚠

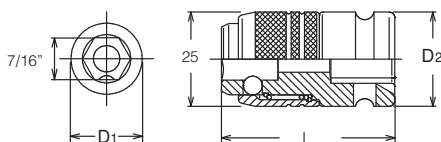

	D ₁ (mm)	D ₂ (mm)	L (mm)	(g)	(pcs.)	⚡
14142-F11.2	18.9	25	46	207	10	*1

*1 C-Ring=C41, Pin/O-Ring=A41/B41 → P256-257

For DIN3126 E11.2 Bits
Für DIN3126 E11.2 Bits
Pour DIN3126 E11.2 Embouts

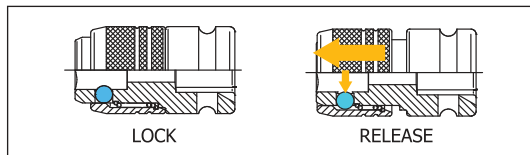
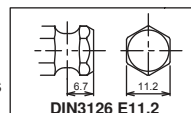

⚠ You may not hold the sliding part while moving to avoid heating up by friction and reduction by wear.

183H-35 / -75 / -150 ● Hex Bits Sechskant Bits Embouts, 6 pans creus

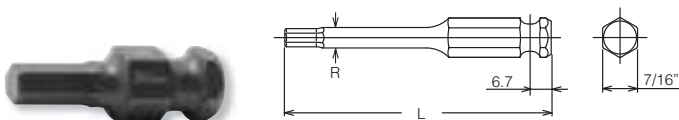

183H-35 (inch)	L (mm)	(g)	(pcs.)
3/16	35	15	10
7/32	35	16	10
1/4	35	18	10
5/16	35	20	10
3/8	35	26	10
7/16	35	28	10
1/2	35	38	10

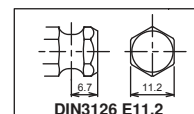

183H-35 (mm)	L (mm)	(g)	(pcs.)
3	35	15	10
4	35	15	10
5	35	15	10
6	35	18	10
7	35	19	10
8	35	20	10
9	35	23	10
10	35	26	10
11	35	28	10
12	35	30	10
14	35	35	10
16	35	47	10
17	35	50	10
18	35	53	10
19	35	56	10



183H-75 (mm)	L (mm)	R (mm)	(g)	(pcs.)
3	75	6	34	10
4	75	6	35	10
5	75	6.5	36	10
6	75	7.5	39	10
7	75	8.5	44	10
8	75	9.5	47	10
10	75	-	57	10
11	75	-	60	10
12	75	-	65	10
14	75	-	79	10



183H-150 (mm)	L (mm)	R (mm)	(g)	(pcs.)
4	150	6	51	10
5	150	6.5	55	10
6	150	7.5	65	10
8	150	9.5	87	10
10	150	-	118	10
12	150	-	136	10



⚠ The items with ⚠ have larger output size than 7/16" input hex drive.
Due to this design the Maximum output torque rating is less than standards.

1/2"

Impact Sockets
Impact Steckschlüssel
Douilles Impact

Z-SERIES
HAND
TITANIUM
ACCESSORIES
SCREWDRIVERS
IMPACT
SLEEVE-DRIVE
PROTECTOR
INDUSTRIAL
AUTOMOTIVE
MOTORCYCLE
CONSTRUCTION
SPARE PART

183T-35 (T)	L (mm)	(g)	(pcs.)
T25	35	18	10
T30	35	18	10
T40	35	20	10
T45	35	22	10
T50	35	26	10
T55	35	30	10
T60	35	38	10

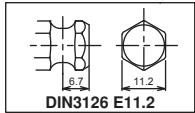

183T-35 / -75 / -150 (T)

TORX® Bits
TORX® Bits
Embout, TORX®

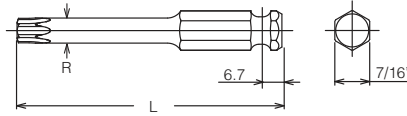

183T-75 (T)	L (mm)	R (mm)	(g)	(pcs.)
T30	75	6	35	10
T40	75	6.9	37	10
T45	75	8	41	10
T50	75	9	45	10
T55	75	11.4	55	10
T60	75	13.5	67	10

183T-150 (T)	L (mm)	R (mm)	(g)	(pcs.)
T30	150	6	50	10
T40	150	6.9	58	10
T45	150	8	70	10
T50	150	9	82	10
T55	150	11.4	113	10

183T-35 (IP)	L (mm)	(g)	(pcs.)
30IP	35	18	10
40IP	35	20	10
45IP	35	22	10
50IP	35	26	10
55IP	35	30	10
60IP	35	38	10

183T-75 (IP)	L (mm)	R (mm)	(g)	(pcs.)
30IP	75	6	35	10
40IP	75	6.8	37	10
45IP	75	8	41	10
50IP	75	9	45	10
55IP	75	11.4	56	10
60IP	75	13.5	67	10

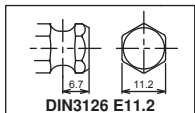

183T-35 / -75 (IP)

TORXPLUS® Bits
TORXPLUS® Bits
Embout TORXPLUS®

TORXplus

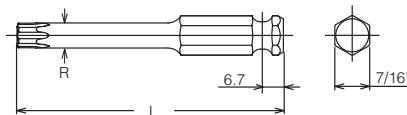

183X-35 (XZN)	L (mm)	(g)	(pcs.)
M 4	35	18	10
M 5	35	18	10
M 6	35	20	10
M 8	35	22	10
M10	35	26	10
M12	35	30	10
M14	35	38	10

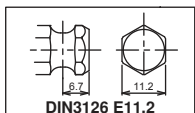

183X-35 / -75 / -150 (XZN)

XZN Bits
XZN Bits
Embout, XZN

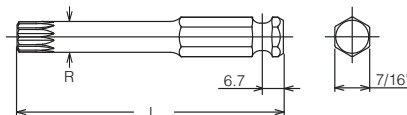

183X-75 (XZN)	L (mm)	R (mm)	(g)	(pcs.)
M 4	75	6	34	10
M 5	75	6	34	10
M 6	75	6.2	36	10
M 8	75	7.4	39	10
M10	75	9.8	54	10
M12	75	11.7	57	10
M14	75	13.5	67	10

183X-150 (XZN)	L (mm)	R (mm)	(g)	(pcs.)
M 5	150	6	50	10
M 6	150	6.2	53	10
M 8	150	7.4	64	10
M10	150	9.8	93	10
M12	150	11.7	121	10

The items with ⚠ have larger output size than 7/16" input hex drive.
Due to this design the Maximum output torque rating is less than standards.

TORX® and TORXplus® are registered trademarks of CAMCAR Innovations.
TORX® und TORXplus® sind eingetragene Markenzeichen der Firma CAMCAR Innovations.
TORX® et TORXplus® sont des marques déposées sous le nom de la société CAMCAR Innovations.

Koken TOOL CO., LTD.

Impact Sockets Impact Steckschlüssel Douilles Impact

1/2"

Z-SERIES
HAND
TITANIUM
SCREWDRIVERS ACCESSORIES
IMPACT
SLEEVE-DRIVE
PROTECTOR
INDUSTRIAL
AUTOMOTIVE
CONSTRUCTION MOTORCYCLE
SPARE PART

14134M-58 / -98

Bit Holder complete with Bit, Inhex
Klingenhälter komplett mit Klinge, Innensechskant
Porte embouts avec bit 6-pans creux



14134M-58 (mm)	D (mm)	H (mm)	L (mm)	R (mm)	(g)	(pcs.)	
3	25	20	58	6	105	10	*1
4	25	20	58	6	105	10	*1
5	25	20	58	6.5	105	10	*1
6	25	20	58	7.5	108	10	*1
7	25	20	58	8.5	110	10	*1
8	25	20	58	9.5	110	10	*1
10	25	20	58	-	116	10	*1
12	25	20	58	-	120	10	*1
14	25	20	58	-	125	10	*1

14134T-58 / -98 (T)

Bit Holder complete with TORX® Bit
Klingenhälter, komplett mit TORX® Klinge
Porte embouts avec bit TORX®



14134M-98 (mm)	D (mm)	H (mm)	L (mm)	R (mm)	(g)	(pcs.)	
3	25	20	98	6	124	5	*1
4	25	20	98	6	125	5	*1
5	25	20	98	6.5	126	5	*1
6	25	20	98	7.5	129	5	*1
7	25	20	98	8.5	135	5	*1
8	25	20	98	9.5	137	5	*1
10	25	20	98	-	147	5	*1
12	25	20	98	-	155	5	*1
14	25	20	98	-	169	5	*1

*1 C-Ring=C41, Pin/O-Ring=A41/B41 → P256-257

14134T-58 / -98 (IP)

Bit Holder complete with TORXPLUS® Bit
Klingenhälter, komplett mit TORXPLUS® Klinge
Porte embouts avec bit TORXPLUS®



14134T-58 (T)	D (mm)	H (mm)	L (mm)	R (mm)	(g)	(pcs.)	
T25	25	20	58	6	108	10	*1
T30	25	20	58	6	108	10	*1
T40	25	20	58	6.9	110	10	*1
T45	25	20	58	8	112	10	*1
T50	25	20	58	9	116	10	*1
T55	25	20	58	11.4	120	10	*1
T60	25	20	58	13.5	128	10	*1

14134T-98 (T)	D (mm)	H (mm)	L (mm)	R (mm)	(g)	(pcs.)	
T30	25	20	98	6	125	5	*1
T40	25	20	98	6.9	127	5	*1
T45	25	20	98	8	131	5	*1
T50	25	20	98	9	135	5	*1
T55	25	20	98	11.4	145	5	*1
T60	25	20	98	13.5	157	5	*1

*1 C-Ring=C41, Pin/O-Ring=A41/B41 → P256-257

14134X-58 / -98 (XZN)

Bit Holder complete with XZN Bit
Klingenhälter, komplett mit XZN Klinge
Porte embouts avec bit XZN



14134T-58 (IP)	D (mm)	H (mm)	L (mm)	R (mm)	(g)	(pcs.)	
30IP	25	20	58	6	108	10	*1
40IP	25	20	58	6.8	110	10	*1
45IP	25	20	58	8	112	10	*1
50IP	25	20	58	9	116	10	*1
55IP	25	20	58	11.4	120	10	*1
60IP	25	20	58	13.5	128	10	*1

14134T-98 (IP)	D (mm)	H (mm)	L (mm)	R (mm)	(g)	(pcs.)	
30IP	25	20	98	6	125	5	*1
40IP	25	20	98	6.8	127	5	*1
45IP	25	20	98	8	131	5	*1
50IP	25	20	98	9	135	5	*1
55IP	25	20	98	11.4	146	5	*1
60IP	25	20	98	13.5	159	5	*1

*1 C-Ring=C41, Pin/O-Ring=A41/B41 → P256-257

14134X-58 (XZN)	D (mm)	H (mm)	L (mm)	R (mm)	(g)	(pcs.)	
M 5	25	20	58	6	108	10	*1
M 6	25	20	58	6.2	110	10	*1
M 8	25	20	58	7.4	112	10	*1
M10	25	20	58	9.8	116	10	*1
M12	25	20	58	11.7	120	10	*1
M14	25	20	58	13.5	128	10	*1

14134X-98 (XZN)	D (mm)	H (mm)	L (mm)	R (mm)	(g)	(pcs.)	
M 5	25	20	98	6	124	5	*1
M 6	25	20	98	6.2	126	5	*1
M 8	25	20	98	7.4	129	5	*1
M10	25	20	98	9.8	144	5	*1
M12	25	20	98	11.7	149	5	*1
M14	25	20	98	13.5	159	5	*1

*1 C-Ring=C41, Pin/O-Ring=A41/B41 → P256-257

⚠ The items with ⚠ have larger output size than 7/16" input hex drive.
Due to this design the Maximum output torque rating is less than standards.

	D ₁ (mm)	D ₂ (mm)	L (mm)	(g)	(pcs.)	
14106	28	30	43	160	10	*2

*2 C-Ring=C42, Pin/O-Ring=A42/B42 → P256-257

14106-SC

Replacement Screw : M6x8, ●3mm

14106 ○ Bit Holder Klingenhalter Porte-embout

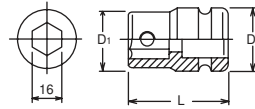

107-16 (mm)	L (mm)	(g)	(pcs.)
10	40	46	10
12	40	52	10
13	40	56	10
14	40	60	10
16	40	69	10
17	40	73	10
18	40	78	10
19	40	80	10
22	40	97	10

107-16 ● Bits for Inhex Screws Klingen für Innensechskant-Schrauben Embouts pour vis 6-pans males creux

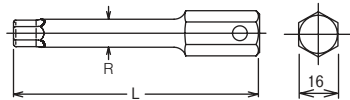
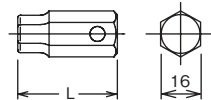

107-16 (inch)	L (mm)	(g)	(pcs.)
3/8	40	45	10
7/16	40	53	10
1/2	40	56	10
9/16	40	60	10
5/8	40	69	10
3/4	40	80	10

107-16(L100) (mm)	L (mm)	R (mm)	(g)	(pcs.)
10	100	13	118	10
12	100	15	141	10
14	100	-	163	10
17	100	-	185	10
19	100	-	228	10
22	100	-	293	10

107-16 (T) ★ TORX® Bits TORX® Klingen Embouts, TORX®

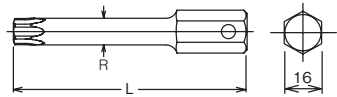
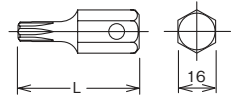

107-16 (T)	L (mm)	(g)	(pcs.)
T45	50	45	10
T50	50	50	10
T55	50	57	10
T60	50	64	10
T70	50	73	10

107-16(L100) (T)	L (mm)	R (mm)	(g)	(pcs.)
T45	100	8	95	10
T50	100	9	100	10
T55	100	11.4	104	10
T60	100	13.4	123	10
T70	100	15.7	148	10

107-16 (IP) ★ TORXPLUS® Bits TORXPLUS® Klingen Embouts TORXPLUS®

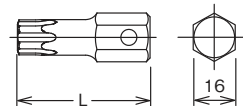

107-16 (IP)	L (mm)	(g)	(pcs.)
55IP	50	57	10
60IP	50	64	10
70IP	50	73	10

107-16 (XZN) ● Bits XZN Klingen XZN Embouts de vissage, XZN

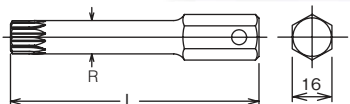
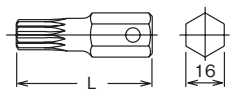

107-16 (XZN)	L (mm)	(g)	(pcs.)
M14	60	83	10
M16	60	93	10
M18	60	103	10

107-16(L100) (XZN)	L (mm)	R (mm)	(g)	(pcs.)
M14	100	13.4	126	10
M16	100	15.8	153	10
M18	100	17.1	173	10

⚠ The items with ⚠ have larger output size than 16mm input hex drive.
Due to this design the Maximum output torque rating is less than standards.

Impact Sockets Impact Steckschlüssel Douilles Impact

1/2"

Z-SERIES
HAND
TITANIUM
SCREWDRIVERS ACCESSORIES
IMPACT
SLEEVE-DRIVE
PROTECTOR
INDUSTRIAL
AUTOMOTIVE
MOTORCYCLE
CONSTRUCTION
SPARE PART

14139 ○ Bit Holder Klingenhalter Porte-embouts

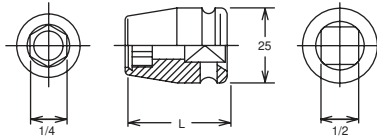

	D ₁ (mm)	D ₂ (mm)	L (mm)	(g)	(pcs.)	⚡
14139-1/4	11	25	35	62	10	*1

*1 C-Ring=C41, Pin/O-Ring=A41/B41 → P256-257

For DIN3126 C6.3 Bits
Für DIN3126 C6.3 Bits
Pour DIN3126 C6.3 Embouts

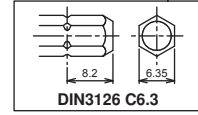

14140 ○ Bit Holder Klingenhalter Porte-embouts

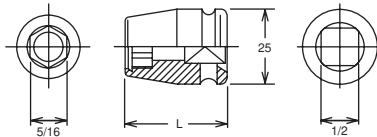

	D ₁ (mm)	D ₂ (mm)	L (mm)	(g)	(pcs.)	⚡
14140-5/16	14	25	35	62	10	*1

*1 C-Ring=C41, Pin/O-Ring=A41/B41 → P256-257

For DIN3126 C8 Bits
Für DIN3126 C8 Bits
Pour DIN3126 C8 Embouts

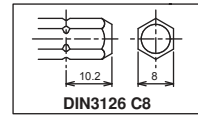

14142-D6.3 ○ Bit Holder (Quick Release) Kingenhalter (Schnellwechselfutter) Porte embouts (mandrin autoserrant) ⚠

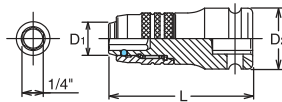

	D ₁ (mm)	D ₂ (mm)	L (mm)	(g)	(pcs.)	⚡
14142-D6.3	16	25	55	97	10	*1

*1 C-Ring=C41, Pin/O-Ring=A41/B41 → P256-257

For DIN3126 C6.3 Bits
Für DIN3126 C6.3 Bits
Pour DIN3126 C6.3 Embouts

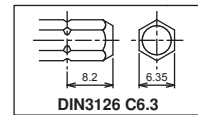

⚠ You may not hold the sliding part while moving to avoid heating up by friction and reduction by wear.

14142-F6.3 ○ Bit Holder (Quick Release) Kingenhalter (Schnellwechselfutter) Porte embouts (mandrin autoserrant) ⚠

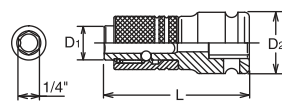

	D ₁ (mm)	D ₂ (mm)	L (mm)	(g)	(pcs.)	⚡
14142-F6.3	16.5	25	55	100	10	*1

*1 C-Ring=C41, Pin/O-Ring=A41/B41 → P256-257

For DIN3126 E6.3 Bits
Für DIN3126 E6.3 Bits
Pour DIN3126 E6.3 Embouts

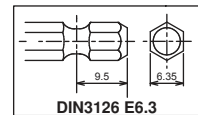

Lock & Quick Release

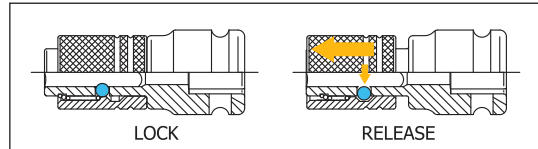

⚠ You may not hold the sliding part while moving to avoid heating up by friction and reduction by wear.

14760-P 14760

Extension Bars
Verlängerungen
Rallonges



	TYPE	D (mm)	L (mm)	(g)	(pcs.)	⚡
14760-50P	Pin	30	50	150	10	*2
14760-75P	Pin	30	75	188	10	*2
14760-100P	Pin	30	100	240	10	*2
14760-125P	Pin	30	125	275	5	*2
14760-150P	Pin	30	150	300	5	*2
14760-175P	Pin	30	175	358	5	*2
14760-200P	Pin	30	200	405	5	*2
14760-250P	Pin	30	250	480	1	*2
New 14760-300P	Pin	30	300	575	1	*2

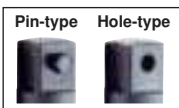
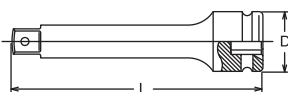

	TYPE	D (mm)	L (mm)	(g)	(pcs.)	⚡
14760-50	Hole	30	50	150	10	*2
14760-75	Hole	30	75	188	10	*2
14760-100	Hole	30	100	240	10	*2
14760-125	Hole	30	125	275	5	*2
14760-150	Hole	30	150	300	5	*2
14760-175	Hole	30	175	358	5	*2
14760-200	Hole	30	200	405	5	*2
14760-250	Hole	30	250	480	1	*2
New 14760-300	Hole	30	300	575	1	*2

*2 C-Ring=C42, Pin/O-Ring=A42/B42 → P256-257

	L (mm)	(g)	(pcs.)	⚡
14444AL	60	128	10	*1

*1 C-Ring=C41, Pin/O-Ring=A41/B41 → P256-257

Lock & Quick Release

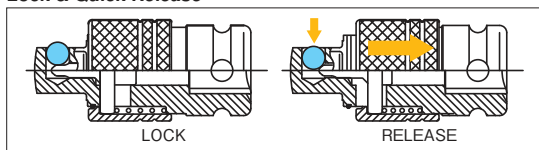

⚠ You may not hold the sliding part while moving to avoid heating up by friction and reduction by wear.



14444AL

Adaptor (Quick Release)
Verbindungsstück (Quick Release) ⚠
Adaptateur (Quick Release)

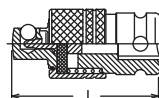

	(sq.)	(sq.)	L (mm)	(g)	(pcs.)	⚡
New 14466AL	1/2"	3/4"	75	460	5	*2

*2 C-Ring=C42, Pin/O-Ring=A42/B42 → P256-257

⚠ You may not hold the sliding part while moving to avoid heating up by friction and reduction by wear.

14466AL

Adaptor (Quick Release)
Adaptador (Extracción Rápida) ⚠

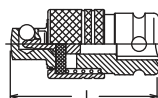

Impact Sockets Impact Steckschlüssel Douilles Impact

1/2"

Z-SERIES
HAND
TITANIUM
SCREWDRIVERS ACCESSORIES
IMPACT
SLEEVE-DRIVE
PROTECTOR
INDUSTRIAL
AUTOMOTIVE
MOTORCYCLE
CONSTRUCTION
SPARE PART

14770-P 14770

Universal Joint
Gelenk-Einsatz
Joint articulé

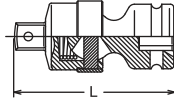
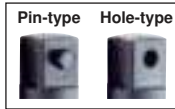

	TYPE	L (mm)	(g)	(pcs.)	
14770-P	Pin	74	210	5	*2
14770	Hole	74	210	5	*2
14771-P	Pin	65	198	5	*2
14771	Hole	65	198	5	*2

*2 C-Ring=C42, Pin/O-Ring=A42/B42 → P256-257

Our ball joints are spring-loaded and can therefore be adjusted to an angle of max. 30°.

Unsere Kugelgelenke sind federbelastet dadurch sind sie auf einen Winkel von max 30° einstellbar.

Nos joints à rotule sont à ressort et peuvent donc être réglés jusqu'à un angle de 30° maximum.

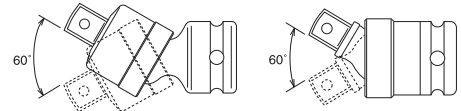

14771-P 14771

Universal Joint
Gelenk-Einsatz
Joint articulé

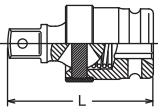

14772-P 14772-B

Universal Double Joint
Doppelgelenk-Einsatz
Joint articulé double

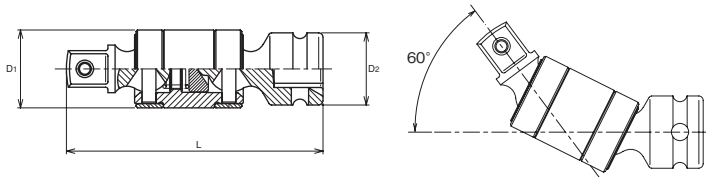

	TYPE	D1 (mm)	D2 (mm)	L (mm)	(g)	(pcs.)	
14772-P	Pin	27	25	90	230	5	*1
14772-B	Hole	27	25	90	230	5	*1

*1 C-Ring=C41, Pin/O-Ring=A41/B41 → P256-257



Make sure sockets hold bolts or nuts before operation.

Vergewissern Sie sich vor dem Gebrauch, dass der Steckschlüssel die Schraube sicher umfasst hat.

Avant la manipulation, il est nécessaire de s'assurer que la douille renferme parfaitement la vis.

⚠ 13772 and 14772 have less load capacity than standard. In the interest of your safety always use properly.

14433A-P 14433A

Adaptor
Verbindungsstück
Réducteur

No Warranty
Keine Garantie
Sans Garantie

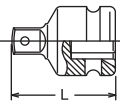

	TYPE	(sq.)	(sq.)	L (mm)	(g)	(pcs.)	
14433A-P	Pin	1/2"	3/8"	37.5	68	10	*1
14433A	Hole	1/2"	3/8"	37.5	68	10	*1

*1 C-Ring=C41, Pin/O-Ring=A41/B41 → P256-257

⚠ Adapting down from bigger square drive to smaller square drive may lead to excessive torque load and possibly cause breakage. Always stay within safe torque of the smaller square drive.

Die mit ⚠ gekennzeichneten Artikel können bei Überbelastung zu Bruch gehen. Aus Gründen Ihrer eigenen Sicherheit sollten die betreffenden Werkzeuge nie ruckartig, sondern nach und nach belastet werden, um Bruch und damit verbundene mögliche Verletzungen zu vermeiden.

Il est possible d'appliquer aux articles marqués ⚠ des couples de serrage susceptibles d'occasionner leur rupture. Pour votre propre sécurité, veuillez toujours appliquer la charge d'une manière uniforme et progressive. Ceci pour éviter ruptures et accidents.

14455A

Adaptor
Verbindungsstück
Augmentateur

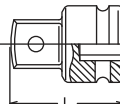

14466A

Adaptor
Verbindungsstück
Augmentateur

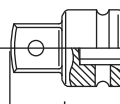

	(sq.)	(sq.)	L (mm)	(g)	(pcs.)	
14455A	1/2"	5/8"	42	135	10	*2





*2 C-Ring=C42, Pin/O-Ring=A42/B42 → P256-257

	(sq.)	(sq.)	L (mm)	(g)	(pcs.)	
14466A	1/2"	3/4"	44	146	10	*2

*2 C-Ring=C42, Pin/O-Ring=A42/B42 → P256-257

14209M 10 Pieces Set/△=830g

METAL CASE:W190×H59×T45mm

Bits	Bit Holder
 183H.35 Hex Bits 5, 6, 8, 10	 14134 Bit Holder
 107.16 Hex Bits 12, 14, 17, 19	 14106 Bit Holder

 × 





 ×  **DIN3126**

14209M  Socket Sets
Steckschlüssel Sätze
Jeu de clés à douilles



14210M 18 Pieces Set/△=1,250g

METAL CASE:W310×H90×T48mm

Bits	Bit Holder
 183H.35 Hex Bits 4, 5, 6, 7, 8, 10, 12, 14	 14134 Bit Holder
 183H.75 Hex Bits 4, 5, 6, 7, 8, 10, 12, 14	 168H-4 (40) Screwdriver

 × 





 ×  **DIN3126**

14210M  Socket Sets
Steckschlüssel Sätze
Jeu de clés à douilles



14210T 14 Pieces Set/△=1,080g

METAL CASE:W310×H90×T48mm

Bits	Bit Holder
 183T.35 TORX® Bits T30, T40, T45, T50, T55, T60	 14134 Bit Holder
 183T.75 TORX® Bits T30, T40, T45, T50, T55, T60	 168H-4 (40) Screwdriver

 × 





 ×  **DIN3126**

14210T  Socket Sets
Steckschlüssel Sätze
Jeu de clés à douilles



14210X 14 Pieces Set/△=1,040g

METAL CASE:W310×H90×T48mm

Bits	Bit Holder
 183X.35 XZN Bits M4, M5, M6, M8, M10, M12	 14134 Bit Holder
 183X.75 XZN Bits M4, M5, M6, M8, M10, M12	 168H-4 (40) Screwdriver

 × 

 ×  **DIN3126**

14210X  Socket Sets
Steckschlüssel Sätze
Jeu de clés à douilles



Impact Sockets
Impact Steckschlüssel
Douilles Impact

1/2"

Z-SERIES

HAND

TITANIUM

ACCESSORIES

SCREWDRIVERS

IMPACT

SLEEVE-DRIVE

PROTECTOR

INDUSTRIAL

AUTOMOTIVE

MOTORCYCLE

CONSTRUCTION

SPARE PART

14207M  Socket Set
Steckschlüssel Satz
Jeu de clés à douilles



14207M 10 Pieces Set/⚖️=2,700g

METAL CASE:W310×H90×T48mm

Sockets

 **14300M** 6-pt Deep Sockets
10, 12, 13, 14, 17, 19, 21, 22, 24, 27

14208M  Socket Set
Steckschlüssel Satz
Jeu de clés à douilles



14208M 13 Pieces Set/⚖️=3,500g

METAL CASE:W395×H90×T50mm

Sockets

 **14300M** 6-pt Deep Sockets
10, 12, 13, 14, 15, 16, 17, 18, 19, 21, 22, 24, 27

14241M-00  Socket Set
Steckschlüssel Satz
Jeu de clés à douilles



14241M-00 13 Pieces Set/⚖️=2,000g

METAL CASE:W196×H100×T45mm

Sockets

 **14400M** 6-pt. Sockets
10, 11, 12, 13, 14, 15, 16, 17, 19, 21, 22, 24, 27

14241M-05 

14241M-05 13 Pieces Set/⚖️=2,000g

METAL CASE:W196×H100×T45mm

Sockets

 **14405M** 12-pt. Sockets
10, 11, 12, 13, 14, 15, 16, 17, 19, 21, 22, 24, 27

14242M  Socket Set
Steckschlüssel Satz
Jeu de clés à douilles



14242M 12 Pieces Set/⚖️=1,890g

METAL CASE:W310×H90×T48mm

Sockets

 **14400M** 6-pt. Sockets
10, 11, 12, 13, 14, 15, 16, 17, 19, 21, 22, 27

14245M-00  Socket Set
Steckschlüssel Satz
Jeu de clés à douilles







14245M-00 18 Pieces Set/⚖️=2,250g

METAL CASE:W310×H90×T48mm

Sockets

 **14400M** 6-pt. Sockets
10, 12, 13, 14, 16, 17, 18,
19, 21, 22, 24, 27

Accessories

 **14760-125P**
 **14770-P**
 **1401A, 1402A**
 **1401B, 1402B**





14245M-05 18 Pieces Set/⚖️=2,250g

METAL CASE:W310×H90×T48mm

Sockets

 **14405M** 12-pt. Sockets
10, 12, 13, 14, 16, 17, 18,
19, 21, 22, 24, 27

Accessories

 **14760-125P**
 **14770-P**
 **1401A, 1402A**
 **1401B, 1402B**

15400M (mm)	D ₁ (mm)	D ₂ (mm)	H (mm)	L (mm)	(g)	(pcs.)	
14	24	35	10	47.5	220	5	*1
17	27.8	35	12	47.5	225	5	*1
19	30.3	35	13	47.5	225	5	*1
21	32.8	35	15	47.5	225	5	*1
22	34	35	15	47.5	225	5	*1
23	35.4	35	16	47.5	225	5	*1
24	36.5	35	16	50.5	245	5	*1
26	39	35	16	50.5	260	5	*1

*1 Pin/O-Ring=A51/B51 → P257



15400M 6-point Sockets
6-kant Steckschlüssel
Douilles 6-pans

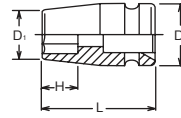

15410M (mm)	D ₁ (mm)	D ₂ (mm)	H (mm)	L (mm)	(g)	(pcs.)	
14	24	35	10	47.5	220	5	*1
17	27.8	35	12	47.5	225	5	*1
19	30.3	35	13	47.5	225	5	*1
21	32.8	35	15	47.5	225	5	*1
22	34	35	15	47.5	225	5	*1
23	35.4	35	16	47.5	225	5	*1
24	36.5	35	16	50.5	245	5	*1
26	39	35	16	50.5	260	5	*1

*1 Pin/O-Ring=A51/B51 → P257



15410M Surface Drive Sockets
Surface Drive Steckschlüssel
Douilles, Surface Drive

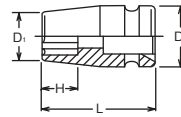

15300M (mm)	D ₁ (mm)	D ₂ (mm)	H ₁ (mm)	H ₂ (mm)	L (mm)	(g)	(pcs.)	
14	24	35	14	71	90	295	2	*1
17	27.8	35	17	71	90	325	2	*1
19	30.3	35	19	71	90	350	2	*1
21	32.8	35	21	71	90	380	2	*1
22	34	35	22	71	90	390	2	*1

*1 Pin/O-Ring=A51/B51 → P257

15300M 6-point Deep Sockets
6-kant-Steckschlüssel, lang
Douilles longues 6-pans

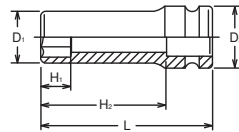

15310M (mm)	D ₁ (mm)	D ₂ (mm)	H ₁ (mm)	H ₂ (mm)	L (mm)	(g)	(pcs.)	
14	24	35	14	71	90	295	2	*1
17	27.8	35	17	71	90	325	2	*1
19	30.3	35	19	71	90	350	2	*1
21	32.8	35	21	71	90	380	2	*1
22	34	35	22	71	90	390	2	*1

*1 Pin/O-Ring=A51/B51 → P257

15310M Surface Drive Sockets, deep
Surface Drive Steckschlüssel, lang
Douilles longues, Surface Drive

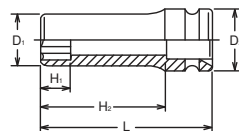

Impact Sockets
Impact Steckschlüssel
Douilles Impact

5/8"

Z-SERIES
HAND
TITANIUM
SCREWDRIVERS ACCESSORIES
IMPACT
SLEEVE-DRIVE
PROTECTOR
INDUSTRIAL
AUTOMOTIVE
MOTORCYCLE
CONSTRUCTION
SPARE PART

15555AL Adaptor (Quick Release)
Schnellwechsel-Verbindungsstück (Quick Release)
Adaptateur (Quick Release) 

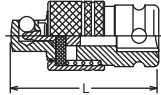

	L (mm)	(g)	(pcs.)	
15555AL	70	310	2	*1

*1 Pin/O-Ring=A51/B51 → P257

Lock & Quick Release

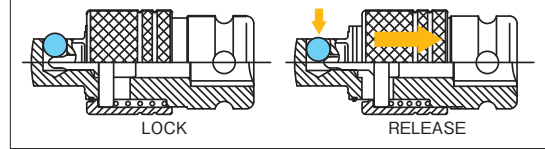

 You may not hold the sliding part while moving to avoid heating up by friction and reduction by wear.

15770 Universal Joint
Gelenk-Einsatz
Joint articulé

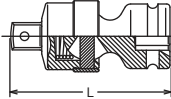

	L (mm)	(g)	(pce.)	
15770	88	420	1	*1

*1 Pin/O-Ring=A51/B51 → P257

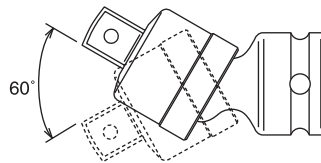

Our ball joints are spring-loaded and can therefore be adjusted to an angle of max. 30°.

Unsere Kugelgelenke sind federbelastet dadurch sind sie auf einen Winkel von max 30° einstellbar.

Nos joints à rotule sont à ressort et peuvent donc être réglés jusqu'à un angle de 30° maximum.

15544A-P Adaptor
Verbindungsstück
Réducteur 

15544A No Warranty
Keine Garantie
Sans Garantie

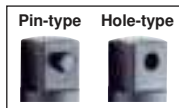
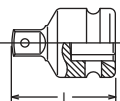

	(sq.)	(sq.)	L (mm)	(g)	(pce.)	
15544A-P	5/8"	1/2"	46	165	1	*1
15544A	5/8"	1/2"	46	165	1	*1

*1 Pin/O-Ring=A51/B51 → P257

 Adapting down from bigger square drive to smaller square drive may lead to excessive torque load and possibly cause breakage. Always stay within safe torque of the smaller square drive.

Die mit  gekennzeichneten Artikel können bei Überbelastung zu Bruch gehen. Aus Gründen Ihrer eigenen Sicherheit sollten die betreffenden Werkzeuge nie ruckartig, sondern nach und nach belastet werden, um Bruch und damit verbundene mögliche Verletzungen zu vermeiden.

Il est possible d'appliquer aux articles marqués  des couples de serrage susceptibles d'occasionner leur rupture. Pour votre propre sécurité, veuillez toujours appliquer la charge d'une manière uniforme et progressive. Ceci pour éviter ruptures et accidents.

15566A Adaptor
Verbindungsstück
Augmentateur

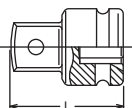

	(sq.)	(sq.)	L (mm)	(g)	(pce.)	
15566A	5/8"	3/4"	48	200	1	*1

*1 Pin/O-Ring=A51/B51 → P257

3/4"

Impact Sockets
Impact Steckschlüssel
Douilles Impact

16400M (mm)	D ₁ (mm)	D ₂ (mm)	H (mm)	L (mm)	(g)	(pcs.)	
16	28.8	44	11	50	367	5	*1
17	30	44	12	50	355	5	*1
18	31.3	44	13	50	372	5	*1
19	32.5	44	13	50	360	5	*1
20	33.8	44	14	50	375	5	*1
21	35	44	15	50	374	5	*1
22	36.3	44	15	50	373	5	*1
23	37.5	44	16	50	373	5	*1
24	38.8	44	16	50	370	5	*1
25	40	44	16	50	374	5	*1
26	41.3	44	16	50	378	5	*1
27	42.5	44	16	50	375	5	*1
28	43.8	44	16	50	383	5	*1
29	45	44	18	53	412	5	*1
30	46.3	44	18	53	410	5	*1
31	47.5	44	18	53	426	5	*1
32	48.8	44	19	53	428	5	*1
33	50	44	20	55	470	5	*1
34	51.3	44	20	55	490	5	*1
35	52.5	44	20	55	494	5	*1
36	53.8	44	20	55	498	5	*1
37	55	44	20	55	526	2	*1
38	56.3	44	20	57	558	2	*1
39	57.5	44	20	57	579	2	*1
40	58.8	44	20	57	598	2	*1
41	60	44	22	57	572	2	*1
42	61.3	44	22	57	617	2	*1
43	62.5	44	23	62	720	2	*1
44	63.8	44	23	62	761	2	*1
45	65	44	23	62	757	2	*1
46	66.3	44	23	62	755	2	*1
47	67.5	54	23	62	805	2	*2
48	68.8	54	23	62	940	2	*2
49	70	54	23	62	912	2	*2
50	71.3	54	30	62	930	2	*2
52	73.8	54	29	62	1011	2	*2
54	76.3	54	29	62	1035	2	*2
55	77.5	54	29	62	1056	2	*2
56	78.8	54	29	62	1091	2	*2
57	80	54	32	65	1126	2	*2
58	81.3	54	31	65	1163	2	*2
59	82.5	54	31	65	1185	2	*2
60	83.8	54	31	65	1215	2	*2
65	90	54	30	65	1325	2	*2
70	96.3	54	34	70	1570	1	*2

*1 C-Ring=C61, Pin/O-Ring=A61/B61 → P256-257
*2 C-Ring=C81, Pin/O-Ring=A62/B62



16400M / 16400A

6-point Sockets
6-kant Steckschlüssel
Douilles 6-pans

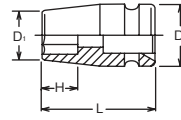

16400A (inch)	D ₁ (mm)	D ₂ (mm)	H (mm)	L (mm)	(g)	(pcs.)	
5/8	28.8	44	11	50	366	5	*1
11/16	30	44	12	50	355	5	*1
3/4	32.5	44	13	50	360	5	*1
13/16	35	44	15	50	374	5	*1
7/8	36.3	44	15	50	373	5	*1
15/16	38.8	44	16	50	370	5	*1
1	40	44	16	50	374	5	*1
1. 1/16	42.5	44	16	50	375	5	*1
1. 1/8	45	44	18	53	412	5	*1
1. 3/16	46.3	44	18	53	410	5	*1
1. 1/4	48.8	44	19	53	428	5	*1
1. 5/16	51.3	44	20	55	490	5	*1
1. 3/8	52.5	44	20	55	494	5	*1
1. 7/16	55	44	20	55	526	2	*1
1. 1/2	56.3	44	20	57	558	2	*1
1. 9/16	58.8	44	20	57	598	2	*1
1. 5/8	60	44	22	57	572	2	*1
1.11/16	62.5	44	23	62	720	2	*1
1. 3/4	65	44	23	62	757	2	*1
1.13/16	66.3	44	23	62	755	2	*1
1. 7/8	68.8	54	23	62	940	2	*2
1.15/16	70	54	23	62	912	2	*2
2	72.5	54	30	62	969	2	*2
2. 1/16	73.8	54	29	62	1011	2	*2
2. 1/8	76.3	54	29	62	1035	2	*2
2. 3/16	77.5	54	29	62	1056	2	*2
2. 1/4	80	54	32	65	1126	2	*2
2. 5/16	81.3	54	31	65	1163	2	*2
2. 3/8	83.8	54	31	65	1215	2	*2

16405M (mm)	D ₁ (mm)	D ₂ (mm)	H (mm)	L (mm)	(g)	(pcs.)	
17	30	44	12	50	355	5	*1
18	31.3	44	13	50	372	5	*1
19	32.5	44	13	50	360	5	*1
20	33.8	44	14	50	375	5	*1
21	35	44	15	50	374	5	*1
22	36.3	44	15	50	373	5	*1
23	37.5	44	16	50	373	5	*1
24	38.8	44	16	50	370	5	*1
25	40	44	16	50	374	5	*1
26	41.3	44	16	50	378	5	*1
27	42.5	44	16	50	375	5	*1
28	43.8	44	16	50	383	5	*1
29	45	44	18	53	412	5	*1
30	46.3	44	18	53	410	5	*1
32	48.8	44	19	53	428	5	*1
33	50	44	20	55	470	5	*1
34	51.3	44	20	55	490	5	*1
35	52.5	44	20	55	494	5	*1
36	53.8	44	20	55	498	5	*1
38	56.3	44	20	57	558	2	*1
41	60	44	22	57	572	2	*1
42	61.3	44	22	57	617	2	*1
46	66.3	44	23	62	755	2	*1
50	71.3	54	30	62	930	2	*2
52	73.8	54	29	62	1011	2	*2
55	77.5	54	29	62	1056	2	*2
60	83.8	54	31	65	1215	2	*2
65	90	54	30	65	1325	2	*2

*1 C-Ring=C61, Pin/O-Ring=A61/B61 → P256-257
*2 C-Ring=C81, Pin/O-Ring=A62/B62

16405M / 16405A

12-point Sockets
12-kant Steckschlüssel
Douilles 12-pans

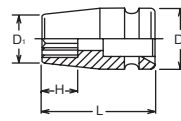

16405A (inch)	D ₁ (mm)	D ₂ (mm)	H (mm)	L (mm)	(g)	(pcs.)	
3/4	32.5	44	13	50	360	5	*1
13/16	35	44	15	50	374	5	*1
7/8	36.3	44	15	50	373	5	*1
15/16	38.8	44	16	50	370	5	*1
1	40	44	16	50	374	5	*1
1. 1/16	42.5	44	16	50	375	5	*1
1. 1/8	45	44	18	53	412	5	*1
1. 3/16	46.3	44	18	53	410	5	*1
1. 1/4	48.8	44	19	53	428	5	*1
1. 5/16	51.3	44	20	55	490	5	*1
1. 3/8	52.5	44	20	55	494	5	*1
1. 7/16	55	44	20	55	526	2	*1
1. 1/2	56.3	44	20	57	558	2	*1
1. 5/8	60	44	22	57	572	2	*1
1.11/16	62.5	44	23	62	720	2	*1
1. 3/4	65	44	23	62	757	2	*1
1. 7/8	68.8	54	23	62	940	2	*2
2	72.5	54	30	62	969	2	*2

New

Z-SERIES
HAND
TITANIUM
ACCESSORIES
SCREWDRIVERS
IMPACT
SLEEVE-DRIVE
PROTECTOR
INDUSTRIAL
AUTOMOTIVE
MOTORCYCLE
CONSTRUCTION
SPARE PART

Z-SERIES
HAND
TITANIUM
SCREWDRIVERS ACCESSORIES
IMPACT
SLEEVE-DRIVE
PROTECTOR
INDUSTRIAL
AUTOMOTIVE
MOTORCYCLE
CONSTRUCTION
SPARE PART

16401M / 16401A

6-point Sockets, Thin Walled
6-kant Steckschlüssel, dünnwandig
Douilles à paroi mince, 6-pans

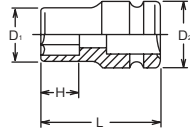

16401M (mm)	D ₁ (mm)	D ₂ (mm)	H (mm)	L (mm)	(g)	(pcs.)	⚡
New 16	26.8	43	11	50	290	5	*1
17	28	43	12	50	300	5	*1
18	29.3	43	13	50	300	5	*1
19	30.5	43	13	50	300	5	*1
20	31.8	43	14	50	302	5	*1
21	33	43	15	50	305	5	*1
22	34.3	43	15	50	310	5	*1
23	35.5	43	16	50	315	5	*1
24	36.8	43	16	50	325	5	*1
25	38	43	16	50	326	5	*1
26	39.3	43	16	50	330	5	*1
27	40.5	43	16	50	340	5	*1
28	41.8	43	16	50	345	5	*1
29	43	43	18	53	355	5	*1
30	44.3	43	18	53	365	5	*1
31	45.5	43	18	53	375	5	*1
32	46.8	43	19	53	385	5	*1
33	48	43	20	55	395	5	*1
34	49.3	43	20	55	420	5	*1
35	50.5	43	20	55	430	5	*1
36	51.8	43	20	55	440	5	*1
37	53	43	20	55	460	2	*1
38	54.3	43	20	57	472	2	*1
New 39	55.5	43	20	57	525	2	*1
40	56.8	43	20	57	525	2	*1
41	58	43	22	57	555	2	*1
42	59.3	43	22	57	565	2	*1
43	60.5	43	23	62	662	2	*1
44	61.8	43	23	62	670	2	*1
45	63	43	23	62	700	2	*1
46	64.3	43	23	62	710	2	*1

*1 C-Ring=C61, Pin/O-Ring=A61/B61 → P256-257

16401A (inch)	D ₁ (mm)	D ₂ (mm)	H (mm)	L (mm)	(g)	(pcs.)	⚡
11/16	28	43	12	50	300	5	*1
3/4	30.5	43	13	50	300	5	*1
13/16	33	43	15	50	305	5	*1
7/8	34.3	43	15	50	310	5	*1
15/16	36.8	43	16	50	325	5	*1
1	38	43	16	50	326	5	*1
1. 1/16	40.5	43	16	50	340	5	*1
1. 1/8	43	43	18	53	355	5	*1
1. 3/16	44.3	43	18	53	365	5	*1
1. 1/4	46.8	43	19	53	385	5	*1
1. 5/16	49.3	43	20	55	437	5	*1
1. 3/8	50.5	43	20	55	430	5	*1
1. 7/16	53	43	20	55	460	2	*1
1. 1/2	54.3	43	20	57	472	2	*1
1. 9/16	56.8	43	20	57	525	2	*1
1. 5/8	58	43	22	57	555	2	*1
1.13/16	64.3	43	23	62	710	2	*1
1. 7/8	66.8	53	23	62	868	2	*2

*1 C-Ring=C61, Pin/O-Ring=A61/B61 → P256-257

16410M

Surface Drive Sockets
Surface Drive Steckschlüssel
Douilles, Surface Drive



SURFACE DRIVE

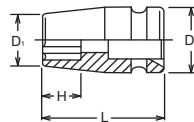

16410M (mm)	D ₁ (mm)	D ₂ (mm)	H (mm)	L (mm)	(g)	(pcs.)	⚡
16	28.8	44	11	50	367	5	*1
17	30	44	12	50	355	5	*1
18	31.3	44	13	50	372	5	*1
19	32.5	44	13	50	360	5	*1
21	35	44	15	50	374	5	*1
22	36.3	44	15	50	373	5	*1
24	38.8	44	16	50	370	5	*1
27	42.5	44	16	50	375	5	*1
30	46.3	44	18	53	410	5	*1
32	48.8	44	19	53	428	5	*1
33	50	44	20	55	470	5	*1
36	53.8	44	20	55	498	5	*1

*1 C-Ring=C61, Pin/O-Ring=A61/B61 → P256-257

3/4"

Impact Sockets
Impact Steckschlüssel
Douilles Impact

16425 (E)	D ₁ (mm)	D ₂ (mm)	H (mm)	L (mm)	(g)	(pcs.)	
E18	26.3	44	13	50	355	5	*1
E20	28.8	44	14.4	50	370	5	*1
E22	31.3	44	15.5	50	390	5	*1
E24	32.5	44	17	50	390	5	*1
E26	35	44	18.8	60	460	5	*1
E28	36.3	44	25.2	60	465	5	*1
E30	38.8	44	25.2	60	480	5	*1
E32	41.3	44	25.2	60	480	5	*1

*1 C-Ring=C61, Pin/O-Ring=A61/B61 → P256-257

16425 TORX® Sockets TORX® Steckschlüssel Douilles TORX®

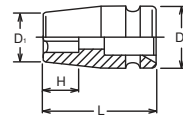

TORX® (E)

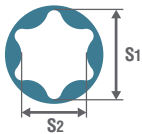

E	E4	E5	E6	E7	E8	E10	E11	E12	E14	E16	E18	E20	E22	E24	E26	E28	E30	E32
S ₁ (ref. mm)	3.7	4.6	5.6	6.1	7.4	9.3	9.9	11.0	12.8	14.6	16.5	18.3	20.1	22.0	23.7	25.5	27.3	29.0
S ₂ (ref. mm)	2.7	3.3	4.0	4.3	5.3	6.8	7.1	7.9	9.2	10.5	11.9	13.2	14.8	15.7	17.5	18.3	20.0	21.3

16425 (EPL)	D ₁ (mm)	D ₂ (mm)	H (mm)	L (mm)	(g)	(pcs.)	
24EPL	32.5	44	12.2	55	427	5	*1
26EPL	35	44	14.2	60	467	5	*1
28EPL	36.3	44	15.2	60	467	5	*1
30EPL	38.8	44	16.1	60	472	5	*1
32EPL	40	44	16.1	62	488	2	*1

*1 C-Ring=C61, Pin/O-Ring=A61/B61 → P256-257

16425-EPL TORXPLUS® Sockets TORXPLUS® Steckschlüssel Douilles TORXPLUS®

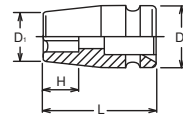

TORXplus® (EP/EPL)

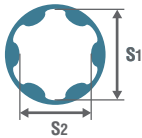

EP/EPL	8EP	10EP	12EP	14EP	16EP	18EP	20EP	22EP	24EP	26EP	28EP	30EP	32EP
S ₁ (ref. mm)	7.4	9.3	11.0	12.8	14.6	16.5	18.3	20.1	22.0	23.7	25.5	27.3	29.0
S ₂ (ref. mm)	5.3	6.8	7.9	9.2	10.5	11.9	13.2	14.8	15.7	17.5	18.3	20.0	21.3



TORXplus®

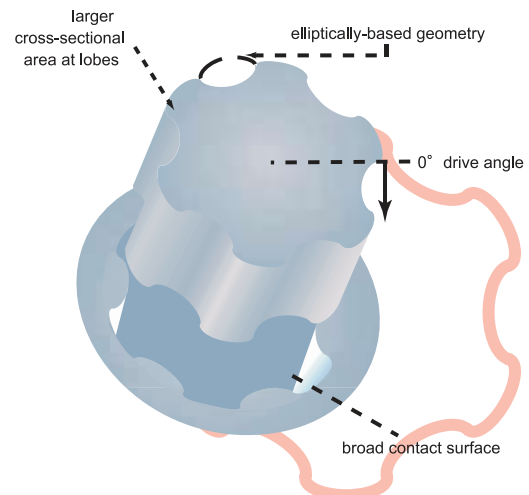
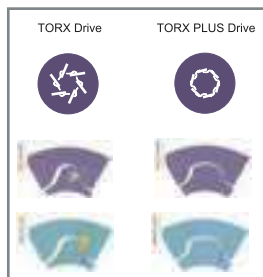
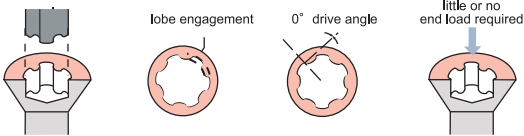

Impact Sockets

Impact Steckschlüssel 3/4"

Douilles Impact

16301X  6-point Semi-Deep Sockets, Thin Walled
6-kant Steckschlüssel mittel lang, dünnwandig
Douilles à paroi mince semi-longues, 6-pans

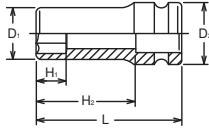

16301X (mm)	D ₁ (mm)	D ₂ (mm)	H ₁ (mm)	H ₂ (mm)	L (mm)	(g)	(pcs.)	
17	28	43	17	49	75	370	2	*1
18	29.3	43	18	49	75	380	2	*1
19	30.5	43	19	49	75	393	2	*1
20	31.8	43	20	49	75	400	2	*1
21	33	43	21	49	75	408	2	*1
22	34.3	43	22	49	75	418	2	*1
23	35.5	43	23	49	75	425	2	*1
24	36.8	43	24	49	75	435	2	*1
25	38	43	25	49	75	449	2	*1
26	39.3	43	26	49	75	455	2	*1
27	40.5	43	27	48	75	464	2	*1
28	41.8	43	28	48	75	479	2	*1
29	43	43	29	48	75	489	2	*1
30	44.3	43	30	48	75	506	2	*1
31	45.5	43	31	47	75	518	2	*1
32	46.8	43	32	47	75	535	2	*1
33	48	43	33	47	75	550	2	*1
35	50.5	43	35	46	75	585	2	*1
36	51.8	43	36	46	75	603	2	*1
37	53	43	37	46	75	645	2	*1
38	54.3	43	38	50	80	691	2	*1
40	56.8	43	38	50	80	725	2	*1
41	58	43	38	49	80	755	2	*1
46	64.3	43	38	48	80	808	2	*1

*1 C-Ring=C61, Pin/O-Ring=A61/B61 → P256-257

16300M / 16300A  6-point Sockets, deep
6-kant Steckschlüssel, lang
Douilles longues, 6-pans

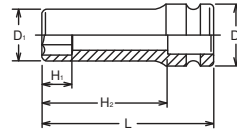

16300M (mm)	D ₁ (mm)	D ₂ (mm)	H ₁ (mm)	H ₂ (mm)	L (mm)	(g)	(pcs.)	
14	26.3	44	14	74	100	497	2	*1
16	28.8	44	16	74	100	524	2	*1
17	30	44	17	74	100	544	2	*1
18	31.3	44	18	74	100	642	2	*1
19	32.5	44	19	74	100	655	2	*1
20	33.8	44	20	74	100	680	2	*1
21	35	44	21	74	100	700	2	*1
22	36.3	44	22	74	100	700	2	*1
23	37.5	44	23	74	100	720	2	*1
24	38.8	44	24	74	100	705	2	*1
25	40	44	25	74	100	715	2	*1
26	41.3	44	26	74	100	710	2	*1
27	42.5	44	27	73	100	710	2	*1
28	43.8	44	28	73	100	800	2	*1
29	45	44	29	73	100	835	2	*1
30	46.3	44	30	73	100	840	2	*1
31	47.5	44	31	72	100	815	2	*1
32	48.8	44	32	72	100	875	2	*1
33	50	44	33	72	100	920	2	*1
34	51.3	44	34	72	100	950	2	*1
35	52.5	44	35	71	100	980	2	*1
36	53.8	44	36	71	100	960	2	*1
37	55	44	37	71	100	970	2	*1
38	56.3	44	38	70	100	990	2	*1
40	58.8	44	38	70	100	1060	2	*1
41	60	44	38	69	100	1120	2	*1
42	61.3	44	38	69	100	1153	2	*1
43	62.5	44	38	69	100	1200	2	*1
44	63.8	44	38	68	100	1220	2	*1
46	66.3	44	38	68	100	1305	2	*1
48	68.8	54	38	68	100	1480	2	*2
50	71.3	54	61	-	100	1469	2	*2
55	77.5	54	59	-	100	1620	2	*2
60	83.8	54	56	-	100	1835	2	*2

*1 C-Ring=C61, Pin/O-Ring=A61/B61
*2 C-Ring=C81, Pin/O-Ring=A62/B62 → P256-257

16300A (inch)	D ₁ (mm)	D ₂ (mm)	H ₁ (mm)	H ₂ (mm)	L (mm)	(g)	(pcs.)	
3/4	32.5	44	19	74	100	655	2	*1
13/16	35	44	21	74	100	700	2	*1
7/8	36.3	44	22	74	100	700	2	*1
15/16	38.8	44	24	74	100	705	2	*1
1	40	44	25	74	100	715	2	*1
1. 1/16	42.5	44	27	73	100	765	2	*1
1. 1/8	45	44	29	73	100	835	2	*1
1. 3/16	46.3	44	30	73	100	840	2	*1
1. 1/4	48.8	44	32	72	100	875	2	*1
1. 5/16	51.3	44	34	72	100	950	2	*1
1. 3/8	52.5	44	35	71	100	980	2	*1
1. 7/16	55	44	37	71	100	970	2	*1
1. 1/2	56.3	44	38	70	100	990	2	*1
1. 9/16	58.8	44	38	70	100	1060	2	*1
1. 5/8	60	44	38	69	100	1120	2	*1
1.11/16	62.5	44	38	69	100	1200	2	*1
1. 3/4	65	44	38	68	100	1284	2	*1
1.13/16	66.3	44	38	68	100	1305	2	*1
1. 7/8	68.8	54	38	67	100	1561	2	*2
2	72.5	54	60	-	100	1516	2	*2

*1 C-Ring=C61, Pin/O-Ring=A61/B61
*2 C-Ring=C81, Pin/O-Ring=A62/B62 → P256-257

Z-SERIES
HAND
TITANIUM
ACCESSORIES
SREWDRIVERS
IMPACT
SLEEVE-DRIVE
PROTECTOR
INDUSTRIAL
AUTOMOTIVE
MOTORCYCLE
CONSTRUCTION
SPARE PART

3/4"

Impact Sockets
Impact Steckschlüssel
Douilles Impact

16301M / 16301A

6-point Deep Sockets, Thin Walled
6-kant Steckschlüssel, dünnwandig
Douilles à paroi mince longues, 6-pans

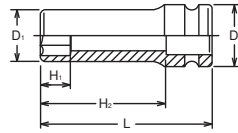

16301M (mm)	D ₁ (mm)	D ₂ (mm)	H ₁ (mm)	H ₂ (mm)	L (mm)	(g)	(pcs.)	
16	26.8	43	16	74	100	435	2	*1
17	28	43	17	74	100	470	2	*1
18	29.3	43	18	74	100	475	2	*1
19	30.5	43	19	74	100	480	2	*1
20	31.8	43	20	74	100	491	2	*1
21	33	43	21	74	100	505	2	*1
22	34.3	43	22	74	100	528	2	*1
23	35.5	43	23	74	100	542	2	*1
24	36.8	43	24	74	100	560	2	*1
25	38	43	25	74	100	581	2	*1
26	39.3	43	26	74	100	600	2	*1
27	40.5	43	27	73	100	610	2	*1
28	41.8	43	28	73	100	639	2	*1
29	43	43	29	73	100	650	2	*1
30	44.3	43	30	73	100	670	2	*1
31	45.5	43	31	72	100	690	2	*1
32	46.8	43	32	72	100	715	2	*1
33	48	43	33	72	100	750	2	*1
34	49.3	43	34	72	100	772	2	*1
35	50.5	43	35	71	100	785	2	*1
36	51.8	43	36	71	100	830	2	*1
37	53	43	37	71	100	850	2	*1
38	54.3	43	38	70	100	885	2	*1
New 39	55.5	43	38	70	100	910	2	*1
40	56.8	43	38	70	100	925	2	*1
41	58	43	38	69	100	970	2	*1
42	59.3	43	38	69	100	990	2	*1
46	64.3	43	38	68	100	1150	2	*1
50	69.2	53	62	-	100	1328	2	*2

*1 C-Ring=C61, Pin/O-Ring=A61/B61

*2 C-Ring=C81, Pin/O-Ring=A62/B62 → P256-257

16301A (inch)	D ₁ (mm)	D ₂ (mm)	H ₁ (mm)	H ₂ (mm)	L (mm)	(g)	(pcs.)	
11/16	28	43	17	74	100	470	2	*1
3/4	30.5	43	19	74	100	480	2	*1
13/16	33	43	21	74	100	505	2	*1
7/8	34.3	43	22	74	100	528	2	*1
15/16	36.8	43	24	74	100	560	2	*1
1	38	43	25	74	100	581	2	*1
1. 1/16	40.5	43	27	73	100	610	2	*1
1. 1/8	43	43	29	73	100	650	2	*1
1. 3/16	44.3	43	30	73	100	670	2	*1
1. 1/4	46.8	43	32	72	100	715	2	*1
1. 5/16	49.3	43	34	72	100	790	2	*1
1. 3/8	50.5	43	35	71	100	785	2	*1
1. 7/16	53	43	37	71	100	850	2	*1
1. 1/2	54.3	43	38	70	100	885	2	*1
1. 9/16	56.8	43	38	70	100	925	2	*1
1. 5/8	58	43	38	69	100	970	2	*1
1.13/16	64.3	43	38	68	100	1150	2	*1

*1 C-Ring=C61, Pin/O-Ring=A61/B61 → P256-257

16305M (mm)	D ₁ (mm)	D ₂ (mm)	H ₁ (mm)	H ₂ (mm)	L (mm)	(g)	(pcs.)	
14	26.3	44	14	74	100	500	2	*1
16	28.8	44	16	74	100	522	2	*1
17	30	44	17	74	100	544	2	*1
18	31.3	44	18	74	100	600	2	*1
19	32.5	44	19	74	100	655	2	*1
21	35	44	21	74	100	700	2	*1
22	36.3	44	22	74	100	700	2	*1
23	37.5	44	23	74	100	720	2	*1
24	38.8	44	24	74	100	715	2	*1
26	41.3	44	26	74	100	760	2	*1
27	42.5	44	27	73	100	765	2	*1
28	43.8	44	28	73	100	800	2	*1
29	45	44	29	73	100	835	2	*1
30	46.3	44	30	73	100	840	2	*1
32	48.8	44	32	72	100	875	2	*1
33	50	44	33	72	100	920	2	*1
34	51.3	44	34	72	100	950	2	*1
35	52.5	44	35	71	100	980	2	*1
36	53.8	44	36	71	100	960	2	*1
38	56.3	44	38	70	100	990	2	*1
41	60	44	38	69	100	1120	2	*1
46	66.3	44	38	68	100	1305	2	*1
50	71.3	54	61	-	100	1469	2	*2

*1 C-Ring=C61, Pin/O-Ring=A61/B61

*2 C-Ring=C81, Pin/O-Ring=A62/B62 → P256-257

16305M

12-point Sockets, deep
12-kant Steckschlüssel, lang
Douilles longues, 12-pans

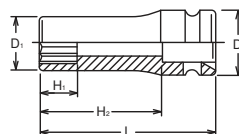

Z-SERIES
HAND
TITANIUM
ACCESSORIES
SCREWDRIVERS
IMPACT
SLEEVE-DRIVE
PROTECTOR
INDUSTRIAL
AUTOMOTIVE
MOTORCYCLE
CONSTRUCTION
SPARE PART

Impact Sockets Impact Steckschlüssel 3/4"

16310M  Surface Drive Sockets, deep
Surface Drive Steckschlüssel, lang
Douilles longues, Surface Drive

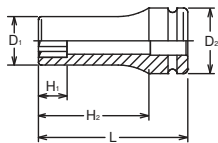

16310M (mm)	D ₁ (mm)	D ₂ (mm)	H ₁ (mm)	H ₂ (mm)	L (mm)	(g)	(pcs.)	
16	28.8	44	16	74	100	524	2	*1
17	30	44	17	74	100	544	2	*1
18	31.3	44	18	74	100	642	2	*1
19	32.5	44	19	74	100	655	2	*1
21	35	44	21	74	100	700	2	*1
22	36.3	44	22	74	100	700	2	*1
24	38.8	44	24	74	100	705	2	*1
27	42.5	44	27	73	100	710	2	*1
30	46.3	44	30	73	100	840	2	*1
32	48.8	44	32	72	100	875	2	*1
33	50	44	33	72	100	920	2	*1
36	53.8	44	34	71	100	960	2	*1

*1 C-Ring=C61, Pin/O-Ring=A61/B61 → P256-257

SURFACE DRIVE

Surface drive sockets are designed to retain contact with the flat sides of the nut in order to transmit higher torque and reduce nut wear. These sockets are ideal for using on polished nuts, aluminum nuts and nuts with worn out points.

Das Profil unserer Surface-Drive Steckschlüssel greift die Schraube an deren Flächen. Dies sichert eine höhere Kraftübertragung und verhindert ein Durchrutschen des Steckschlüssels. Diese Steckschlüssel eignen sich besonders für polierte Schrauben, Aluminium Schrauben und Schrauben bei denen die Ecken bereits abgerundet sind.

Notre profil Surface Drive assure le contact entre la douille et les plats de l'écrou. Ceci réduit l'usure et permet la transmission d'un couple plus élevé. C'est une solution idéale pour les écrous polies, celles en aluminium ou arrondies.

16325  TORX® Deep Sockets
TORX® Steckschlüssel, lang
Douilles longues TORX®

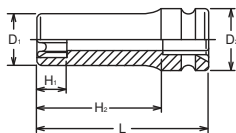

16325 (E)	D ₁ (mm)	D ₂ (mm)	H ₁ (mm)	H ₂ (mm)	L (mm)	(g)	(pcs.)	
E18	26.3	44	13	74	100	520	2	*1
E20	28.8	44	14.4	74	100	560	2	*1
E22	31.3	44	15.5	74	100	600	2	*1
E24	32.5	44	17	74	100	630	2	*1
E26	35.0	44	18.8	74	100	660	2	*1
E28	36.3	44	25.2	74	100	670	2	*1
E30	38.8	44	25.2	75	100	730	2	*1
E32	41.3	44	25.2	75	100	777	2	*1

*1 C-Ring=C61, Pin/O-Ring=A61/B61 → P256-257

TORX® (E)

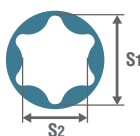

E	E4	E5	E6	E7	E8	E10	E11	E12	E14	E16	E18	E20	E22	E24	E26	E28	E30	E32
S ₁ (ref. mm)	3.7	4.6	5.6	6.1	7.4	9.3	9.9	11.0	12.8	14.6	16.5	18.3	20.1	22.0	23.7	25.5	27.3	29.0
S ₂ (ref. mm)	2.7	3.3	4.0	4.3	5.3	6.8	7.1	7.9	9.2	10.5	11.9	13.2	14.8	15.7	17.5	18.3	20.0	21.3

16106-16 (mm)	D (mm)	H (mm)	L (mm)	(g)	(pcs.)	⚡
10	44	24	76	416	2	*1
12	44	24	76	422	2	*1
13	44	24	76	426	2	*1
14	44	24	76	430	2	*1
16	44	24	76	439	2	*1
17	44	24	76	443	2	*1 ⚠
18	44	24	76	448	2	*1 ⚠
19	44	24	76	450	2	*1 ⚠
22	44	24	76	473	2	*1 ⚠

16106-16 (inch)	D (mm)	H (mm)	L (mm)	(g)	(pcs.)	⚡
1/2	44	24	76	426	2	*1
9/16	44	24	76	430	2	*1
5/8	44	24	76	439	2	*1
3/4	44	24	76	450	2	*1 ⚠

*1 C-Ring=C61, Pin/O-Ring=A61/B61 → P256-257

⚠ The items with ⚠ have larger output size than 16mm input hex drive.
Due to this design the Maximum output torque rating is less than standards.

16106-16 (T)	D (mm)	H (mm)	L (mm)	(g)	(pcs.)	⚡
New T55	44	34	86	427	2	*1
New T60	44	34	86	434	2	*1
New T70	44	34	86	443	2	*1

*1 C-Ring=C61, Pin/O-Ring=A61/B61 → P256-257

16106-16 (XZN)	D (mm)	H (mm)	L (mm)	(g)	(pcs.)	⚡
New M14	44	44	96	453	2	*1
New M16	44	44	96	463	2	*1
New M18	44	44	96	473	2	*1

*1 C-Ring=C61, Pin/O-Ring=A61/B61 → P256-257

16106	D ₁ (mm)	D ₂ (mm)	H (mm)	L (mm)	(g)	(pcs.)	⚡
16106	32	44	16	52	370	2	*1

*1 C-Ring=C61, Pin/O-Ring=A61/B61 → P256-257

16106-SC

Replacement Screw : M6x10, ⚫3mm

16106-16

⚫ Bit Holder complete with Bit, Inhex
Klingenhalter komplett mit Klinge, Innensechskant
Porte embouts avec bit 6-pans creux

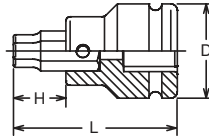

16106-16(T)

⚫ TORX® Bit Sockets
TORX® Bit-Steckschlüssel
Douilles tournevis, TORX®

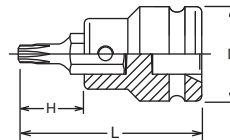

16106-16(XZN)

⚫ XZN Bit Sockets
Steckschlüssel für XZN Schrauben
Douilles tournevis pour empreinte XZN

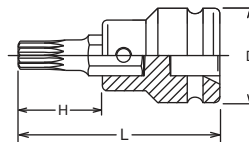

16106

⚫ Bit Holder
Klingenhalter
Porte-embout

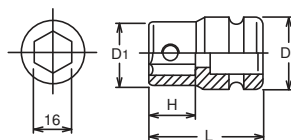

Impact Sockets Impact Steckschlüssel Douilles Impact

3/4"

Z-SERIES
HAND
TITANIUM
SCREWDRIVERS
ACCESSORIES
IMPACT
SLEEVE-DRIVE
PROTECTOR
INDUSTRIAL
AUTOMOTIVE
MOTORCYCLE
CONSTRUCTION
SPARE PART

107-16

Bits for Inhex Screws
Klingen für Innensechskant-Schrauben
Embouts pour vis 6-pans males creux



107-16 (mm)	L (mm)	(g)	(pcs.)
10	40	46	10
12	40	52	10
13	40	56	10
14	40	60	10
16	40	69	10
17	40	73	10
18	40	78	10
19	40	80	10
22	40	97	10

107-16 (inch)	L (mm)	(g)	(pcs.)
3/8	40	45	10
7/16	40	53	10
1/2	40	56	10
9/16	40	60	10
5/8	40	69	10
3/4	40	80	10

107-16(L100) (mm)	L (mm)	R (mm)	(g)	(pcs.)
10	100	13	118	10
12	100	15	141	10
14	100	-	163	10
17	100	-	185	10
19	100	-	228	10
22	100	-	293	10

The items with have larger output size than 16mm input hex drive. Due to this design the Maximum output torque rating is less than standards.

107-16 (T)

TORX® Bits
TORX® Klingen
Embouts, TORX®

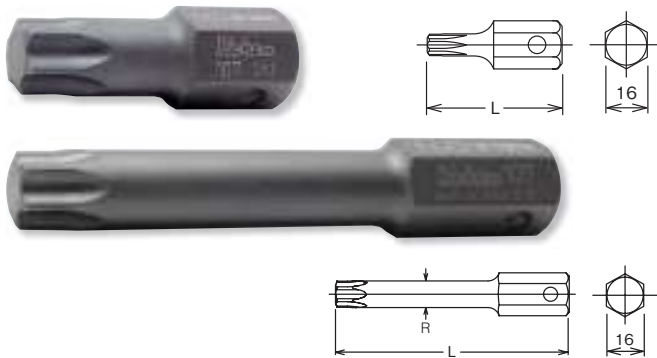

107-16 (T)	L (mm)	(g)	(pcs.)
T45	50	45	10
T50	50	50	10
T55	50	57	10
T60	50	64	10
T70	50	73	10

107-16(L100) (T)	L (mm)	R (mm)	(g)	(pcs.)
T45	100	8	95	10
T50	100	9	100	10
T55	100	11.4	104	10
T60	100	13.4	123	10
T70	100	15.7	148	10

107-16 (IP)

TORXPLUS® Bits
TORXPLUS® Klingen
Embouts TORXPLUS®



107-16 (IP)	L (mm)	(g)	(pcs.)
55IP	50	57	10
60IP	50	64	10
70IP	50	73	10

107-16 (XZN)

Bits XZN
Klingen XZN
Embouts de vissage, XZN



107-16 (XZN)	L (mm)	(g)	(pcs.)
M14	60	83	10
M16	60	93	10
M18	60	103	10

107-16(L100) (XZN)	L (mm)	R (mm)	(g)	(pcs.)
M14	100	13.4	126	10
M16	100	15.8	153	10
M18	100	17.1	173	10

16107-22 (mm)	D (mm)	H (mm)	L (mm)	(g)	(pcs.)	⚡
19	44	28	88	670	2	*1
22	44	28	88	692	2	*1
24	44	28	88	706	2	*1
27	44	28	88	730	2	*1
30	44	28	88	757	2	*1
32	44	28	93	783	2	*1

*1 C-Ring=C61, Pin/O-Ring=A61/B61 → P256-257

16107	D ₁ (mm)	D ₂ (mm)	H (mm)	L (mm)	(g)	(pcs.)	⚡
16107	44	44	22	60	530	2	*1

*1 C-Ring=C61, Pin/O-Ring=A61/B61 → P256-257

16107-SC

Replacement Screw : M8x14, ●4mm

107-22 (mm)	L (mm)	(g)	(pcs.)
17	50	120	10
19	50	140	10
22	50	162	10
24	50	176	10
27	50	200	10
30	50	227	10
32	55	243	10

107-22 (inch)	L (mm)	(g)	(pcs.)
5/8	50	120	10
3/4	50	140	10
7/8	50	162	10
1	50	190	10
1. 1/4	55	243	10

107-22(L140) (mm)	L (mm)	(g)	(pcs.)
New 17	140	431	5
New 19	140	441	5
New 22	140	460	5
New 24	140	513	5

107-22 (T)	L (mm)	(g)	(pcs.)
T 70	60	129	10
T 80	60	141	10
T 90	60	155	10
T100	60	170	10

107-22(L140) (T)	L (mm)	(g)	(pcs.)
New T 70	140	395	5
New T 80	140	407	5
New T 90	140	420	5
New T100	140	434	5

16107-22

Bit Holder complete with Bit
Klinghalter, komplett mit Klinge
Porte embouts avec bit

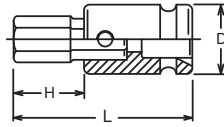

16107

Bit Holder
Klinghalter
Porte embouts

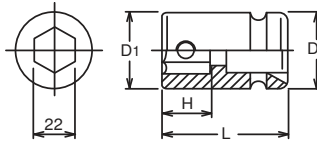

107-22

Bits for Inhex Screws
Klingen für Innensechskant-Schrauben
Embouts pour vis 6-pans males creux

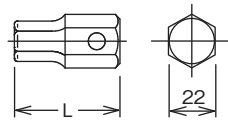

107-22 (T)

TORX® Bits
TORX® Klingen
Embouts, TORX®

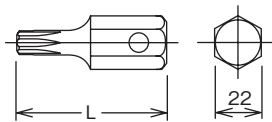

16760

Extension Bars
Verlängerungen
Rallonges

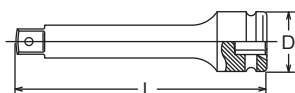

16760-150	D (mm)	L (mm)	(g)	(pcs.)	⚡
16760-150	44	150	775	1	*1
16760-175	44	175	870	1	*1
16760-200	44	200	955	1	*1
16760-250	44	250	1150	1	*1
16760-330	44	330	1460	1	*1

*1 C-Ring=C61, Pin/O-Ring=A61/B61 → P256-257

⚠ The items with ⚠ have larger output size than 22mm input hex drive.
Due to this design the Maximum output torque rating is less than standards.

Impact Sockets Impact Steckschlüssel Douilles Impact

3/4"

Z-SERIES
HAND
TITANIUM
SCREWDRIVERS ACCESSORIES
IMPACT
SLEEVE-DRIVE
PROTECTOR
INDUSTRIAL
AUTOMOTIVE
MOTORCYCLE
CONSTRUCTION
SPARE PART

16666AL Adaptor (Quick Release)
Verbindungsstück (Quick Release)
Adaptateur (Quick Release) ⚠

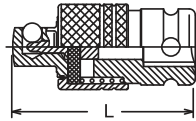

	L (mm)	(g)	(pcs.)	
16666AL	75	660	2	*1

*1 C-Ring=C61, Pin/O-Ring=A61/B61 → P256-257

Lock & Quick Release

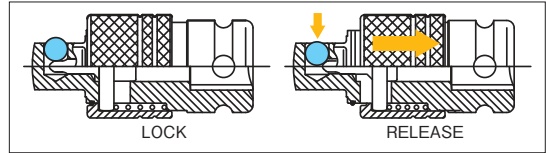

⚠ You may not hold the sliding part while moving to avoid heating up by friction and reduction by wear.

16644AL Adaptor (Quick Release)
Adaptador (Extracción Rápida) No Warranty
Sin Garantía ⚠

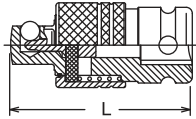

	(sq.)	(sq.)	L (mm)	(g)	(pcs.)	
16644AL	3/4"	1/2"	70	240	2	*1

*1 Pin/O-Ring=A51/B51 → P257

⚠ Adapting down from bigger square drive to smaller square drive may lead to excessive torque load and possibly cause breakage. Always stay within safe torque of the smaller square drive.

16770 Universal Joint
Gelenk-Einsatz
Joint articulé

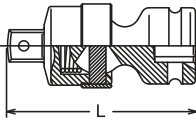

	L (mm)	(g)	(pce.)	
16770	106	790	1	*1
16771	95	720	1	*1

*1 C-Ring=C61, Pin/O-Ring=A61/B61 → P256-257

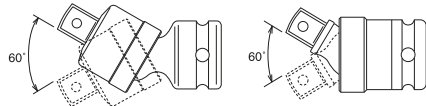

Our ball joints are spring-loaded and can therefore be adjusted to an angle of max. 30°.

Unsere Kugelgelenke sind federbelastet dadurch sind sie auf einen Winkel von max 30° einstellbar.

Nos joints à rotule sont à ressort et peuvent donc être réglés jusqu'à un angle de 30° maximum.

16771 Universal Joint
Gelenk-Einsatz
Joint articulé

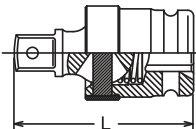

16644A-P Adaptors
Verbindungsstücke
Réducteurs No Warranty
Keine Garantie
Sans Garantie ⚠

16644A
16655A

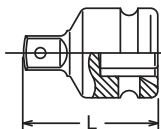

	TYPE	(sq.)	(sq.)	L (mm)	(g)	(pcs.)	
16644A-P	Pin	3/4"	1/2"	54	310	5	*1
16644A	Hole	3/4"	1/2"	54	310	5	*1

	(sq.)	(sq.)	L (mm)	(g)	(pce.)	
16655A	3/4"	5/8"	55.5	336	5	*1

*1 C-Ring=C61, Pin/O-Ring=A61/B61 → P256-257

⚠ Adapting down from bigger square drive to smaller square drive may lead to excessive torque load and possibly cause breakage. Always stay within safe torque of the smaller square drive.

Die mit ⚠ gekennzeichneten Artikel können bei Überbelastung zu Bruch gehen. Aus Gründen Ihrer eigenen Sicherheit sollten die betreffenden Werkzeuge nie ruckartig, sondern nach und nach belastet werden, um Bruch und damit verbundene mögliche Verletzungen zu vermeiden.

Il est possible d'appliquer aux articles marqués ⚠ des couples de serrage susceptibles d'occasionner leur rupture. Pour votre propre sécurité, veuillez toujours appliquer la charge d'une manière uniforme et progressive. Ceci pour éviter ruptures et accidents.

16688A Adaptor
Verbindungsstück
Augmentateur

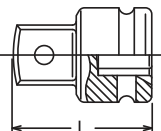

	(sq.)	(sq.)	L (mm)	(g)	(pce.)	
16688A	3/4"	1"	62	435	1	*1
16688A-250	3/4"	1"	250	1400	1	*1
16688A-330	3/4"	1"	330	1880	1	*1

*1 C-Ring=C61, Pin/O-Ring=A61/B61 → P256-257

16688A-250 / -330 Adaptors
Verbindungsstücke
Réducteurs



3/4"

Impact Sockets
Impact Steckschlüssel
Douilles Impact

16201M-00 / 16201A-00

Socket Sets
Steckschlüssel Sätze
Jeux de clés à douilles



16201M-00	13 Pieces Set/△=6,800g
METAL CASE:W320×H110×T70mm	
Sockets	
16400M 6-pt. Sockets 19, 21, 22, 23, 24, 26, 27, 30, 32, 33, 36, 38, 41	

16201A-00	11 Pieces Set/△=6,000g
METAL CASE:W290×H120×T70mm	
Sockets	
16400A 6-pt. Sockets 3/4, 7/8, 15/16, 1, 1.1/16, 1.1/8, 1.1/4, 1.5/16, 1.3/8, 1.7/16, 1.1/2	

16201M-01 / 16201A-01

Socket Sets
Steckschlüssel Sätze
Jeux de clés à douilles



16201M-01	13 Pieces Set/△=6,000g
METAL CASE:W320×H110×T70mm	
Sockets	
16401M 6-pt. Sockets, Thin-walled 19, 21, 22, 23, 24, 26, 27, 30, 32, 33, 36, 38, 41	

16201A-01	11 Pieces Set/△=5,400g
METAL CASE:W290×H120×T70mm	
Sockets	
16401A 6-pt. Sockets, Thin-walled 3/4, 7/8, 15/16, 1, 1.1/16, 1.1/8, 1.1/4, 1.5/16, 1.3/8, 1.7/16, 1.1/2	

16245M

Socket Sets
Steckschlüssel Sätze
Jeux de clés à douilles

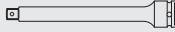

16245M	17 Pieces Set/△=12,000g
METAL CASE:W590×H127×T72mm	
Sockets	Accessories
16400M 6-pt. Sockets 19, 21, 22, 24, 27, 29, 30, 32, 33, 35, 36, 38, 41, 46, 50	 16760-175  16760-330

Z-SERIES
HAND
TITANIUM
ACCESSORIES
SCREWDRIVERS
IMPACT
SLEEVE-DRIVE
PROTECTOR
INDUSTRIAL
AUTOMOTIVE
MOTORCYCLE
CONSTRUCTION
SPARE PART

Impact Sockets Impact Steckschlüssel Douilles Impact

1"

18400M / 18400A

6-point Sockets
6-kant Steckschlüssel
Douilles 6-pans

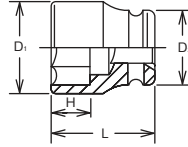

Z-SERIES
HAND
TITANIUM
ACCESSORIES
SCREWDRIVERS
IMPACT
SLEEVE-DRIVE
PROTECTOR
INDUSTRIAL
AUTOMOTIVE
MOTORCYCLE
CONSTRUCTION
SPARE PART

18400M (mm)	D ₁ (mm)	D ₂ (mm)	H (mm)	L (mm)	(g)	(pcs.)	⊕
17	32.8	54	12	57	579	2	*1
18	34	54	13	57	586	2	*1
19	35.3	54	13	57	590	2	*1
New 20	36.5	54	14	57	600	2	*1
21	37.8	54	15	57	605	2	*1
22	39	54	15	57	620	2	*1
23	40.3	54	16	57	615	2	*1
24	41.5	54	16	57	627	2	*1
25	42.8	54	16	57	620	2	*1
26	44	54	16	57	640	2	*1
27	45.3	54	16	57	627	2	*1
28	46.5	54	16	57	640	2	*1
29	47.8	54	18	57	657	2	*1
30	49	54	21	62	657	2	*1
31	50.3	54	21	62	687	2	*1
32	51.5	54	21	62	685	2	*1
33	52.8	54	21	62	685	2	*1
34	54	54	21	62	690	2	*1
35	55.3	54	21	62	710	2	*1
36	56.5	54	21	62	712	2	*1
37	57.8	54	21	62	735	2	*1
38	59	54	25	66	720	2	*1
39	60.3	54	25	66	820	2	*1
40	61.5	54	25	66	850	2	*1
41	62.8	54	25	66	850	2	*1
42	64	54	25	66	905	2	*1
43	65.3	54	27	68	977	2	*1
44	66.5	54	27	68	970	2	*1
45	67.8	54	27	68	963	2	*1
46	69	54	29	70	1010	2	*1
47	70.3	66	36	70	1235	2	*2
48	71.5	66	35	70	1228	2	*2
50	74	66	35	70	1302	2	*2
52	76.5	66	40	75	1423	2	*2
54	79	66	40	75	1492	2	*2
55	80.3	66	39	75	1501	2	*2
56	81.5	66	39	75	1520	2	*2
58	84	66	39	75	1586	2	*2
60	86.5	66	39	75	1651	2	*2
62	89	66	38	75	1685	2	*2
63	90.3	66	38	75	1661	2	*2
65	92.8	66	38	75	1915	2	*2
67	95.3	66	38	75	1872	2	*2
68	96.5	66	37	75	1877	1	*2
70	99	66	37	75	1944	1	*2
75	105.3	86	37	80	2675	1	*3
77	107.8	86	37	80	2890	1	*3
80	111.5	86	41	85	2996	1	*3
85	117.8	86	37	90	3378	1	*3
90	124	86	40	95	3871	1	*3
95	130.3	86	43	100	4500	1	*3
100	136.5	86	47	105	5000	1	*3

18400A (inch)	D ₁ (mm)	D ₂ (mm)	H (mm)	L (mm)	(g)	(pcs.)	⊕
11/16	32.8	54	12	57	579	2	*1
3/4	35.3	54	13	57	590	2	*1
13/16	37.8	54	15	57	605	2	*1
7/8	39	54	15	57	620	2	*1
15/16	41.5	54	16	57	627	2	*1
1	42.8	54	16	57	620	2	*1
1. 1/16	45.3	54	16	57	627	2	*1
1. 3/32	46.5	54	16	57	640	2	*1
1. 1/8	47.8	54	18	57	657	2	*1
1. 3/16	49	54	21	62	657	2	*1
1. 1/4	51.5	54	21	62	685	2	*1
1. 5/16	54	54	21	62	690	2	*1
1. 3/8	55.3	54	21	62	710	2	*1
1. 7/16	57.8	54	21	62	735	2	*1
New 1.15/32	57.8	62	21	62	735	2	*1
1. 1/2	59	54	25	66	720	2	*1
1. 9/16	61.5	54	25	66	850	2	*1
1. 5/8	62.8	54	25	66	850	2	*1
1.11/16	65.3	54	27	68	977	2	*1
1. 3/4	67.8	54	27	68	963	2	*1
1.13/16	69	54	29	70	1010	2	*1
1. 7/8	71.5	66	35	70	1228	2	*2
1.15/16	72.8	66	35	70	1238	2	*2
2	75.3	66	35	70	1297	2	*2
2. 1/16	76.5	66	40	75	1423	2	*2
2. 1/8	79	66	40	75	1492	2	*2
2. 3/16	80.3	66	39	75	1501	2	*2
2. 1/4	82.8	66	39	75	1583	2	*2
2. 5/16	84	66	39	75	1586	2	*2
2. 3/8	86.5	66	39	75	1651	2	*2
2. 7/16	89	66	38	75	1685	2	*2
2. 1/2	91.5	66	38	75	1780	2	*2
2. 9/16	92.8	66	38	75	1915	2	*2
2. 5/8	95.3	66	38	75	1872	2	*2
2.11/16	96.5	66	37	75	1877	1	*2
2. 3/4	99	66	37	75	1944	1	*2
2.13/16	101.5	86	37	80	2705	1	*3
2. 7/8	102.8	86	38	80	2629	1	*3
2.15/16	105.3	86	37	80	2675	1	*3
3	106.5	86	37	80	2705	1	*3
3. 1/16	109	86	42	85	2967	1	*3
3. 1/8	111.5	86	41	85	2996	1	*3
3. 1/4	115.3	86	44	90	3328	1	*3
3. 3/8	119	86	36	90	3389	1	*3
3. 1/2	124	86	40	95	3871	1	*3
3. 3/4	130.3	86	43	100	4377	1	*3
3. 7/8	135.3	86	47	105	5000	1	*3
4	137.8	86	46	105	5152	1	*3

*1 C-Ring=C81, Pin/O-Ring=A81/B81
 *2 C-Ring=C82, Pin/O-Ring=A82/B82
 *3 C-Ring=C83, Pin/O-Ring=A83/B83

*1 C-Ring=C81, Pin/O-Ring=A81/B81
 *2 C-Ring=C82, Pin/O-Ring=A82/B82
 *3 C-Ring=C83, Pin/O-Ring=A83/B83

18405M (mm)	D ₁ (mm)	D ₂ (mm)	H (mm)	L (mm)	(g)	(pcs.)	
24	41.5	54	16	57	627	2	*1
27	45.3	54	16	57	607	2	*1
30	49	54	21	62	657	2	*1
32	51.5	54	21	62	685	2	*1
33	52.8	54	21	62	690	2	*1
35	55.3	54	21	62	690	2	*1
36	56.5	54	21	62	692	2	*1
38	59	54	25	66	700	2	*1
40	61.5	54	25	66	830	2	*1
41	62.8	54	25	66	905	2	*1
46	69	54	29	70	990	2	*1
50	74	66	35	70	1258	2	*2
55	80.3	66	39	75	1475	2	*2
56	81.5	66	39	75	1493	2	*2
60	86.5	66	39	75	1621	2	*2
65	92.8	66	38	75	1885	2	*2
70	99	66	37	75	1960	1	*2
75	105.3	86	37	80	2675	1	*3
80	111.5	86	41	85	2996	1	*3

18405A (inch)	D ₁ (mm)	D ₂ (mm)	H (mm)	L (mm)	(g)	(pcs.)	
3/4	35.3	54	13	57	590	2	*1
7/8	39	54	15	57	620	2	*1
1	42.8	54	16	57	620	2	*1
1. 1/8	47.8	54	18	57	660	2	*1
1. 3/16	49	54	21	62	660	2	*1
1. 1/4	51.5	54	21	62	690	2	*1
1. 3/8	55.3	54	21	62	710	2	*1
1. 7/16	57.8	54	21	62	735	2	*1
1. 1/2	59	54	25	66	720	2	*1
1. 3/4	67.8	54	27	68	970	2	*1
1.15/16	72.8	66	35	70	1208	2	*1

*1 C-Ring=C81, Pin/O-Ring=A81/B81

*2 C-Ring=C82, Pin/O-Ring=A82/B82

*3 C-Ring=C83, Pin/O-Ring=A83/B83

→ P256-257

18405M / 18405A

12-point Sockets
12-kant Steckschlüssel
Douilles 12-pans

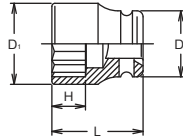

18401M (mm)	D ₁ (mm)	D ₂ (mm)	H (mm)	L (mm)	(g)	(pcs.)	
17	29.8	53	12	57	481	2	*1
18	31	53	13	57	488	2	*1
19	32.3	53	13	57	492	2	*1
20	33.5	53	14	57	505	2	*1
21	34.8	53	15	57	512	2	*1
22	36	53	15	57	520	2	*1
24	38.5	53	16	57	520	2	*1
26	41	53	16	57	533	2	*1
27	42.3	53	16	57	540	2	*1
29	44.8	53	18	57	560	2	*1
30	46	53	21	62	572	2	*1
32	48.5	53	21	62	600	2	*1
33	49.8	53	21	62	613	2	*1
35	52.3	53	21	62	630	2	*1
36	53.5	53	21	62	635	2	*1
38	56	53	25	66	705	2	*1
41	59.8	53	25	66	740	2	*1
42	61	53	25	66	803	2	*1
46	66	53	29	70	900	2	*1
47	67.3	65	36	70	1153	2	*2
50	71	65	35	70	1235	2	*2

18401A (inch)	D ₁ (mm)	D ₂ (mm)	H (mm)	L (mm)	(g)	(pcs.)	
11/16	29.8	53	12	57	481	2	*1
3/4	32.3	53	13	57	492	2	*1
13/16	34.8	53	15	57	512	2	*1
7/8	36	53	15	57	520	2	*1
15/16	38.5	53	16	57	520	2	*1
1. 1/16	42.3	53	16	57	540	2	*1
1. 3/16	46	53	21	62	572	2	*1
1. 1/4	48.5	53	21	62	600	2	*1
1. 3/8	52.3	53	21	62	630	2	*1
1. 1/2	56	53	25	66	705	2	*1
1. 5/8	59.8	53	25	66	740	2	*1
1.13/16	66	53	29	70	900	2	*1

*1 C-Ring=C81, Pin/O-Ring=A81/B81

*2 C-Ring=C82, Pin/O-Ring=A82/B82

→ P256-257

18401M / 18401A

6-point Sockets, Thin Walled
6-kant Steckschlüssel, dünnwandig
Douilles à paroi mince, 6-pans

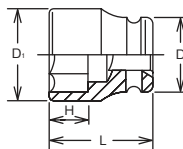

Impact Sockets Impact Steckschlüssel Douilles Impact

1"

Z-SERIES
HAND
TITANIUM
SCREWDRIVERS
ACCESSORIES
IMPACT
SLEEVE-DRIVE
PROTECTOR
INDUSTRIAL
AUTOMOTIVE
MOTORCYCLE
CONSTRUCTION
SPARE PART

18410M



Surface Drive Sockets
Surface Drive Steckschlüssel
Douilles, Surface Drive

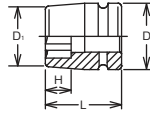

18410M (mm)	D ₁ (mm)	D ₂ (mm)	H (mm)	L (mm)	(g)	(pcs.)	
New 19	35.3	54	13	57	570	2	*1
New 22	39	54	15	57	620	2	*1
24	41.5	54	16	57	627	2	*1
27	45.3	54	16	57	627	2	*1
30	49	54	21	62	657	2	*1
32	51.5	54	21	62	685	2	*1
33	52.8	54	21	62	685	2	*1
36	56.5	54	21	62	712	2	*1
41	62.8	54	25	66	850	2	*1

*1 C-Ring=C81, Pin/O-Ring=A81/B81 → P256-257

18405M (D)



Sockets for Cardan Shafts
Steckschlüssel für Gelenkwellen
Douilles pour arbres à cardan

No Warranty
Keine Garantie
Sans Garantie

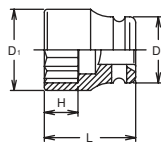

18405M (D) (mm)	D ₁ (mm)	D ₂ (mm)	H (mm)	L (mm)	(g)	(pcs.)	
50(D68)	68	66	35	70	890	2	*2
55(D76)	76	66	39	75	1130	2	*2
65(D87)	87	66	38	75	1344	2	*2

*2 C-Ring=C82, Pin/O-Ring=A82/B82 → P256-257

Items in this catalogue marked can be loaded to torque values which may cause breakage. In the interest of your own safety always apply load evenly and progressively to avoid breakage and possible injury.

Die mit gekennzeichneten Artikel können bei Überbelastung zu Bruch gehen. Aus Gründen Ihrer eigenen Sicherheit sollten die betreffenden Werkzeuge nie ruckartig, sondern nach und nach belastet werden, um Bruch und damit verbundene mögliche Verletzungen zu vermeiden.

Il est possible d'appliquer aux articles marqués des couples de serrage susceptibles d'occasionner leur rupture. Pour votre propre sécurité, veuillez toujours appliquer la charge d'une manière uniforme et progressive. Ceci pour éviter ruptures et accidents.



18301X (mm)	D ₁ (mm)	D ₂ (mm)	H ₁ (mm)	H ₂ (mm)	L (mm)	⚖️ (g)	📦 (pcs.)	⚡
17	29.8	53	17	48	80	635	2	*1
19	32.3	53	19	48	80	655	2	*1
21	34.8	53	21	48	80	680	2	*1
22	36	53	22	48	80	686	2	*1
24	38.5	53	24	48	80	693	2	*1
27	42.3	53	27	48	80	745	2	*1
30	46	53	30	48	80	761	2	*1
32	48.5	53	32	53	85	770	2	*1
33	49.8	53	33	53	85	781	2	*1
35	52.3	53	35	53	85	800	2	*1
36	53.5	53	36	52	85	808	2	*1
38	56	53	38	52	85	865	2	*1
41	59.8	53	38	51	85	937	2	*1
46	66	53	38	50	85	1032	2	*1
50	71	65	55	-	85	1458	2	*2



18301X

6-point Semi-Deep Sockets, Thin Walled
6-kant Steckschlüssel mittel lang, dünnwandig
Douilles à paroi mince semi-longues, 6-pans

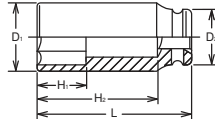

*1 C-Ring=C81, Pin/O-Ring=A81/B81
*2 C-Ring=C82, Pin/O-Ring=A82/B82 → P256-257

18300M / 18300A

6-point Sockets, deep
6-kant Steckschlüssel, lang
Douilles 6-pans, longues



18300M (mm)	D ₁ (mm)	D ₂ (mm)	H ₁ (mm)	H ₂ (mm)	L (mm)	⚖️ (g)	📦 (pcs.)	⚡
17	32.8	54	17	77	108	1000	2	*1
19	35.3	54	19	77	108	1010	2	*1
20	36.5	54	20	77	108	1010	2	*1
21	37.8	54	21	77	108	1010	2	*1
22	39	54	22	77	108	1010	2	*1
23	40.3	54	23	77	108	1063	2	*1
24	41.5	54	24	77	108	1060	2	*1
25	42.8	54	25	77	108	1085	2	*1
26	44	54	26	77	108	1133	2	*1
27	45.3	54	27	77	108	1125	2	*1
28	46.5	54	28	77	108	1140	2	*1
29	47.8	54	29	77	108	1120	2	*1
30	49	54	30	77	108	1179	2	*1
31	50.3	54	31	77	108	1125	2	*1
32	51.5	54	32	77	108	1200	2	*1
33	52.8	54	33	77	108	1200	2	*1
34	54	54	34	77	108	1280	2	*1
35	55.3	54	35	77	108	1300	2	*1
36	56.5	54	36	76	108	1280	2	*1
37	57.8	54	37	76	108	1320	2	*1
38	59	54	38	76	108	1423	2	*1
40	61.5	54	38	75	108	1415	2	*1
41	62.8	54	38	75	108	1450	2	*1
42	64	54	38	75	108	1550	2	*1
44	66.5	54	38	74	108	1636	2	*1
45	67.8	54	38	74	108	1660	2	*1
46	69	54	38	74	108	1680	2	*1
48	71.5	66	67	-	108	1729	2	*2
50	74	66	66	-	108	1879	2	*2
52	76.5	66	65	-	108	2000	2	*2
55	80.3	66	63	-	108	2088	2	*2
60	86.5	66	60	-	108	2290	2	*2
65	92.8	66	58	-	108	2643	2	*2
70	99	66	55	-	108	2792	1	*2
75	105.3	86	52	-	108	3646	1	*3
80	111.5	86	49	-	108	4039	1	*3
85	117.8	86	59	-	108	4000	1	*3
90	124	86	57	-	108	4200	1	*3
95	130.3	86	55	-	108	4400	1	*3

18300A (inch)	D ₁ (mm)	D ₂ (mm)	H ₁ (mm)	H ₂ (mm)	L (mm)	⚖️ (g)	📦 (pcs.)	⚡
11/16	32.8	54	17	77	108	978	2	*1
3/4	35.3	54	19	77	108	1010	2	*1
7/8	39	54	22	77	108	1010	2	*1
15/16	41.5	54	24	77	108	1060	2	*1
1	42.8	54	25	77	108	1085	2	*1
1. 1/16	45.3	54	27	77	108	1125	2	*1
1. 1/8	47.8	54	29	77	108	1120	2	*1
1. 3/16	49	54	30	77	108	1179	2	*1
1. 1/4	51.5	54	32	77	108	1200	2	*1
1. 5/16	54	54	34	77	108	1280	2	*1
1. 3/8	55.3	54	35	77	108	1300	2	*1
1. 7/16	57.8	54	37	76	108	1320	2	*1
1. 1/2	59	54	38	76	108	1423	2	*1
1. 9/16	61.5	54	38	75	108	1415	2	*1
1. 5/8	62.8	54	38	75	108	1450	2	*1
1.11/16	65.3	54	38	74	108	1577	2	*1
1. 3/4	67.8	54	38	74	108	1660	2	*1
1.13/16	69	54	38	74	108	1680	2	*1
1. 7/8	71.5	66	67	-	108	1729	2	*2
1.15/16	72.8	66	67	-	108	1799	2	*2
2	75.3	66	66	-	108	1834	2	*2
2. 1/16	76.5	66	65	-	108	2000	2	*2
2. 1/8	79	66	64	-	108	2044	2	*2
2. 3/16	80.3	66	63	-	108	2088	2	*2
2. 1/4	82.8	66	62	-	108	2153	2	*2
2. 5/16	84	66	61	-	108	2225	2	*2
2. 3/8	86.5	66	60	-	108	2290	2	*2
2. 7/16	89	66	59	-	108	2364	2	*2
2. 1/2	91.5	66	58	-	108	2581	2	*2
2. 9/16	92.8	66	58	-	108	2643	2	*2
2. 5/8	95.3	66	56	-	108	2711	1	*2
2. 3/4	99	66	55	-	108	2792	1	*2
2. 7/8	102.8	86	53	-	108	3600	1	*3
2.15/16	105.3	86	52	-	108	3646	1	*3
3	106.5	86	51	-	108	3677	1	*3
3. 1/16	109	86	50	-	108	3939	1	*3
3. 1/8	111.5	86	49	-	108	4039	1	*3
3. 3/16	112.8	86	48	-	108	4170	1	*3

*1 C-Ring=C81, Pin/O-Ring=A81/B81
*2 C-Ring=C82, Pin/O-Ring=A82/B82 → P256-257
*3 C-Ring=C83, Pin/O-Ring=A83/B83

*1 C-Ring=C81, Pin/O-Ring=A81/B81
*2 C-Ring=C82, Pin/O-Ring=A82/B82 → P256-257
*3 C-Ring=C83, Pin/O-Ring=A83/B83

Impact Sockets Impact Steckschlüssel Douilles Impact

1"

Z-SERIES
HAND
TITANIUM
SCREWDRIVERS ACCESSORIES
IMPACT
SLEEVE-DRIVE
PROTECTOR
INDUSTRIAL
AUTOMOTIVE
MOTORCYCLE
CONSTRUCTION
SPARE PART

18301M / 18301A

6-point Deep Sockets, Thin Walled
6-kant Steckschlüssel, dünnwandig
Douilles à paroi mince longues, 6-pans

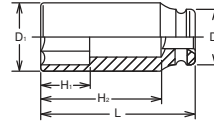

18301A (inch)	D ₁ (mm)	D ₂ (mm)	H ₁ (mm)	H ₂ (mm)	L (mm)	(g)	(pcs.)	
11/16	29.8	53	17	77	108	692	2	*1
3/4	32.3	53	19	77	108	725	2	*1
13/16	34.8	53	21	77	108	750	2	*1
7/8	36	53	22	77	108	770	2	*1
15/16	38.5	53	24	77	108	800	2	*1
1	39.8	53	25	77	108	828	2	*1
1. 1/16	42.3	53	27	77	108	860	2	*1
1. 1/8	44.8	53	29	77	108	909	2	*1
1. 3/16	46	53	30	77	108	910	2	*1
1. 1/4	48.5	53	32	77	108	970	2	*1
1. 9/32	49.8	53	33	77	108	980	2	*1
1. 5/16	51	53	34	77	108	1014	2	*1
1. 3/8	52.3	53	35	77	108	986	2	*1
1. 7/16	54.8	53	37	76	108	1000	2	*1
1. 1/2	56	53	38	76	108	1025	2	*1
1. 9/16	58.5	53	38	75	108	1200	2	*1
1. 5/8	59.8	53	38	75	108	1213	2	*1
1.11/16	62.3	53	38	74	108	1285	2	*1
1. 3/4	64.8	53	38	74	108	1360	2	*1
1.13/16	66	53	38	74	108	1400	2	*1
2	72.3	65	65	-	108	1850	2	*2

*1 C-Ring=C81, Pin/O-Ring=A81/B81
*2 C-Ring=C82, Pin/O-Ring=A82/B82

→ P256-257

18301M (mm)	D ₁ (mm)	D ₂ (mm)	H ₁ (mm)	H ₂ (mm)	L (mm)	(g)	(pcs.)	
17	29.8	53	17	77	108	692	2	*1
18	31	53	18	77	108	710	2	*1
19	32.3	53	19	77	108	725	2	*1
20	33.5	53	20	77	108	740	2	*1
21	34.8	53	21	77	108	750	2	*1
22	36	53	22	77	108	770	2	*1
23	37.3	53	23	77	108	780	2	*1
24	38.5	53	24	77	108	800	2	*1
26	41	53	26	77	108	830	2	*1
27	42.3	53	27	77	108	860	2	*1
29	44.8	53	29	77	108	880	2	*1
30	46	53	30	77	108	910	2	*1
32	48.5	53	32	77	108	970	2	*1
33	49.8	53	33	77	108	980	2	*1
34	51	53	34	77	108	980	2	*1
35	52.3	53	35	77	108	986	2	*1
36	53.5	53	36	76	108	992	2	*1
38	56	53	38	76	108	1025	2	*1
39	57.3	53	38	76	108	1130	2	*1
41	59.8	53	38	75	108	1213	2	*1
42	61	53	38	75	108	1245	2	*1
43	62.3	53	38	74	108	1400	2	*1
46	66	53	38	74	108	1400	2	*1
50	71	65	38	-	108	1746	2	*2
55	77.3	65	62	-	108	1963	2	*2
60	83.5	65	59	-	108	2220	2	*2
65	89.8	65	56	-	108	2689	2	*2
70	96	65	55	-	108	2630	1	*2

*1 C-Ring=C81, Pin/O-Ring=A81/B81 → P256-257

*2 C-Ring=C82, Pin/O-Ring=A82/B82

18104M

Special Sockets for Spring Clamps
Steckschlüssel für Federbriden
Douilles pour brides de ressorts

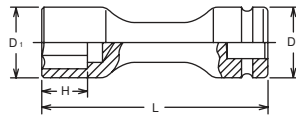

18104M (mm)	D ₁ (mm)	D ₂ (mm)	H (mm)	L (mm)	(g)	(pcs.)	
24	41.5	54	24	170	1327	1	*1
27	45.3	54	27	170	1375	1	*1
28	46.5	54	28	170	1390	1	*1
30	49	54	30	170	1407	1	*1
32	51.5	54	32	170	1537	1	*1
33	52.8	54	33	170	1590	1	*1
34	54	54	34	170	1670	1	*1
36	56.5	54	36	170	1800	1	*1

*1 C-Ring=C81, Pin/O-Ring=A81/B81 → P256-257

18310M

Surface Drive Sockets, deep
Surface Drive Steckschlüssel, lang
Douilles longues, Surface Drive

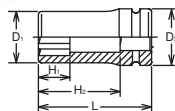

18310M (mm)	D ₁ (mm)	D ₂ (mm)	H ₁ (mm)	H ₂ (mm)	L (mm)	(g)	(pcs.)	
21	37.8	54	21	77	108	1010	2	*1
24	41.5	54	24	77	108	1060	2	*1
27	45.3	54	27	77	108	1125	2	*1
30	49	54	30	77	108	1179	2	*1
32	51.5	54	32	77	108	1200	2	*1
33	52.8	54	33	77	108	1200	2	*1
36	56.5	54	36	76	108	1280	2	*1
41	62.8	54	38	75	108	1450	2	*1

*1 C-Ring=C81, Pin/O-Ring=A81/B81 → P256-257

18106-16 (mm)	D (mm)	H (mm)	L (mm)	(g)	(pcs.)	
10	54	24	92	686	2	*1
12	54	24	92	692	2	*1
13	54	24	92	696	2	*1
14	54	24	92	700	2	*1
16	54	24	92	709	2	*1
17	54	24	92	713	2	*1
18	54	24	92	718	2	*1
19	54	24	92	764	2	*1
22	54	24	92	781	2	*1

18106-16 (inch)	D (mm)	H (mm)	L (mm)	(g)	(pcs.)	
1/2	54	24	92	696	2	*1
9/16	54	24	92	700	2	*1
5/8	54	24	92	709	2	*1
3/4	54	24	92	764	2	*1

*1 C-Ring=C81, Pin/O-Ring=A81/B81 → P256-257

⚠ The items with ⚠ have larger output size than 16mm input hex drive.
Due to this design the Maximum output torque rating is less than standards.

18106-16



Bit Holder complete with Bit, Inhex
Klingenhalter komplett mit Klinge, Innensechskant
Porte embouts avec bit 6-pans creux

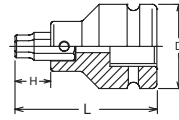

18106-16(T)



TORX® Bit Sockets
TORX® Bit-Steckschlüssel
Douilles tournevis, TORX®

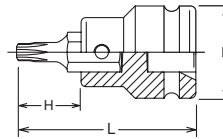

18106-16(XZN)



XZN Bit Sockets
Steckschlüssel für XZN Schrauben
Douilles tournevis pour empreinte XZN

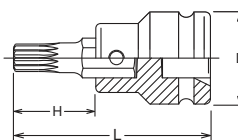

18106-16 (XZN)	D (mm)	H (mm)	L (mm)	(g)	(pcs.)	
New M14	54	44	112	723	2	*1
New M16	54	44	112	733	2	*1
New M18	54	44	112	743	2	*1

*1 C-Ring=C81, Pin/O-Ring=A81/B81 → P256-257

18106	D ₁ (mm)	D ₂ (mm)	H (mm)	L (mm)	(g)	(pcs.)	
18106	32	54	16	68	640	2	*1

*1 C-Ring=C81, Pin/O-Ring=A81/B81 → P256-257

16106-SC

Replacement Screw : M6x10, 3mm

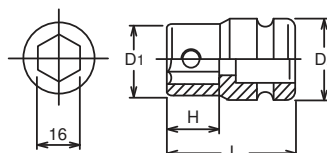

Impact Sockets Impact Steckschlüssel Douilles Impact

1"

Z-SERIES
HAND
TITANIUM
SCREWDRIVERS
ACCESSORIES
IMPACT
SLEEVE-DRIVE
PROTECTOR
INDUSTRIAL
AUTOMOTIVE
MOTORCYCLE
CONSTRUCTION
SPARE PART

107-16

Bits for Inhex Screws
Klingen für Innensechskant-Schrauben
Emboutis pour vis 6-pans males creux



107-16 (mm)	L (mm)	(g)	(pcs.)
10	40	46	10
12	40	52	10
13	40	56	10
14	40	60	10
16	40	69	10
17	40	73	10
18	40	78	10
19	40	80	10
22	40	97	10

107-16 (inch)	L (mm)	(g)	(pcs.)
3/8	40	45	10
7/16	40	53	10
1/2	40	56	10
9/16	40	60	10
5/8	40	69	10
3/4	40	80	10

107-16(L100) (mm)	L (mm)	R (mm)	(g)	(pcs.)
10	100	13	118	10
12	100	15	141	10
14	100	-	163	10
17	100	-	185	10
19	100	-	228	10
22	100	-	293	10

The items with have larger output size than 16mm input hex drive. Due to this design the Maximum output torque rating is less than standards.

107-16 (T)

TORX® Bits
TORX® Klingen
Emboutis, TORX®

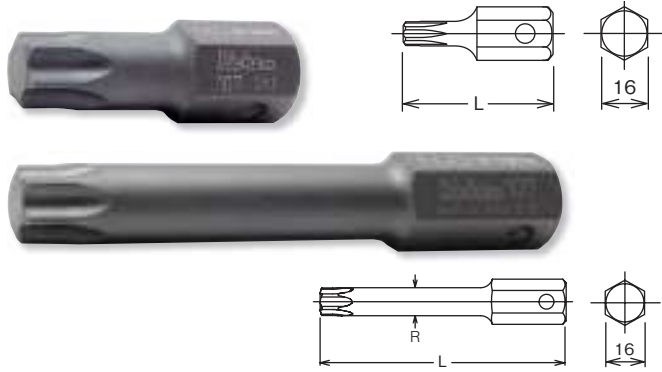

107-16 (T)	L (mm)	(g)	(pcs.)
T45	50	45	10
T50	50	50	10
T55	50	57	10
T60	50	64	10
T70	50	73	10

107-16(L100) (T)	L (mm)	R (mm)	(g)	(pcs.)
T45	100	8	95	10
T50	100	9	100	10
T55	100	11.4	104	10
T60	100	13.4	123	10
T70	100	15.7	148	10

107-16 (IP)

TORXPLUS® Bits
TORXPLUS® Klingen
Emboutis TORXPLUS®



107-16 (IP)	L (mm)	(g)	(pcs.)
55IP	50	57	10
60IP	50	64	10
70IP	50	73	10

107-16 (XZN)

Bits XZN
Klingen XZN
Emboutis de vissage, XZN

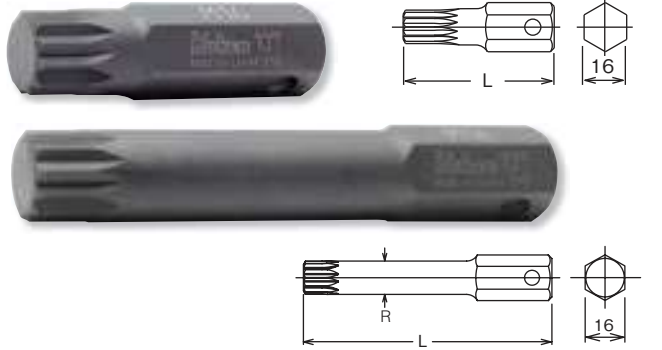

107-16 (XZN)	L (mm)	(g)	(pcs.)
M14	60	83	10
M16	60	93	10
M18	60	103	10

107-16(L100) (XZN)	L (mm)	R (mm)	(g)	(pcs.)
M14	100	13.4	126	10
M16	100	15.8	153	10
M18	100	17.1	173	10

18107-22 (mm)	D (mm)	H (mm)	L (mm)	(g)	(pcs.)	⚠
19	54	28	98	910	2	*1
22	54	28	98	932	2	*1
24	54	28	98	946	2	*1 ⚠
27	54	28	98	986	2	*1 ⚠
30	54	28	98	1008	2	*1 ⚠
32	54	28	103	1029	2	*1 ⚠

*1 C-Ring=C81, Pin/O-Ring=A81/B81 → P256-257



18107	D ₁ (mm)	D ₂ (mm)	H (mm)	L (mm)	(g)	(pcs.)	⚠
18107	44	54	22	70	770	2	*1

*1 C-Ring=C81, Pin/O-Ring=A81/B81 → P256-257

16107-SC

Replacement Screw : M8x14, ●4mm



18107-22 ⚠ Bit Holder complete with Bit, Inhex
Klingenhalter komplett mit Klinge, Innensechskant
Porte embouts avec bit 6-pans creux

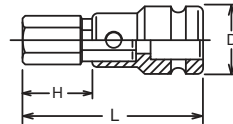

18107 ○ Bit Holder
Klingenhalter
Porte embouts

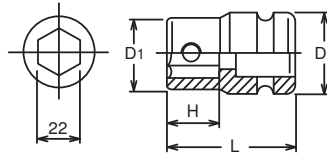

107-22 ⚠ Bits for Inhex Screws
Klingen für Innensechskant-Schrauben
Embouts pour vis 6-pans males creux

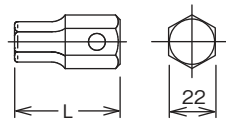

107-22 (T) ⚠ TORX® Bits
TORX® Klingen
Embouts, TORX®

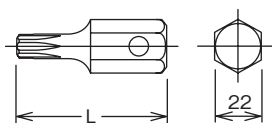

107-22 (mm)	L (mm)	(g)	(pcs.)
17	50	120	10
19	50	140	10
22	50	162	10
24	50	176	10
27	50	200	10
30	50	227	10
32	55	243	10

107-22 (inch)	L (mm)	(g)	(pcs.)
5/8	50	120	10
3/4	50	140	10
7/8	50	162	10
1	50	190	10
1. 1/4	55	243	10

107-22(L140) (mm)	L (mm)	(g)	(pcs.)
17	140	431	5
19	140	441	5
22	140	460	5
24	140	513	5

107-22 (T)	L (mm)	(g)	(pcs.)
T 70	60	129	10
T 80	60	141	10
T 90	60	155	10
T100	60	170	10

107-22(L140) (T)	L (mm)	(g)	(pcs.)
T 70	140	395	5
T 80	140	407	5
T 90	140	420	5
T100	140	434	5

⚠ The items with ⚠ have larger output size than 22mm input hex drive.
Due to this design the Maximum output torque rating is less than standards.

TORX is a registered trademark of CAMCAR Innovations.
TORX ist ein registriertes Markenzeichen der Firma CAMCAR Innovations.
TORX est une marque déposée de CAMCAR Innovations.

Impact Sockets Impact Steckschlüssel Douilles Impact

1"

Z-SERIES
HAND
TITANIUM
SCREWDRIVERS
ACCESSORIES
IMPACT
SLEEVE-DRIVE
PROTECTOR
INDUSTRIAL
AUTOMOTIVE
MOTORCYCLE
CONSTRUCTION
SPARE PART

18108 Bit Holder Klingenhalter Porte embouts

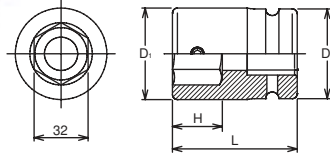

	D ₁ (mm)	D ₂ (mm)	H (mm)	L (mm)	(g)	(pcs.)	
18108	55	54	30	75	930	2	*1

*1 C-Ring=C81, Pin/O-Ring=A81/B81 → P256-257

18108-SC

 Replacement Screw : M8×12, ●4mm

107-32 Bit for Inhex Screws Klingen für Innensechskant-Schrauben Embouts pour vis 6-pans mâle creux

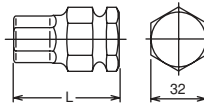

107.32 (mm)	L (mm)	(g)	(pcs.)
19	60	300	10
22	60	320	10
24	60	330	10
27	60	360	10
30	60	390	10
32	60	410	10
36	60	460	10



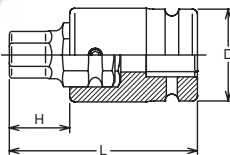

18108-32 Bit Holder complete with Bit, Inhex Klingenhalter komplett mit Klinge, Innensechskant Porte embouts avec bit 6-pans creux





18108.32 (mm)	D (mm)	H (mm)	L (mm)	(g)	(pcs.)	
19	54	30	105	1230	2	*1
22	54	30	105	1250	2	*1
24	54	30	105	1260	2	*1
27	54	30	105	1290	2	*1
30	54	30	105	1320	2	*1
32	54	30	105	1340	2	*1
36	54	30	105	1390	2	*1

*1 C-Ring=C81, Pin/O-Ring=A81/B81 → P256-257

 The items with  have larger output size than 32mm input hex drive.
Due to this design the Maximum output torque rating is less than DIN/ISO standards.

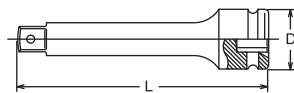
18760 Extension Bars Verlängerungen Rallonges



	D (mm)	L (mm)	(g)	(pcs.)	
18760-175	54	175	1400	1	*1
18760-200	54	200	1580	1	*1
18760-250	54	250	1885	1	*1
18760-330	54	330	2380	1	*1

*1 C-Ring=C81, Pin/O-Ring=A81/B81 → P256-257

	L (mm)	(g)	(pcs.)	
18888AL	95	980	2	*1

*1 C-Ring=C81, Pin/O-Ring=A81/B81 → P256-257

Lock & Quick Release

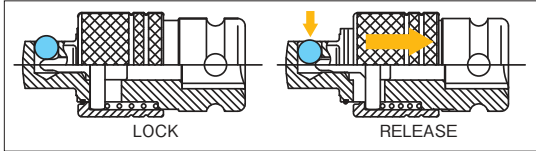

⚠ You may not hold the sliding part while moving to avoid heating up by friction and reduction by wear.

	L (mm)	(g)	(pce.)	
18770	127	1350	1	*1
18771	115	1210	1	*1

*1 C-Ring=C81, Pin/O-Ring=A81/B81 → P256-257

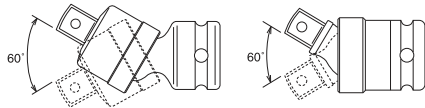

Our ball joints are spring-loaded and can therefore be adjusted to an angle of max. 30°.

Unsere Kugelgelenke sind federbelastet dadurch sind sie auf einen Winkel von max 30° einstellbar.

Nos joints à rotule sont à ressort et peuvent donc être réglés jusqu'à un angle de 30° maximum.

	(sq.)	(sq.)	L (mm)	(g)	(pce.)	
18866A	1"	3/4"	66.5	580	1	*1
18866A-200	1"	3/4"	200	1100	1	*1

*1 C-Ring=C81, Pin/O-Ring=A81/B81 → P256-257

⚠ Adapting down from bigger square drive to smaller square drive may lead to excessive torque load and possibly cause breakage. Always stay within safe torque of the smaller square drive.

Die mit **⚠** gekennzeichneten Artikel können bei Überbelastung zu Bruch gehen. Aus Gründen Ihrer eigenen Sicherheit sollten die betreffenden Werkzeuge nie ruckartig, sondern nach und nach belastet werden, um Bruch und damit verbundene mögliche Verletzungen zu vermeiden.

Il est possible d'appliquer aux articles marqués **⚠** des couples de serrage susceptibles d'occasionner leur rupture. Pour votre propre sécurité, veuillez toujours appliquer la charge d'une manière uniforme et progressive. Ceci pour éviter ruptures et accidents.

	(sq.)	(sq.)	L (mm)	(g)	(pce.)	
18877A	1"	1.1/2"	80	935	1	*1

*1 C-Ring=C81, Pin/O-Ring=A81/B81 → P256-257



LOCKING
ADAPTOR

18888AL

Adaptor (Quick Release)
Verbindungsstück (Quick Release) **⚠**
Adaptateur (Quick Release)

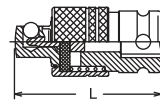

18770

Universal Joint
Gelenk-Einsatz
Joint articulé

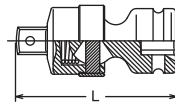

18771

Universal Joint
Gelenk-Einsatz
Joint articulé

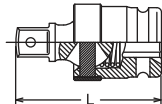

18866A

Adaptors
Verbindungsstücke
Réducteurs

No Warranty
Keine Garantie
Sans Garantie **⚠**

18866A-200 **⚠**

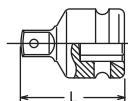

18877A

Adaptor
Verbindungsstück
Augmentateur

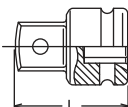

17400M / 17400A

6-point Sockets
6-kant Steckschlüssel
Douilles 6-pans

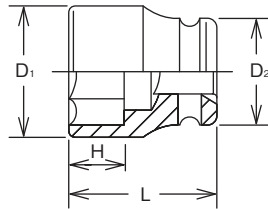

17400M (mm)	D ₁ (mm)	D ₂ (mm)	H (mm)	L (mm)	(g)	(pce.)	⊕
36	62	86	20	77	2126	1	*1
41	68	86	22	80	2346	1	*1
42	70	86	22	80	2330	1	*1
46	74	86	26	84	2360	1	*1
50	79	86	27	84	2400	1	*1
52	82	86	38	84	2340	1	*1
54	84	86	38	84	2340	1	*1
55	85	86	44	90	2450	1	*1
57	87	86	43	90	2460	1	*1
58	88	86	44	90	2510	1	*1
60	91	86	43	90	2640	1	*1
65	97	86	48	95	3050	1	*1
70	103	86	52	100	3350	1	*1
75	108	86	56	105	3700	1	*1
80	115	86	60	110	4240	1	*1
85	122	86	60	110	4550	1	*1
90	128	86	60	112	4840	1	*1
95	135	127	52	112	7660	1	*2
100	140	127	53	115	7700	1	*2
105	146	127	57	120	8000	1	*2
110	153	127	60	124	9200	1	*2
115	160	127	62	128	10700	1	*2
120	166	127	64	132	11200	1	*2
125	173	127	67	136	13000	1	*2
130	180	127	69	140	14200	1	*2
135	186	127	73	145	14940	1	*2
140	190	127	76	150	15600	1	*2
150	200	127	83	160	16500	1	*2

17400A (inch)	D ₁ (mm)	D ₂ (mm)	H (mm)	L (mm)	(g)	(pce.)	⊕
1. 5/8	68	86	22	80	2346	1	*1
1.11/16	71	86	22	80	2300	1	*1
1. 3/4	73	86	22	80	2290	1	*1
1.13/16	74	86	26	84	2360	1	*1
1. 7/8	77	86	26	84	2440	1	*1
1.15/16	79	86	27	84	2400	1	*1
2	80	86	27	84	2420	1	*1
2. 1/16	82	86	38	84	2340	1	*1
2. 1/8	84	86	38	84	2340	1	*1
2. 3/16	85	86	44	90	2450	1	*1
2. 1/4	87	86	43	90	2460	1	*1
2. 5/16	88	86	44	90	2510	1	*1
2. 3/8	91	86	43	90	2640	1	*1
2. 7/16	93	86	47	95	2860	1	*1
2. 1/2	96	86	47	95	3000	1	*1
2. 9/16	97	86	48	95	3050	1	*1
2. 5/8	100	86	51	100	3300	1	*1
2.11/16	101	86	51	100	3300	1	*1
2. 3/4	103	86	52	100	3350	1	*1
2.13/16	105	86	55	105	3670	1	*1
2. 7/8	106	86	55	105	3610	1	*1
2.15/16	108	86	56	105	3700	1	*1
3	108	86	55	105	3680	1	*1
3. 1/8	115	86	60	110	4240	1	*1
3. 1/4	118	86	59	110	4370	1	*1
3. 3/8	123	86	60	110	4570	1	*1
3. 1/2	128	86	60	112	4840	1	*1
3. 5/8	132	86	52	112	5500	1	*1
3. 3/4	135	127	52	112	7660	1	*2
3. 7/8	140	127	53	115	7700	1	*2
4	146	127	57	120	8000	1	*2
4. 1/8	146	127	57	120	8000	1	*2
4. 1/4	153	127	60	124	9200	1	*2
4. 1/2	160	127	62	128	10700	1	*2
4. 5/8	166	127	64	132	11200	1	*2
4. 3/4	168	127	64	132	11200	1	*2
4. 7/8	173	127	67	136	13000	1	*2
5	180	127	69	140	14200	1	*2
5. 1/4	186	127	73	145	14940	1	*2
6	205	127	88	165	16500	1	*2
6. 1/2	205	127	94	175	17500	1	*2

*1 C-Ring=C71, Pin/O-Ring=A71/B71

*2 Pin/O-Ring=A72/B72



1-1/2"

Impact Sockets
Impact Steckschlüssel
Douilles Impact

17405M (mm)	D ₁ (mm)	D ₂ (mm)	H (mm)	L (mm)	(g)	(pce.)	
46	74	86	26	84	2360	1	*1
50	79	86	27	84	2400	1	*1
55	85	86	44	90	2450	1	*1
60	91	86	43	90	2640	1	*1
65	97	86	48	95	3050	1	*1
70	103	86	52	100	3350	1	*1
75	108	86	56	105	3700	1	*1
80	115	86	60	110	4240	1	*1
85	122	86	60	110	4550	1	*1
90	128	86	60	112	4840	1	*1
95	135	127	52	112	7660	1	*2
100	140	127	53	115	7700	1	*2

17405A (inch)	D ₁ (mm)	D ₂ (mm)	H (mm)	L (mm)	(g)	(pce.)	
1.11/16	71	86	22	80	2300	1	*1
1. 3/4	73	86	22	80	2290	1	*1
1. 7/8	77	86	26	84	2440	1	*1
1.15/16	79	86	27	84	2400	1	*1
2	80	86	27	84	2420	1	*1
2. 1/16	82	86	38	84	2340	1	*1
2. 1/8	84	86	38	84	2340	1	*1
2. 3/16	85	86	44	90	2450	1	*1
2. 1/4	87	86	43	90	2460	1	*1
2. 3/8	91	86	43	90	2640	1	*1
2. 7/16	93	86	47	95	2860	1	*1
2. 1/2	96	86	47	95	3000	1	*1
2. 9/16	97	86	48	95	3050	1	*1
2. 5/8	100	86	51	100	3300	1	*1
2.13/16	105	86	55	105	3400	1	*1
2.15/16	108	86	56	105	3700	1	*1

*1 C-Ring=C71, Pin/O-Ring=A71/B71
*2 Pin/O-Ring=A72/B72

→ P256-257

17405M / 17405A

12-point Sockets
12-kant Steckschlüssel
Douilles 12-pans

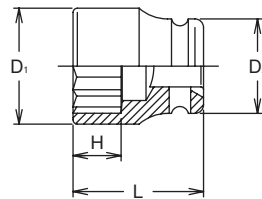

17300M / 17300A

6-point Deep Sockets
6-kant-Steckschlüssel,lang
Douilles longues 6-pans

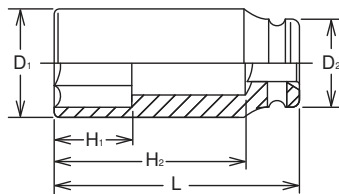

17300M (mm)	D ₁ (mm)	D ₂ (mm)	H ₁ (mm)	H ₂ (mm)	L (mm)	(g)	(pce.)	
36	63	86	26	70.5	115	2800	1	*1
41	68	86	27	70.5	115	3080	1	*1
42	70	86	27	70.5	115	3140	1	*1
46	74	86	28	80.5	125	3440	1	*1
50	79	86	30	90.5	135	3840	1	*1
54	84	86	30	90.5	135	4160	1	*1
55	85	86	33	90.5	135	4130	1	*1
60	91	86	35	90.5	135	4370	1	*1
65	97	86	38	99.5	145	5260	1	*1
70	103	86	40	98.5	145	5780	1	*1
75	108	86	42	107.5	155	6580	1	*1
80	115	86	46	115.5	165	7740	1	*1
85	122	86	49	114.5	165	7420	1	*1
90	128	86	52	122.5	175	9630	1	*1
95	135	127	55	121.5	175	10450	1	*2
100	140	127	58	130.5	185	9741	1	*2
105	146	127	62	138.5	195	10850	1	*2
110	153	127	65	137.5	195	11500	1	*2
115	160	127	68	135.5	195	12160	1	*2
120	166	127	72	144.5	205	13680	1	*2
125	173	127	74	142.5	205	14450	1	*2
130	180	127	76	142.5	205	15190	1	*2

*1 C-Ring=C71, Pin/O-Ring=A71/B71
*2 Pin/O-Ring=A72/B72

→ P256-257

17300A (inch)	D ₁ (mm)	D ₂ (mm)	H ₁ (mm)	H ₂ (mm)	L (mm)	(g)	(pce.)	
1. 5/8	68	86	27	70.5	115	3080	1	*1
1.11/16	71	86	27	70.5	115	3180	1	*1
1. 3/4	73	86	27	70.5	115	3210	1	*1
1.13/16	74	86	28	80.5	125	3440	1	*1
1. 7/8	77	86	28	80.5	125	3550	1	*1
1.15/16	79	86	28	80.5	125	3590	1	*1
2	80	86	30	90.5	135	3916	1	*1
2. 1/16	82	86	30	90.5	135	4030	1	*1
2. 1/8	84	86	30	90.5	135	4160	1	*1
2. 3/16	85	86	33	90.5	135	4200	1	*1
2. 1/4	87	86	33	90.5	135	4160	1	*1
2. 3/8	91	86	35	90.5	135	4370	1	*1
2. 7/16	93	86	35	90.5	135	4490	1	*1
2. 1/2	96	86	35	90.5	135	4630	1	*1
2. 9/16	97	86	38	99.5	145	5260	1	*1
2. 5/8	100	86	38	99.5	145	5320	1	*1
2.11/16	101	86	38	99.5	145	5670	1	*1
2. 3/4	103	86	40	98.5	145	5780	1	*1
2.13/16	105	86	40	98.5	145	6000	1	*1
2. 7/8	106	86	40	98.5	145	6080	1	*1
2.15/16	108	86	42	107.5	155	6580	1	*1
3	108	86	42	107.5	155	6850	1	*1
3. 1/8	115	86	46	115.5	165	7740	1	*1
3. 3/4	135	127	55	121.5	175	12200	1	*2
3. 7/8	140	127	56	120.5	175	11080	1	*2

*1 C-Ring=C71, Pin/O-Ring=A71/B71
*2 Pin/O-Ring=A72/B72

→ P256-257

Z-SERIES
HAND
TITANIUM
ACCESSORIES
SCREWDRIVERS
IMPACT
SLEEVE-DRIVE
PROTECTOR
INDUSTRIAL
AUTOMOTIVE
MOTORCYCLE
CONSTRUCTION
SPARE PART

Impact Sockets Impact Steckschlüssel Douilles Impact

1-1/2"

Z-SERIES
HAND
TITANIUM
SCREWDRIVERS ACCESSORIES
IMPACT
SLEEVE-DRIVE
PROTECTOR
INDUSTRIAL
AUTOMOTIVE
CONSTRUCTION MOTORCYCLE
SPARE PART

17108 Bit Holder Klingenhalter Porte-embouts

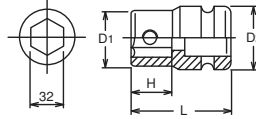

	D ₁ (mm)	D ₂ (mm)	H (mm)	L (mm)	 (g)	 (pce.)	
17108	60	86	30	85	2200	1	*1



*1 C-Ring=C71, Pin/O-Ring=A71/B71 → P256-257

16107-SC

 Replacement Screw : M8×14, ●4mm
Ersatzschraube : M8×14, ●4mm
Vis de remplacement : M8×14, ●4mm

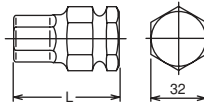



107-32 Bit for Inhex Screws Klingen für Innensechskant-Schrauben Embouts pour vis 6-pans mâle creux



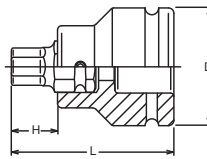

107-32 (mm)	L (mm)	 (g)	 (pcs.)
19	60	300	10
22	60	320	10
24	60	330	10
27	60	360	10
30	60	390	10
32	60	410	10
36	60	460	10 

17108-32 Bit Holder complete with Bit Klingenhalter, komplett mit Klinge Porte embouts avec bit



17108-32 (mm)	D (mm)	H (mm)	L (mm)	 (g)	 (pce.)	
19	86	30	115	2500	1	*1
22	86	30	115	2520	1	*1
24	86	30	115	2530	1	*1
27	86	30	115	2560	1	*1
30	86	30	115	2590	1	*1
32	86	30	115	2610	1	*1
36	86	30	115	2660	1	*1 

*1 C-Ring=C71, Pin/O-Ring=A71/B71 → P256-257

 The items with  have larger output size than 32mm input hex drive.
Due to this design the Maximum output torque rating is less than DIN/ISO standards.



1-1/2"

Impact Sockets
Impact Steckschlüssel
Douilles Impact

	D (mm)	L (mm)	(g)	(pce.)	⚡
17760-175	86	175	3300	1	*1
17760-250	86	250	4500	1	*1
17760-330	86	330	5200	1	*1

*1 C-Ring=C71, Pin/O-Ring=A71/B71 → P256-257

17760 Extension Bars
Verlängerungen
Rallonges

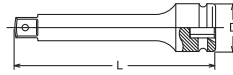

	L (mm)	(g)	(pce.)	⚡
17770	200	4700	1	*1

*1 C-Ring=C71, Pin/O-Ring=A71/B71 → P256-257

17770 Universal Joint
Gelenk-Einsatz
Joint articulé

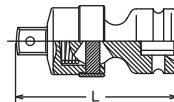

	(sq.)	(sq.)	L (mm)	(g)	(pce.)	⚡
17788A	1.1/2"	1"	98	2600	1	*1

*1 C-Ring=C71, Pin/O-Ring=A71/B71 → P256-257

⚠ Adapting down from bigger square drive to smaller square drive may lead to excessive torque load and possibly cause breakage. Always stay within safe torque of the smaller square drive.

Die mit **⚠** gekennzeichneten Artikel können bei Überbelastung zu Bruch gehen. Aus Gründen Ihrer eigenen Sicherheit sollten die betreffenden Werkzeuge nie ruckartig, sondern nach und nach belastet werden, um Bruch und damit verbundene mögliche Verletzungen zu vermeiden.

Il est possible d'appliquer aux articles marqués **⚠** des couples de serrage susceptibles d'occasionner leur rupture. Pour votre propre sécurité, veuillez toujours appliquer la charge d'une manière uniforme et progressive. Ceci pour éviter ruptures et accidents.

17788A **⚠** Adaptor
Verbindungsstück
Réducteur
No Warranty
Keine Garantie
Sans Garantie

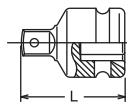

	(sq.)	(sq.)	L (mm)	(g)	(pce.)	⚡
17799A	1.1/2"	2.1/2"	115	3790	1	*1

*1 C-Ring=C71, Pin/O-Ring=A71/B71 → P256-257

17799A Adaptor
Verbindungsstück
Augmentateur

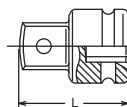

Z-SERIES
HAND
TITANIUM
ACCESSORIES
SCREWDRIVERS
IMPACT
SLEEVE-DRIVE
PROTECTOR
INDUSTRIAL
AUTOMOTIVE
MOTORCYCLE
CONSTRUCTION
SPARE PART

19400M / 19400A

6-point Sockets
6-kant Steckschlüssel
Douilles 6-pans

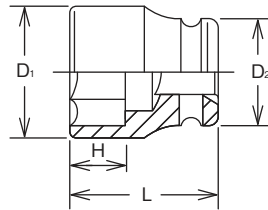

19400M (mm)	D ₁ (mm)	D ₂ (mm)	H (mm)	L (mm)	(g)	(pce.)	
50	88	127	39	115	6550	1	*1
55	94	127	42	115	6720	1	*1
60	100	127	45	125	7430	1	*1
65	105	127	48	125	7350	1	*1
70	110	127	51	125	7260	1	*1
75	118	127	54	125	7170	1	*1
80	124	127	57	125	6960	1	*1
85	127	127	61	132	7320	1	*1
90	135	127	64	132	7950	1	*1
95	140	127	71	140	8660	1	*1
100	146	127	71	142	9230	1	*1
105	155	127	74	146	11600	1	*1
110	160	127	76	155	11600	1	*1
115	167	127	78	158	12600	1	*1
120	175	175	79	160	18500	1	*2
125	180	175	82	165	19400	1	*2
130	185	175	85	169	20600	1	*2
135	190	175	89	175	21800	1	*2
140	200	175	93	180	24000	1	*2
145	205	175	95	183	25300	1	*2
150	210	175	97	192	27600	1	*2
160	225	175	102	200	31700	1	*2
165	230	175	105	204	33100	1	*2
170	235	175	106	207	34100	1	*2
175	240	175	109	211	35600	1	*2
180	250	175	110	214	40300	1	*2
185	255	175	113	218	40300	1	*2
190	265	175	113	220	46400	1	*2
200	275	175	116	225	46400	1	*2
210	285	175	123	235	50200	1	*2
215	290	175	126	240	51000	1	*2
225	305	175	133	250	55700	1	*2
235	315	175	140	260	59600	1	*2

19400A (inch)	D ₁ (mm)	D ₂ (mm)	H (mm)	L (mm)	(g)	(pce.)	
2. 1/8	92	127	41	115	6670	1	*1
2. 3/8	100	127	45	125	7430	1	*1
2. 7/16	102	127	46	125	7440	1	*1
2. 1/2	103	127	47	125	7280	1	*1
2. 9/16	105	127	48	125	7350	1	*1
2. 5/8	107	127	49	125	7260	1	*1
2.11/16	108	127	50	125	7260	1	*1
2. 3/4	110	127	51	125	7260	1	*1
2.13/16	113	127	52	125	7170	1	*1
2. 7/8	115	127	53	125	7170	1	*1
2.15/16	118	127	54	125	7260	1	*1
3	120	127	55	125	7250	1	*1
3. 1/8	124	127	57	125	6960	1	*1
3. 1/4	125	127	59	125	6970	1	*1
3. 3/8	127	127	61	132	7320	1	*1
3. 1/2	135	127	64	132	7950	1	*1
3. 5/8	138	127	64	132	8180	1	*1
3. 3/4	140	127	71	140	8660	1	*1
3. 7/8	143	127	70	140	8730	1	*1
4	146	127	71	142	9230	1	*1
4. 1/8	155	127	70	142	11600	1	*1
4. 1/4	160	127	76	155	11600	1	*1
4. 3/8	163	127	76	155	12600	1	*1
4. 1/2	167	127	78	158	12600	1	*1
4. 5/8	175	175	79	160	18500	1	*2
4. 7/8	180	175	82	165	19400	1	*2
5	183	175	81	165	20100	1	*2
5. 1/4	190	175	89	175	21800	1	*2
5. 3/8	198	175	94	180	24200	1	*2
5. 1/2	200	175	93	180	24000	1	*2
5. 5/8	203	175	94	182	25300	1	*2
5. 3/4	207	175	103	192	26600	1	*2
6	217	175	100	196	31700	1	*2
6. 1/8	218	175	99	196	31700	1	*2
6. 5/8	233	175	105	205	34100	1	*2
7	248	175	110	213	40300	1	*2

*1 Pin/O-Ring=A91/B91
*2 Pin/O-Ring=A92/B92



2-1/2" Impact Sockets Impact Steckschlüssel Douilles Impact

Z-SERIES
HAND
TITANIUM
ACCESSORIES
SCREWDRIVERS
IMPACT
SLEEVE-DRIVE
PROTECTOR
INDUSTRIAL
AUTOMOTIVE
MOTORCYCLE
CONSTRUCTION
SPARE PART

19300M (mm)	D ₁ (mm)	D ₂ (mm)	H ₁ (mm)	H ₂ (mm)	L (mm)	(g)	(pce.)	⚡
75	118	127	42	129	190	11600	1	*1
80	124	127	46	129	190	11800	1	*1
85	127	127	49	134	195	12000	1	*1
90	135	127	52	144	205	13800	1	*1
95	140	127	55	149	210	14100	1	*1
100	146	127	58	154	215	15700	1	*1
105	155	127	62	146.5	220	18000	1	*1
110	160	127	65	150.5	225	18900	1	*1
115	167	127	68	153.5	230	20700	1	*1
120	175	175	72	157.5	235	28000	1	*2
125	180	175	74	158.5	238	29100	1	*2
130	185	175	76	163.5	243	31000	1	*2
135	190	175	80	165.5	248	32100	1	*2
140	200	175	82	164.5	248	34700	1	*2
145	205	175	84	163.5	248	35900	1	*2
150	210	175	88	168.5	255	37200	1	*2
155	215	175	92	167.5	255	38200	1	*2
160	225	175	95	170.5	260	42000	1	*2
165	230	175	98	169.5	260	42700	1	*2
170	235	175	100	172.5	265	44400	1	*2
175	240	175	102	176.5	270	46100	1	*2

*1 Pin/O-Ring=A91/B91 → P257
*2 Pin/O-Ring=A92/B92

	D (mm)	L (mm)	(g)	(pce.)	⚡
19760-250	127	250	17800	1	*1
19760-500	127	500	27800	1	*1

*1 Pin/O-Ring=A91/B91 → P257

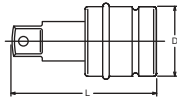

	L (mm)	(g)	(pce.)	⚡
19770	303	21360	1	*1

*1 Pin/O-Ring=A91/B91 → P257

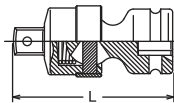

	(sq.)	(sq.)	L (mm)	(g)	(pce.)	⚡
19977A	2.1/2"	1.1/2"	145	7210	1	*1

*1 Pin/O-Ring=A91/B91 → P257

⚠ Adapting down from bigger square drive to smaller square drive may lead to excessive torque load and possibly cause breakage. Always stay within safe torque of the smaller square drive.

Die mit ⚠ gekennzeichneten Artikel können bei Überbelastung zu Bruch gehen. Aus Gründen Ihrer eigenen Sicherheit sollten die betreffenden Werkzeuge nie ruckartig, sondern nach und nach belastet werden, um Bruch und damit verbundene mögliche Verletzungen zu vermeiden.

Il est possible d'appliquer aux articles marqués ⚠ des couples de serrage susceptibles d'occasionner leur rupture. Pour votre propre sécurité, veuillez toujours appliquer la charge d'une manière uniforme et progressive. Ceci pour éviter ruptures et accidents.

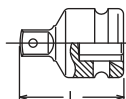

19300M 6-point Deep Sockets 6-kant-Steckschlüssel, lang Douilles longues 6-pans

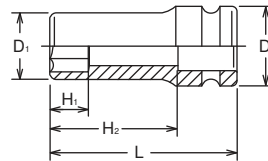

19760 Extension Bars Verlängerungen Rallonges



19770 Universal Joint Gelenk-Einsatz Joint articulé



19977A Adaptor Verbindungsstück Réducteur

No Warranty
Keine Garantie
Sans Garantie ⚠



Z-SERIES
HAND
TITANIUM
ACCESSORIES
IMPACT
SLEEVE-DRIVE
PROTECTOR
INDUSTRIAL
AUTOMOTIVE
MOTORCYCLE
CONSTRUCTION
SPARE PART

10400M / 10400A

6-point Sockets
6-kant Steckschlüssel
Douilles 6-pans

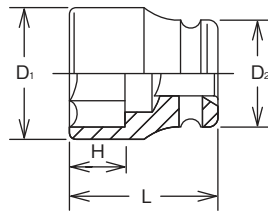

10400M (mm)	D ₁ (mm)	D ₂ (mm)	H (mm)	L (mm)	(g)	(pce.)	
105	165	175	86	176	19370	1	*1
110	170	175	88	179	20160	1	*1
115	175	175	90	183	21160	1	*1
120	180	175	91	185	21930	1	*1
125	188	175	94	190	23940	1	*1
130	193	175	97	194	25050	1	*1
135	200	175	101	199	26930	1	*1
140	205	175	105	205	28560	1	*1
145	210	200	106	207	29600	1	*2
150	215	200	109	212	31240	1	*2
160	228	200	114	220	35500	1	*2
165	235	200	117	224	37940	1	*2
170	240	200	118	227	39660	1	*2
175	245	200	121	231	41400	1	*2
180	255	200	122	234	45740	1	*2
185	265	200	125	238	50350	1	*2
190	275	200	125	239	54650	1	*2
200	285	200	128	245	59190	1	*2
210	295	200	135	255	64970	1	*2
215	300	200	138	260	68150	1	*2

10400A (inch)	D ₁ (mm)	D ₂ (mm)	H (mm)	L (mm)	(g)	(pce.)	
4.1/8	165	175	86	176	19370	1	*1
4.1/4	168	175	87	178	19770	1	*1
4.3/8	172	175	88	180	20660	1	*1
4.1/2	175	175	89	182	21160	1	*1
4.5/8	178	175	90	183	21550	1	*1
4.3/4	180	175	91	185	21930	1	*1
4.7/8	188	175	94	190	23940	1	*1
5	188	175	95	191	24500	1	*1
5.1/8	193	175	97	194	25050	1	*1
5.1/4	197	175	100	198	25990	1	*1
5.3/8	201	175	102	202	27750	1	*1
5.1/2	205	175	105	205	28560	1	*1
5.5/8	208	200	106	208	30110	1	*2
5.3/4	212	200	108	210	30610	1	*2
5.7/8	215	200	109	212	31240	1	*2
6	219	200	110	214	32460	1	*2
6.1/8	223	200	112	216	33670	1	*2
6.1/4	227	200	114	218	34590	1	*2
6.3/8	231	200	115	221	36720	1	*2
6.1/2	235	200	117	224	37940	1	*2
6.5/8	238	200	118	226	38800	1	*2
6.3/4	241	200	119	228	39870	1	*2
6.7/8	245	200	120	230	40640	1	*2
7	251	200	121	232	43570	1	*2
7.1/8	257	200	122	234	46450	1	*2
7.1/4	263	200	123	236	48400	1	*2
7.3/8	269	200	124	238	52500	1	*2
7.1/2	275	200	125	240	55350	1	*2
7.5/8	278	200	127	242	56050	1	*2
7.3/4	282	200	129	245	57620	1	*2
7.7/8	285	200	130	248	60870	1	*2
8	290	200	132	250	62550	1	*2
8.1/8	293	200	133	251	63760	1	*2
8.1/4	295	200	135	255	64970	1	*2
8.3/8	298	200	136	258	65580	1	*2
8.1/2	300	200	138	260	68150	1	*2
8.5/8	305	200	139	262	70760	1	*2
8.3/4	310	200	140	264	73830	1	*2
8.7/8	313	200	142	267	75780	1	*2

*1 Pin/O-Ring=A01/B01 → P257
*2 Pin/O-Ring=A02/B02

10099A

Adaptor
Verbindungsstück
Réducteur

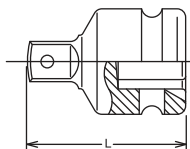

	(sq.)	(sq.)	L (mm)	(g)	(pce.)	
10099A	3.1/2"	2.1/2"	182	16870	1	*1

*1 Pin/O-Ring=A01/B01 → P257

⚠ Adapting down from bigger square drive to smaller square drive may lead to excessive torque load and possibly cause breakage. Always stay within safe torque of the smaller square drive.

Die mit **⚠** gekennzeichneten Artikel können bei Überbelastung zu Bruch gehen. Aus Gründen Ihrer eigenen Sicherheit sollten die betreffenden Werkzeuge nie ruckartig, sondern nach und nach belastet werden, um Bruch und damit verbundene mögliche Verletzungen zu vermeiden.

Il est possible d'appliquer aux articles marqués **⚠** des couples de serrage susceptibles d'occasionner leur rupture. Pour votre propre sécurité, veuillez toujours appliquer la charge d'une manière uniforme et progressive. Ceci pour éviter ruptures et accidents.

SLEEVE-DRIVE SOCKETS SLEEVE-DRIVE STECKSCHLÜSSEL DOUILLES, SLEEVE DRIVE

3/8"

1/2"

3/4"



Sleeve-Drive Sockets
 Sleeve-Drive Steckschlüssel
 Douilles, Sleeve Drive

Z-SERIES
 HAND
 TITANIUM
 SCREWDRIVERS ACCESSORIES
 IMPACT
 SLEEVE-DRIVE
 PROTECTOR
 INDUSTRIAL
 AUTOMOTIVE
 MOTORCYCLE
 CONSTRUCTION
 SPARE PART



The deepened drive end of the **Sleeve-Drive** tools prevents the sometimes "wobbly" connection between pulse tool - extension - socket. An O-ring inside **Sleeve-Drive** optimizes the perfect fit of extension bars and sockets on the anvil to the effect, that the exactness of the required torque given by the pulse tool is generally improved. Further, the **Sleeve-Drive** avoids the direct transmission of vibrations on the pulse tool and finally on the operator.

Der **Sleeve-Drive** Vierkant-Antrieb vermeidet durch die vertiefte Passung den "Wackelkontakt" zwischen Maschine - Verlängerung - Steckschlüssel. Ein im **Antriebsende der Sleeve-Drive-Steckschlüssel** eingesetzter Ring optimiert den festen Sitz der Verlängerungen und Steckschlüssel auf der Schrauberspindel und sorgt somit für die unmittelbare Weitergabe des vorgegebenen Drehmomentes ohne wesentliche Drehkraftverluste. Nicht zuletzt vermeidet der **Sleeve-Drive** Antrieb die Übertragung von Schwingungen auf Mensch und Maschine.

Ces nouveaux outils **Sleeve-Drive** se caractérisent par un entraînement carré allongé et un joint torique incorporé. Le guidage rigide ainsi obtenu maintient les outils **Sleeve-Drive** dans l'axe de la broche de la machine et garantit une connection optimale machine-rallonges-douilles. Le jeu latéral et les vibrations engendrés par les outils traditionnels sont de ce fait supprimés. Il en résulte une transmission plus précise du coupe de serrage et un plus grand confort de travail pour l'opérateur.

Sleeve Drive Sockets

Wrenches

O-Ring



SLEEVE DRIVE SOCKET

PULSE TOOL

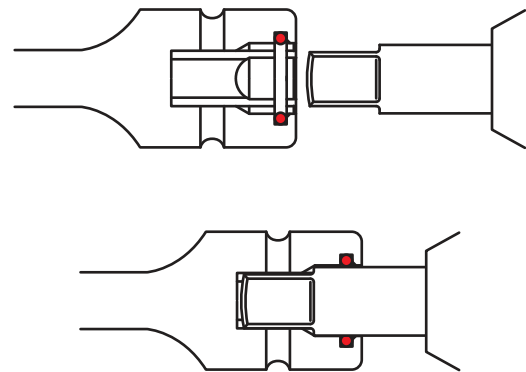

The "**Sleeve Drive**" Sockets and accessories are designed for use on Pulse Tools with anvils of certain lengths and diameters as shown hereunder.

Die serienmässigen "**Sleeve Drive**" Steckschlüssel können nur auf Impuls Schraubern mit Antriebswellen der nachstehenden Längen und Durchmesser gesteckt werden.

Les douilles "**Sleeve Drive**" ne peuvent être placées que sur des axes des boulonneuses à impulsions d'une longueur et d'un diamètre selon la spécification ci-dessous.

	Anvil Diameter (mm)	Minimum Anvil Length (mm)
3/8"sq.	12	10
1/2"sq.	16	10
3/4"sq.	25	11.8

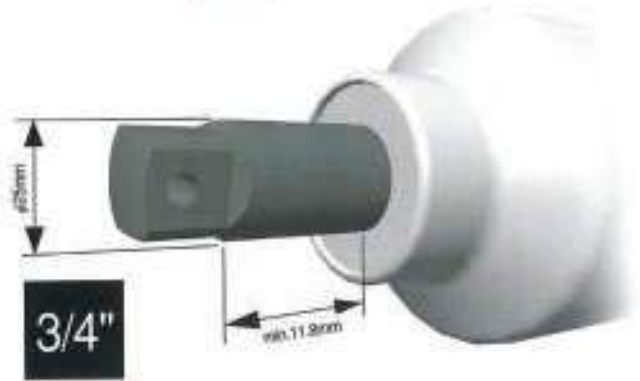

3/8"

Sleeve-Drive Sockets
Sleeve-Drive Steckschlüssel
Douilles, Sleeve Drive

NV13400 (mm)	D ₁ (mm)	D ₂ (mm)	H (mm)	L (mm)	(g)	(pcs.)	
8	13.3	19	6	43	53	10	*1
10	15.8	19	7	43	53	10	*1
11	17	19	8	43	54	10	*1
12	18.3	19	9	43	55	10	*1
13	19.5	22	10	43	80	10	*2
14	20.8	22	10	43	80	10	*2
15	22	22	11	43	81	10	*2
16	23.3	22	11	43	83	10	*2
17	24.5	22	11	43	85	10	*2
18	25.8	22	11	43	89	10	*2
19	27	22	11	43	98	10	*2
21	29.5	22	11	43	105	10	*2
22	30.8	22	11	43	112	10	*2

*1 C-Ring=C31, Pin/O-Ring=A31/B31
*2 C-Ring=C32, Pin/O-Ring=A32/B32

→ P256-257

NV13400

6-point Sockets
6-kant Steckschlüssel
Douilles 6-pans

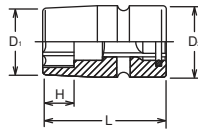

NV13145-100 (mm)	D ₁ (mm)	D ₂ (mm)	H (mm)	L (mm)	(g)	(pcs.)	
6	13	19	6	100	108	5	*1
8	13	19	8	100	110	5	*1
10	15.5	19	10	100	112	5	*1
12	18	19	12	100	120	5	*1
13	19	19	13	100	127	5	*1
14	21	19	14	100	131	5	*1
15	22	19	15	100	133	5	*1
16	24	19	15	100	144	5	*1
17	25	19	15	100	154	5	*1

NV13145-150 (mm)	D ₁ (mm)	D ₂ (mm)	H (mm)	L (mm)	(g)	(pcs.)	
6	13	19	6	150	160	5	*1
8	13	19	8	150	160	5	*1
10	15.5	19	10	150	165	5	*1
12	18	19	12	150	168	5	*1
13	19	19	13	150	170	5	*1
14	21	19	14	150	175	5	*1
15	22	19	15	150	177	5	*1
16	24	19	15	150	190	5	*1
17	25	19	15	150	203	5	*1

NV13145-200 (mm)	D ₁ (mm)	D ₂ (mm)	H (mm)	L (mm)	(g)	(pcs.)	
6	13	19	6	200	210	5	*1
8	13	19	8	200	210	5	*1
10	15.5	19	10	200	212	5	*1
12	18	19	12	200	214	5	*1
13	19	19	13	200	218	5	*1
14	21	19	14	200	220	5	*1
15	22	19	15	200	226	5	*1
16	24	19	15	200	235	5	*1
17	25	19	15	200	250	5	*1

*1 C-Ring=C31, Pin/O-Ring=A31/B31

→ P256-257

NV13145-100 / -150 / -200

Extended Sockets
Schaftsteckschlüssel
Douilles rallongées

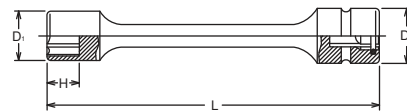

	D (mm)	L (mm)	(g)	(pcs.)	
NV13760-75P	19	75	95	10	*1
NV13760-125P	19	125	125	5	*1
NV13760-150P	19	150	150	5	*1
NV13760-250P	19	250	255	5	*1

*1 C-Ring=C31, Pin/O-Ring=A31/B31

→ P256-257

NV13760-P

Extension Bars
Verlängerungen
Rallonges

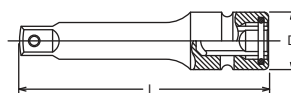

Z-SERIES
HAND
TITANIUM
ACCESSORIES
SCREWDRIVERS
IMPACT
SLEEVE-DRIVE
PROTECTOR
INDUSTRIAL
AUTOMOTIVE
MOTORCYCLE
CONSTRUCTION
SPARE PART

Z-SERIES
HAND
TITANIUM
SCREWDRIVERS ACCESSORIES
IMPACT
SLEEVE-DRIVE
PROTECTOR
INDUSTRIAL
AUTOMOTIVE
MOTORCYCLE
CONSTRUCTION
SPARE PART

183H-35 / -75 / -150

Hex Bits
Sechskant Bits
Embouts, 6 pans creux

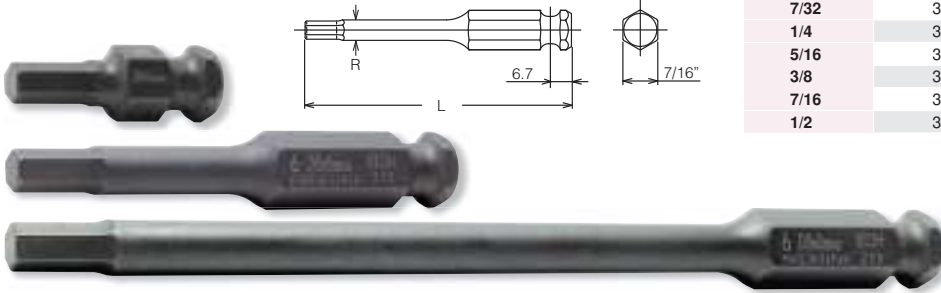

183H-35 (inch)	L (mm)	(g)	(pcs.)
3/16	35	15	10
7/32	35	16	10
1/4	35	18	10
5/16	35	20	10
3/8	35	26	10
7/16	35	28	10
1/2	35	38	10

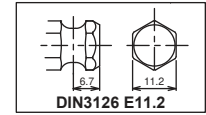

183H-35 (mm)	L (mm)	(g)	(pcs.)
3	35	15	10
4	35	15	10
5	35	15	10
6	35	18	10
7	35	19	10
8	35	20	10
9	35	23	10
10	35	26	10
11	35	28	10
12	35	30	10
14	35	35	10
16	35	47	10
17	35	50	10
18	35	53	10
19	35	56	10

183H-75 (mm)	L (mm)	R (mm)	(g)	(pcs.)
3	75	6	34	10
4	75	6	35	10
5	75	6.5	36	10
6	75	7.5	39	10
7	75	8.5	44	10
8	75	9.5	47	10
10	75	-	57	10
11	75	-	60	10
12	75	-	65	10
14	75	-	79	10

183H-150 (mm)	L (mm)	R (mm)	(g)	(pcs.)
4	150	6	51	10
5	150	6.5	55	10
6	150	7.5	65	10
8	150	9.5	87	10
10	150	-	118	10
12	150	-	136	10

183T-35 / -75 / -150 (T)

TORX® Bits
TORX® Bits
Embouts, TORX®

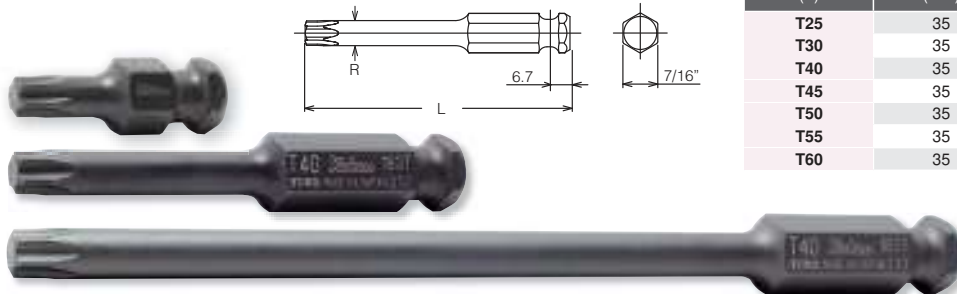

183T-35 (T)	L (mm)	(g)	(pcs.)
T25	35	18	10
T30	35	18	10
T40	35	20	10
T45	35	22	10
T50	35	26	10
T55	35	30	10
T60	35	38	10

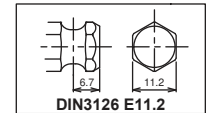

183T-150 (T)	L (mm)	R (mm)	(g)	(pcs.)
T30	150	6	50	10
T40	150	6.9	58	10
T45	150	8	70	10
T50	150	9	82	10
T55	150	11.4	113	10

183T-75 (T)	L (mm)	R (mm)	(g)	(pcs.)
T30	75	6	35	10
T40	75	6.9	37	10
T45	75	8	41	10
T50	75	9	45	10
T55	75	11.4	55	10
T60	75	13.5	67	10

183T-35 / -75 (IP)

TORXPLUS® Bits
TORXPLUS® Bits
Embouts TORXPLUS®

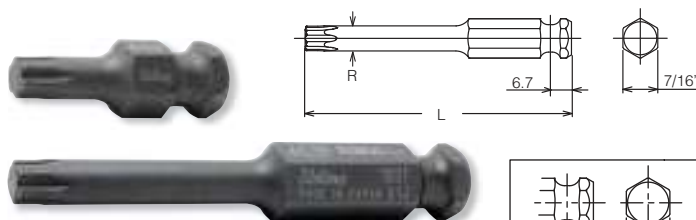

183T-35 (IP)	L (mm)	(g)	(pcs.)
30IP	35	18	10
40IP	35	20	10
45IP	35	22	10
50IP	35	26	10
55IP	35	30	10
60IP	35	38	10

183T-75 (IP)	L (mm)	R (mm)	(g)	(pcs.)
30IP	75	6	35	10
40IP	75	6.8	37	10
45IP	75	8	41	10
50IP	75	9	45	10
55IP	75	11.4	56	10
60IP	75	13.5	67	10

⚠ The items with ⚠ have larger output size than 7/16" in put hex drive.
Due to this design the Maximum output torque rating is less than standards.

3/8", 1/2"

Sleeve-Drive Sockets
Sleeve-Drive Steckschlüssel
Douilles, Sleeve Drive

183X-35 (XZN)	L (mm)	(g)	(pcs.)
M 4	35	18	10
M 5	35	18	10
M 6	35	20	10
M 8	35	22	10
M10	35	26	10
M12	35	30	10
M14	35	38	10

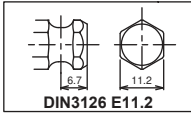

183X-35 / -75 / -150 (XZN)

XZN Bits
XZN Bits
Embouts, XZN

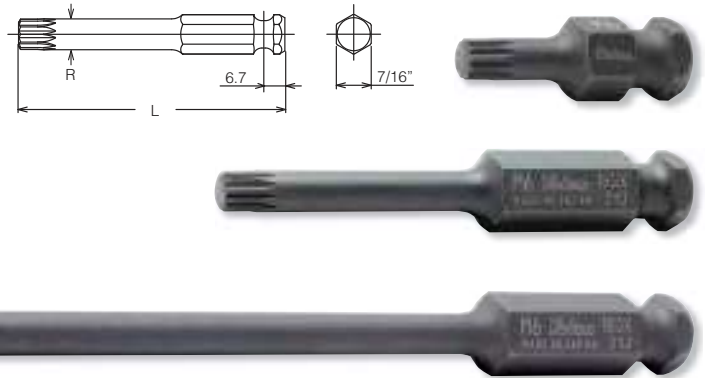

183X-75 (XZN)	L (mm)	R (mm)	(g)	(pcs.)
M 4	75	6	34	10
M 5	75	6	34	10
M 6	75	6.2	36	10
M 8	75	7.4	39	10
M10	75	9.8	54	10
M12	75	11.7	57	10
M14	75	13.5	67	10

183X-150 (XZN)	L (mm)	R (mm)	(g)	(pcs.)
M 5	150	6	50	10
M 6	150	6.2	53	10
M 8	150	7.4	64	10
M10	150	9.8	93	10
M12	150	11.7	121	10

NV13134	D ₁ (mm)	D ₂ (mm)	H (mm)	L (mm)	(g)	(pcs.)	
	24	22	15	45	100	5	*1

*1 C-Ring=C31, Pin/O-Ring=A31/B31 → P256-257

For DIN3126 E11.2 Bits
Für DIN3126 E11.2 Bits
Pour DIN3126 E11.2 Embouts

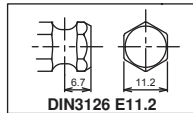

16134-SC

Replacement Screw : M8x6 ● 4mm

NV13134 Bit Holder Klingenhalter Porte-embouts

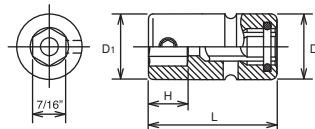

NV14134	D ₁ (mm)	D ₂ (mm)	H (mm)	L (mm)	(g)	(pcs.)	
	24	25	15	55	130	5	*1

*1 C-Ring=C41, Pin/O-Ring=A41/B41 → P256-257

For DIN3126 E11.2 Bits
Für DIN3126 E11.2 Bits
Pour DIN3126 E11.2 Embouts

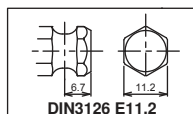

16134-SC

Replacement Screw : M8x6 ● 4mm

NV14134 Bit Holder Klingenhalter Porte-embouts

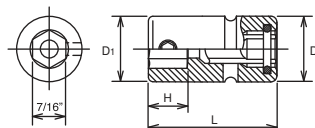

Z-SERIES
HAND
TITANIUM
ACCESSORIES
SCREWDRIVERS
IMPACT
SLEEVE-DRIVE
PROTECTOR
INDUSTRIAL
AUTOMOTIVE
MOTORCYCLE
CONSTRUCTION
SPARE PART

Sleeve-Drive Sockets

Sleeve-Drive Steckschlüssel

Douilles, Sleeve Drive

1/2"

Z-SERIES
HAND
TITANIUM
SCREWDRIVERS
ACCESSORIES
IMPACT
SLEEVE-DRIVE
PROTECTOR
INDUSTRIAL
AUTOMOTIVE
MOTORCYCLE
CONSTRUCTION
SPARE PART

NV14400

6-point Sockets
6-kant Steckschlüssel
Douilles 6-pans

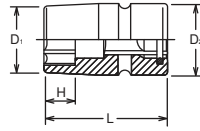

NV14400 (mm)	D ₁ (mm)	D ₂ (mm)	H (mm)	L (mm)	(g)	(pcs.)	
12	19.5	25	9	54	120	10	*1
13	20.7	25	10	54	120	10	*1
14	22	25	10	54	120	10	*1
15	23.2	30	11	54	188	10	*2
16	24.5	30	11	54	189	10	*2
17	25.7	30	12	54	190	10	*2
18	27	30	12	54	190	10	*2
19	28.2	30	12	54	190	10	*2
21	30.7	30	12	54	191	10	*2
22	32	30	12	54	192	10	*2
23	33.2	30	12	54	196	10	*2
24	34.5	30	12	54	200	10	*2

*1 C-Ring=C41, Pin/O-Ring=A41/B41 → P256-257
*2 C-Ring=C42, Pin/O-Ring=A42/B42

NV14145-100 / -150 / -200

Extended Sockets
Schafsteckschlüssel
Douilles rallongées



NV14145-100 (mm)	D ₁ (mm)	D ₂ (mm)	H (mm)	L (mm)	(g)	(pce.)	
10	15.5	25	10	100	161	1	*1
12	18	25	12	100	178	1	*1
13	19	25	13	100	175	1	*1
14	21	25	14	100	181	1	*1
15	22	25	15	100	185	1	*1
16	24	25	15	100	193	1	*1
17	25	25	15	100	201	1	*1
18	26	25	15	100	211	1	*1
19	28	25	15	100	221	1	*1

NV14145-150 (mm)	D ₁ (mm)	D ₂ (mm)	H (mm)	L (mm)	(g)	(pce.)	
10	15.5	25	10	150	200	1	*1
12	18	25	12	150	215	1	*1
13	19	25	13	150	220	1	*1
14	21	25	14	150	225	1	*1
15	22	25	15	150	230	1	*1
16	24	25	15	150	240	1	*1
17	25	25	15	150	250	1	*1
18	26	25	15	150	262	1	*1
19	28	25	15	150	275	1	*1

NV14145-200 (mm)	D ₁ (mm)	D ₂ (mm)	H (mm)	L (mm)	(g)	(pce.)	
10	15.5	25	10	200	236	1	*1
12	18	25	12	200	250	1	*1
13	19	25	13	200	260	1	*1
14	21	25	14	200	270	1	*1
15	22	25	15	200	275	1	*1
16	24	25	15	200	287	1	*1
17	25	25	15	200	300	1	*1
18	26	25	15	200	310	1	*1
19	28	25	15	200	320	1	*1

*1 C-Ring=C41, Pin/O-Ring=A41/B41 → P256-257

NV14760-P

Extension Bars
Verlängerungen
Rallonges

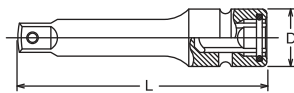

	D (mm)	L (mm)	(g)	(pcs.)	
NV14760-75P	25	75	149	10	*1
NV14760-125P	25	125	230	5	*1
NV14760-175P	25	175	308	5	*1
NV14760-250P	25	250	422	1	*1

*1 C-Ring=C41, Pin/O-Ring=A41/B41 → P256-257

NV14433A-P

Adaptors
Verbindungsstücke
Réducteurs

No Warranty
Keine Garantie
Sans Garantie

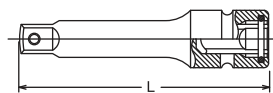

	(mm)	(mm)	L (mm)	(g)	(pcs.)	
NV14433A-75P	1/2"	3/8"	75	120	10	*1
NV14433A-100P	1/2"	3/8"	100	145	10	*1
NV14433A-150P	1/2"	3/8"	150	187	5	*1

*1 C-Ring=C41, Pin/O-Ring=A41/B41 → P256-257

⚠ Adapting down from bigger square drive to smaller square drive may lead to excessive torque load and possibly cause breakage. Always stay within safe torque of the smaller square drive.

Die mit ⚠ gekennzeichneten Artikel können bei Überbelastung zu Bruch gehen. Aus Gründen Ihrer eigenen Sicherheit sollten die betreffenden Werkzeuge nie ruckartig, sondern nach und nach belastet werden, um Bruch und damit verbundene mögliche Verletzungen zu vermeiden.

Il est possible d'appliquer aux articles marqués ⚠ des couples de serrage susceptibles d'occasionner leur rupture. Pour votre propre sécurité, veuillez toujours appliquer la charge d'une manière uniforme et progressive. Ceci pour éviter ruptures et accidents.

3/4"

Sleeve-Drive Sockets
Sleeve-Drive Steckschlüssel
Douilles, Sleeve Drive

NV16400 (mm)	D ₁ (mm)	D ₂ (mm)	H (mm)	L (mm)	(g)	(pcs.)	
17	30	44	12	65	448	5	*1
18	31.3	44	13	65	470	5	*1
19	32.5	44	13	65	455	5	*1
21	35	44	15	65	472	5	*1
22	36.3	44	16	65	471	5	*1
23	37.5	44	16	65	471	5	*1
24	38.8	44	16	65	467	5	*1
26	41.3	44	16	65	477	5	*1
27	42.5	44	16	65	473	5	*1
28	43.8	44	16	68	483	5	*1
29	45	44	18	68	464	5	*1
30	46.3	44	18	68	492	5	*1
32	48.8	44	19	70	514	5	*1
33	50	44	20	70	564	5	*1
34	51.3	44	20	70	588	5	*1
35	52.5	44	20	70	593	5	*1
36	53.8	44	20	70	598	5	*1
38	56.3	44	20	72	670	2	*1
41	60	44	22	72	687	2	*1
46	66.3	44	23	77	906	2	*1
50	69	44	23	77	1116	2	*1

*1 C-Ring=C61, Pin/O-Ring=A61/B61 → P256-257

NV16400



6-point Sockets
6-kant Steckschlüssel
Douilles 6-pans

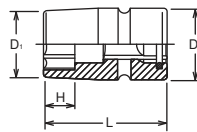

NV16760

Extension Bars
Verlängerungen
Rallonges



	D (mm)	L (mm)	(g)	(pcs.)	
NV16760-175	44	175	870	1	*1
NV16760-250	44	250	1160	1	*1
NV16760-330	44	330	1460	1	*1

*1 C-Ring=C61, Pin/O-Ring=A61/B61 → P256-257

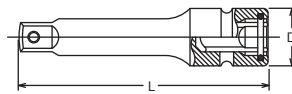

Z-SERIES
HAND
TITANIUM
ACCESSORIES
SCREWDRIVERS
IMPACT
SLEEVE-DRIVE
PROTECTOR
INDUSTRIAL
AUTOMOTIVE
MOTORCYCLE
CONSTRUCTION
SPARE PART

C-Ring Lock Clamps and Pullers
Sicherungsklemmen und Abzieher
Crochets de sécurité et extracteurs

Z-SERIES
HAND
TITANIUM
ACCESSORIES
IMPACT
SLEEVE-DRIVE
PROTECTOR
INDUSTRIAL
AUTOMOTIVE
MOTORCYCLE
CONSTRUCTION
SPARE PART



One Piece solid springs steel ring. Simply set by finger pushing and easily removed by puller. Much more convenient and safer than combination of pin and o-ring.

Aus starkem Federstahl, in einem Stück. Bequem, mit einem Fingerdruck einzusetzen und mit dem Auszieher zu lösen. Einfacher und sicherer als die Kombination Stift und Ring.

Acier à ressorts, en une pièce. Mise en place d'une simple pression du pouce, enlèvement au moyen de la griffe d'extraction. Beaucoup plus facile et sûr que la combinaison goupille/bague.

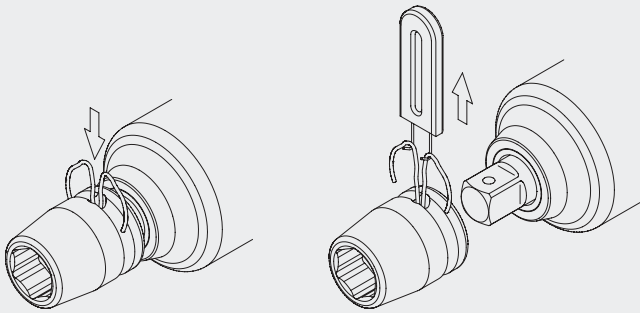

C-Ring

No.	□	Opening (mm)	pcs.
C31	3/8"	≤ 12	100
C32	3/8"	> 12	100
C41	1/2"	≤ 14	100
C42	1/2"	> 14	100
C61	3/4"	≤ 46	100
C81	1"	≤ 46	100
New C82	1"	47-70	50
C83	1"	> 70	50
C71	1-1/2"	≤ 90	50

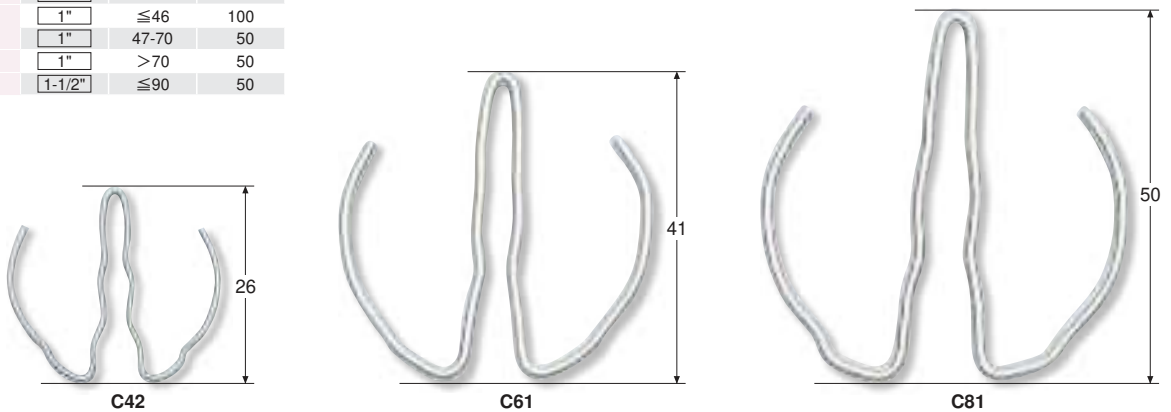
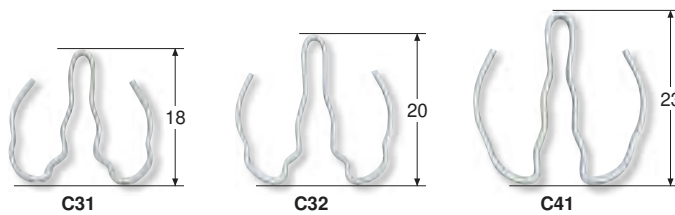

C-Ring Set

Set No.	□	C-Ring 10pcs.	Puller 1pce.
PKC31	3/8"	C31 + 149	
PKC32	3/8"	C32 + 149	
PKC41	1/2"	C41 + 149	
PKC42	1/2"	C42 + 149	
PKC61	3/4"	C61 + 152	
PKC81	1"	C81 + 152	

Puller

No.	□	□	pcs.
149	3/8"	1/2"	10
152	3/4"	1"	10



149



152

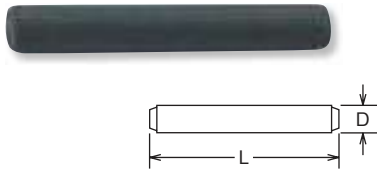

Pin

No.	□	Opening (mm)	D (mm)	L (mm)	pcs.
A21	1/4"		1.5	10.2	100
A31	3/8"	≤ 12	2.5	14.5	100
A32	3/8"	> 12	2.5	17.5	100
A41	1/2"	≤ 14	3	20	100
A42	1/2"	> 14	3	25	100
A51	5/8"		4	29	100
A61	3/4"	≤ 46	4	35	100
A62	3/4"	> 46	4	45	100
A81	1"	≤ 46	5	45	100
New A82	1"	47-70	5	57	50
A83	1"	> 70	5	75	50
A71	1-1/2"	≤ 90	6	75	50
A72	1-1/2"	> 90	6	110	1
A91	2-1/2"	≤ 115	8	110	1
A92	2-1/2"	> 115	8	155	1
A01	3-1/2"	≤ 140	13	155	1
A02	3-1/2"	> 140	13	180	1



O-Ring

No.	□	Opening (mm)	D ₁ (mm)	D ₂ (mm)	pcs.
B21	1/4"		2.5	9	100
B31	3/8"	≤ 12	3.5	13	100
B32	3/8"	> 12	3.5	16	100
B41	1/2"	≤ 14	4	19	100
B42	1/2"	> 14	4	24	100
B51	5/8"		5	28	100
B61	3/4"	≤ 46	5	36	100
B62	3/4"	> 46	5	45	100
B81	1"	≤ 46	7	45	100
B82	1"	47-70	7	57	50
New B83	1"	> 70	7	75	50
B71	1-1/2"	≤ 90	10	75	50
B72	1-1/2"	> 90	10	114	1
B91	2-1/2"	≤ 115	10.5	114	1
B92	2-1/2"	> 115	10.5	158	1
B01	3-1/2"	≤ 140	15	158	1
B02	3-1/2"	> 140	15	183	1



Z-SERIES
HAND
TITANIUM
ACCESSORIES
SCREWDRIVERS
IMPACT
SLEEVE-DRIVE
PROTECTOR
INDUSTRIAL
AUTOMOTIVE
MOTORCYCLE
CONSTRUCTION
SPARE PART

Pins & O Rings/C-Ring Lock Clamps
 Halteringe und Stifte/Sicherungsklemmen
 Goupilles et joncs/Crochets de sécurité

Z-SERIES
HAND
TITANIUM
ACCESSORIES
IMPACT
SLEEVE-DRIVE
PROTECTOR
INDUSTRIAL
AUTOMOTIVE
CONSTRUCTION
MOTORCYCLE
SPARE PART

IMPACT Standard Sockets size	Sq. Dr. C-Ring Pin/O-Ring	1/4"	3/8"		1/2"		3/4"		1"			1-1/2"	
			C31	C32	C41	C42	C61	C81	C81	C82	C83	C71	
		A21/B21	A31/B31	A32/B32	A41/B41	A42/B42	A61/B61	A62/B62	A81/B81	A82/B82	A83/B83	A71/B71	A72/B72
4		●											
4.5	3/16	●											
5		●											
5.5		●											
6	1/4	●	●			●							
7	9/32	●	●			●							
8	5/16	●	●			●							
9	11/32	●	●			●							
10	3/8	●	●			●							
11	7/16	●	●			●							
12		●	●			●							
13	1/2	●		●		●							
14	9/16	●		●		●							
15				●		●							
16	5/8			●		●							
17	11/16			●		●			●				
18				●		●			●				
19	3/4			●		●			●				
20				●		●			●				
21	13/16			●		●			●				
22	7/8			●		●			●				
23				●		●			●				
24	15/16			●		●			●				
25	1					●			●				
26						●			●				
27	1- 1/16					●			●				
28						●			●				
29	1- 1/8					●			●				
30	1- 3/16					●			●				
31						●			●				
32	1- 1/4					●			●				
33	1- 5/16					●			●				
34	1- 3/8					●			●				
36						●			●				
37	1- 7/16					●			●			●	
38	1- 1/2					●			●			●	
39						●			●			●	
40	1- 9/16					●			●			●	
41	1- 5/8					●			●			●	
42						●			●			●	
43	1- 11/16					●			●			●	
44						●			●			●	
45	1- 3/4					●			●			●	
46	1- 13/16					●			●			●	
47								●		●		●	
48	1- 7/8							●		●		●	
	1- 15/16							●		●		●	
50								●		●		●	
	2							●		●		●	
52	2- 1/16							●		●		●	
54	2- 1/8							●		●		●	
55	2- 3/16							●		●		●	
56								●		●		●	
	2- 1/4							●		●		●	
58	2- 5/16							●		●		●	
60	2- 3/8							●		●		●	
62	2- 7/16							●		●		●	
63								●		●		●	
	2- 1/2							●		●		●	
65	2- 9/16							●		●		●	
67	2- 5/8							●		●		●	
68	2- 11/16							●		●		●	
70	2- 3/4							●		●		●	
	2- 13/16							●		●		●	
	2- 7/8							●		●		●	
75	2- 15/16							●		●		●	
	3									●		●	
	3- 1/16									●		●	
80	3- 1/8									●		●	
	3- 1/4									●		●	
85										●		●	
	3- 3/8									●		●	
90	3- 1/2									●		●	
	3- 5/8									●		●	
95	3- 3/4									●		●	
100	3- 7/8									●		●	
105	4									●		●	
	4- 1/8											●	●
110	4- 1/4											●	●
115	4- 1/2											●	●
120	4- 5/8											●	●
	4- 3/4											●	●
125	4- 7/8											●	●
130	5											●	●
135	5- 1/4											●	●
140												●	●
150												●	●
	6											●	●
	6- 1/2											●	●

SOCKETS WITH TURNABLE PLASTIC PROTECTORS
STECKSCHLÜSSEL MIT DREHBAREN SCHUTZHÜLSEN AUS KUNSTSTOFF
DOUILLES A PROTECTIONS PLASTIFIEES





Safety

Turnable plastic protector increases operator's safety during assembly process.

Unsere drehbaren Kunststoff-Hülsen erhöhen die Arbeitssicherheit während des Montageprozesses.

Nos protections rotatives plastifiées augmentent la sécurité lors du montage.



Scratch proof

Protector helps to reduce the possibility giving damage on painted, polished and sensitive surfaces. Protector is free rotation designed.

Die Protektoren vermeiden Beschädigungen an lackierten-, polierten- bzw. empfindlichen Oberflächen. Unsere Protektoren sind frei drehbar.

Les protections évitent des endommagements sur des surfaces laquées, polies ou sensibles. Nos protections ont une libre rotation.

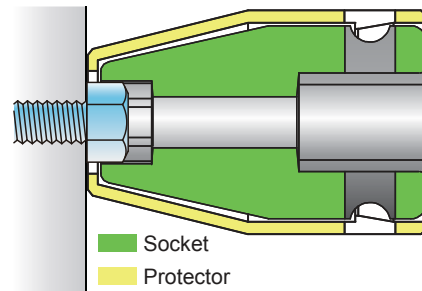

Z-SERIES
 HAND
 TITANIUM
 ACCESSORIES
 SCREWDRIVERS
 IMPACT
 SLEEVE-DRIVE
 PROTECTOR
 INDUSTRIAL
 AUTOMOTIVE
 MOTORCYCLE
 CONSTRUCTION
 SPARE PART

3/8" Protector Protektorehülsen Protections

Z-SERIES
HAND
TITANIUM
ACCESSORIES
SCREWDRIVERS
IMPACT
SLEEVE-DRIVE
PROTECTOR
INDUSTRIAL
AUTOMOTIVE
MOTORCYCLE
CONSTRUCTION
SPARE PART

13400M (mm)	D ₁ (mm)	D ₂ (mm)	H (mm)	L (mm)	(g)
8FR	15.7	22	6	33.3	40
10FR	18.2	22	7	33.3	40
12FR	20.8	22	9	33.3	43
13FR	21.8	25	10	33.3	56
14FR	23.6	25	10	33.3	56
16FR	26.1	25	11	33.3	57
17FR	27.3	25	12	33.3	60



13400M-FR

6-point Sockets
6-kant Steckschlüssel
Douilles 6-pans

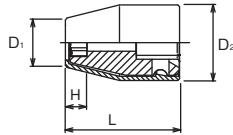

13300M (mm)	D ₁ (mm)	D ₂ (mm)	H ₁ (mm)	H ₂ (mm)	L (mm)	(g)
8FR	16.1	22	9	67.5	81.3	87
10FR	18.6	22	11	67.5	81.3	99
12FR	21.1	22	13	67.5	81.3	116
13FR	22.3	25	14	67.5	81.3	143
14FR	23.6	25	15	67.5	81.3	153
16FR	26	25	17	66.5	81.3	161
17FR	27.2	25	18	66.5	81.3	173

13300M-FR

6-point Sockets, deep
6-kant Steckschlüssel, lang
Douilles longues, 6-pans

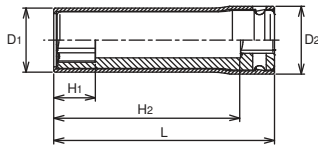

13300G (mm)	D ₁ (mm)	D ₂ (mm)	H ₁ (mm)	H ₂ (mm)	L (mm)	(g)
8FR	16.1	22	5	27.5	81.3	87
10FR	18.6	22	5.5	27	81.3	110
12FR	21.1	22	7	27	81.3	141
13FR	22.3	25	7.5	26	81.3	170
14FR	23.6	25	8	25	81.3	191
16FR	26	25	8.5	28	81.3	215
17FR	27.2	25	9	28	81.3	225

13300G-FR

Impact Socket with Sliding Magnet
Impact Steckschlüssel mit versenkbarem Magnet
Douilles Impact avec aimant, glissant pour écrous

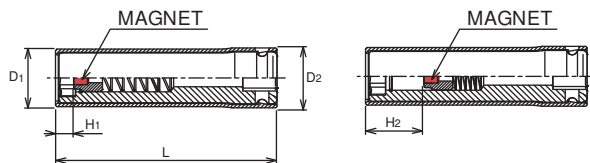

	D (mm)	L (mm)	(g)
13760-75P.FR	26.2	75	100
13760-125P.FR	26.2	125	145
13760-250P.FR	26.2	250	220

13760-P.FR

Extension Bars
Verlängerungen
Rallonges

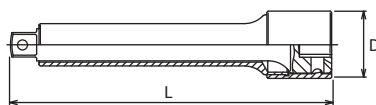

The protector could be broken with any impacts. Please handle with care.

Protector
 Protektorehülsen
 Protections

1/2"



Z-SERIES
 HAND
 TITANIUM
 ACCESSORIES
 SCREWDRIVERS
 IMPACT
 SLEEVE-DRIVE
 PROTECTOR
 INDUSTRIAL
 AUTOMOTIVE
 MOTORCYCLE
 CONSTRUCTION
 SPARE PART

14400M-FR  6-point Sockets
 6-kant Steckschlüssel
 Douilles 6-pans 

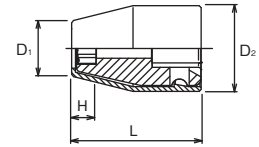

14400M (mm)	D ₁ (mm)	D ₂ (mm)	H (mm)	L (mm)	 (g)
10FR	19.5	28	7	39.3	90
12FR	22	28	9	39.3	90
13FR	23.2	28	10	39.3	90
14FR	24.8	28	11	39.3	90
New 15FR	26.6	33	11	39.3	135
16FR	27	33	10	39.3	135
17FR	28.2	33	12	39.3	135
New 18FR	30.2	33	13	39.3	135
19FR	31	33	13	39.3	130





14300M-FR  6-point Sockets, deep
 6-kant Steckschlüssel, lang 
 Douilles longues, 6-pans

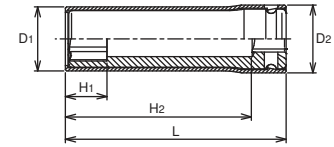

14300M (mm)	D ₁ (mm)	D ₂ (mm)	H ₁ (mm)	H ₂ (mm)	L (mm)	 (g)
10FR	19.8	28	11	63	81.3	145
12FR	22.3	28	13	63	81.3	167
13FR	23.5	28	14	63	81.3	167
14FR	24.8	28	15	63	81.3	179
16FR	27.3	33	17	63	81.3	237
17FR	28.5	33	18	63	81.3	237
New 18FR	29.8	33	18	62	81.3	237
19FR	31	33	20	62	81.3	245



14300G-FR  Impact Socket with Sliding Magnet
 Impact Steckschlüssel mit versenkbarem Magnet  
 Douilles Impact avec aimant, glissant pour écrous



14300G (mm)	D ₁ (mm)	D ₂ (mm)	H ₁ (mm)	H ₂ (mm)	L (mm)	 (g)
10FR	19.8	28	5.5	27	81.3	145
12FR	22.3	28	7	27	81.3	170
13FR	23.5	28	7.5	26	81.3	190
14FR	24.8	28	8	25	81.3	194
16FR	27.3	33	8.5	27.5	81.3	275
17FR	28.5	33	9	27.5	81.3	277
19FR	31	33	10	28.5	81.3	313

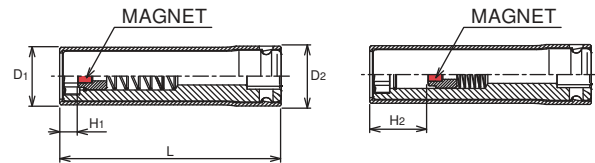

14760-P.FR Extension Bars
 Verlängerungen 
 Rallonges



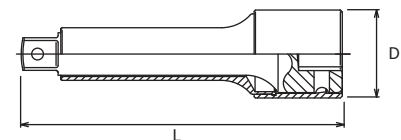

	D (mm)	L (mm)	 (g)
14760-75P.FR	34.2	75	195
14760-125P.FR	34.2	125	280
14760-250P.FR	34.2	250	480





 The protector could be broken with any impacts. Please handle with care.

113-75SV / -100SV / -150SV

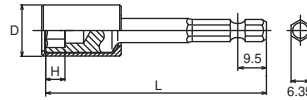
 Nut Setters
 Steckschlüssel Klingen
 Embouts pour écrous 





113-75 (mm)	D (mm)	H (mm)	L (mm)	 (g)
8SV	15.1	6	75	34
10SV	16.9	7	75	37
12SV	19.4	8	75	44
13SV	20.4	8	75	45
14SV	21.3	9	75	45

113-100 (mm)	D (mm)	H (mm)	L (mm)	 (g)
8SV	15.1	6	100	43
10SV	16.9	7	100	47
12SV	19.4	8	100	54
13SV	20.4	8	100	55
14SV	21.3	9	100	55



113-150 (mm)	D (mm)	H (mm)	L (mm)	 (g)
8SV	15.1	6	150	62
10SV	16.9	7	150	66
12SV	19.4	8	150	72
13SV	20.4	8	150	80
14SV	21.3	9	150	80

115-75 (mm)	D (mm)	H (mm)	L (mm)	 (g)
8SV	15.1	3.5	75	35
10SV	16.9	4.2	75	40
12SV	19.4	5.6	75	48
13SV	20.4	6	75	54
14SV	21.3	6.4	75	54

115-100 (mm)	D (mm)	H (mm)	L (mm)	 (g)
8SV	15.1	3.5	100	44
10SV	16.9	4.2	100	52
12SV	19.4	5.6	100	60
13SV	20.4	6	100	67
14SV	21.3	6.4	100	67



115-150 (mm)	D (mm)	H (mm)	L (mm)	 (g)
8SV	15.1	3.5	150	63
10SV	16.9	4.2	150	70
12SV	19.4	5.6	150	79
13SV	20.4	6	150	87
14SV	21.3	6.4	150	87

115-75SV / -100SV / -150SV

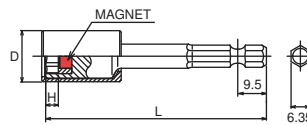
 Nut Setters with Magnet
 Steckschlüssel Klingen mit Magnet
 Embouts avec aimant pour écrous 



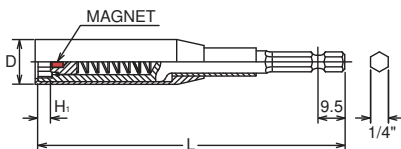
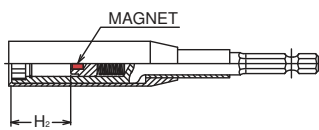

115G-100FR / -150FR / -200FR

 Nut Setters with sliding Magnet
 Steckschlüssel Klingen mit versenkbarem Magnet
 Embouts avec aimant, glissant pour écrous 



115G-100 (mm)	D (mm)	H ₁ (mm)	H ₂ (mm)	L (mm)	 (g)
8FR	15.1	4	26	100	55
10FR	16.9	4.5	26	100	60
12FR	19.3	6	26	100	80
13FR	20.4	6.5	25	100	85
14FR	21.3	7	24	100	85

115G-150 (mm)	D (mm)	H ₁ (mm)	H ₂ (mm)	L (mm)	 (g)
8FR	15.1	4	26	150	75
10FR	16.9	4.5	26	150	80
12FR	19.3	6	26	150	100
13FR	20.4	6.5	25	150	110
14FR	21.3	7	24	150	110

115G-200 (mm)	D (mm)	H ₁ (mm)	H ₂ (mm)	L (mm)	 (g)
8FR	15.1	4	26	200	90
10FR	16.9	4.5	26	200	100
12FR	19.3	6	26	200	125
13FR	20.4	6.5	25	200	135
14FR	21.3	7	24	200	135

 The protector could be broken with any impacts. Please handle with care.



Specifications or design of any product in this catalogue are subject to change without notice.

Wir behalten uns das Recht vor, jedes in diesem Katalog gezeigte Werkzeug, auch ohne vorherige Ankündigung, in Ausführung und Design ändern zu dürfen.

Nous nous réservons le droit de modifier les modèles et les dimensions des outils présentés dans ce catalogue et ce sans autre notification préalable.



REPLACEMENT

Remove a damaged Protector and put a new Protector on socket / Extension bar by pressing. For your safety, worn out or cracked Protector must be replaced.

AUSTAUSCH

Entfernen Sie defekte Protektoren und ersetzen Sie diese auf Ihrem Steckschlüssel/Verlängerung mittels einer Presse. Bitte tauschen Sie zu Ihrer Sicherheit verschlissene Protektoren aus !

REPLACEMENT

Retirez les protections défectueuses, remplacez celles-ci et fixez-les sur les douilles/rallonges à l'aide d'une presse. Pour votre sécurité remplacez toute protection défectueuse.

INDUSTRIAL SOCKETS

STECKSCHLÜSSEL, INDUSTRIE-AUSFÜHRUNG
CLÉS À DOUILLES, FINISSAGE INDUSTRIEL

1/4"

3/8"

1/2"



◆ INDUSTRIAL SOCKETS



Industrial sockets are thin walled sockets to be used on electric or pneumatic nut runners for assembly work only.

Bei den Industrial Steckschlüsseln handelt es sich um dünnwandige Werkzeuge, die ausschliesslich auf pneumatischen und elektrischen Drehschraubern (nicht schlagend) verwendet werden dürfen.

Les douilles Industrielles à paroi mince ne doivent être utilisées que sur des vis à fixer par visseuses (non-chocs).

22400M 6-point Sockets 6-kant Steckschlüssel Douilles 6-pans

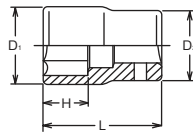

FLAT DRIVE®

22400M (mm)	D ₁ (mm)	D ₂ (mm)	H (mm)	L (mm)	(g)	(pcs.)
6	9.2	11.2	5.5	22	9	10
7	10.3	11.2	6	22	9	10
8	11.2	11.7	6.9	22	11	10
10	14.3	12.9	7.7	22	15	10
12	16.8	15.5	9.3	22	23	10
13	18	16.4	9.8	22	23	10

22425 TORX® Sockets TORX® Steckschlüssel Douilles TORX®

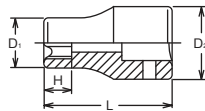

22425 (E)	D ₁ (mm)	D ₂ (mm)	H (mm)	L (mm)	(g)	(pcs.)
E 4	5.4	11.2	4.6	22	7	10
E 5	6.7	11.2	5.2	22	8	10
E 6	7.7	11.2	5.4	22	8	10
E 7	8.3	11.2	6.6	22	9	10
E 8	9.6	11.2	7	22	9	10
E10	11.3	12	8.2	22	10	10

TORX® (E)

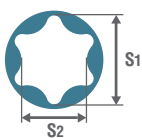

E	E4	E5	E6	E7	E8	E10	E11	E12	E14	E16	E18	E20	E22	E24	E26	E28	E30	E32
S ₁ (ref. mm)	3.7	4.6	5.6	6.1	7.4	9.3	9.9	11.0	12.8	14.6	16.5	18.3	20.1	22.0	23.7	25.5	27.3	29.0
S ₂ (ref. mm)	2.7	3.3	4.0	4.3	5.3	6.8	7.1	7.9	9.2	10.5	11.9	13.2	14.8	15.7	17.5	18.3	20.0	21.3

22300M / 22300A 6-point Sockets, deep 6-kant Steckschlüssel, lang Douilles longues, 6-pans

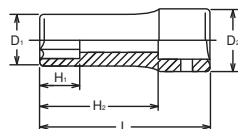

22300M (mm)	D ₁ (mm)	D ₂ (mm)	H ₁ (mm)	H ₂ (mm)	L (mm)	(g)	(pcs.)
7	10.3	11.2	8	40	50	24	10
8	11.2	11.7	9	40	50	28	10
10	14.3	12.9	11	39	50	33	10
12	16.8	15.5	13	39	50	50	10
13	18	16.4	14	39	50	50	10

22300A (inch)	D ₁ (mm)	D ₂ (mm)	H ₁ (mm)	H ₂ (mm)	L (mm)	(g)	(pcs.)
1/4	9.6	11.2	7	40	50	24	10
5/16	11.2	11.7	9	40	50	28	10
3/8	13.7	12.5	11	40	50	33	10

3/8" Steckschlüssel, Industrie-Ausführung Clés à douilles, finissage industriel

Z-SERIES
HAND
TITANIUM
ACCESSORIES
SCREWDRIVERS
IMPACT
SLEEVE-DRIVE
PROTECTOR
INDUSTRIAL
AUTOMOTIVE
MOTORCYCLE
CONSTRUCTION
SPARE PART

23400M (mm)	D ₁ (mm)	D ₂ (mm)	H (mm)	L (mm)	(g)	(pcs.)
6	9.9	17.3	6	26	20	10
7	10.8	17.3	6.5	26	20	10
8	12	17.3	6.9	26	22	10
10	14.5	17.3	8	26	24	10
11	15.8	17.3	9.3	26	25	10
12	16.8	17.3	9	26	25	10
13	18	17	9.4	26	24	10
14	19.5	18.5	11	27	31	10
15	21	19.5	11.5	28	39	10
16	22	20	12	28	42	10
17	23.5	21.5	12.5	29	51	10
18	24.6	22.5	13	30	51	10
19	26	23.5	13.5	30	53	10
21	28	26	14.5	32	77	10

23400A (inch)	D ₁ (mm)	D ₂ (mm)	H (mm)	L (mm)	(g)	(pcs.)
5/16	12	17.3	6.9	26	22	10
3/8	13.9	17.3	8	26	22	10
7/16	15.8	17.3	9.3	26	25	10
1/2	18	17	9.4	26	24	10
9/16	19.5	18.5	11	27	31	10
11/16	24.6	22.5	13	30	51	10
3/4	26	23.5	13.5	30	63	10

23405M (mm)	D ₁ (mm)	D ₂ (mm)	H (mm)	L (mm)	(g)	(pcs.)
8	12	17.3	6.9	26	22	10
10	14.5	17.3	8	26	24	10
12	16.8	17.3	9	26	25	10
14	19.5	18.5	11	27	31	10

23410M (mm)	D ₁ (mm)	D ₂ (mm)	H (mm)	L (mm)	(g)	(pcs.)
8	12	17.3	6.9	26	22	10
10	14.5	17.3	8	26	24	10
12	16.8	17.3	9	26	25	10
13	18	17	9.4	26	24	10
14	19.5	18.5	11	27	31	10
15	21	19.5	11.5	28	39	10
16	22	20	12	28	42	10
17	23.5	21.5	12.5	29	51	10
18	24.6	22.5	13	30	51	10
19	26	23.5	13.5	30	53	10

23425 (E)	D ₁ (mm)	D ₂ (mm)	H (mm)	L (mm)	(g)	(pcs.)
E 5	7	17.3	5.2	26	20	10
E 6	8.3	17.3	5.4	26	21	10
E 7	8.9	17.3	6.6	26	22	10
E 8	9.9	17.3	7	26	23	10
E10	12	17.3	8.2	26	24	10
E11	13.3	17.3	8.7	26	25	10
E12	14.5	17.3	9.3	26	26	10
E14	15.8	17.3	10.6	26	27	10
E16	18	17	11.8	26	27	10



23400M / 23400A

6-point Sockets
6-kant Steckschlüssel
Douilles 6-pans

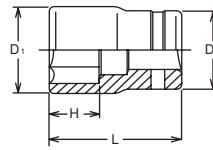

23405M

12-point Sockets
12-kant Steckschlüssel
Douilles 12-pans

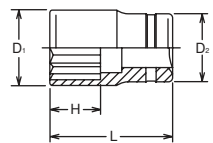

23410M

Surface Drive Sockets
Surface Drive Steckschlüssel
Douilles, Surface Drive

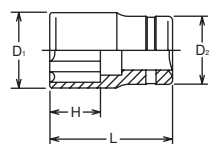

23425

TORX® Sockets
TORX® Steckschlüssel
Douilles TORX®

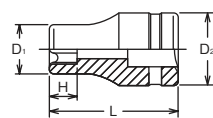

TORX® (E)

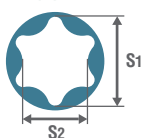

E	E4	E5	E6	E7	E8	E10	E11	E12	E14	E16	E18	E20	E22	E24	E26	E28	E30	E32
S ₁ (ref. mm)	3.7	4.6	5.6	6.1	7.4	9.3	9.9	11.0	12.8	14.6	16.5	18.3	20.1	22.0	23.7	25.5	27.3	29.0
S ₂ (ref. mm)	2.7	3.3	4.0	4.3	5.3	6.8	7.1	7.9	9.2	10.5	11.9	13.2	14.8	15.7	17.5	18.3	20.0	21.3

Industrial Sockets

Steckschlüssel, Industrie-Ausführung

Clés à douilles, finissage industriel

3/8"

Z-SERIES
HAND
TITANIUM
SCREWDRIVERS ACCESSORIES
IMPACT
SLEEVE-DRIVE
PROTECTOR
INDUSTRIAL
AUTOMOTIVE
MOTORCYCLE
CONSTRUCTION
SPARE PART

23300M / 23300A

6-point Sockets, deep
6-kant Steckschlüssel, lang
Douilles longues, 6-pans

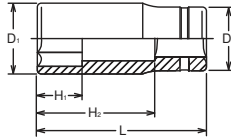

23300M (mm)	D ₁ (mm)	D ₂ (mm)	H ₁ (mm)	H ₂ (mm)	L (mm)	(g)	(pcs.)
7	10.6	17.4	8	41.5	55	40	10
8	12	17.4	9	41.5	55	45	10
10	14.5	17.4	11	41.5	55	52	10
11	16	17.2	12	41.5	55	55	10
12	16.8	17.2	13	41.5	55	58	10
13	18	17	14	41.5	55	57	10
14	20	18	16	41.5	55	68	10
15	21	20	16	40.5	55	78	10
16	22	20	17	40.5	55	79	10
17	23.5	22	18	40.5	55	96	10
18	24.5	23	19	39.5	55	96	10
19	25	24	20	39.5	55	102	10

23300A (inch)	D ₁ (mm)	D ₂ (mm)	H ₁ (mm)	H ₂ (mm)	L (mm)	(g)	(pcs.)
5/16	12	17.4	9	41.5	55	45	10
3/8	14	17.4	11	41.5	55	51	10
7/16	16	17.2	12	41.5	55	55	10
1/2	18	17	14	41.5	55	57	10
9/16	20	18	16	41.5	55	68	10
11/16	23.5	22	18	40.5	55	96	10
3/4	25	24	20	39.5	55	102	10

23305M

12-point Deep Sockets
12-kant Steckschlüssel, lang
Douilles longues 12-pans

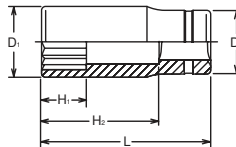

23305M (mm)	D ₁ (mm)	D ₂ (mm)	H ₁ (mm)	H ₂ (mm)	L (mm)	(g)	(pcs.)
8	12	17.4	9	41.5	55	45	10
10	14.5	17.4	11	41.5	55	52	10
12	16.8	17.2	13	41.5	55	58	10
14	20	18	16	41.5	55	68	10

23310M

Surface Drive Sockets, deep
Surface Drive Steckschlüssel, lang
Douilles longues, Surface Drive

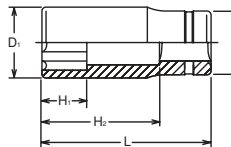

23310M (mm)	D ₁ (mm)	D ₂ (mm)	H ₁ (mm)	H ₂ (mm)	L (mm)	(g)	(pcs.)
8	12	17.4	9	41.5	55	45	10
10	14.5	17.4	11	41.5	55	52	10
12	16.8	17.2	13	41.5	55	58	10
13	18	17	14	41.5	55	57	10
14	20	18	16	41.5	55	68	10
15	21	20	16	40.5	55	80	10
17	23.5	22	18	40.5	55	96	10

23325

TORX® Deep Sockets
TORX® Steckschlüssel, lang
Douilles longues TORX®

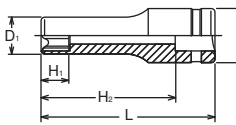

23325 (E)	D ₁ (mm)	D ₂ (mm)	H ₁ (mm)	H ₂ (mm)	L (mm)	(g)	(pcs.)
E 5	6.9	17.4	5.2	41.5	55	50	10
E 6	7.9	17.4	5.4	41.5	55	52	10
E 7	8.9	17.4	6.6	41.5	55	55	10
E 8	9.9	17.4	7	41.5	55	58	10
E10	11.8	17.2	8.2	41.5	55	60	10
E12	14.5	17.2	9.3	41.5	55	68	10
E14	15.7	17.2	10.6	41.5	55	77	10
E16	18	17	11.8	41.5	55	80	10

23760-P

Extension Bars
Verlängerungen
Rallonges



	D (mm)	L (mm)	(g)	(pcs.)
23760-75P	18	75	70	10
23760-125P	18	125	110	10
23760-250P	18	250	200	5

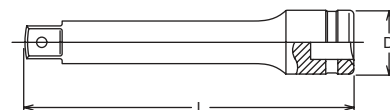

1/2"

Industrial Sockets
Steckschlüssel, Industrie-Ausführung
Clés à douilles, finissage industriel

24400M (mm)	D ₁ (mm)	D ₂ (mm)	H (mm)	L (mm)	(g)	(pcs.)
10	15.3	21	9	37	45	10
11	16.5	21	9.5	37	46	10
12	17.8	21	10	37	47	10
13	19	22	10.5	37	53	10
14	20.3	22	11	37	56	10
15	21.5	22	11.5	37	52	10
16	22.8	22	12	37	62	10
17	24.1	23	12.5	37	69	10
18	25.1	24	13	37	74	10
19	26.6	25	14	38	89	10
20	27.9	26	15	38	92	10
21	29.1	27	15.5	38	102	10
22	30.1	28	16	40	113	10
23	31.5	29	16.5	40	128	10
24	32.9	30	17	42	140	5
26	35	32	19	42	165	5
27	36.5	33	19.5	43	196	5
29	39	35	20.5	43	190	5
30	40	36	22	46	222	5
32	42.8	38	23	46	250	5

24400A (inch)	D ₁ (mm)	D ₂ (mm)	H (mm)	L (mm)	(g)	(pcs.)
7/16	16.5	21	9.5	37	46	10
1/2	19	22	10.5	37	53	10
9/16	20.3	22	11	37	56	10
5/8	22.9	22	12	37	62	10
3/4	26.6	25	14	38	89	10
15/16	32.9	30	17	42	140	10

24405M (mm)	D ₁ (mm)	D ₂ (mm)	H (mm)	L (mm)	(g)	(pcs.)
10	15.3	21	9	37	45	10
12	17.8	21	10	37	47	10
14	20.3	22	11	37	56	10
17	24.1	23	12.5	37	69	10
19	26.6	25	14	38	89	10

24410M (mm)	D ₁ (mm)	D ₂ (mm)	H (mm)	L (mm)	(g)	(pcs.)
10	15.3	21	9	37	45	10
12	17.8	21	10	37	47	10
13	19	22	10.5	37	53	10
14	20.3	22	11	37	56	10
15	21.5	22	11.5	37	52	10
16	22.8	22	12	37	62	10
17	24.1	23	12.5	37	69	10
18	25.1	24	13	37	74	10
19	26.6	25	14	38	89	10
21	29.1	27	15.5	38	102	10
22	30.1	28	16	40	113	10
24	32.9	30	17	42	140	10

24425 (E)	D ₁ (mm)	D ₂ (mm)	H (mm)	L (mm)	(g)	(pcs.)
E10	13.2	21	8.2	36	68	10
E12	14.6	21	9.3	37	70	10
E14	16.5	21	10.6	37	75	10
E16	19	21.9	11.8	37	80	10
E18	20.3	21.9	13	37	83	10
E20	22.9	22	14.4	37	121	10

TORX® (E)

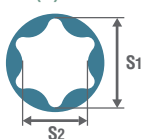

E	E4	E5	E6	E7	E8	E10	E11	E12	E14	E16	E18	E20	E22	E24	E26	E28	E30	E32
S ₁ (ref. mm)	3.7	4.6	5.6	6.1	7.4	9.3	9.9	11.0	12.8	14.6	16.5	18.3	20.1	22.0	23.7	25.5	27.3	29.0
S ₂ (ref. mm)	2.7	3.3	4.0	4.3	5.3	6.8	7.1	7.9	9.2	10.5	11.9	13.2	14.8	15.7	17.5	18.3	20.0	21.3



24400M / 24400A

6-point Sockets
6-kant Steckschlüssel
Douilles 6-pans

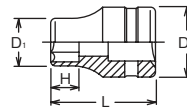

24405M

12-point Sockets
12-kant Steckschlüssel
Douilles 12-pans

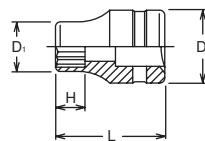

24410M

Surface Drive Sockets
Surface Drive Steckschlüssel
Douilles, Surface Drive

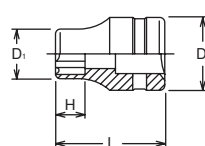

24425

TORX® Sockets
TORX® Steckschlüssel
Douilles TORX®

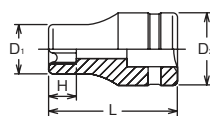

Industrial Sockets
Steckschlüssel, Industrie-Ausführung
Clés à douilles, finissage industriel

1/2"

Z-SERIES
HAND
TITANIUM
ACCESSORIES
SCREWDRIVERS
IMPACT
SLEEVE-DRIVE
PROTECTOR
INDUSTRIAL
AUTOMOTIVE
MOTORCYCLE
CONSTRUCTION
SPARE PART

24300M / 24300A

6-point Sockets, deep
6-kant Steckschlüssel, lang
Douilles longues, 6-pans

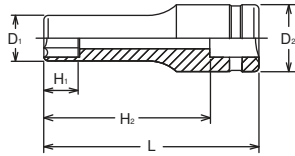

24300M (mm)	D ₁ (mm)	D ₂ (mm)	H ₁ (mm)	H ₂ (mm)	L (mm)	(g)	(pcs.)
10	15.3	21	11	59	77	91	10
11	16.5	21	12	59	77	95	10
12	17.8	21	13	59	77	99	10
13	19	21.8	14	59	77	107	10
14	20.3	21.8	16	59	77	118	10
15	21.5	21.8	16	59	77	123	10
16	22.8	22	17	59	77	141	10
17	24	23	18	59	77	150	10
18	25	24	19	59	77	164	10
19	26.5	25	20	58	77	177	10
20	27.8	26	21	58	77	178	10
21	29	27	23	58	77	187	10
22	30	28	27	57	77	202	10
24	32.8	30	27	57	77	252	10
27	36.5	33	28	56	77	303	10
30	40	36	34	55	77	342	10
32	42.8	38	34	55	77	405	10

24300A (inch)	D ₁ (mm)	D ₂ (mm)	H ₁ (mm)	H ₂ (mm)	L (mm)	(g)	(pcs.)
7/16	16.5	21	12	59	77	95	10
1/2	19	21.8	14	59	77	107	10
9/16	20.3	21.8	15	59	77	118	10
5/8	22.8	22	17	59	77	141	10
21/32	24	23	18	59	77	150	10
11/16	25	24	19	59	77	164	10
3/4	26.5	25	20	58	77	177	10
13/16	29	27	23	58	77	187	10
15/16	32.8	30	27	57	77	252	10

24305M

12-point Deep Sockets
12-kant Steckschlüssel, lang
Douilles longues 12-pans

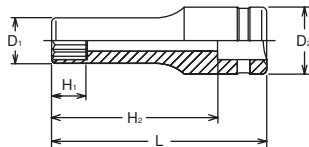

24305M (mm)	D ₁ (mm)	D ₂ (mm)	H ₁ (mm)	H ₂ (mm)	L (mm)	(g)	(pcs.)
10	15.3	21	11	59	77	91	10
12	17.8	21	13	59	77	99	10
14	20.3	21.8	16	59	77	118	10
17	24	23	18	59	77	150	10
19	26.5	25	20	58	77	177	10

24310M

Surface Drive Sockets, deep
Surface Drive Steckschlüssel, lang
Douilles longues, Surface Drive

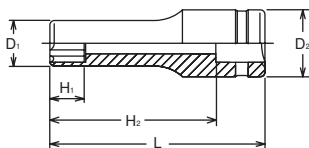

24310M (mm)	D ₁ (mm)	D ₂ (mm)	H ₁ (mm)	H ₂ (mm)	L (mm)	(g)	(pcs.)
10	15.3	21	11	59	77	91	10
12	17.8	21	13	59	77	99	10
13	19	21.8	14	59	77	107	10
14	20.3	21.8	16	59	77	118	10
15	21.5	21.8	16	59	77	123	10
16	22.8	22	17	59	77	141	10
17	24	23	18	59	77	150	10
18	25	24	19	59	77	160	10
19	26.5	25	20	58	77	177	10
21	29	27	23	58	77	187	10
22	30	28	27	57	77	202	10
24	32.8	30	27	57	77	250	10

24760-P

Extension Bars
Verlängerungen
Rallonges



	D (mm)	L (mm)	(g)	(pcs.)
24760-75P	24	75	140	10
24760-125P	24	125	200	5
24760-250P	24	250	370	5

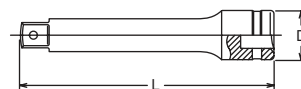

AUTOMOTIVE TOOLS
WERKZEUGE FÜR KFZ UND NUTZFAHRZEUGE
OUTILS POUR POIDS LOURDS ET VÉHICULES UTILITAIRES



Z-SERIES
 HAND
 TITANIUM
 SCREWDRIVERS ACCESSORIES
 IMPACT
 SLEEVE-DRIVE
 PROTECTOR
 INDUSTRIAL
 AUTOMOTIVE
 MOTORCYCLE
 CONSTRUCTION
 SPARE PART

3300C / 4300C Spark Plug Sockets with Spring Clips
 Zündkerzen-Schlüssel mit Haltefeder
 Douille avec ressorts de retenue pour bougies

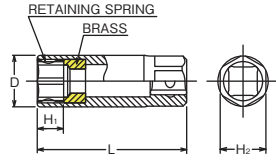

3300C (mm)		D (mm)	H ₁ (mm)	H ₂ (mm)	L (mm)	(g)	(pcs.)
13		17.5	11	17	70	66	10
14	3/8"	19	11	17	70	82	10
16		20.5	13	17	70	91	10
18		23.9	12	21	70	140	10
20.8		26.9	13.5	22	70	132	10

4300C (mm)		D (mm)	H ₁ (mm)	H ₂ (mm)	L (mm)	(g)	(pcs.)
16	1/2"	21	13	21	70	101	10
18		23.9	12	21	70	132	10
20.8		26.9	13.5	22	70	130	10

Spring clip type spark plug sockets caused deforming the clip if it would be used with shallow engagement.

3300CB Spark Plug Socket (BMW)
 Zündkerzen-Schlüssel (BMW)
 Douille pour bougies (BMW)

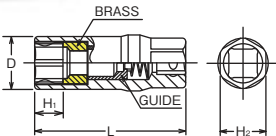

3300CB (mm)		D (mm)	H ₁ (mm)	H ₂ (mm)	L (mm)	(g)	(pcs.)
16	3/8"	22.8	13	19	65	118	10

Spring clip type spark plug sockets caused deforming the clip if it would be used with shallow engagement.

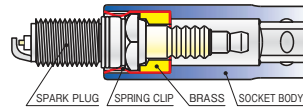

SPARK PLUG SOCKETS with SPRING CLIP
 An internal brass guide holds the clips in place, which ensures perfect alignment of the spark plug into the threaded plug hole of the cylinder head, thus preventing thread damage. The brass guide also eliminates stress loading and possible damage to the ceramic insulator of the spark plug.

3300P Spark Plug Socket with Magnet
 Zündkerzensteckschlüssel mit Magnet
 Douille pour bougies, avec aimant

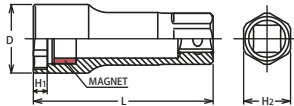

3300P (mm)		D (mm)	H ₁ (mm)	H ₂ (mm)	L (mm)	(g)	(pcs.)
New 19	3/8"	24.8	5	17	65	88	10

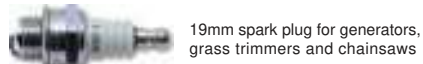

The magnet could be broken with any impacts. Please handle with care.

3305P Spark Plug Socket with Magnet, 12-pt. opening
 Zündkerzensteckschlüssel mit Magnet, 12-kant
 Douille pour bougies, avec aimant, 12-pans

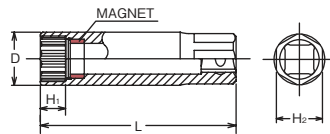

3305P (mm)		D (mm)	H ₁ (mm)	H ₂ (mm)	L (mm)	(g)	(pcs.)
New 12	3/8"	16.5	6.3	-	70	78	10
14		19	8	17	70	87	10
16		20.5	8	17	70	100	10

Spark Plug Socket with Magnet, 12-pt. opening: 3305P-14



The magnet could be broken with any impacts. Please handle with care.

3300S / 4300S Spark Plug Sockets with Rubber
 Zündkerzen-Schlüssel mit Gummiemsetz
 Douille pour bougies avec caoutchouc

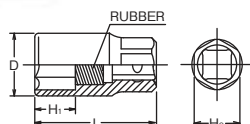

3300S (mm)		D (mm)	H ₁ (mm)	H ₂ (mm)	L (mm)	(g)	(pcs.)
16	3/8"	20.9	19	17	70	100	10
18		23.9	21	21	70	145	10
20.8		26.9	27	22	70	140	10

4300S (mm)		D (mm)	H ₁ (mm)	H ₂ (mm)	L (mm)	(g)	(pcs.)
16	1/2"	21	19	21	70	100	10
18		23.9	21	21	70	130	10
20.8		26.9	27	22	70	135	10

3300C-180 (mm)		D ₁ (mm)	D ₂ (mm)	H (mm)	L (mm)		
14	3/8"	19	18	11	180	205	5
16		20.5	18	13	180	220	5
20.8		26.9	18	13.5	180	260	5

3300C-250 (mm)		D ₁ (mm)	D ₂ (mm)	H (mm)	L (mm)		
14	3/8"	19	18	11	250	271	5
16		20.5	18	13	250	290	5
20.8		26.9	18	13.5	250	340	5

Spring clip type spark plug sockets caused deforming the clip if it would be used with shallow engagement.



3300C-180 / -250

Spark Plug Sockets with Spring Clips
Zündkerzen-Schlüssel mit Haltefedern
Douille avec ressorts de retenue pour bougies

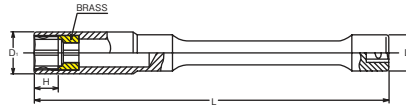

3305P-250

Spark Plug Socket with Magnet, 12pt. opening
Zündkerzensteckschlüssel mit Magnet, 12-kant
Douille pour bougies, avec aimant, 12-pans

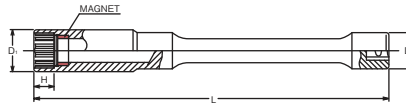

3305P-250 (mm)		D ₁ (mm)	D ₂ (mm)	H (mm)	L (mm)		
14	3/8"	19	18	8	250	250	5

The magnet could be broken with any impacts. Please handle with care.

3340C (mm)		D ₁ (mm)	D ₂ (mm)	H (mm)	L (mm)		
14	3/8"	19	19	11	88	109	10
16		21	19	13	88	122	10
18		23.9	19	12	88	145	10
20.8		26.8	19	13.5	88	174	10

4340C (mm)		D ₁ (mm)	D ₂ (mm)	H (mm)	L (mm)		
16	1/2"	21	25	13	107	220	10
20.8		26.8	25	13.5	107	250	10

Spring clip type spark plug sockets caused deforming the clip if it would be used with shallow engagement.

3340C

Universal Spark Plug Sockets with Spring Clips
Gelenk-Zündkerzenschlüssel mit Haltefeder
Douille articulée avec ressorts de retenue pour bougies

4340C

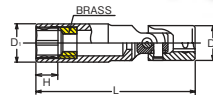

3345P

Universal Spark Plug Socket with Magnet, 12-point opening
Gelenk-Zündkerzensteckschlüssel mit Magnet, 12-kant Ausführung
Clé pour bougies à déclenchement articulée avec aimant, 12 pans

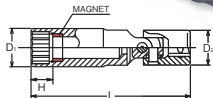

3345P (mm)		D ₁ (mm)	D ₂ (mm)	H (mm)	L (mm)		
14	3/8"	19	19	8	88	110	10

The magnet could be broken with any impacts. Please handle with care.



127C

T-type Universal Spark Plug Socket Wrench
T-Griff mit Gelenk-Zündkerzenschlüssel
Poignée en T avec douille universelle pour bougies

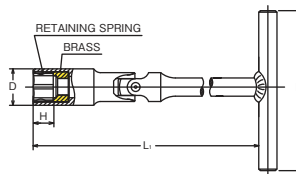
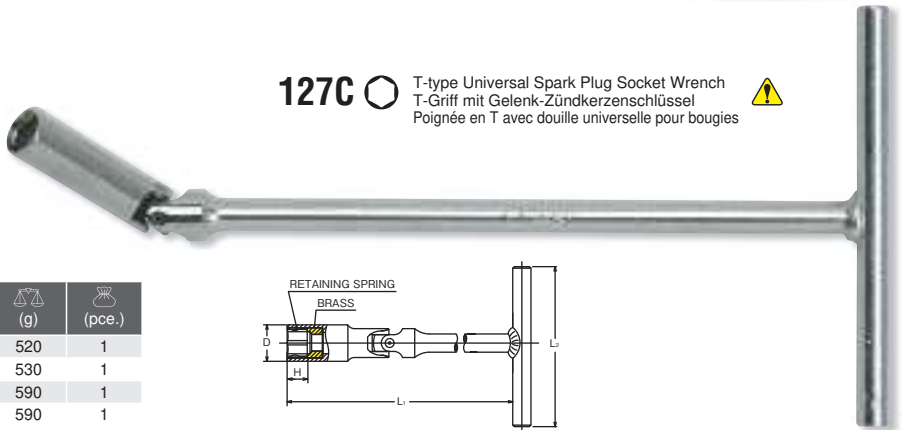

127C-315 (mm)	D (mm)	H (mm)	L ₁ (mm)	L ₂ (mm)		
14	19	11	315	150	520	1
16	21	13	315	150	530	1
18	23.9	12	315	150	590	1
20.8	26.8	13.5	315	150	590	1

Spring clip type spark plug sockets caused deforming the clip if it would be used with shallow engagement.

Z-SERIES
 HAND
 TITANIUM
 SCREWDRIVERS ACCESSORIES
 IMPACT
 SLEEVE-DRIVE
 PROTECTOR
 INDUSTRIAL
 AUTOMOTIVE
 MOTORCYCLE
 CONSTRUCTION
 SPARE PART

3751N Torque Ratchet for Spark plugs
 Drehmoment-Knarre für Zündkerzen
 Cliquet pour bougies à déclenchement 25Nm



3751J Torque Ratchet for Spark plugs
 Drehmoment-Knarre für Zündkerzen
 Cliquet pour bougies à déclenchement 25Nm



TORQUE RATCHET

The torque is set at 25Nm. When the torque is loaded higher than 25Nm, the gear slips and no increased torque is transmitted. Cylinder heads and spark plugs are protected by this mechanism.

DREHMOMENT-KNARRE

Die Knarre ist auf ein Drehmoment von 25Nm eingestellt. Ist das Drehmoment von 25Nm erreicht, springt das innere Getriebe über. Dies schützt die Zündkerzengewinde am Zylinderkopf.

CLIQUET À DÉCLENCHEMENT

Le cliquet est fixé à un torque d'une capacité maximale de 25NM. Une fois les 25NM atteints, ce mécanisme évite tout dépassement du cliquet.

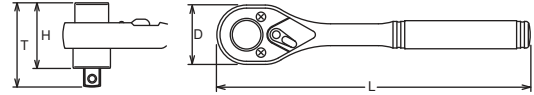

	□	D (mm)	T (mm)	H (mm)	L (mm)	(g)	(pce.)
3751N-25	3/8"	34	57	43	178	320	1
3751J-25	3/8"	34	57	43	178	320	1

3225A Set for Torque Controlled Installation of Spark Plugs
 Set zur Drehmoment kontrollierten Montage von Zündkerzen
 Jeu qui permet la rotation contrôlée lors du montage des bougies à déclenchement



3225A		4 Pieces Set/△=960g	
METAL CASE:W215×H80×T47mm			
Sockets		Accessories	
○ 3300C Spark Plug Sockets 16, 20.8		3751J-25	
		3763-125	

3701-20Nm / -30Nm Torque Adaptors 20Nm / 30Nm
 Drehmoment-Verbindungsstücke 20Nm / 30Nm
 Adaptateurs dynamométriques 20Nm / 30Nm

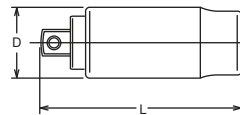

3701	□	D (mm)	L (mm)	(g)	(pce.)
20Nm	3/8"	25.5	75	178	1
30Nm	3/8"	28	75	220	1



2350G-PSG (mm)		D ₁ (mm)	D ₂ (mm)	H ₁ (mm)	H ₂ (mm)	L (mm)		
12	1/4"	16.5	15.5	12	41	50	41	10



2350G-12PSG

NUT GRIP® Sockets for PSG-Glow Plugs
Steckschlüssel für PSG-Glühkerzen
Douille pour bougies PSG

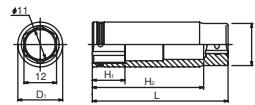

3341G-70 (mm)		D ₁ (mm)	D ₂ (mm)	H (mm)	L (mm)		
10	3/8"	14.5	19	6	70	76	10
11		15.8	19	6	70	80	10
12		17	19	6	70	85	10

3341G-70 / -89

Universal PSG Glow Plug Socket with NUT GRIP®
Gelenksteckschlüssel für PSG-Glühkerzen mit 2fach Kugelhalterung
Douille articulée pour bougies de préchauffement PSG, avec le système de billes de retenue, double.



3341G-89 (mm)		D ₁ (mm)	D ₂ (mm)	H (mm)	L (mm)		
8	3/8"	12	19	7.5	89	82	10
9		13.3	19	7.5	89	87	10
10		14.5	19	6	89	92	10
12(DP52)		17	19	14	89	101	10

GLOW PLUG SOCKETS, NUT GRIP®

Twin balls at the 6-point opening hold bolt/nut tightly for safe and reliable work.

Die zwei Kugeln in der 6-kant Öffnung unserer NUT GRIP® Glühkerzensteckschlüssel halten die Zündkerze sicher im Steckschlüssel. Dies erlaubt ein Arbeiten auch an schwer zugänglichen Stellen.

Les deux billes se trouvant dans l'ouverture de notre NUT GRIP® (6 pans) pour bougies de préchauffement, maintiennent la bougie de déclenchement dans la douille. Ceci permet l'accès dans les endroits difficilement accessibles.



3342G-150 (mm)		D ₁ (mm)	D ₂ (mm)	H (mm)	L (mm)		
8	3/8"	12	18	7.5	150	137	10

3342G-150

Deep length universal Glow Plug Socket
Extra langer Glühkerzen-Steckschlüssel mit Gelenk
Douille articulée pour bougies de préchauffement, extra longue

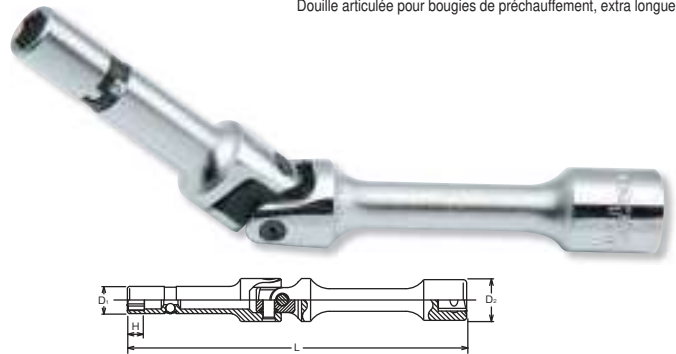

178-10H (mm)	D (mm)	H ₁ (mm)	H ₂ (mm)	S (mm)	L (mm)		
9	13	6.5	10	6.7	50	16	10

178-10H

For Glow Plugs
Für Glühkerzen
Pour bougies de préchauffement



144KM (mm)	L (mm)	D ₁ (mm)	D ₂ (mm)	C (mm)		
8	200	22.7	7.5	95	1	
12	200	22.7	7.5	102	1	

144KM

For Glow Plugs
Für Glühkerzen
Pour bougies de préchauffement

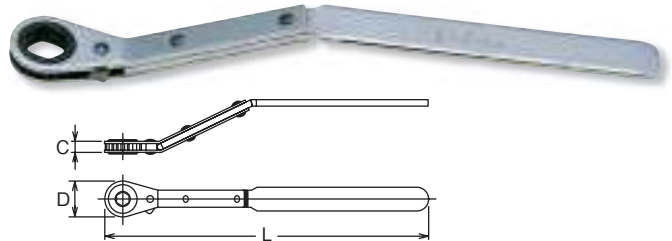

148KM (mm)	L (mm)	D ₁ (mm)	D ₂ (mm)	C (mm)		
8S×12	245	23.6	24.6	9	187	1

148KM

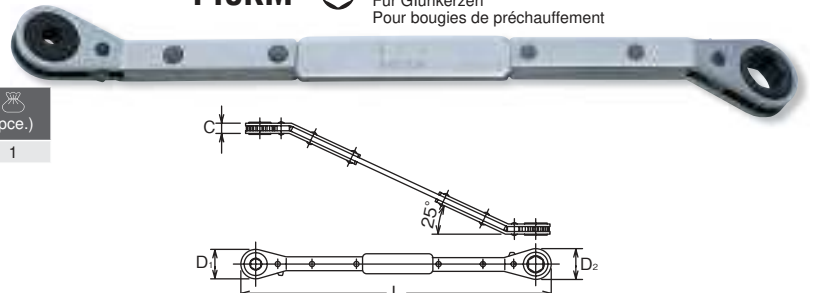

For Glow Plugs
Für Glühkerzen
Pour bougies de préchauffement

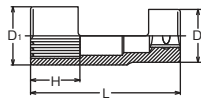

Z-SERIES
 HAND
 TITANIUM
 SCREWDRIVERS ACCESSORIES
 IMPACT
 SLEEVE-DRIVE
 PROTECTOR
 INDUSTRIAL
 AUTOMOTIVE
 MOTORCYCLE
 CONSTRUCTION
 SPARE PART

SP4305M-77  Socket for Diesel engine injectors
 Steckschlüssel für Diesel-Einspritzdüsen
 Douilles spéciales pour injecteurs





SP4305M-77 (mm)		D ₁ (mm)	D ₂ (mm)	H (mm)	L (mm)	 (g)	 (pcs.)
27	1/2"	36.5	33	28	77	212	10

SP4305M.77-27
 For fuel injection pump of BMW diesel cars.

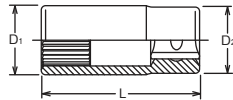
4133  Socket for Diesel engine injectors
 Steckschlüssel für Diesel-Einspritzdüsen
 Douilles spéciales pour injecteurs





		D ₁ (mm)	D ₂ (mm)	L (mm)	 (g)	 (pcs.)
4133	1/2"	23.9	23	55	86	10

4133
 For fuel injection pump of M.B diesel cars.

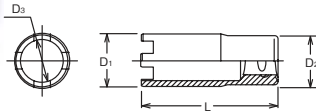
4122-72 Diesel Injection Holder Nut Socket
 Steckschlüssel für Einspritzdüsen
 Douilles pour injecteur diesel



4122-72 (mm)		D ₁ (mm)	D ₂ (mm)	D ₃ (mm)	L (mm)	 (g)	 (pcs.)
22	1/2"	28.5	27	22	72	150	10

4122.72-22
 For M.B Trucks, Holder nut of injection post.

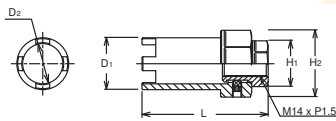

SP4122-69 Diesel Injection Holder Nut Socket
 Steckschlüssel für Einspritzdüsen
 Douilles pour injecteur diesel

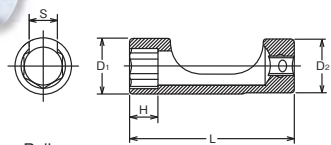

SP4122-69 (mm)	D ₁ (mm)	D ₂ (mm)	H ₁ (mm)	H ₂ (mm)	L (mm)	 (g)	 (pcs.)
22	28.4	22	22	32	69	185	5

3300FN  Flare Nut Sockets
 Geschlitzte Steckschlüssel für Überwurfmuttern
 Douilles à tuyauter



3300FN (mm)		D ₁ (mm)	D ₂ (mm)	H (mm)	L (mm)	S (mm)	 (g)	 (pcs.)
8	3/8"	14.5	17.3	6	53	6.4	38	10
9		16	17.3	7	53	6.8	41	10
10		16.8	17.2	7.5	53	7.2	42	10
11		18	17	8.5	53	8.3	42	10
12		20	18	9	53	8.8	50	10
13		21.1	20	9.5	62	9.4	66	10
14		22	20	10.5	62	10.5	66	10
15		23	22	11	70	11.5	82	10
16		24	23	11.5	70	12	90	10
17		25	24	12.5	80	13	110	10
18		27	25	13	80	13.5	120	10
19		28	26	14	80	14.5	130	10
22	32	29.5	16	80	16	180	10	
24	34.5	31.5	17	80	17	200	10	



RS3300FN/8	8 Pieces Set/Rail 200mm	 (g)
9, 10, 11, 13, 14, 16, 17, 19		600

RS3300FN/8   Socket Set on Rail
 Steckschlüsselsatz auf Schiene
 Jeu de douilles sur rail

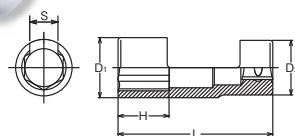

SP4300M-85  Special socket for Lambda Probes
 Spezialsteckschlüssel für Lambda Sonden
SP4300M-110  Douilles spéciales pour sonde Lambda



		D ₁ (mm)	D ₂ (mm)	H (mm)	L (mm)	S (mm)	 (g)	 (pcs.)
SP4300M.85-22	1/2"	33	30	29	85	8	228	10
SP4300M.110-22		33	30	34	110	8	279	5



Socket for Lambda Probes
 Open section allows for use with wire/connector.

Z-SERIES
HAND
TITANIUM
ACCESSORIES
SCREWDRIVERS
IMPACT
SLEEVE-DRIVE
PROTECTOR
INDUSTRIAL
AUTOMOTIVE
MOTORCYCLE
CONSTRUCTION
SPARE PART

4300H (mm)		D ₁ (mm)	D ₂ (mm)	H ₁ (mm)	H ₂ (mm)	H ₃ (mm)	L (mm)	(g)	(pcs.)
24	1/2"	32.5	27	17	40	24	57	157	10
26		35	27	19	40	24	57	170	10
27		36.1	27	19.5	40	24	57	175	10

4300H series
Removes and installs oil pressure switches

4300H (mm)		D ₁ (mm)	D ₂ (mm)	H ₁ (mm)	H ₂ (mm)	L (mm)	(g)	(pcs.)
27(8P)	1/2"	34	27	18.5	37	57	152	10

4300H(8P) series
Socket for Switches, Mercedes Benz and MAN

4010M-100 (mm)		D (mm)	H (mm)	L (mm)	(g)	(pcs.)
8(12P)	1/2"	23	63.5	100	132	10
10(12P)		23	63.5	100	135	10

4010M-120 (mm)		D (mm)	H (mm)	L (mm)	(g)	(pcs.)
8(12P)	1/2"	23	83.5	120	151	10
10(12P)		23	83.5	120	155	10



Cylinder head bolt socket for TOYOTA
4010M(12P) is Double Hex bit socket.
XZN(Triple Square) bit socket has different shape.

ST4027.140 (mm)		D (mm)	H (mm)	L (mm)	(g)	(pcs.)
ST4027.140	1/2"	23	103.5	140	155	10



Head Bolt Bit Socket for VW/AUDI
ST4027-140 can not substitute with 3027, 4027-CV bit series.

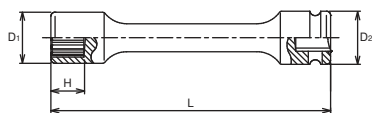

13145M-150 (12P) (mm)		D ₁ (mm)	D ₂ (mm)	H (mm)	L (mm)	(g)	(pcs.)	
10	3/8"	15.8	19	10	150	120	1	*1
12		18.3	19	12	150	128	1	*1

*1 C-Ring=C31, Pin/O-Ring=A31/B31 → P256-257

4300H Oil Pressure Switch Sockets
Steckschlüssel für Öldruckschalter
Douilles pour interrupteur, pression d'huile

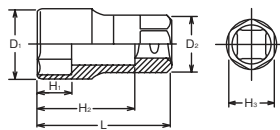

4300H (8P) 8-point Sockets
8-kant Steckschlüssel
Douilles 8-pans

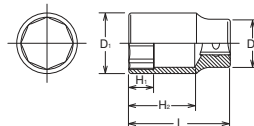

4010M-100 / -120 (12P)

Bit Sockets for Double Inhex Screws (12-point)
Steckschlüssel für Innenzwölfkant-Schrauben
Douilles à 6-pans doubles

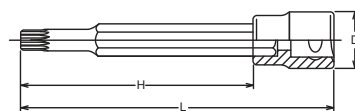

ST4027-140 Head Bolt Bit Socket for VW/AUDI
Bit Steckschlüssel für Zylinderkopfschrauben VW/AUDI
Douilles tournevis spéciales pour boulons de culasse VW/AUDI

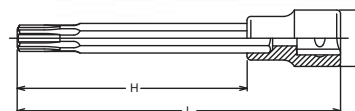

13145M-150 / -200 (12P) Extra Long Sockets
Schaftsteckschlüssel
Douilles, série allongée



13145M.200 (12P) (mm)		D ₁ (mm)	D ₂ (mm)	H (mm)	L (mm)	(g)	(pcs.)	
10	3/8"	15.8	19	10	200	151	1	*1
12		18.3	19	12	200	159	1	*1

*1 C-Ring=C31, Pin/O-Ring=A31/B31 → P256-257

16305M (mm)		D ₁ (mm)	D ₂ (mm)	H ₁ (mm)	H ₂ (mm)	L (mm)	(g)	(pcs.)	
14	3/4"	26.3	44	14	74	100	500	2	*1
17		30	44	17	74	100	544	2	*1
19		32.5	44	19	74	100	655	2	*1
22		36.3	44	22	74	100	700	2	*1

*1 C-Ring=C61, Pin/O-Ring=A61/B61 → P256-257

16305M 12-point Sockets, deep
12-kant Steckschlüssel, lang
Douilles longues, 12-pans

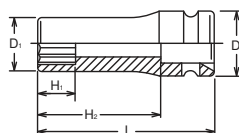

Z-SERIES
 HAND
 TITANIUM
 ACCESSORIES
 SCREWDRIVERS
 IMPACT
 SLEEVE-DRIVE
 PROTECTOR
 INDUSTRIAL
 AUTOMOTIVE
 MOTORCYCLE
 CONSTRUCTION
 SPARE PART

4109M  Double 4-point Sockets
 Doppelvierkant Steckschlüssel
 Douilles 4-pans, doubles

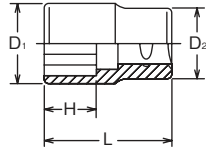

4109M (mm)		D ₁ (mm)	D ₂ (mm)	H (mm)	L (mm)	(g)	(pcs.)
14	1/2"	26.8	26	11	38	110	10
17		30	28	12.5	40	140	10
19		31.5	29	14	40	150	10
21.5		35	32	16	40	170	10
23		37	34	16.5	43	180	10

4109M series
 For Lubrication service

4111M  6-point Sockets
 6-kant Steckschlüssel
 Douilles 6-pans

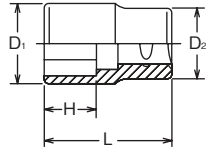

4111M (mm)		D ₁ (mm)	D ₂ (mm)	H (mm)	L (mm)	(g)	(pcs.)
24	1/2"	32	30	17	40	133	10

4111M
 For Lubrication service

4020-60 (MH)  Bit Socket for Triple Square with hole
 Steckschlüssel für XZN-Schrauben mit Loch
 Douilles tournevis avec trou pour empreinte XZN

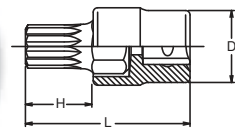

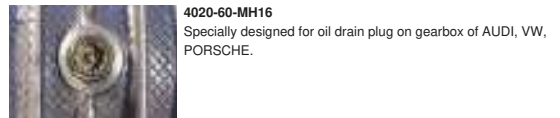

4020-60 (XZN)		D (mm)	H (mm)	L (mm)	(g)	(pcs.)
MH16	1/2"	24	20	60	135	10

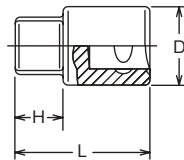

3110M / 3110A  4-point Male Sockets
 Öldienst-Steckschlüssel
 Douilles mâles 4-pans





3110M (mm)		D (mm)	H (mm)	L (mm)	(g)	(pcs.)
6	3/8"	18	10	28	30	10
8		18	10	28	30	10
10		18	10	28	33	10
12		18	10	28	37	10

3110A (inch)		D (mm)	H (mm)	L (mm)	(g)	(pcs.)
5/16	3/8"	18	10	28	30	10
3/8		18	10	28	33	10
1/2		18	10	28	37	10

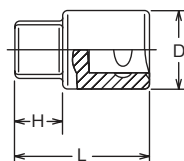
4110M / 4110A  4-point Male Sockets
 Öldienst-Steckschlüssel, Vierkant
 Douilles mâles 4-pans



4110M (mm)		D (mm)	H (mm)	L (mm)	(g)	(pcs.)
8	1/2"	24	10	32	57	10
10		24	10	32	62	10
10.5		24	10	32	64	10
12		24	10	32	64	10
13		24	10	32	66	10
13.5		24	10	32	67	10
19		25	15	37	101	10
20		26	15	37	114	10

4110A (inch)		D (mm)	H (mm)	L (mm)	(g)	(pcs.)
3/8	1/2"	24	10	32	62	10
1/2		24	10	32	64	10

158  For Lubrication Service
Schmierdienst-Werkzeuge
Service lubrification-vidange



158 (mm)	L ₁ (mm)	L ₂ (mm)	d (mm)	(g)	(pcs.)
8S×10S	63	230	13	319	1

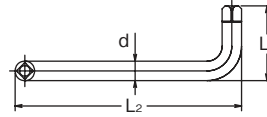

3012M-25 (mm)		D (mm)	L (mm)	(g)	(pcs.)
14	3/8"	19	25	30	10
17		19	25	30	10

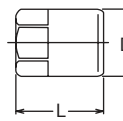

3012M-25  Inhex Sockets
Steckschlüssel für Innensechskant-Schrauben
Douilles tournevis pour vis 6-pans creux



4202 7 Pieces Set/ =426g

METAL CASE:W190×H59×T45mm



Sockets

-  **106 Drain Plug Keys**
8S×10S, 8H×3/8H, 10H×11H, 12H×13H, 14H×17H, 19H
-  **4102 Drain Plug Key Adaptor**

4202 Drain Plug Keys Set
Öldienst-Satz
Jeu d'embouts pour le montage et démontage des bouchons de vidange



106 (mm)	H ₁ (mm)	H ₂ (mm)	H ₃ (mm)	L (mm)	(g)	(pcs.)
8S×10S	8	8	17	32	40	10
8H×3/8H	8	8	17	32	38	10
10H×11H	8	8	17	32	42	10
12H×13H	8	8	17	32	47	10
14H×17H	8	8	17	32	55	10
19H	-	8	17	24	49	10

106   4-point / 6-point Male bits
Innenvierkant / Innensechskantsteckschlüssel
Embouts mâles 4-pans / 6-pans

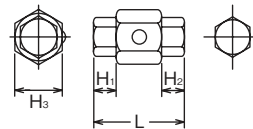

4102 (mm)		D ₁ (mm)	D ₂ (mm)	H (mm)	L (mm)	(g)	(pcs.)
17	1/2"	25	24	16	40	82	10

4102  Adaptor for 106 Drain plug key
Halter für Öldienst-Einsätze 106
Porte embouts pour 106

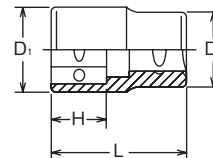

3400M-24 (mm)		D ₁ (mm)	D ₂ (mm)	H (mm)	L (mm)	(g)	(pcs.)
27	3/8"	36.5	21.5	13.5	24	76	10
30		40	25	13.5	24	91	10
32		42.8	28	13.5	24	108	10
36		47.2	32	13.5	24	135	10

3400M-24  Extra short 6-point Sockets for Oil-Filter Service
Extra kurze Steckschlüssel für Ölfilter
Douille extra courte pour filtre à huile

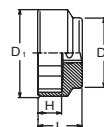

Z-SERIES
 HAND
 TITANIUM
 SCREWDRIVERS ACCESSORIES
 IMPACT
 SLEEVE-DRIVE
 PROTECTOR
 INDUSTRIAL
 AUTOMOTIVE
 MOTORCYCLE
 CONSTRUCTION
 SPARE PART

1206  Push and Pull-Ratchet
 Hub Knarre
 Clé à cliquet de levage



1206		3 Pieces Set/△=320g	
CARDBOARD BOX			
Sockets		Accessory	
 150.14H Sockets 12, 14	154K-14		

154K  Push and Pull-Ratchets
 Hub Knarre
 Clé à cliquet de levage

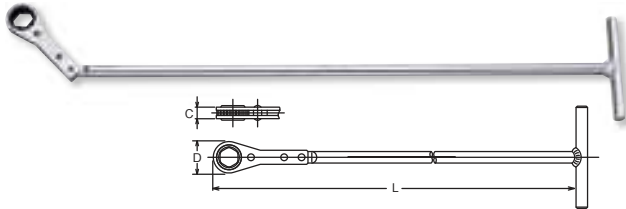

154K (mm)	L (mm)	D (mm)	C (mm)	(g)	(pcs.)
14	480	24.6	9	280	1

150-14H  Socket, For 154K
 Einsätze für 154K
 Douilles pour 154K



150-14H (mm)	D (mm)	H (mm)	L (mm)	(g)	(pcs.)
10	16	5	17	16	10
12	17.3	5	18	14	10
14	19.2	7	21	17	10

145LH3/8F  Belt Tension Pulley Wrench
 Knarren-Ringschlüssel für Riemen-Spannrolle
 Clé multicrân à cliquet pour galet-tendeur 



145LH3/8F (LH-S)		L (mm)	D (mm)	C (mm)	(g)	(pcs.)
10S	3/8"	100	25	15.5	90	10

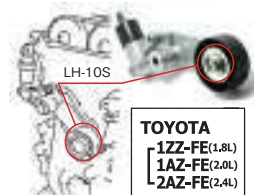

Belt Tension Pulley Wrench
 For LH-10S bolt on TOYOTA engines 1ZZ (1.8L), 1AZ (2.0L) and 2AZ (2.4L), belt tension pulley.

 This item has less strength due to the special design.

4282 1/2" Sq.Dr. Generator Service Set
 1/2" Lichtmaschinen-Service Satz
 Jeu 1/2" pour l'entretien des générateurs électriques



4282		4 Pieces Set/△=449g	
PLASTIC BAG			
Sockets			
 1/2"	4020.100-M10 4020.140-M10		
 1/2"	4025.100R-T50		
	185		



Generator Service Set
 For removing and installing belt pulley at the generator.

1210E Door Hinge Wrench Set
Montagesatz für Kfz-Türscharniere
Jeux d'outils spéciaux pour charnières de portes



1210E		11 Pieces Set/△=460g
PLASTIC BAG		
Sockets	Accessory	
<ul style="list-style-type: none"> 179B.12H Sockets 10, 12, 13 179B.12H XZN Bits M8, M10, M12 179B.12H TORX® Bits T40, T45, T50 179B.12H Hex Bit 8 	145KD-12	

3247 4 Pieces Set/△=385g
PLASTIC BAG

Sockets	
<ul style="list-style-type: none"> 3/8" 3025.160 Tamper-resistant TORX® Bit Sockets T27H, T30H, T40H, T50H 	



For Air Bag
For air-bag unit in hard to reach places in or around the steering wheel.

Tamper Resistant TORX® Bit Sockets have less strength.

3247 Bit Socket Set
Schraubendreher-Steckschlüssel Satz
Jeu de douilles de vissage



3300M/4-L120 4 Pieces Set/△=477g
PLASTIC BAG

Sockets	
<ul style="list-style-type: none"> 3/8" 3300M(L120) 6-pt. Extra Deep Sockets 8, 10, 12, 14 	



Extra Deep Socket
Extra deep socket can be used to fasten or loosen longer bolts such as Bumper bolt and Door hinge etc.

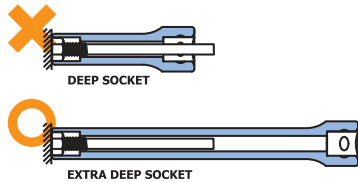

3300M/4-L120 Socket Set
Steckschlüssel Satz
Jeu de clés à douille



3350M/2-L120 2 Pieces Set/△=230g
PLASTIC BAG

Sockets	
<ul style="list-style-type: none"> 3/8" 3350M(L120) Nut Grip Extra Deep Sockets 10, 12 	

Nut Grip Extra Deep Socket

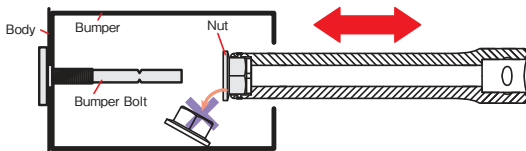

3350M/2-L120 Socket Set
Steckschlüssel Satz
Jeu de clés à douille



Z-SERIES
 HAND
 TITANIUM
 ACCESSORIES
 SCREWDRIVERS
 IMPACT
 SLEEVE-DRIVE
 PROTECTOR
 INDUSTRIAL
 AUTOMOTIVE
 MOTORCYCLE
 CONSTRUCTION
 SPARE PART

1212  Long shank Screwdriver 4 pieces set
 Extra lange Schraubendreher 4teiliger Satz
 Tournevis longs. Jeu de 4 pièces

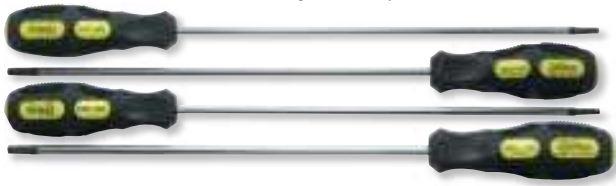

168T (250)  Extra long shank Screwdrivers
 Extra lange Schraubendreher
 Tournevis extra longs

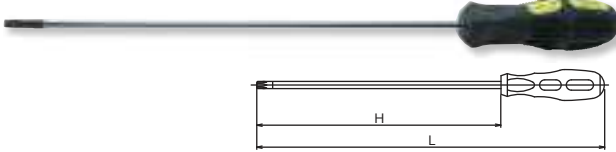

169/2 Door Trim Pad Tool, 2 pieces set
 Demontagehebel für Türclips, Satz 2-teilig
 Jeu, levier pour le démontage des garnitures de portes

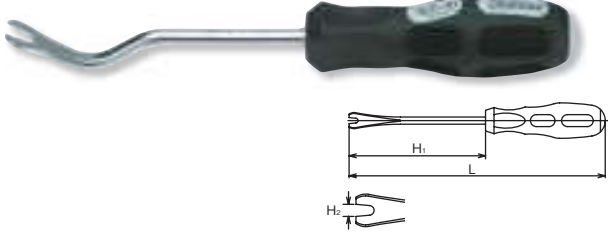

169WM Window Molding Remover
 Zum Lösen von Fenstergummis
 Pour le démontage des joints de vitres



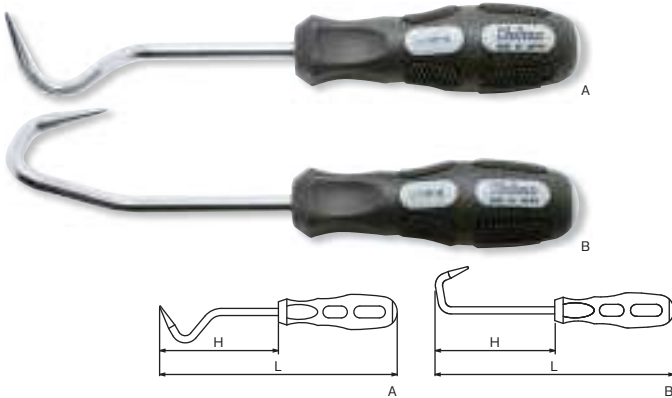

169HR/2 Hose Remover, 2 pieces set
 Universalhaken, 2teiliger Satz
 Pour le démontage des tuyaux. Jeu de 2 pièces



169BP For Battery Screws
 Für Batterie-Verschlussstopfen
 Pour vis de batterie



1212 4 Pieces Set/📦=380g
 PLASTIC BAG

Screwdrivers	
	168T(250) 20IPR
	168T(250) T20, T25, T30



Long shank Screw Screwdriver

168T(250) (IPR)	H (mm)	L (mm)	(g)	(pce.)
20IPR	250	350	85	1

168T(250) (T)	H (mm)	L (mm)	(g)	(pce.)
T20	250	350	85	1
T25	250	350	85	1
T30	250	360	120	1

169/2 2 Pieces Set/📦=200g
 PLASTIC BAG

Clip Handles	
169	
6, 10	

169	H ₁ (mm)	H ₂ (mm)	L (mm)	(g)	(pcs.)
6	115	5	215	80	2
10	120	9	230	110	2



Clip Handle

169WM	H (mm)	L (mm)	(g)	(pcs.)
169WM	100	210	90	2

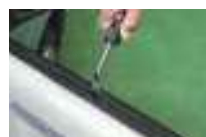

Window Molding Remover

169HR/2 2 Pieces Set/📦=180g
 PLASTIC BAG

Hose Remover	
169HR	
A, B	

169HR	H (mm)	L (mm)	(g)	(pcs.)
A	100	200	75	2
B	100	200	90	2



Hose Remover

169BP	T×W (mm)	H (mm)	L (mm)	(g)	(pcs.)
1.8×13	1.8×13	50	150	60	2



For Battery screw



Quick Fastener

4425 (E)		D ₁ (mm)	D ₂ (mm)	H (mm)	L (mm)	(g)	(pcs.)
E10N		13.2	21	8.2	36	47	10
E12N		14.6	21	9.3	37	48	10
E14N		16.5	21	10.6	37	50	10
E16N		19	22	11.8	37	60	10
E18N		20.3	22	13	37	60	10
E20N		22.8	22	14.4	37	65	10

RS4425/6-N	6 Pieces Set/Rail 200mm	(g)
E10N, E12N, E14N, E16N, E18N, E20N		370



Engine type : QR/MR
Flywheel bolt for NISSAN E20N

13145A.150 (inch)		D ₁ (mm)	D ₂ (mm)	H (mm)	L (mm)	(g)	(pcs.)	
9/16(D20)		20	19	13	150	130	5	*1

*1 C-Ring=C31, Pin/O-Ring=A31/B31 → P256-257

14145A.150 (inch)		D ₁ (mm)	D ₂ (mm)	H (mm)	L (mm)	(g)	(pcs.)	
9/16(D20)		20	25	13	150	200	5	*1

*1 C-Ring=C41, Pin/O-Ring=A41/B41
For Land Rover Prop Shaft

		D ₁ (mm)	D ₂ (mm)	L (mm)	(g)	(pcs.)	
13772-B		22	19	75	120	5	*1
13772-P		22	19	75	120	5	*1
14772-B		27	25	90	230	1	*2
14772-P		27	25	90	230	1	*2

*1 C-Ring=C31, Pin/O-Ring=A31/B31
*2 C-Ring=C41, Pin/O-Ring=A41/B41 → P256-257



13772 and 14772 have less load capacity than standard. In the interest of your safety always use properly.

14305M (mm)		D ₁ (mm)	D ₂ (mm)	H ₁ (mm)	H ₂ (mm)	L (mm)	(g)	(pcs.)	
30		42	30	30	63	85	457	10	*2
32		44.5	30	32	63	85	542	10	*2
36		49.5	30	36	61	85	635	2	*2

*2 C-Ring=C42, Pin/O-Ring=A42/B42 → P256-257



4101		T×W (mm)	D (mm)	L (mm)	(g)	(pcs.)
1		2.7×18.6	22	40	59	10
2		3.7×24	24	40	79	10
3		3.7×30	30	40	128	10

6101		T×W (mm)	D (mm)	L (mm)	(g)	(pcs.)
6101		6.4×33.5	35	50	205	5

TORX is a registered trademark of CAMCAR Innovations.
TORX ist ein registriertes Markenzeichen der Firma CAMCAR Innovations.
TORX est une marque déposée de CAMCAR Innovations.

4425-N

TORX® Sockets
TORX® Steckschlüssel
Douilles TORX®

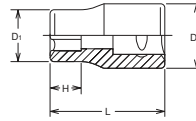

RS4425/6-N

Socket Set on Rail
Steckschlüsselsatz auf Schiene
Jeu de douilles sur rail



13145A-150

Extra Long Socket
Schaftsteckschlüssel
Douilles, série allongée

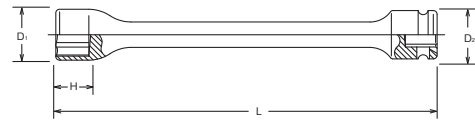

13772

Universal Double Joint
Doppelgelenk-Einsatz
Joint articulé double

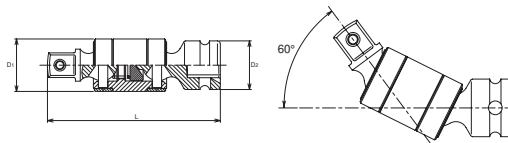

14305M

12-point Deep Sockets
12-kant Steckschlüssel, lang
Douilles longues 12-pans

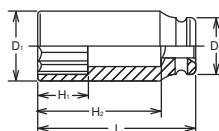

4101

Sockets for Slotted Heads
Steckschlüssel für Schlitzschrauben
Douilles tournevis pour vis à fente

6101

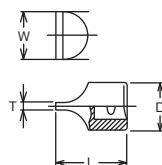

Z-SERIES
 HAND
 TITANIUM
 SCREWDRIVERS ACCESSORIES
 IMPACT
 SLEEVE-DRIVE
 PROTECTOR
 INDUSTRIAL
 AUTOMOTIVE
 MOTORCYCLE
 CONSTRUCTION
 SPARE PART

4300M (L60)



Wheel Nut Sockets
 Radmuttern Steckschlüssel
 Douilles pour écrous de roue

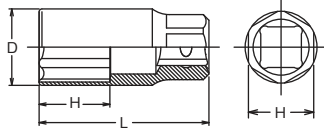

4300M(L60) (mm)		D (mm)	H (mm)	L (mm)	H (mm)	 (g)	 (pcs.)
17	1/2"	23.8	25	60	21	98	10
19		25.8	25	60	21	100	10
21		27.6	25	60	21	102	10



Wheel Nut Sockets

Please note that thin walled design is only for wheel nut work and Torque rating is limited.

4300M (L110)



Wheel Nut Sockets (Long)
 Radmuttern-Steckschlüssel, extra lang
 Douilles extra longues pour écrous de roue

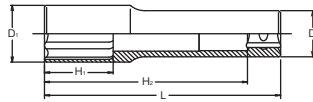

4300M(L110) (mm)		D ₁ (mm)	D ₂ (mm)	H ₁ (mm)	H ₂ (mm)	L (mm)	 (g)	 (pcs.)
17	1/2"	23.8	22	32	93	110	155	5
19		25.8	22	32	93	110	170	5
21		27.6	22	32	93	110	165	5

Please note that thin walled design is only for wheel nut work and Torque rating is limited.

4711X



Spinning cross wrench
 T-Griff für die Radmuttermontage
 Poignée coulissante pour montage des écrous à roue

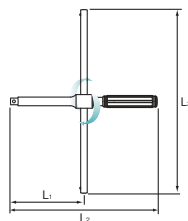

		L ₁ (mm)	L ₂ (mm)	L ₃ (mm)	 (g)	 (pce.)
4711X	1/2"	140	280	350	945	1

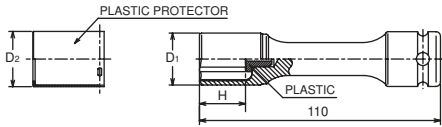

14201M 14145PM-110

- Wheel Nut Sockets Set
- Radmutter Steckschlüssel im Satz
- Douilles pour écrous de roue
- Wheel Nut Sockets
- Radmutter Steckschlüssel
- Douilles pour écrous de roue



14201M 3 Pieces Set/ =690g
CARDBOARD BOX:W125xH95xT34mm

Sockets
14145PM.110 Impact Wheel Nut Sockets
17, 19, 21

14145PM-110 (mm)		D ₁ (mm)	D ₂ (mm)	H (mm)	Shaft Colour	(g)	(pcs.)	
17		23.8	25.2	21	Blue	208	5	*1
19	1/2"	25.8	27.2	23	Red	219	5	*1
21		27.6	29	25	Yellow	226	5	*1
22		29	30.5	26	White	238	5	*1

*1 C-Ring=C41, Pin/O-Ring=A41/B41 → P256-257



PLASTIC PROTECTOR KUNSTSTOFF HÜLSE PROTECTION EN PLASTIQUE

A detachable plastic protector is fitted to the socket to prevent damage to the wheel when working in tight areas. The socket size and Ko-ken mark printed on the shaft makes it easier to see if the socket is still rotating or stopped.

Zum Schutz empfindlicher Leichtmetallfelgen ist eine drehbare und abnehmbare Kunststoff Hülse an dem Steckschlüssel montiert. Die aufgedruckten Markierungen am Werkzeugschaft zeigen außerdem ob das Werkzeug steht oder rotiert.

La douille est pourvue d'un insert en plastique détachable. Il sert à prévenir tout dommage aux jantes lors de l'utilisation des douilles.

Le marquage sur la tige rend l'identification des douilles très facile.

198-17	: Spare Plastic Protector for 14145PM.110-17	: 10 pcs.
198-19	: Spare Plastic Protector for 14145PM.110-19	: 10 pcs.
	280PM-19	
198-21	: Spare Plastic Protector for 14145PM.110-21	: 10 pcs.
	280PM-21	
198-22	: Spare Plastic Protector for 14145PM.110-22	: 10 pcs.

14145M-110 (mm)		D ₁ (mm)	D ₂ (mm)	H (mm)	(g)	(pcs.)
New 17MB	1/2"	25.7	27.2	11.5	256	5



Mercedes Benz Wheel Bolt

280PM (mm)	D ₁ (mm)	D ₂ (mm)	H ₁ (mm)	L (mm)	H ₂ (mm)	Shaft Colour	(g)	(pcs.)
19	25.8	27.2	13	52	19	Red	150	5
21	27.6	29	13	55	21	Yellow	180	5



14145M-110MB Wheel Bolt Socket

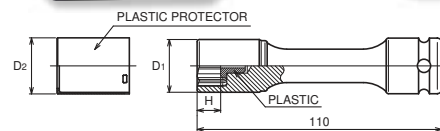

280PM Adaptor Socket for Low Profile Wheel Nut

- Adaptor Steckschlüssel für kurze Radmutter
- Adapteur pour des écrous de roue courts

Designed for Low Profile Wheel nut socket.

Detachable plastic protector is fitted to the adaptor to prevent damage to painted or surface treatment area on the wheel. The Plastic insert locate inside of the adaptor prevents damage to wheel nut. Colour coded band make size identification easy.

Die abnehmbare Kunststoffhülse schützt die Felge vor Kratzern oder Schrammen an der empfindlichen Oberfläche. Der Kunststoffanschlag im inneren des Werkzeugs schützt zusätzlich die Radmutter. Die Farbmarkierung macht die Identifikation des Werkzeugs einfach.

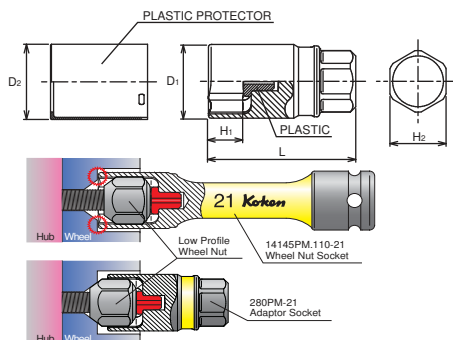

La protection plastifiée amovible, protège la jante et évite des endommagements sur des surfaces délicates. Le plastic inséré à l'intérieur de l'outil protège également l'écrou de roue. L'identification de l'outil est simplifiée par le marquage en couleur.



Z-SERIES
 HAND
 TITANIUM
 SCREWDRIVERS ACCESSORIES
 IMPACT
 SLEEVE-DRIVE
 PROTECTOR
 INDUSTRIAL
 AUTOMOTIVE
 MOTORCYCLE
 CONSTRUCTION
 SPARE PART

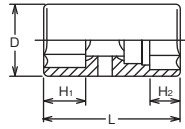



14118M  Wheel Nut Sockets, Double Ended
 Radmuttern Steckschlüssel, doppelseitig
 Douilles pour écrous de roue à ouvertures doubles



14118M (mm)		D (mm)	H ₁ (mm)	H ₂ (mm)	L (mm)	 (g)	 (pcs.)
17×19		28	15.5	13	48	150	10
19×21		31	17.5	13	57	177	10
19×22		31	17.5	15	57	187	10

14218M  Wheel Nut Sockets, Double Ended with Extension Bar
 Radmuttern Steckschlüssel, doppelseitig, mit Verlängerung
 Douille pour écrous de roue à ouvertures double plus rallonge





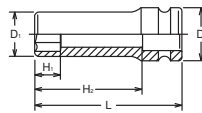

14218M		2 Pieces Set/  =360g	
CARDBOARD BOX			
Sockets		Accessory	
		14118PM 19×21	 14760ST-B

Interchangeable Wheel Nut Socket of 19mm and 21mm.

AN14300  Impact Sockets, Aluminium alloyed, for aluminium wheel nuts
 Aluminium-legierte Impact Steckschlüssel für Aluminium Radmuttern
 Douilles Impact en aluminium pour écrous de roue aluminium





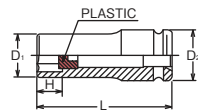

AN14300 (mm)		D ₁ (mm)	D ₂ (mm)	H ₁ (mm)	H ₂ (mm)	L (mm)	 (g)	 (pcs.)	
17		25.7	30	17	62	80	85	10	*1
19		28.2	30	19	61	80	89	10	*1
21		30.7	30	21	61	80	93	10	*1

*1 C-Ring=C42, Pin/O-Ring=A42/B42 → P256-257

14113J  Impact Sockets with Plastic Stops for Hub Cap Screws
 Impact Steckschlüssel mit Plastik-Anschlag für Zier-Radmuttern
 Douilles Impact avec arrêt en plastique, pour écrous de roue décoratifs





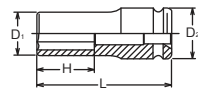

14113J (mm)		D ₁ (mm)	D ₂ (mm)	H (mm)	L (mm)	 (g)	 (pcs.)	
17		25.7	30	14	80	251	10	*1
19		28.2	30	16	80	286	10	*1
21		30.7	30	20	80	309	10	*1

*1 C-Ring=C42, Pin/O-Ring=A42/B42 → P256-257

14113M  For Hub Cap Screws
 Für Zier-Radmuttern
 Pour écrous de roue décoratifs



14113M (mm)		D ₁ (mm)	D ₂ (mm)	H (mm)	L (mm)	 (g)	 (pcs.)	
17		25.7	30	34	80	230	10	*1
19		28.2	30	38	80	262	10	*1
21		30.7	30	42	80	285	10	*1

*1 C-Ring=C42, Pin/O-Ring=A42/B42 → P256-257

Z-SERIES
HAND
TITANIUM
ACCESSORIES
SCREWDRIVERS
IMPACT
SLEEVE-DRIVE
PROTECTOR
INDUSTRIAL
AUTOMOTIVE
MOTORCYCLE
CONSTRUCTION
SPARE PART

14124 (mm)		D ₁ (mm)	D ₂ (mm)	H ₁ (mm)	H ₂ (mm)	L (mm)	 (g)	 (pcs.)
21×24.5	1/2"	28	29.5	24	25	65	157	10
26×27.5		31.5	35	24.5	24.5	65	197	10

14124 Lock Nut Busters (Double Ended)
Felgenschloss-Knacker, doppelseitig
Douilles taraudées à ouvertures doubles pour
dévisser les écrous ou goujons de roue antivols.

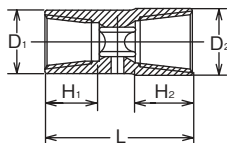

14124/3		3 Pieces Set/=580g
CARDBOARD BOX:W125×H91×T43mm		
Sockets		Accessory
	14124 21×24.5 26×27.5	14760-75B



14124/3 Lock Nut Busters (Double Ended) in Set
Felgenschloss-Knacker, doppelseitig im Satz
Jeu de douilles taraudées à ouvertures doubles pour
dévisser les écrous ou goujons de roue antivols.



14124 (mm)		D ₁ (mm)	D ₂ (mm)	H (mm)	L (mm)	 (g)	 (pcs.)	
17	1/2"	20.5	25	15	50	83	10	*1
18		21	25	15	50	83	10	*1
18.5		23	25	15	50	95	10	*1
19		25	30	20.5	50	140	10	*2
21		28	30	20.5	50	153	10	*2
24.5		29.5	30	23	50	138	10	*2
26		31.5	30	23	50	147	10	*2
27.5		35	30	23	50	181	10	*2

*1 C-Ring=C41, Pin/O-Ring=A41/B41
*2 C-Ring=C42, Pin/O-Ring=A42/B42 P256-257

14124 Lock Nut Busters
Felgenschloss-Knacker
Douilles taraudées pour dévisser les
écrous ou goujons de roue antivols.

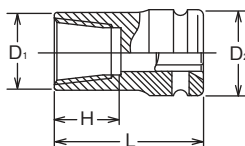



RS14124/7	7 Pieces Set/Rail 250mm	 (g)
18, 18.5, 19, 21, 24.5, 26, 27.5		980

RS14124/7 Socket Set on Rail
Steckschlüsselsatz auf Schiene
Jeu de douilles sur rail



Z-SERIES
 HAND
 TITANIUM
 ACCESSORIES
 SCREWDRIVERS
 IMPACT
 SLEEVE-DRIVE
 PROTECTOR
 INDUSTRIAL
 AUTOMOTIVE
 MOTORCYCLE
 CONSTRUCTION
 SPARE PART



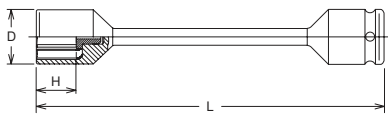
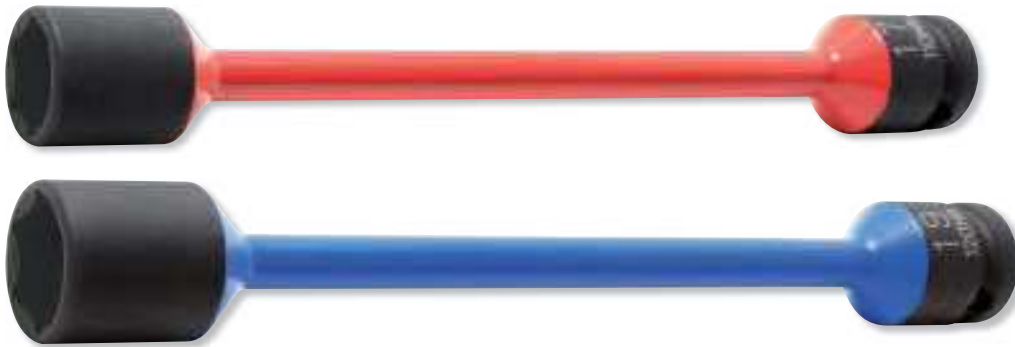





















14101MP  Torsion Bars (for tightening only)
 Torsionsstäbe (nur zum Anziehen)
 Barres de torsion (pour serrage seulement) 



 As the torque could vary with the type and the condition of the impact wrench, we strongly recommend the control with a torque wrench.

Da die Drehmomentwerte von Art und Leistung des verwendeten Schlagschraubers abhängen, empfehlen wir die Kontrolle der Kombination Schlagschrauber/Torsionsstab mittels eines Drehmomentschlüssels.

Etant donné que le couple peut varier selon modèle, la capacité ou l'état de la clé à choc, le contrôle de la combinaison clé à choc/barre par clé dynamométrique est indispensable.

14101MP (mm×Nm)		D (mm)	H (mm)	L (mm)	Shaft Colour		
 17× 95Nm		24	16	214		10	*1
 17×110Nm		24	16	204		10	*1
 17×120Nm		24	16	203		10	*1
 19× 90Nm		26	18	259		10	*1
 19×100Nm		26	18	233		10	*1
 19×120Nm		26	18	204		10	*1
 19×140Nm		26	18	199		10	*1
 21×100Nm		28	22	216		10	*1
 21×120Nm		28	22	205		10	*1
 22×150Nm		29	22	220		10	*1

*1 C-Ring=C41, Pin/O-Ring=A41/B41 → P256-257

14101MP-M/8  Metal-Wall-Hanger for Workshops
 Werkstatt-Wandhänger (Metall)
 Support métallique d'atelier 





14101MP-M/8 8 Pieces Set/△=2,300g
HANGER
 Torsion Bar
 **14101MP Impact Torsion Bars**
 17×95Nm, 17×110Nm, 17×120Nm,
 19×90Nm, 19×100Nm, 19×120Nm, 19×140Nm, 21×100Nm



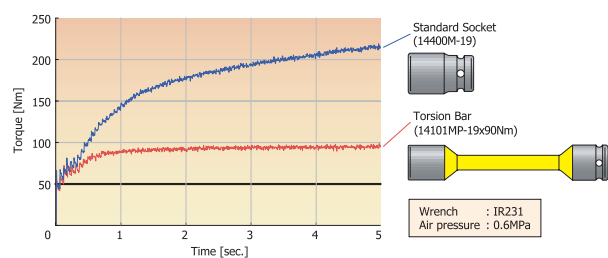

Torque table included in delivery.
 Drehmomenttabelle wird mitgeliefert.
 Tableau des couples de serrage inclus dans la livraison.

- Torsion Bars**
- Designed for tightening wheel nuts with an impact wrench.
 - Prevent the excessive torque road.
 - Colour coded shafts make size identification easy.
- Torsionsstäbe**
- Zur Montage von Radmuttern mit dem Schlagschrauber.
 - Schützt die Radmutter vor zu hohen Anzugsmomenten.
 - Die Farbmarkierung erleichtert das Erkennen des passenden Werkzeugs.
- Barres de torsion**
- Pour le montage d'écrou de roue avec visseuse à chocs.
 - Protège l'écrou d'un serrage à couple excessif.
 - La colorisation des barres facilite l'identification des tailles.

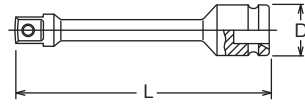



14112-P  Torsion Extension Bars (for tightening only)
Torsionsstab-Verlängerungen (nur zum Anziehen) 
Barres de torsion (pour serrage seulement)







14112-P (Nm)		D (mm)	L (mm)	 (g)	 (pce.)	
90Nm		25	208	206	1	*1
95Nm		25	202	200	1	*1
100Nm		25	196	198	1	*1
110Nm		25	213	220	1	*1
120Nm		25	201	219	1	*1
130Nm		25	205	225	1	*1
140Nm		25	205	230	1	*1
150Nm		25	195	250	1	*1
170Nm	25	195	257	1	*1	

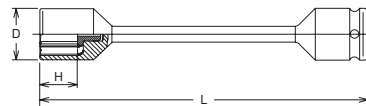

*1 C-Ring=C41, Pin/O-Ring=A41/B41 → P256-257

14101M  Torsion Bars (for tightening only)
Torsionsstäbe (nur zum Anziehen) 
Barres de torsion (pour serrage seulement)





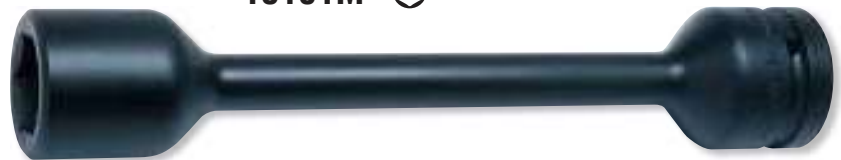
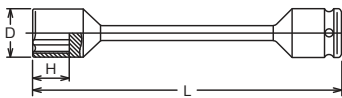

14101M (mm×Nm)		D (mm)	H (mm)	L (mm)	 (g)	 (pce.)	
17× 60Nm		24	16	216	227	1	*1
17× 75Nm		24	16	228	240	1	*1
17× 95Nm		24	16	214	256	1	*1
17×110Nm		24	16	204	285	1	*1
17×120Nm		24	16	203	284	1	*1
19× 60Nm		26	18	219	237	1	*1
19× 90Nm		26	18	259	275	1	*1
19×110Nm		26	18	214	278	1	*1
19×120Nm		26	18	204	297	1	*1
19×135Nm		26	18	204	339	1	*1
19×170Nm		26	18	193	332	1	*1
21×100Nm		28	22	216	288	1	*1
21×120Nm		28	22	205	288	1	*1
22×160Nm		29	22	210	385	1	*1

*1 C-Ring=C41, Pin/O-Ring=A41/B41 → P256-257

16101M 
18101M  Torsion Bars (for tightening only)
Torsionsstäbe (nur zum Anziehen) 
Barres de torsion (pour serrage seulement)







16101M (mm×Nm)		D (mm)	H (mm)	L (mm)	 (g)	 (pce.)	
24×180Nm		38.8	24	235	850	1	*1
27×450Nm		42.5	27	280	1236	1	*1
32×600Nm		48.8	32	280	1370	1	*1
33×600Nm		50	33	280	1370	1	*1

*1 C-Ring=C61, Pin/O-Ring=A61/B61 → P256-257

 As the torque could vary with the type and the condition of the impact wrench, we strongly recommend the control with a torque wrench.

Da die Drehmomentwerte von Art und Leistung des verwendeten Schlagschraubers abhängen, empfehlen wir die Kontrolle der Kombination Schlagschrauber/Torsionsstab mittels eines Drehmomentschlüssels.

Etant donné que le couple peut varier selon modèle, la capacité ou l'état de la clé à choc, le contrôle de la combinaison clé à choc/barre par clé dynamométrique est indispensable.

18101M (mm×Nm)		D (mm)	H (mm)	L (mm)	 (g)	 (pce.)	
24×350Nm		43.5	24	300	1380	1	*1
27×350Nm		47	27	300	1401	1	*1
27×450Nm		47	27	300	1579	1	*1
30×500Nm		51	30	300	1563	1	*1
32×450Nm		53.5	32	300	1600	1	*1
32×550Nm		53.5	32	300	1602	1	*1
32×600Nm		53.5	32	300	1602	1	*1
32×700Nm		51.5	32	300	1630	1	*1
33×550Nm		55	33	300	1638	1	*1
33×600Nm		55	33	300	1638	1	*1
36×600Nm		58.5	36	300	1718	1	*1

*1 C-Ring=C81, Pin/O-Ring=A81/B81 → P256-257

Z-SERIES
 HAND
 TITANIUM
 SCREWDRIVERS ACCESSORIES
 IMPACT
 SLEEVE-DRIVE
 PROTECTOR
 INDUSTRIAL
 AUTOMOTIVE
 MOTORCYCLE
 CONSTRUCTION
 SPARE PART

6102M-400
8102M-400

Extra long socket for wheel nuts
 Extra lange Steckschlüssel für Radmuttern
 Douilles extra-longues pour écrous de roue

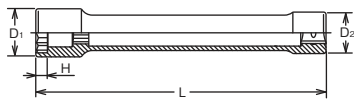

6102M-400 (mm)		D ₁ (mm)	D ₂ (mm)	H (mm)	L (mm)	(g)	(pce.)
41Wx21W	3/4"	58	40	14	400	1880	1
32		48.5	40	32	400	1480	1
33		49.8	40	32	400	1500	1

8102M-400 (mm)		D ₁ (mm)	D ₂ (mm)	H (mm)	L (mm)	(g)	(pce.)
41Wx21W	1"	58	49.9	14	400	2610	1
32		48.5	49.9	32	400	2210	1
33		49.8	49.9	32	400	2220	1

⚠ 6102M/8102M are for hand use only. Do not use with a power tools.



Extra long Socket for wheel nut



Combination type
41Wx21W

16102M-270 / -400
18102M-270 / -400

Extra long Sockets for wheel Nuts
 Extra lange Steckschlüssel für Radmuttern
 Douilles extra-longues pour écrous de roue

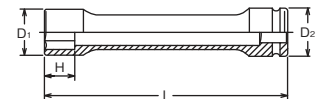

16102M-270 (mm)		D ₁ (mm)	D ₂ (mm)	H (mm)	L (mm)	(g)	(pce.)	
24	3/4"	38.8	44	24	270	1034	1	*1
27		42.5	44	27	270	1088	1	*1
30		46.3	44	30	270	1144	1	*1
32		48.8	44	32	270	1157	1	*1
33		50	44	32	270	1200	1	*1
36		53.8	44	32	270	1250	1	*1
38		56.3	44	32	270	1610	1	*1
41		60	44	32	270	1640	1	*1

*1 C-Ring=C61, Pin/O-Ring=A61/B61 → P256-257

16102M-400 (mm)		D ₁ (mm)	D ₂ (mm)	H (mm)	L (mm)	(g)	(pce.)	
24	3/4"	38.8	44	24	400	1430	1	*1
27		42.5	44	27	400	1460	1	*1
30		46.3	44	30	400	1510	1	*1
32		48.8	44	32	400	1530	1	*1
33		50	44	32	400	1530	1	*1
36		53.8	44	32	400	2180	1	*1

*1 C-Ring=C61, Pin/O-Ring=A61/B61 → P256-257

18102M-270 (mm)		D ₁ (mm)	D ₂ (mm)	H (mm)	L (mm)	(g)	(pce.)	
23	1"	37.3	54	23	270	1627	1	*1
24		38.5	54	24	270	1628	1	*1
26		41	54	26	270	1667	1	*1
27		42.3	54	27	270	1680	1	*1
29		44.8	54	29	270	1680	1	*1
30		46	54	30	270	1680	1	*1
32		48.5	54	32	270	1680	1	*1
33		49.8	54	32	270	1700	1	*1
34		51	54	32	270	1750	1	*1
36		53.5	54	32	270	1750	1	*1
38		56	54	32	270	1822	1	*1
41		60	54	32	270	1800	1	*1

*1 C-Ring=C81, Pin/O-Ring=A81/B81 → P256-257

18102M-400 (mm)		D ₁ (mm)	D ₂ (mm)	H (mm)	L (mm)	(g)	(pce.)	
23	1"	37.3	54	23	400	1865	1	*1
24		38.5	54	24	400	1869	1	*1
26		41	54	26	400	1925	1	*1
27		42.3	54	27	400	2272	1	*1
29		44.8	54	29	400	2278	1	*1
30		46	54	30	400	2266	1	*1
32		48.5	54	32	400	2322	1	*1
33		49.8	54	32	400	2320	1	*1
34		51	54	32	400	2341	1	*1
36		53.5	54	32	400	2442	1	*1
38		56	54	32	400	2550	1	*1

*1 C-Ring=C81, Pin/O-Ring=A81/B81 → P256-257

PW6P (mm×mm)	D ₁ (mm)	D ₂ (mm)	H (mm)	L (mm)	Shaft Color	(g)	(pcs.)	Ⓢ
New 32×17	47	44	12	75	Orange	621	2	*1
New 35×17	50	44	12	75	White	655	2	*1
New 38×20	55	44	12	75	Red	705	2	*1
New 41×19	58	44	12.5	80	Green	813	2	*1
New 41×20	58	44	12.5	80	Blue	813	2	*1
New 41×21	58	44	12.5	80	Yellow	779	2	*1

*1 C-Ring=C61, Pin/O-Ring=A61/B61 → P256-257

PW8P (mm×mm)	D ₁ (mm)	D ₂ (mm)	H (mm)	L (mm)	Shaft Color	(g)	(pcs.)	Ⓢ
New 35×17	50	54	12	83	White	867	2	*1
New 38×20	55	54	12	83	Red	941	2	*1
New 41×19	58	54	12.5	87	Green	1033	2	*1
New 41×20	58	54	12.5	87	Blue	1033	2	*1
New 41×21	58	54	12.5	87	Yellow	997	2	*1

*1 C-Ring=C81, Pin/O-Ring=A81/B81 → P256-257

**PW6P
PW8P**  Rear Wheel Nut Sockets
Steckschlüssel für Hinterradmuttern
Douilles spéciales pour écrous de roué arrière

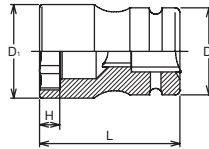

Tightening / Loosening Outer Nut

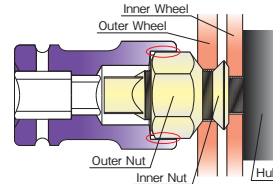

Tightening / Loosening Inner Nut

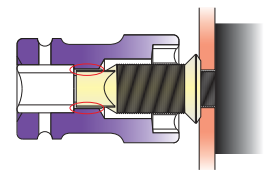

PW8P/4 4 Pieces Set/⚖️=4,250g

CARDBOARD BOX:W240×H95×T70mm

Sockets

 **PW8P** Impact Rear Wheel Nut Sockets
35×17, 38×20, 41×19, 41×21

PW8P (mm×mm)	□	D ₁ (mm)	D ₂ (mm)	H (mm)	L (mm)	(g)	Shaft Colour	(pcs.)	Ⓢ
35×17		50	54	13	83	935	White	5	*1
38×20	1"	55	54	14	83	1038	Red	5	*1
41×19		58	54	14	87	1100	Green	5	*1
41×21		58	54	14	87	1089	Yellow	5	*1

*1 C-Ring=C81, Pin/O-Ring=A81/B81 → P256-257

**PW8P/4
PW8P**  Socket set of Rear Wheel Nut Sockets
Steckschlüssel für Hinterradmuttern, im Satz
Jeu de douilles spéciales pour écrous de roué arrière



PW8L (mm×mm)	□	D ₁ (mm)	D ₂ (mm)	H (mm)	L (mm)	(g)	(pcs.)	Ⓢ
41×21	1"	58	54	15	105	1263	1	*1

*1 C-Ring=C81, Pin/O-Ring=A81/B81 → P256-257

PW8L  Rear Wheel Nut Socket (long)
Steckschlüssel für Hinterradmuttern, lang
Douilles spéciales pour écrous de roué arrière longue

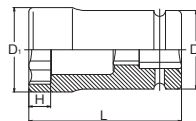

PS6 (mm)	□	D ₁ (mm)	D ₂ (mm)	H (mm)	L (mm)	(g)	(pcs.)	Ⓢ
17		40	44	19	53	433	5	*1
19	3/4"	40	44	19	53	419	5	*1
20		44	44	21	55	483	5	*1
21		44	44	23	60	491	5	*1

*1 C-Ring=C61, Pin/O-Ring=A61/B61 → P256-257

**PS6
PS8**  Rear Wheel Nut Sockets
Steckschlüssel für Hinterradmuttern
Douilles spéciales pour écrous de roué arrière

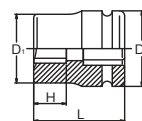

PS8 (mm)	□	D ₁ (mm)	D ₂ (mm)	H (mm)	L (mm)	(g)	(pcs.)	Ⓢ
17		40	54	19	60	621	2	*1
19	1"	43	54	19	60	648	2	*1
20		45	54	21	62	687	2	*1
21		45	54	23	64	696	2	*1

*1 C-Ring=C81, Pin/O-Ring=A81/B81 → P256-257

Z-SERIES
 HAND
 TITANIUM
 SCREWDRIVERS ACCESSORIES
 IMPACT
 SLEEVE-DRIVE
 PROTECTOR
 INDUSTRIAL
 AUTOMOTIVE
 MOTORCYCLE
 CONSTRUCTION
 SPARE PART

14466A-200B 14488A-B / -200B

Adaptor
 Verbindungsstück
 Réducteur

No Warranty
 Keine Garantie
 Sans Garantie

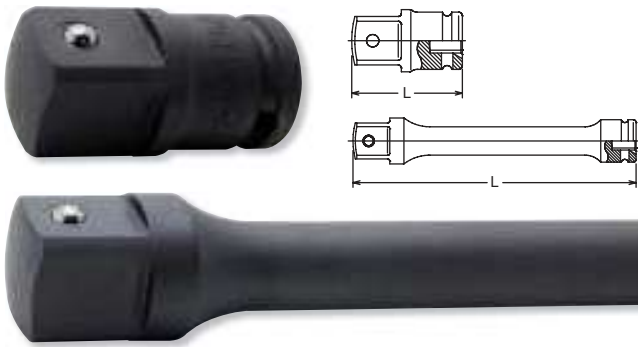
	□ (sq)	□ (sq)	L (mm)	⚖ (g)	📦 (pce.)	⚡
14466A-200B	1/2"	3/4"	200	560	1	*2
14488A-B	1/2"	1"	58	280	1	*2
14488A-200B	1/2"	1"	200	660	1	*2

*2 C-Ring=C42, Pin/O-Ring=A42/B42 → P256-257

(PW8P-41X21 + 14488A-200B + 1/2" SQ. Impact wrench)



14466A-B / 14488A-B Impact Adaptors (□1/2" SQ. → □3/4", 1" SQ.)

For temporary fastening a wheel nut socket for large vehicle with a light duty 1/2" SQ. DR. Impact wrench.

 Socket is not completely locked with the Ball-type adaptor connection. Please beware of accidental socket release.

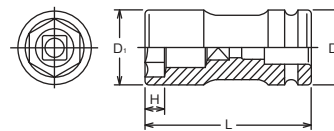

16316M / 16316A 18316M / 18316A

Rear Wheel Nut Sockets
 Steckschlüssel für Hinterradmuttern
 Douilles spéciales pour écrous de roué arrière



16316M (mm×mm)	□	D ₁ (mm)	D ₂ (mm)	H (mm)	L (mm)	⚖ (g)	📦 (pce.)	⚡
35×17	3/4"	52	44	10	90	865	1	*1
38×20		56	44	13	100	952	1	*1
41×19		59	44	12	100	1037	1	*1
41×21		59	44	15	100	963	1	*1

*1 C-Ring=C61, Pin/O-Ring=A61/B61 → P256-257

18316M (mm×mm)	□	D ₁ (mm)	D ₂ (mm)	H (mm)	L (mm)	⚖ (g)	📦 (pce.)	⚡
35×17	1"	52	54	10	108	1153	1	*1
38×20		56	54	13	108	1133	1	*1
41×19		59	54	12	108	1200	1	*1
41×21		59	54	15	108	1155	1	*1

*1 C-Ring=C81, Pin/O-Ring=A81/B81 → P256-257

16316A (inch×inch)	□	D ₁ (mm)	D ₂ (mm)	H (mm)	L (mm)	⚖ (g)	📦 (pce.)	⚡
1.1/2×13/16	3/4"	56	44	13	100	940	1	*1

*1 C-Ring=C61, Pin/O-Ring=A61/B61 → P256-257

18316A (inch×inch)	□	D ₁ (mm)	D ₂ (mm)	H (mm)	L (mm)	⚖ (g)	📦 (pce.)	⚡
1.1/2×13/16	1"	59	54	13	108	1120	1	*1

*1 C-Ring=C81, Pin/O-Ring=A81/B81 → P256-257

16317M / 16317A 18317M / 18317A

Rear Wheel Nut Sockets
 Steckschlüssel für Hinterradmuttern
 Douilles spéciales pour écrous de roué arrière

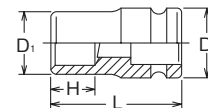

16317M (mm)	□	D ₁ (mm)	D ₂ (mm)	H (mm)	L (mm)	⚖ (g)	📦 (pce.)	⚡
17	3/4"	40	44	22.5	67	485	1	*1
19		40	44	22.5	67	462	1	*1
20		44	44	22.5	67	517	1	*1
21		44	44	22.5	67	489	1	*1
22		44	44	22.5	67	482	1	*1

*1 C-Ring=C61, Pin/O-Ring=A61/B61 → P256-257

18317M (mm)	□	D ₁ (mm)	D ₂ (mm)	H (mm)	L (mm)	⚖ (g)	📦 (pce.)	⚡
17	1"	40	54	22.5	72	682	1	*1
17.5		40	54	22.5	72	677	1	*1
19		43	54	22.5	72	705	1	*1
20		45	54	22.5	72	723	1	*1
20.5		45	54	22.5	72	723	1	*1
21		45	54	22.5	72	703	1	*1
22		45	54	22.5	72	696	1	*1

*1 C-Ring=C81, Pin/O-Ring=A81/B81 → P256-257

16317A (inch)	□	D ₁ (mm)	D ₂ (mm)	H (mm)	L (mm)	⚖ (g)	📦 (pce.)	⚡
13/16	3/4"	44	44	22.5	67	489	1	*1

*1 C-Ring=C61, Pin/O-Ring=A61/B61 → P256-257

18317A (inch)	□	D ₁ (mm)	D ₂ (mm)	H (mm)	L (mm)	⚖ (g)	📦 (pce.)	⚡
13/16	1"	45	54	22.5	72	703	1	*1

*1 C-Ring=C81, Pin/O-Ring=A81/B81 → P256-257







MOTORCYCLE TOOLS
MOTORRAD WERKZEUGE
OUTILLAGE MOTO

Z-SERIES
 HAND
 TITANIUM
 ACCESSORIES
 SCREWDRIVERS
 IMPACT
 SLEEVE-DRIVE
 PROTECTOR
 INDUSTRIAL
 AUTOMOTIVE
 MOTORCYCLE
 CONSTRUCTION
 SPARE PART

4400M (DU)  6 point Socket, extra short for Motorcycle central chain-wheel screws
 6 kant Steckschlüssel, extra kurz für Motorrad Kettenrad-Zentralmuttern
 Douille 6-pans, extra-court, pour moto, pour roue d'entraînement écrou-central







4400M		D ₁ (mm)	D ₂ (mm)	H (mm)	L (mm)	 (g)	 (pcs.)
41DU		53	45	15	28	239	5
46DU		59	48	15	28	279	5



4405M (DU)  12 point Socket, extra short for motorcycle rear-axle screws
 12 kant Steckschlüssel, extra kurz, für Motorrad-Hinterradmuttern
 Douille 12-pans, extra-court, pour moto, pour écrou roue-arrière







4405M		D ₁ (mm)	D ₂ (mm)	H (mm)	L (mm)	 (g)	 (pcs.)
36DU		47.3	41	15	28	200	5
55DU		71	52	16	31	410	5



6405A (MV)  12 point Socket, extra short for motorcycle rear-axle screws
 12 kant Steckschlüssel, extra kurz, für Motorrad-Hinterradmuttern
 Douille 12-pans, extra-court, pour moto, pour écrou roue-arrière







6405A		D ₁ (mm)	D ₂ (mm)	H (mm)	L (mm)	 (g)	 (pcs.)
2.3/16MV		74.6	53	23	52	790	2



4012M-43  Inhex Sockets
 Steckschlüssel für Innensechskant-Schrauben
 Douilles tournevis pour vis 6-pans creux



4012M-43 (mm)		D (mm)	H (mm)	L (mm)	 (g)	 (pcs.)
20		26	11.5	43	130	10
21		26	11.5	43	140	10
22		26	11.5	43	145	10
23		28	11.5	43	170	10
24		28	11.5	43	170	10
27		32	11.5	43	226	10





3305P (mm)		D (mm)	H (mm)	L (mm)	(g)	(pcs.)
12	3/8"	16.5	6.3	70	78	10

3305P-12 : For DUCATI V4 Engines



The magnet could be broken with any impacts. Please handle with care.

155	D (mm)	d (mm)	L (mm)	(g)	(pcs.)
	22	10	170	100	10

For Motorcycles
 Für Motorräder
 Pour motos



3305P-12 Spark Plug Socket with Magnet, 12-pt. opening
 Zündkerzensteckschlüssel mit Magnet, 12-kant
 Douille pour bougies, avec aimant, 12-pans

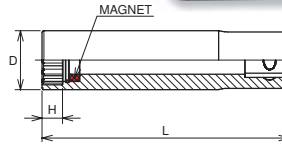

155
 Tyre Lever
 Reifen und Montagehebel
 Démonte-pneu

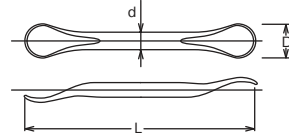

104ME (mm)	D (mm)	H (mm)	L ₁ (mm)	L ₂ (mm)	(g)	(pce.)
6	9.5	8	200	180	150	1
7	11	9	200	180	152	1
8	12	10	250	200	183	1
9	14	12	250	200	188	1
10	14	13	250	200	230	1
11	16	14	250	200	234	1
12	18	15	250	200	355	1
13	18.5	17	250	250	390	1
14	20	18	250	250	399	1
15	21	19	250	250	404	1
16	22.5	21	250	250	419	1
17	24	22	250	250	568	1
18	25	23	250	250	577	1
19	26.5	25	250	250	594	1

104ME T-Handles, 6-Point
 T-Griffe, 6-kant
 Poignées en T, 6-pans

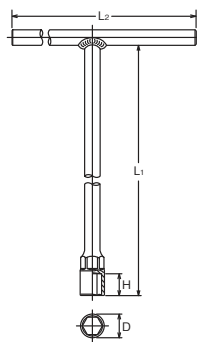

157HE (mm)	L ₁ (mm)	L ₂ (mm)	(g)	(pce.)
3	250	180	98	1
4	250	180	121	1
5	250	180	158	1
6	250	180	416	1
8	250	180	422	1
10	300	190	440	1
12	320	210	660	1

157PE (PH)	L ₁ (mm)	L ₂ (mm)	(g)	(pce.)
2	250	180	95	1
3	250	180	170	1

157T (T)	L ₁ (mm)	L ₂ (mm)	(g)	(pce.)
T25	250	180	95	1
T27	250	180	96	1
T30	250	180	167	1
T40	250	180	168	1
T45	250	180	213	1
T50	250	180	215	1

157HE T-Handles, for Inhex Screws
 T-Griffe für Innensechskant-Schrauben
 Poignées en T, pour vis à 6-pans creux

157PE T-Handles for PH Screws
 T-Griffe für Kreuzschlitzschrauben PH
 Poignées en T, pour vis à empreinte PH



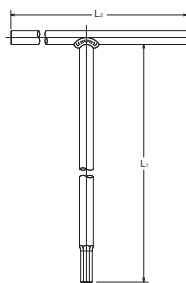



157T T-Handle for TORX® Screws
 T-Griff für TORX®-Schrauben
 Poignées en T pour vis à empreinte TORX®

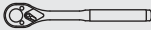

Z-SERIES
 HAND
 TITANIUM
 ACCESSORIES
 SCREWDRIVERS
 IMPACT
 SLEEVE-DRIVE
 PROTECTOR
 INDUSTRIAL
 AUTOMOTIVE
 MOTORCYCLE
 CONSTRUCTION
 SPARE PART





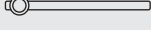



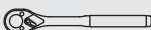

2263A 1/4" Socket set (Inch)
 1/4" Steckschlüsselsatz (Zoll)
 1/4" Jeu de clés à douilles (Pouce)



2263A		29 Pieces Set/△=940g	
METAL CASE:W240×H100×T32mm			
Sockets		Accessories	
	2400A 6-pt. Sockets 1/8, 5/32, 3/16, 7/32, 1/4, 9/32, 5/16, 11/32, 3/8, 7/16, 1/2		2753N
	2000.28 Bit Sockets 1, 2, 3		2760-100
	2010A.25 Bit Sockets 1/8, 5/32, 3/16, 7/32, 1/4, 9/32, 5/16		2769N-150
	2025.28 Bit Sockets T10, T15, T20, T25, T30		2770
			2785



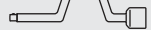
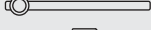



3201AMW 3/8" Socket set (mixed Metric,Inch,Witworth)
 3/8" Steckschlüsselsatz (gemischt Metrisch,Zoll.)
 Jeu de douilles 3/8" (pouce et métrique)

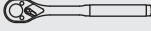

3201AMW		42 Pieces Set/△=4,700g	
METAL CASE:W445×H190×T50mm			
Sockets		Accessories	
	3405M 12-pt. Sockets 9, 10, 11, 12, 13, 14, 15, 16, 17, 18, 19, 20, 21, 22		3753N
	3405A 12-pt. Sockets 5/16, 3/8, 7/16, 1/2, 9/16, 5/8, 11/16, 3/4, 25/32, 13/16, 7/8		3760-75
	3405W 12-pt. Sockets 1/8, 3/16, 1/4, 5/16, 3/8, 7/16, 1/2		3760-125
			3760-250
			3768N-250
			3769N-160
			3770
			3780
			3785
			3344A

4238AM 1/2" Socket set (mixed Metric,Inch)
 1/2" Steckschlüsselsatz (gemischt Metrisch,Zoll)
 Jeu de douilles 1/2" (pouce et métrique)

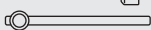
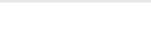

4238AM		38 Pieces Set/△=8,050g	
METAL CASE:W446×H266×T50mm			
Sockets		Accessories	
	4405M 12-pt. Sockets 10, 11, 12, 13, 14, 15, 16, 17, 18, 19, 21, 22, 23, 24, 26, 27, 30, 32		4753N
	4405A 12-pt. Sockets 3/8, 7/16, 1/2, 9/16, 5/8, 11/16, 3/4, 13/16, 7/8, 15/16, 1.1/16, 1.1/8, 1.1/4		4760-125
	4300C Spark Plug Socket 20.8		4760-250
			4770
			4780
			4785

4251A 1/2" Socket set (Inch)
 1/2" Steckschlüsselsatz (Zoll)
 Jeu de douilles (pouce) 1/2"



4251A		18 Pieces Set/△=2,660g	
METAL CASE:W330×H68×T48mm			
Sockets			
	4405A 12-pt. Sockets 3/8, 7/16, 1/2, 9/16, 5/8, 19/32, 21/32, 11/16, 3/4, 25/32, 13/16, 7/8, 15/16, 1, 1.1/16, 1.1/8, 1.3/16, 1.1/4		

**TOOLS FOR CONSTRUCTION SITES
WERKZEUGE FÜR DAS BAUGEWERBE
OUTILLAGE POUR L'INDUSTRIE DU BÂTIMENT**



Z-SERIES
 HAND
 TITANIUM
 SCREWDRIVERS ACCESSORIES
 IMPACT
 SLEEVE-DRIVE
 PROTECTOR
 INDUSTRIAL
 AUTOMOTIVE
 MOTORCYCLE
 CONSTRUCTION
 SPARE PART

BD014SE 12-point Nut Setters
 12-kant Steckschlüsselklingen
 Douilles 12-pans à embout

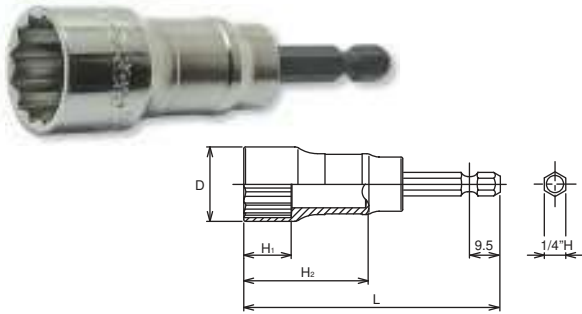

BD014SE (mm)	D (mm)	H ₁ (mm)	H ₂ (mm)	L (mm)	(g)	(pcs.)
8	12	12	36	77	35	10
10	14	12	36	77	38	10
12	16.5	14	36	77	48	10
13	17.5	14	36	77	51	10
14	19	14	36	77	54	10
17	22.5	14	36	77	76	10
19	24.5	14	36	77	83	10
21	27	14	34	77	104	10
22	28	14	34	77	120	10
24	30.3	14	34	77	140	10

● DIN 3126 Form E 6.3

BD014E 12-point Nut Setters, deep
 12-kant Steckschlüsselklingen, lang
 Douilles longues, 12-pans à embout

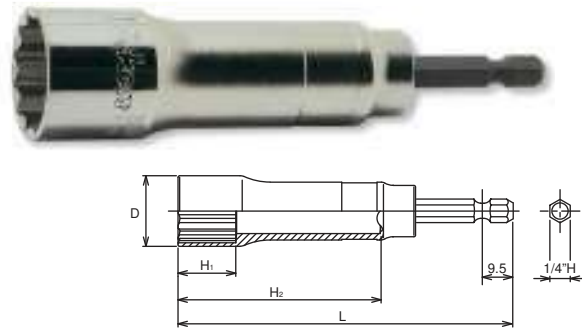

BD014E (mm)	D (mm)	H ₁ (mm)	H ₂ (mm)	L (mm)	(g)	(pcs.)
8	12	12	63	104	45	10
10	14	12	63	104	52	10
12	16.5	18	63	104	61	10
13	17.5	18	63	104	65	10
14	19	18	63	104	72	10
17	22.5	18	60	104	80	10
19	24.5	18	60	104	95	10
21	27	18	60	104	110	10
22	28	18	60	104	112	10
24	30.3	18	60	104	123	10

● DIN 3126 Form E 6.3

BD014E-140 6-point Nut Setters, extra deep
 6-kant Steckschlüsselklingen, extra lang
 Douilles extra-longues, 6-pans à embout

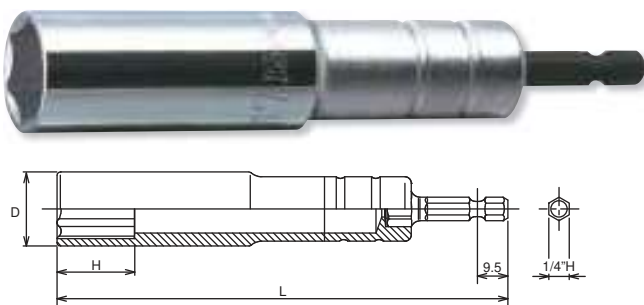

BD014E-140 (mm)	D (mm)	H (mm)	L (mm)	(g)	(pcs.)
13	19	20	140	120	10
17	24	26	140	190	10

● DIN 3126 Form E 6.3

BD042E 6-point Nut Setters, deep (Exchangeable Drive Shank)
 6-kant Steckschlüsselklingen, lang
 Douilles longues, 6-pans à embout

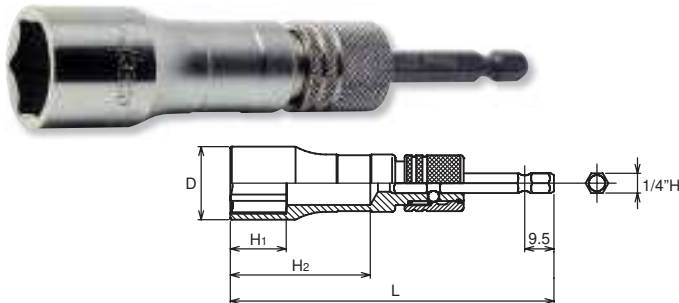

BD042E (mm)	D (mm)	H ₁ (mm)	H ₂ (mm)	L (mm)	(g)	(pcs.)
New 17	23.5	18	45	111	114	10
New 19	25.5	18	45	111	119	10
New 21	28	18	45	111	132	10
New 24	31.5	18	45	111	147	10

● DIN 3126 Form E 6.3

BIT-60E Bits
 Bits
 Enbouts

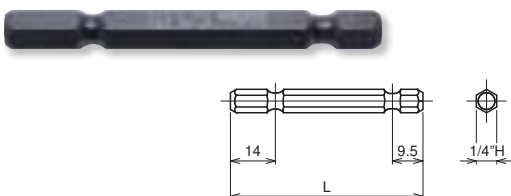

BIT-60E	L (mm)	(g)	(pcs.)
New BIT-60E	60	10	10

● DIN 3126 Form E 6.3

BD014XE (mm)	D (mm)	H ₁ (mm)	H ₂ (mm)	L (mm)	(g)	(pcs.)
8SF	13	12	49	90	40	10
10SF	15	12	49	90	46	10
12SF	17.5	14	48	90	54	10
13SF	18.5	14	48	90	58	10
14SF	19.8	14	47	90	64	10
17SF	23.5	14	46	90	81	10
19SF	25.5	14	46	90	100	10
21SF	28	14	46	90	123	10
24SF	31.5	14	45	90	137	10

◆ DIN 3126 Form E 6.3



BD014XE-SF

Surface Drive Nut Setters, Semi-Deep
Surface Drive Steckschlüsselklingen, mittel lang
Douilles semi-profondes, Surface Drive

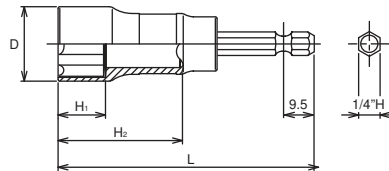

BD014E (mm)	D (mm)	H ₁ (mm)	H ₂ (mm)	L (mm)	(g)	(pcs.)
17SF	23.5	18	60	104	94	10
19SF	25.5	18	60	104	100	10
21SF	28	18	60	104	110	10

◆ DIN 3126 Form E 6.3



BD014E-SF

Surface Drive Nut Setters, deep
Surface Drive Steckschlüsselklingen, lang
Douilles longues, Surface Drive

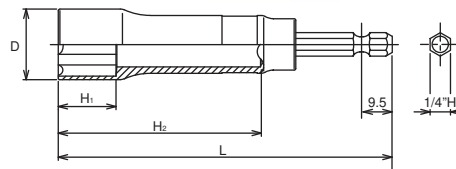

BD008E-165 (mm)	D (mm)	H ₁ (mm)	H ₂ (mm)	L (mm)	(g)	(pcs.)
17	22.8	17	110	165	105	10
19	24.8	17	110	165	135	10
21	27.3	17	110	165	142	10

◆ DIN 3126 Form E 6.3

BD008E-165

12-point Nut Setter, extra long
12-kant Steckschlüsselklinge, extra lang
Douilles 12-pans à embout, extra longues

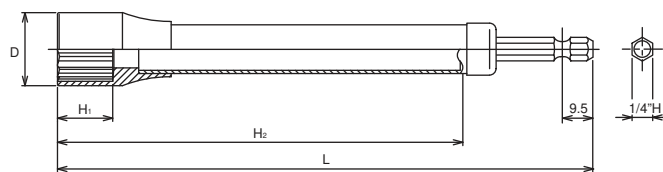

BD011SE (mm)	D (mm)	H ₁ (mm)	H ₂ (mm)	L (mm)	(g)	(pcs.)
10	14	12	35	100	73	10
12	16.5	12	35	100	77	10
13	17.5	12	35	100	79	10
14	19	12	32	100	82	10
17	22.5	14	32	100	87	10
19	24.5	14	30	100	94	10
21	27	14	30	100	103	10
22	28	14	30	100	104	10

◆ DIN 3126 Form E 6.3

BD011SE



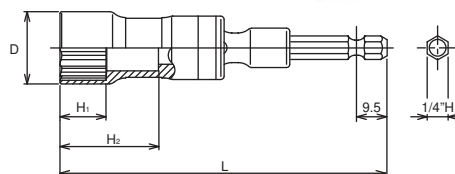

12-point Universal Joint Nut Setters
12-kant Steckschlüsselklingen mit Gelenk
Douilles 12-pans articulées à embout

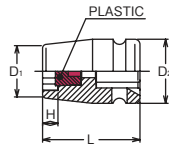

Z-SERIES
 HAND
 TITANIUM
 SCREWDRIVERS ACCESSORIES
 IMPACT
 SLEEVE-DRIVE
 PROTECTOR
 INDUSTRIAL
 AUTOMOTIVE
 MOTORCYCLE
 CONSTRUCTION
 SPARE PART

BD14400MJ  6-point Sockets for Anchor Screws
 6-kant Steckschlüssel
 Douilles 6-pans





BD14400MJ (mm)		D ₁ (mm)	D ₂ (mm)	H (mm)	L (mm)	 (g)	 (pcs.)	
13	1/2"	20.7	25	5	38	140	10	*1
15		23.2	30	5	38	145	10	*2
16		24.5	30	6.5	38	145	10	*2
17		25.7	30	6.5	38	145	10	*2
19		28.2	30	7.5	38	145	10	*2

*1 C-Ring=C41, Pin/O-Ring=A41/B41
 *2 C-Ring=C42, Pin/O-Ring=A42/B42  P256-257

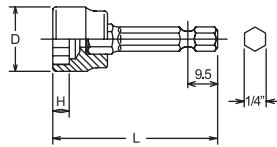
BD016E  6-point Sockets for Anchor Screws
 6-kant Steckschlüssel
 Douilles 6-pans





BD016E (mm)	D (mm)	H (mm)	L (mm)	 (g)	 (pcs.)
13	19.5	4	50	43	10
17	24.5	5	50	56	10
19	27	6	50	68	10

● DIN 3126 Form E 6.3

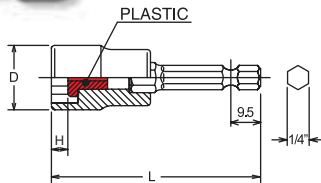
BD016JE  6-point Nut Setters with Plastic Stops
 6-kant Steckschlüsselklingen mit Plastik-Anschlag
 Douilles 6-pans à embout avec arrêt en plastique





BD016JE (mm)	D (mm)	H (mm)	L (mm)	 (g)	 (pcs.)
13	19.5	5	60	66	10
17	24.5	6.5	60	80	10
19	27	7.5	60	90	10

● DIN 3126 Form E 6.3

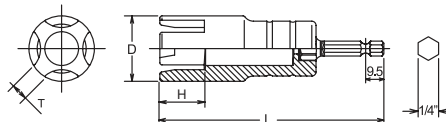
BD017E Wing Bolt Socket for Electric Drill
 6-kant Steckschlüsselklingen für Flügelschrauben
 Douilles 6-pans à embout pour ecrous à oreilles



BD017E	D (mm)	T (mm)	H (mm)	L (mm)	 (g)	 (pcs.)
	31	7.3	21	104	158	10

● DIN 3126 Form E 6.3



BD018		D (mm)	T (mm)	H (mm)	L (mm)	(g)	(pcs.)	
	$\frac{3}{8}$ "	31	7.3	21	45	113	10	*2

*2 C-Ring=C32, Pin/O-Ring=A32/B32 → P256-257

BD018 Wing Bolt Socket
Steckschlüssel für Flügelschrauben
Douilles pour écrous à oreilles

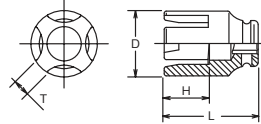

3119		T ₁ ×T ₂ (mm)	D ₁ (mm)	D ₂ (mm)	d (mm)	L (mm)	(g)	(pcs.)
3 × 5	$\frac{3}{8}$ "	3 × 5	17	17.3	11	30	30	10
5.5 × 6		5.5 × 6	21	19.5	14	33	45	10



For Wing Bolt
Für Flügelschrauben
Pour écrous à oreilles



For Drain Plug in Radiator
Für Kühler-Ablassschrauben
Pour le vidange du radiateur

3119 Wing Bolt Socket
Steckschlüssel für Flügelschrauben
Douilles pour écrous à oreilles

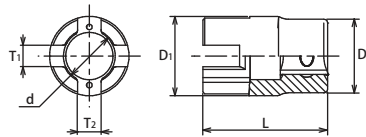

162E (mm)	D (mm)	L (mm)	(g)	(pcs.)
8	23	66	82	10
10	27.9	66	107	10

162E (inch)	D (mm)	L (mm)	(g)	(pcs.)
1/4	23	66	83	10
5/16	23	66	82	10
3/8	27.9	66	107	10
1/2	27.9	66	108	10

◆ DIN 3126 Form E 6.3

162E Stud Setters
Stehbolzeneindreher
Monte-goujons

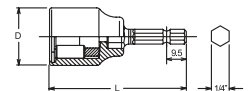
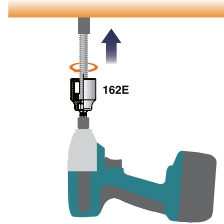

BD004 (mm)		D ₁ (mm)	D ₂ (mm)	L (mm)	(g)	(pcs.)
12.5×10	$\frac{1}{2}$ "	30	25	70	236	5
12.5×13		38	30	75	388	5
12.5×16		38	30	75	369	5
20 × 19	$\frac{3}{4}$ "	48	44	90	775	2
20 × 22		48	44	90	752	2
20 × 25		62	44	95	1184	2
20 × 29		62	44	95	1148	2



BD004 Impact Screw and Stud Setters
Impact Stehbolzeneindreher
Monte goujons, Impact

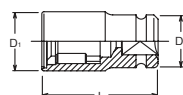

Z-SERIES
 HAND
 TITANIUM
 ACCESSORIES
 SCREWDRIVERS
 IMPACT
 SLEEVE-DRIVE
 PROTECTOR
 INDUSTRIAL
 AUTOMOTIVE
 MOTORCYCLE
 CONSTRUCTION
 SPARE PART

HA001 Stud Setters
 Stehbolzeneindreher
 Monte-goujons

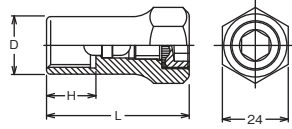

HA001	D (mm)	H (mm)	L (mm)	(g)	(pcs.)
10(1.5)	15.5	13	47	90	10
12(1.75)	17.2	15	49	100	10
16(2.0)	21	18	52	125	10
20(2.5)	24.5	21	56	155	10
22(2.5)	26.5	27	61	175	10
24(3.0)	28	28	62	185	10

HA003 Drive Part
 Antriebsteil
 Propulseur

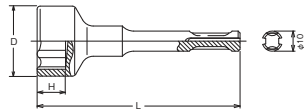

HA003 (mm)	D (mm)	H (mm)	L (mm)	(g)	(pcs.)
24	34.5	14	100	155	10

Socket for HA001



BD022-120P Hammer Drill Adaptor
 Adapter für Schlagbohrmaschinen
 Adaptateur pour aléseuses

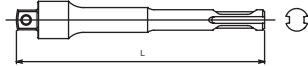

BD022-120P		L (mm)	(g)	(pcs.)
3/8	3/8"	120	100	10
1/2	1/2"	120	160	10

BD023E Adaptors
 Verbindungsstücke
 Adaptateurs

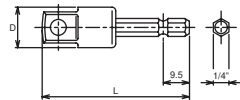

BD023E		D (mm)	L (mm)	(g)	(pcs.)
3/8	3/8"	12.5	55	27	10
1/2	1/2"	16.5	60	48	10

● DIN 3126 Form E 6.3

BD024E Universal Adaptors
 Gelenk Adapter
 Augmentator articulé

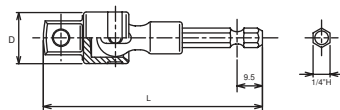

BD024E		D (mm)	L (mm)	(g)	(pcs.)
3/8	3/8"	19.3	78	63	10
1/2	1/2"	19.3	82	73	10

● DIN 3126 Form E 6.3

170S (mm)	D (mm)	T (mm)	L (mm)	(g)	(pce.)
10×12	34	38	250	260	1
12×14	34	38	250	260	1

171S (mm)	D (mm)	T (mm)	L (mm)	(g)	(pce.)
14×17	44.6	50	250	460	1
17×19	44.6	50	250	460	1
17×21	44.6	50	250	460	1
19×21	44.6	50	250	460	1

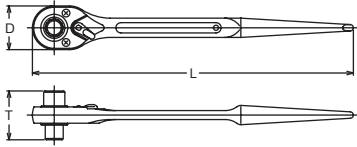

170S ○ Spud Handle Ratchets, reversible
Doppelseitige Gerüstbauknarre, umstellbar
Cliquets, réversibles, pour assemblage et démontage - échafaudages, manche pointu

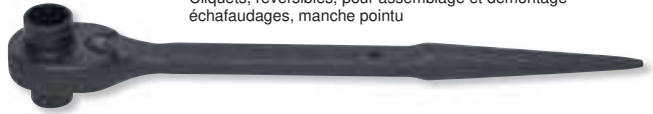

171S ○ Spud Handle Ratchets, reversible
Doppelseitige Gerüstbauknarre, umstellbar
Cliquets, réversibles, pour assemblage et démontage - échafaudages, manche pointu



171 ○ Spud Handle Ratchets (Long), reversible
Doppelseitige Gerüstbauknarre, lange Ausführung, umstellbar
Cliquets longs, réversibles, pour assemblage et démontage - échafaudages, manche pointu

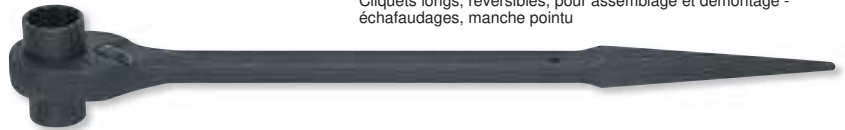

171 (mm)	D (mm)	T (mm)	L (mm)	(g)	(pce.)
14×17	44.6	50	380	630	1
17×19	44.6	50	380	630	1
17×21	44.6	50	380	630	1
19×21	44.6	50	380	630	1

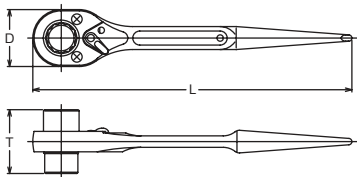

172 ○ Spud Handle Ratchets (Long), reversible
Doppelseitige Gerüstbauknarre, lange Ausführung, umstellbar
Cliquets longs, réversibles, pour assemblage et démontage - échafaudages, manche pointu



172 (mm)	D (mm)	T (mm)	L (mm)	(g)	(pce.)
21×26	68	58	380	1100	1
22×24	68	58	380	1100	1
23×26	68	58	380	1100	1
24×27	68	58	380	1100	1
26×32	68	63	380	1100	1

171SB-1/2	(mm)	D (mm)	T (mm)	L (mm)	(g)	(pce.)
1/2"	44.6	33	250	480	1	

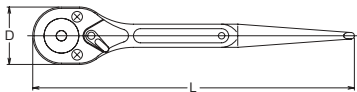

171SB-1/2 Spud Handle Ratchet with Push Button (short)



171B-1/2	(mm)	D (mm)	T (mm)	L (mm)	(g)	(pce.)
1/2"	44.6	33	380	650	1	



171B-1/2 Spud Handle Ratchet with Push Button (Long)

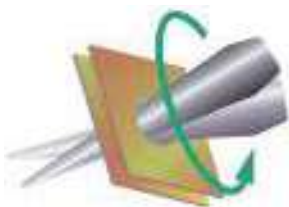

Twin Opening Spud Handle Ratchets
The tapered handle is designed to align bolt holes in flanges, rivet holes or similar assemblies.

Knarren mit doppelseitiger Steckschlüssel-Kombination und konischem Griff für die Ausrichtung von Bohrlöchern z. B. an Flanschen und Gerüsten.

Cliquets à tête double avec manche conique pour aligner les trous des boulons lors des travaux d'échafaudage ou de tout travail de construction.



Ko-ken welcomes customer's enquiries for special tools.
New items can be designed and manufactured according to customers
requirements. Please enquire through your distributors.

Wir nehmen auch gerne Ihre Anfrage für Sonderartikel entgegen.
Sonderartikel fertigen wir nach Ihren Anweisungen.
Richten Sie Ihre Anfragen bitte an Ihren örtlichen Händler.

Nous étudierons volontier toute demande d'outils spéciaux.
Nous pouvons concevoir et fabriquer tout outil selon vos spécifications.
Veuillez contacter votre distributeur habituel.

**SPARE PART SETS
ERSATZTEILSÄTZE
PIÈCES DE RECHANGE**



Spare Part Sets
Ersatzteilsätze
Pièces de rechange

Z-SERIES
HAND
TITANIUM
ACCESSORIES
SCREWDRIVERS
IMPACT
SLEEVE-DRIVE
PROTECTOR
INDUSTRIAL
AUTOMOTIVE
MOTORCYCLE
CONSTRUCTION
SPARE PART

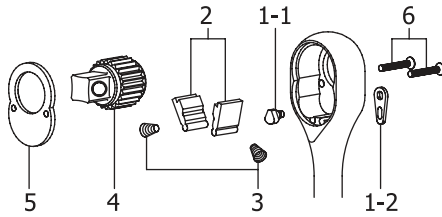

- 1-1 Reversion Cam
- 1-2 Reversion Lever
- 2 Dog
- 3 Spring
- 4 Square Drive
- 5 Cover plate
- 6 Screw

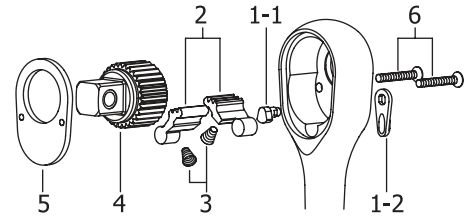

- 1-1 Reversion Cam
- 1-2 Reversion Lever
- 2 Dog
- 3 Spring
- 4 Square Drive
- 5 Cover plate
- 6 Screw

	▣	Products	(g)	(pce.)
2749RK	1/4"	2749N/P/J	30	1
2753RK		2753N/P/J, 2753PS/PSKR, 2753P-160, 2774PS/JS, 2774N/P/J	30	1
2753BRK		2753NB/PB/JB	31	1
2749RK-3/8	3/8"	2749PS-3/8, 2749N-3/8, 2749P-3/8, 2774PS-3/8, 2774JS-3/8	45	1
3749RK		3749S, 3749N	70	1
3749BRK	1/2"	3749SB	84	1
3753RK		3753N/P/J, 3753SM, 3753P-250, 3774N/P/J, 3774PS, 3774NL/PL/JL	84	1
3753BRK		3753NB/PB/JB, 3753SMB, 3774NB/PB/JB/JBL	76	1
3749SRK-1/2	1/2"	3749S-1/2	120	1
3749SBRK-1/2		3749SB-1/2	120	1
4749RK	3/4"	4749N-250, 4749N-380, 4749J-380	130	1
4753RK		4753N/P/J, 4753P-410, 4774N/P/J, 4774P-450	130	1
4753BRK		4753NB/PB/JB, 4774NB/PB/JB	130	1
6749RK	1"	6749, 6749-1000	580	1
8749RK	1"	8749, 8749-1000	800	1

	▣	Products	(g)	(pce.)
4750RK	1/2"	4750N/P/J	130	1
4750BRK		4750NB/PB/JB	130	1

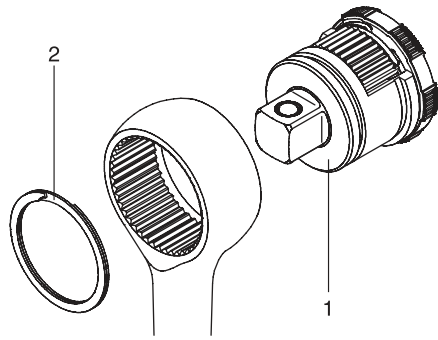

1 Head
2 Retaining Ring

	□	Products	(g)	(pce.)
3752RK	3/8"	3752N/J, 3757, 3776N/P/J	84	1
4752RK	1/2"	4752N/J	140	1

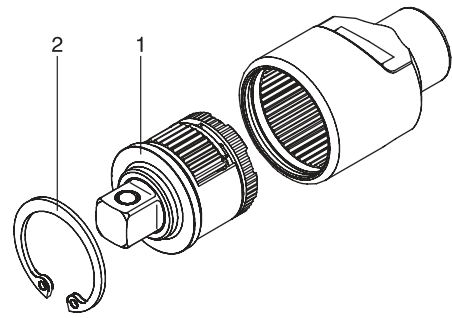

1 Head
2 Retaining Ring

	□	Products	(g)	(pce.)
2755RK	1/4"	2755	40	1
3755RK	3/8"	3755	98	1
4755RK	1/2"	4755	137	1
6755RK	3/4"	6755	550	1

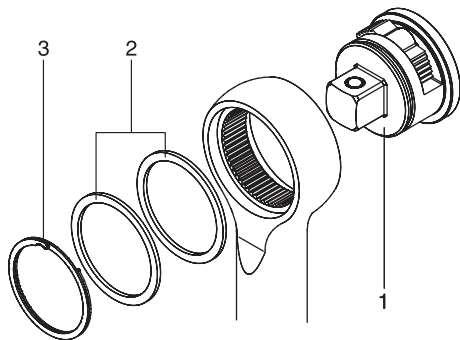

1 Head
2 Ring
3 Retaining Ring

	□	Products	(g)	(pce.)
6752RK	3/4"	6752	600	1

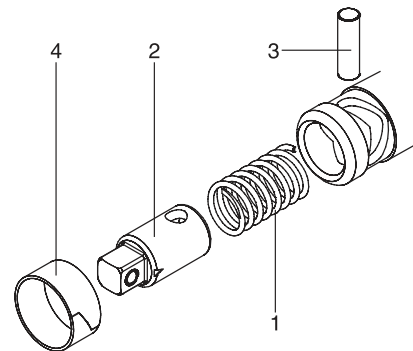

1 Spring
2 Square Drive
3 Pin
4 Retaining Ring

	□	Products	(g)	(pce.)
3112RK	3/8"	3112N	106	1
4112RK	1/2"	4112N	116	1
6112RK	3/4"	6112	445	1

Spare Part Sets
Ersatzteilsätze
Pièces de rechange

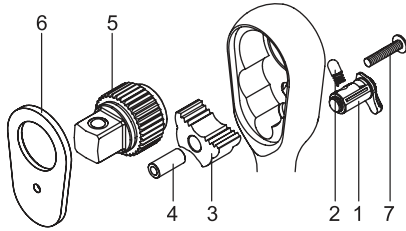

- 1 Reversion Lever
- 2 Pin+Spring
- 3 Pawl
- 4 Sleeve
- 5 Square Drive
- 6 Cover Plate
- 7 Screw

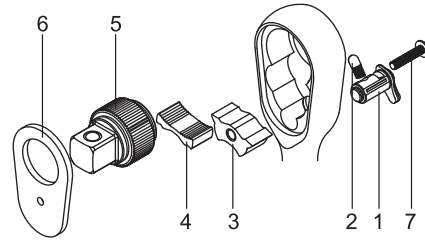

- 1 Reversion Lever
- 2 Pin+Spring
- 3 Pawl (Large)
- 4 Pawl (Small)
- 5 Square Drive
- 6 Cover Plate
- 7 Screw

	▣	Products	(g)	(pce.)
2725RK	1/4"	2725Z, 2725Z-160, 2726Z, 2726Z-160	30	1
2725RK-3/8	3/8"	2725Z-3/8, 2725Z-3/8(L160), 2726Z-3/8, 2726Z-3/8(L160)	45	1
4725RK	1/2"	4725Z	120	1

	▣	Products	(g)	(pce.)
New 3725RK	3/8"	3725Z, 3725ZS, 3725Z-280, 3726Z, 3726ZS, 3726Z-280	50	1



TORXPLUS® 6IP Screwdriver for 2725RK
TORXPLUS® 8IP Screwdriver for 3725RK
TORXPLUS® 10IP Screwdriver for 4725RK

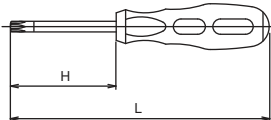

168T (IP)	H (mm)	L (mm)	(g)	(pce.)
6IP(40)	40	110	20	1
8IP(40)	40	110	20	1
10IP(40)	40	110	22	1

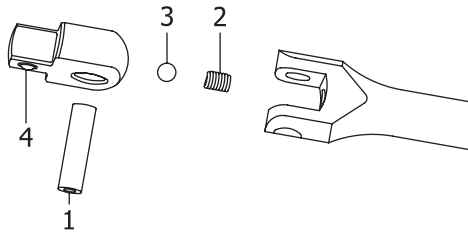

- 1 Pin
- 2 Coil Spring
- 3 Ball
- 4 Square Drive

	▣	Products	(g)	(pce.)
2768RK	1/4"	2768N/P/J	40	1
8768RK	1"	8768, 8768-1000	465	1

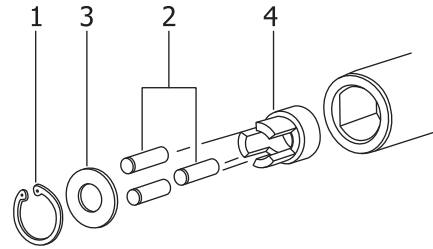

- 1 Retaining Ring
- 2 Roller
- 3 Cover
- 4 Cage

4100MRK (mm)	▣	Products	(pce.)
6	1/2"	4100M-6	1
7		4100M-7	1
8		4100M-8	1
9		4100M-9	1
10		4100M-10	1
10.5		4100M-10.5	1
11		4100M-11	1
12		4100M-12	1
14		4100M-14	1
16		4100M-16	1

4100ARK (inch)	▣	Products	(pce.)
1/4	1/2"	4100A-1/4	1
5/16		4100A-5/16	1
3/8		4100A-3/8	1
7/16		4100A-7/16	1
1/2		4100A-1/2	1
9/16		4100A-9/16	1
5/8		4100A-5/8	1

6100MRK (mm)	▣	Products	(pce.)
18	3/4"	6100M-18	1
20		6100M-20	1
22		6100M-22	1
24		6100M-24	1
27		6100M-27	1
28		6100M-28	1
29		6100M-29	1
30		6100M-30	1

162RK	Products	(pce.)
5/16	162E-5/16	1
3/8	162E-3/8	1
1/2	162E-1/2	1
10	162E-10	1

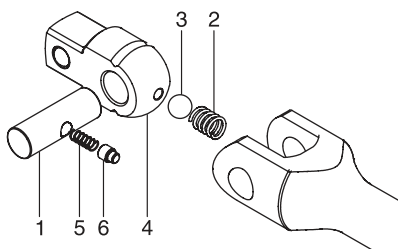

- 1 Pin
- 2 Coil Spring
- 3 Ball
- 4 Square Drive
- 5 Coil Spring
- 6 Plunger



	▣	Products	(g)	(pce.)
3768RK	3/8"	3768N-175/250/300, 3768P-250/380, 3768J-250	40	1
3768ZRK		3768Z-250/400	40	1
4768RK	1/2"	4768N-300/380/450/600, 4768N-380/ 450/600, 4768J-380/450/600, 4781N-450	137	1
4768ZRK		4768Z-430	137	1
6768RK	3/4"	6768, 6768-600, 6768-1000	175	1

HAND SOCKETS/ Diameter of Bore
 HAND STECKSCHLÜSSEL/ Bohrungsdurchmesser
 DOUILLES A MAIN/ Diamètre d'ouverture

Standard Socket



Deep Socket

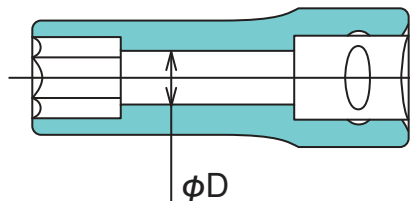
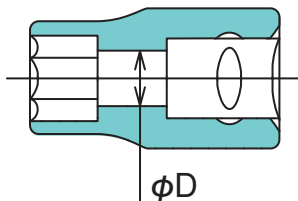

SOCKET		1/4" O		3/8" O		1/2" O		3/4" O		1" O
		Standard	Deep	Standard	Deep	Standard	Deep	Standard	Deep	Standard
		2400M 2400A	2300M 2300A	3400M 3400A	3300M 3300A	4400M 4400A	4300M 4300A	6400M 6400A	6300M 6300A	8400M 8400A
		2405M 2405A	2305M 2305A	3405M 3405A	3305M 3305A	4405M 4405A	4305M 4305A	6405M 6405A	6305M 6305A	8405M 8405A
(mm)	(inch)	ϕD								
3	1/8	2.5	2.5							
4		3	3							
4.5		3.5	3.5							
5	3/16	4	4							
5.5	7/32	4.5	4.5	4.5	4.5					
6	1/4	4.5	5	5	5					
7	9/32	6.2	6	5.5	6					
8	5/16	6.2	7	6	7	6	7			
9	11/32	8.3	8.3	7	8	7	8			
10	3/8	9.4	9	8	9	8	9			
11	7/16	10	10	9	10	9	10			
12		10	11	10	11	10	11			
13	1/2	11.5	12	11	12	11	12			
14	9/16	13	13	13.5	13.5	12	13			
15	19/32			13	14	13	14			
16	5/8			14	15	14	15			
17	21/32			15	16	15	16	15	16	
18	11/16			15	17	15	17	15	17	
19	3/4			16	18	18	18	16	18	
20	25/32			17	19	18	19	17	19	
21	13/16			18	20	18	20	18	20	
22	7/8			19	21	19	21	19	21	
23				20	22	20	22	20	22	
24	15/16			21	23	21	23	21	23	
25				22	24	22	24	22	24	
26	1			23	25	23	25	23	25	
27	1- 1/16				26	23	26	23	26	23
28						24	27	24	27	24
29	1- 1/8					24	28	24	28	24
30	1- 3/16					25	29	25	29	25
31						26	30	26	30	26
32	1- 1/4					27	31	27	31	27
33	1- 5/16					28	32	28	32	28
34						29	33	29	33	29
35	1- 3/8					30	34	30	34	30
36						31	35	31	35	31
37	1- 7/16					31	36	31	36	31
38	1- 1/2					32	37	32	37	32
39								32	38	32
40	1- 9/16							33	39	33
41	1- 5/8							34	40	34
42								34	41	34
43	1-11/16							35	42	35
44	1- 3/4							36	43	36
45								36	44	36
46	1-13/16							37	45	37
47								38	46	38
48	1- 7/8							38	47	38
	1-15/16							39	48	39
50	2							40	49	40
	2- 1/16							40		

IMPACT SOCKETS/ Diameter of Bore
 IMPACT STECKSCHLÜSSEL/ Bohrungsdurchmesser
 DOUILLES IMPACT / Diamètre d'ouverture

Standard Socket

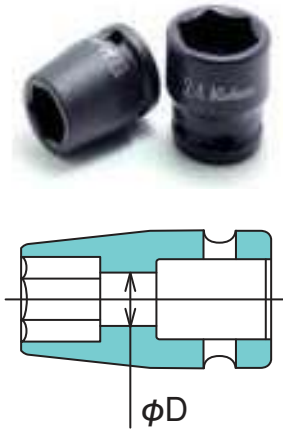

Deep Socket

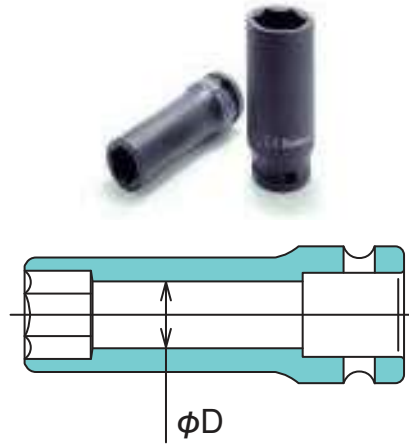

SOCKET		1/4" Ø		3/8" Ø		1/2" Ø		3/4" Ø		1" Ø	
		Standard	Standard	Deep	Standard	Deep	Standard	Deep	Standard	Deep	
Ø		12400M 12400A	13400M 13400A	13300M 13300A	14400M 14400A	14300M 14300A	16400M 16400A	16300M 16300A	18400M 18400A	18300M 18300A	
(mm)	(inch)	φD									
4		3									
4.5	3/16	3									
5		4									
5.5		4									
6	1/4	5	5	5							
7	9/32	5	5	6							
8	5/16	6	6	7	6	7					
9	11/32	7	7	8	7	8					
10	3/8	8	8	9	8	9					
11	7/16	9	9	10	9	10					
12		10	10	11	10	11					
13	1/2	11	11	12	11	12					
14	9/16	12	12	13	12	13					
15			13	14	13	14					
16	5/8		14	15	14	15	14	15			
17	11/16		14	16	14	16	14	16			
18			15	17	15	17	15	17			
19	3/4		16	18	16	18	16	18	16	18	
20			17	19	17	19	17	19	17	19	
21	13/16		18	20	18	20	18	20	18	20	
22	7/8		19	21	19	21	19	21	19	21	
23			20		20	22	20	22	20	22	
24	15/16		20		21	23	21	23	21	23	
25	1				22	24	22	24	22	24	
26					23	25	23	25	23	25	
27	1- 1/16				23	26	23	26	23	26	
28					23	27	24	27	24	27	
29	1- 1/8				23	28	25	28	25	28	
30	1- 3/16				23	29	26	29	26	29	
31					23	30	27	30	27	30	
32	1- 1/4				23	31	28	31	28	31	
33					25	32	29	32	29	32	
34	1- 5/16				25	33	30	33	30	33	
35	1- 3/8				25	34	31	34	31	34	
36					28	35	32	35	32	35	
37	1- 7/16						32	36	32	36	
38	1- 1/2						34	37	34	37	
40	1- 9/16						34	39	34	39	
41	1- 5/8						35	40	35	40	
42	1-11/16						35	41	35	41	
45	1- 3/4						35	44	35	44	
46	1-13/16						40	45	40	45	
47							40	46			
	1- 7/8						40	47			

Screw dimension	Hexagon Head Bolt			Hexagon Socket Head Cap Screws			TORX		TORXPLUS		Triple Square	LHSTIX	Ref.) Standard Tightning Torque (Nm)				
	Standard	Compact	High Strength	Standard	Button Head / Shoulder Head	Hexagon Socket Set Screws	T	E	IP	EP [EPL]	XZN	LH-S [LH-SS]	Grade 4.6	Grade 6.8	Grade 8.8	Grade 10.9	Grade 12.9
M2	4			1.5		0.9	T6/T8		6IP				0.12	0.24	0.32	0.45	0.54
M2.5	5			2		1.3	T8		8IP		M3		0.25	0.49	0.65	0.92	1.1
M3	5.5			2.5	2	1.5	T10	E4	8IP/10IP	4EP	M3		0.43	0.87	1.16	1.63	1.96
M3.5	(6)						T15		10IP/15IP				0.68	1.37	1.82	2.56	3.08
M4	7			3	2.5	2	T20/T25	E5	15IP/20IP	5EP	M4	LH4S	1.01	2.02	2.7	3.79	4.54
M5	8			4	3	2.5	T25/T27	E6	20IP/25IP /27IP	6EP [8EPL]	M5	LH5S	2.04	4.09	5.47	7.67	9.18
M6	10			5	4	3	T30	E8	27IP/30IP	8EP [10EPL]	M6	LH6S	3.47	6.97	9.27	13	15.6
M7	11						T40	E8	40IP	8EP [12EPL]			5.85	11.6	15.5	21.8	26.2
M8	13	(12)		6	5	4	T40/T45	E10	40IP/45IP	10EP [14EPL]	M8	LH8S	8.41	16.9	22.5	31.6	37.9
M10	16 (17)	(14)		8	6	5	T50	E12	45IP/50IP	12EP [16EPL]	M10	LH10S [LH8SS]	16.7	33.4	44.5	62.6	75.2
M12	18 (19)	(17)	21 (22)	10	8	6	T55	E14	55IP	14EP [20EPL]	M12	LH12S [LH10SS]	29.1	58.3	77.6	109	131
M14	21 (22)	(19)		12			T55/T60	E14/E18	55IP/60IP	18EP [24EPL]	M14	LH14S [LH12SS]	46.4	92.7	124	174	209
M16	24	(22)	27	14	10	8	T60/T70	E16/E20	60IP/70IP	20EP [26EPL]	M16	LH16S [LH14SS]	72.3	145	194	271	325
M18	27	(24)		(14)			T70/T80	E24	80IP	24EP [30EPL]	M18		100	199	266	373	447
M20	30 (32)	(27/29)	32	17	12	10	T80/T90	E24	90IP	24EP [32EPL]			141	282	376	529	635
M22	34 (32/35)	(30/32)	36	(17)			T90/T100	E28	100IP	24EP [36EPL]			192	384	511	720	865
M24	36 (38)	(32/35)	41	19		12	T100	E32	100IP	32EP [40EPL]			244	488	650	915	1100
M27	41	(36)	46	(19)				E32		32EP			358	713	951	1340	1610
M30	46	(41)	50	22				E36		36EP			484	971	1290	1820	2180
M33	50	(46)		(24)				E40		40EP			661	1320	1760	2470	2970
M36	55 (54)	(50)		27				E44		44EP			848	1690	2260	3180	3810
M39	60 (58)	(55)		(27)									1100	2190	2920	4110	4930
M42	65 (63)			32									1350	2710	3610	5080	6080
M45	70 (67)			(32)									1700	3400	4540	6370	7630
M48	75 (71)			36									2030	4060	5440	7620	9120
M52	80 (77)			(36)									2640	5290	7040	9880	11800
M56	85			41									3270	6560	8710	12300	14800
M60	90												4080	8180	10900	15300	18300
M64	95			46									4930	9890	13100	18500	22300
M68	(100)												5970	12000	16000	22500	27000

*Reference: Hexagon Head Bolt: ISO 4014-4018, 8676, 8768
 High Strength Hexagon Bolt: JIS B 1196
 Hexagon Socket Head Cap Screws: ISO 7380
 Hexagon Socket Button Head Screws: ISO 7380
 Hexagon Socket Set Screws: ISO 4026-4029
 TORX T/E: TORX Standard TMH series
 TORXPLUS IP/EP: TORXPLUS Standard CMH series
 Triple Square: DIN 2324/2325
 LHSTIX LH-S/SS: LH-S/SS Standard

* Standard Tightening Torque: Calculated based on Torque Coefficient (K): 0.2
 Axial Force (Ff) : 60% of Proof Strength(σ)

TORX is a registered trademark of CAMCAR Innovations.
TORX ist ein registriertes Markenzeichen der Firma CAMCAR Innovations.
TORX est une marque déposée de CAMCAR Innovations.

TORXplus is a registered trademark of CAMCAR Innovations.
TORXplus ist ein registriertes Markenzeichen der Firma CAMCAR Innovations.
TORXplus est une marque déposée de CAMCAR Innovations.

LHSTIX is a registered trademark of OSG SYSTEM PRODUCTS CO., LTD.
LHSTIX ist ein registriertes Markenzeichen der Firma OSG SYSTEM PRODUCTS CO., LTD.
LHSTIX est une marque déposée de OSG SYSTEM PRODUCTS CO., LTD.

TORX® / TORXplus® BITS

		S1 (mm)	S2 (mm)
T6	6IP	1.7	1.2
T7	7IP	2.0	1.4
T8	8IP	2.3	1.7
T9	9IP	2.5	1.8
T10	10IP	2.7	2.0
T15	15IP	3.3	2.3
T20	20IP	3.9	2.8
T25	25IP	4.5	3.2
T27	27IP	5.0	3.6
T30	30IP	5.6	4.0
T40	40IP	6.7	4.8
T45	45IP	7.9	5.6
T50	50IP	8.9	6.2
T55	55IP	11.3	8.0
T60	60IP	13.3	9.5
T70	70IP	15.6	11.1
T80	80IP	17.6	12.7
T90	90IP	20.0	14.2
T100	100IP	22.2	15.8

TORX® / TORXplus® SOCKETS

		S1 (mm)	S2 (mm)
E4	4EP	3.7	2.7
E5	5EP	4.6	3.3
E6	6EP	5.6	4.0
E7	7EP	6.1	4.3
E8	8EP	7.4	5.3
E10	10EP	9.3	6.8
E11	11EP	9.9	7.1
E12	12EP	11.0	7.9
E14	14EP	12.8	9.2
E16	16EP	14.6	10.5
E18	18EP	16.5	11.9
E20	20EP	18.3	13.2
E22	22EP	20.1	14.8
E24	24EP	22.0	15.7
E26	26EP	23.7	17.5
E28	28EP	25.5	18.3
E30	30EP	27.3	20.0
E32	32EP	29.0	21.3

TORXplus® Tamper-Resistant BITS

		S1 (mm)	S2 (mm)
8IPR		2.2	2.0
9IPR		2.4	2.2
10IPR		2.6	2.4
15IPR		3.1	2.8
20IPR		3.6	3.3
25IPR		4.1	3.8
27IPR		4.7	4.3
30IPR		5.2	4.8
40IPR		6.3	5.7
45IPR		7.4	6.7
50IPR		8.4	7.6
55IPR		10.6	9.7

LHSTIX® (LH-S) SOCKETS

		S1 (mm)	S2 (mm)
LH3S		3.8	4.7
LH4S		4.5	6.0
LH5S		5.6	7.5
LH6S		6.8	9.0
LH7S		7.9	10.5
LH8S		9.0	12.0
LH10S		11.3	15.0
LH12S		13.6	18.0
LH14S		15.8	21.0
LH16S		18.1	24.0

XZN BITS

		S1 (mm)	S2 (mm)
M4		3.6	3.1
M5		4.8	4.1
M6		6.1	5.1
M8		7.3	6.1
M10		9.7	8.1
M12		11.5	9.7
M14		13.3	11.2
M16		15.7	13.2
M18		16.9	14.2

Ribe CV BITS

		W (mm)	S1 (mm)	S2 (mm)
M5		1.2	5.0	3.8
M6		1.3	6.0	4.5
M7		1.4	7.0	5.0
M8		1.8	8.0	6.0
M9		2.0	9.0	7.1
M10		2.3	10.0	7.4
M12		2.6	12.0	9.0
M13		3.1	13.0	11.0
M14		3.2	14.0	10.4
M16		3.6	16.0	11.9

TORX® is a registered trademark of CAMCAR Innovations.
 TORX® ist ein registriertes Markenzeichen der Firma CAMCAR Innovations.
 TORX® est une marque déposée de CAMCAR Innovations.

TORXplus® is a registered trademark of CAMCAR Innovations.
 TORXplus® ist ein registriertes Markenzeichen der Firma CAMCAR Innovations.
 TORXplus® est une marque déposée de CAMCAR Innovations.

LHSTIX® is a registered trademark of OSG SYSTEM PRODUCTS CO., LTD.
 LHSTIX® ist ein registriertes Markenzeichen der Firma OSG SYSTEM PRODUCTS CO., LTD.
 LHSTIX® est une marque déposée de OSG SYSTEM PRODUCTS CO., LTD.

Koken		Conversion Table: American Inches-Decimal Inches-Millimeter											
in	dec.in.	0"	1"	2"	3"	4"	5"	6"	7"	8"	9"	10"	11"
		Millimeter(mm)											
1/64	0	0	25.4000	50.8000	76.2000	101.6000	127.0000	152.4000	177.8000	203.2000	228.6000	254.0000	279.4000
1/32	0.01563	0.3969	25.7969	51.1969	76.5969	101.9969	127.3969	152.7969	178.1969	203.5969	228.9969	254.3969	279.7969
3/64	0.04688	1.1906	26.5906	51.9906	77.3906	102.7906	128.1906	153.5906	178.9906	204.3906	229.7906	255.1906	280.5906
1/16	0.06250	1.5875	26.9875	52.3875	77.7875	103.1875	128.5875	153.9875	179.3875	204.7875	230.1875	255.5875	280.9875
5/64	0.07813	1.9844	27.3844	52.7844	78.1844	103.5844	128.9844	154.3844	179.7844	205.1844	230.5844	255.9844	281.3844
3/32	0.09375	2.3813	27.7813	53.1813	78.5813	103.9813	129.3813	154.7813	180.1813	205.5813	230.9813	256.3813	281.7813
7/64	0.10938	2.7781	28.1781	53.5781	78.9781	104.3781	129.7781	155.1781	180.5781	205.9781	231.3781	256.7813	282.1781
1/8	0.12500	3.1750	28.5750	53.9750	79.3750	104.7750	130.1750	155.5750	180.9750	206.3750	231.7750	257.1750	282.5750
9/64	0.14063	3.5719	28.9719	54.3719	79.7719	105.1719	130.5719	155.9719	181.3719	206.7719	232.1719	257.5719	282.9719
5/32	0.15625	3.9688	29.3688	54.7688	80.1688	105.5688	130.9688	156.3688	181.7688	207.1688	232.5688	257.9688	283.3688
11/64	0.17188	4.3656	29.7656	55.1656	80.5656	105.9656	131.3656	156.7656	182.1656	207.5656	232.9656	258.3656	283.7656
3/16	0.18750	4.7625	30.1625	55.5625	80.9625	106.3625	131.7625	157.1625	182.5625	207.9625	233.3625	258.7625	284.1625
13/64	0.20313	5.1594	30.5594	55.9594	81.3594	106.7594	132.1594	157.5594	182.9594	208.3594	233.7594	259.1594	284.5594
7/32	0.21875	5.5563	30.9563	56.3563	81.7563	107.1563	132.5563	157.9563	183.3563	208.7563	234.1563	259.5563	284.9563
15/64	0.23438	5.9531	31.3531	56.7531	82.1531	107.5531	132.9531	158.3531	183.7531	209.1531	234.5531	259.9531	285.3531
1/4	0.25000	6.3500	31.7500	57.1500	82.5500	107.9500	133.3500	158.7500	184.1500	209.5500	234.9500	260.3500	285.7500
17/64	0.26563	6.7469	32.1469	57.5469	82.9469	108.3469	133.7469	159.1469	184.5469	209.9469	235.3469	260.7469	286.1469
9/32	0.28125	7.1438	32.5438	57.9438	83.3438	108.7438	134.1438	159.5438	184.9438	210.3438	235.7438	261.1438	286.5438
19/64	0.29688	7.5406	32.9406	58.3406	83.7406	109.1406	134.5406	159.9406	185.3406	210.7406	236.1406	261.5406	286.9406
5/16	0.31250	7.9375	33.3375	58.7375	84.1375	109.5375	134.9375	160.3375	185.7375	211.1375	236.5375	261.9375	287.3375
21/64	0.32813	8.3344	33.7344	59.1344	84.5344	109.9344	135.3344	160.7344	186.1344	211.5344	236.9344	262.3344	287.7344
11/32	0.34375	8.7313	34.1313	59.5313	84.9313	110.3313	135.7313	161.1313	186.5313	211.9313	237.3313	262.7313	288.1313
23/64	0.35938	9.1281	34.5281	59.9281	85.3281	110.7281	136.1281	161.5281	186.9281	212.3281	237.7281	263.1281	288.5281
3/8	0.37500	9.5250	34.9250	60.3250	85.7250	111.1250	136.5250	161.9250	187.3250	212.7250	238.1250	263.5250	288.9250
25/64	0.39063	9.9219	35.3219	60.7219	86.1219	111.5219	136.9219	162.3219	187.7219	213.1219	238.5219	263.9219	289.3219
13/32	0.40625	10.3188	35.7188	61.1188	86.5188	111.9188	137.3188	162.7188	188.1188	213.5188	238.9188	264.3188	289.7188
27/64	0.42188	10.7156	36.1156	61.5156	86.9156	112.3156	137.7156	163.1156	188.5156	213.9156	239.3156	264.7156	290.1156
7/16	0.43750	11.1125	36.5125	61.9125	87.3125	112.7125	138.1125	163.5125	188.9125	214.3125	239.7125	265.1125	290.5125
29/64	0.45313	11.5094	36.9094	62.3094	87.7094	113.1094	138.5094	163.9094	189.3094	214.7094	240.1094	265.5094	290.9094
15/32	0.46875	11.9063	37.3063	62.7063	88.1063	113.5063	138.9063	164.3063	189.7063	215.1063	240.5063	265.9063	291.3063
31/64	0.48438	12.3031	37.7031	63.1031	88.5031	113.9031	139.3031	164.7031	190.1031	215.5031	240.9031	266.3031	291.7031
1/2	0.50000	12.7000	38.1000	63.5000	88.9000	114.3000	139.7000	165.1000	190.5000	215.9000	241.3000	266.7000	292.1000
33/64	0.51563	13.0969	38.4969	63.8969	89.2969	114.6969	140.0969	165.4969	190.8969	216.2969	241.6969	267.0969	292.4969
17/32	0.53125	13.4938	38.8938	64.2938	89.6938	115.0938	140.4938	165.8938	191.2938	216.6938	242.0938	267.4938	292.8938
35/64	0.54688	13.8906	39.2906	64.6906	90.0906	115.4906	140.8906	166.2906	191.6906	217.0906	242.4906	267.8906	293.2906
9/16	0.56250	14.2875	39.6875	65.0875	90.4875	115.8875	141.2875	166.6875	192.0875	217.4875	242.8875	268.2875	293.6875
37/64	0.57813	14.6844	40.0844	65.4844	90.8844	116.2844	141.6844	167.0844	192.4844	217.8844	243.2844	268.6844	294.0844
19/32	0.59375	15.0813	40.4813	65.8813	91.2813	116.6813	142.0813	167.4813	192.8813	218.2813	243.6813	269.0813	294.4813
39/64	0.60938	15.4781	40.8781	66.2781	91.6781	117.0781	142.4781	167.8781	193.2781	218.6781	244.0781	269.4781	294.8781
5/8	0.62500	15.8750	41.2750	66.6750	92.0750	117.4750	142.8750	168.2750	193.6750	219.0750	244.4750	269.8750	295.2750
41/64	0.64063	16.2719	41.6719	67.0719	92.4719	117.8719	143.2719	168.6719	194.0719	219.4719	244.8719	270.2719	295.6719
21/32	0.65625	16.6688	42.0688	67.4688	92.8688	118.2688	143.6688	169.0688	194.4688	219.8688	245.2688	270.6688	296.0688
43/64	0.67188	17.0656	42.4656	67.8656	93.2656	118.6656	144.0656	169.4656	194.8656	220.2656	245.6656	271.0656	296.4656
11/16	0.68750	17.4625	42.8625	68.2625	93.6625	119.0625	144.4625	169.8625	195.2625	220.6625	246.0625	271.4625	296.8625
45/64	0.70313	17.8594	43.2594	68.6594	94.0594	119.4594	144.8594	170.2594	195.6594	221.0594	246.4594	271.8594	297.2594
23/32	0.71875	18.2563	43.6563	69.0563	94.4563	119.8563	145.2563	170.6563	196.0563	221.4563	246.8563	272.2563	297.6563
47/64	0.73438	18.6531	44.0531	69.4531	94.8531	120.2531	145.6531	171.0531	196.4531	221.8531	247.2531	272.6531	298.0531
3/4	0.75000	19.0500	44.4500	69.8500	95.2500	120.6500	146.0500	171.4500	196.8500	222.2500	247.6500	273.0500	298.4500
49/64	0.76563	19.4469	44.8469	70.2469	95.6469	121.0469	146.4469	171.8469	197.2469	222.6469	248.0469	273.4469	298.8469
25/32	0.78125	19.8438	45.2438	70.6438	96.0438	121.4438	146.8438	172.2438	197.6438	223.0438	248.4438	273.8438	299.2438
51/64	0.79688	20.2406	45.6406	71.0406	96.4406	121.8406	147.2406	172.6406	198.0406	223.4406	248.8406	274.2406	299.6406
13/16	0.81250	20.6375	46.0375	71.4375	96.8375	122.2375	147.6375	173.0375	198.4375	223.8375	249.2375	274.6375	300.0375
53/64	0.82813	21.0344	46.4344	71.8344	97.2344	122.6344	148.0344	173.4344	198.8344	224.2344	249.6344	275.0344	300.4344
27/32	0.84375	21.4313	46.8313	72.2313	97.6313	123.0313	148.4313	173.8313	199.2313	224.6313	250.0313	275.4313	300.8313
55/64	0.85938	21.8281	47.2281	72.6281	98.0281	123.4281	148.8281	174.2281	199.6281	225.0281	250.4281	275.8281	301.2281
7/8	0.87500	22.2250	47.6250	73.0250	98.4250	123.8250	149.2250	174.6250	200.0250	225.4250	250.8250	276.2250	301.6250
57/64	0.89063	22.6219	48.0219	73.4219	98.8219	124.2219	149.6219	175.0219	200.4219	225.8219	251.2219	276.6219	302.0219
29/32	0.90625	23.0188	48.4188	73.8188	99.2188	124.6188	150.0188	175.4188	200.8188	226.2188	251.6188	277.0188	302.4188
59/64	0.92188	23.4156	48.8156	74.2156	99.6156	125.0156	150.4156	175.8156	201.2156	226.6156	252.0156	277.4156	302.8156
15/16	0.93750	23.8125	49.2125	74.6125	100.0125	125.4125	150.8125	176.2125	201.6125	227.0125	252.4125	277.8125	303.2125
61/64	0.95313	24.2094	49.6094	75.0094	100.4094	125.8094	151.2094	176.6094	202.0094	227.4094	252.8094	278.2094	303.6094
31/32	0.96875	24.6063	50.0063	75.4063	100.8063	126.2063	151.6063	177.0063	202.4063	227.8063	253.2063	278.6063	304.0063
63/64	0.98438	25.0031	50.4031	75.8031	101.2031	126.6031	152.0031	177.4031	202.8031	228.2031	253.6031	279.0031	304.4031
		12"	13"	14"	15"	16"	17"	18"	19"	20"	21"	22"	23"
in.	dec.in.	Millimeter(mm)											
	0	304.8000	330.2000	355.6000	381.0000	406.4000	431.8000	457.2000	482.6000	508.0000	533.4000	558.8000	584.2000
1/32	0.03125	305.5938	330.9938	356.3938	381.7938	407.1938	432.5938	457.9938	483.3938	508.7938	534.1938	559.5938	584.9938
1/16	0.06250	306.3875	331.7875	357.1875	382.5875	407.9875	433.3875	458.7875	484.1875	509.5875	534.9875	560.3875	585.7875
3/32	0.09375	307.1813	332.5813	357.9813	383.3813	408.7813	434.1813	459.5813	484.9813	510.3813	535.7813	561.1813	586.5813
1/8	0.12500	307.9750	333.3750	358.7750	384.1750								

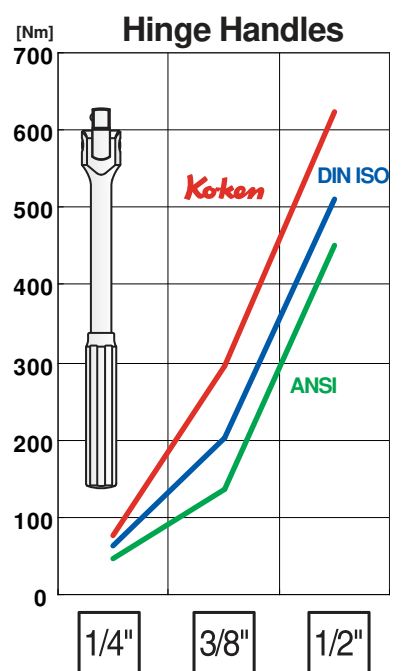
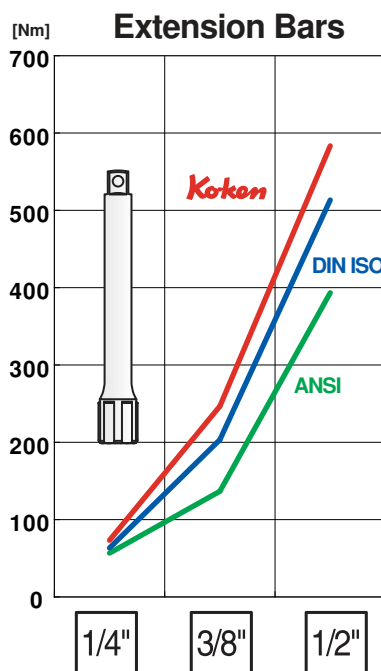
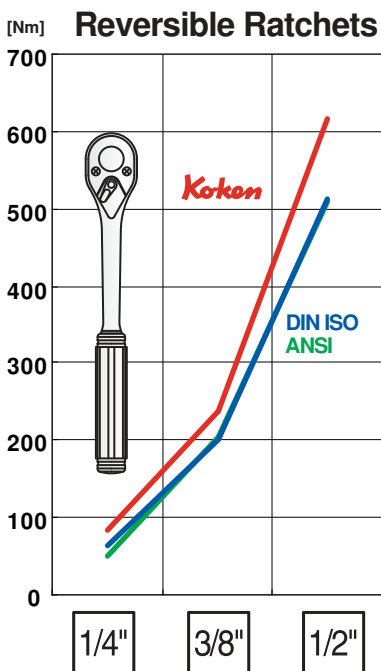
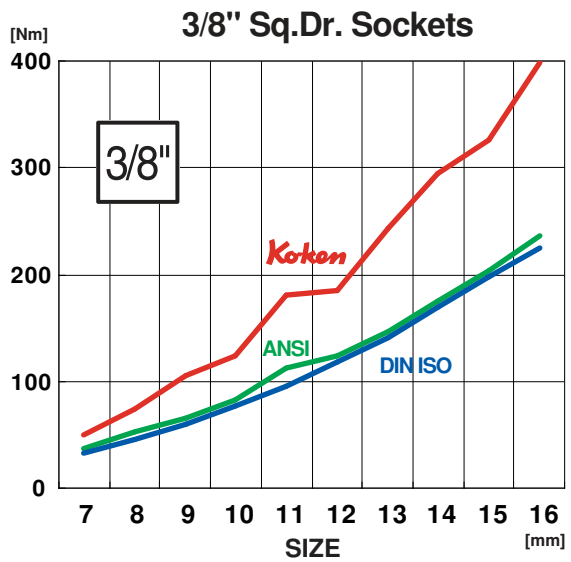
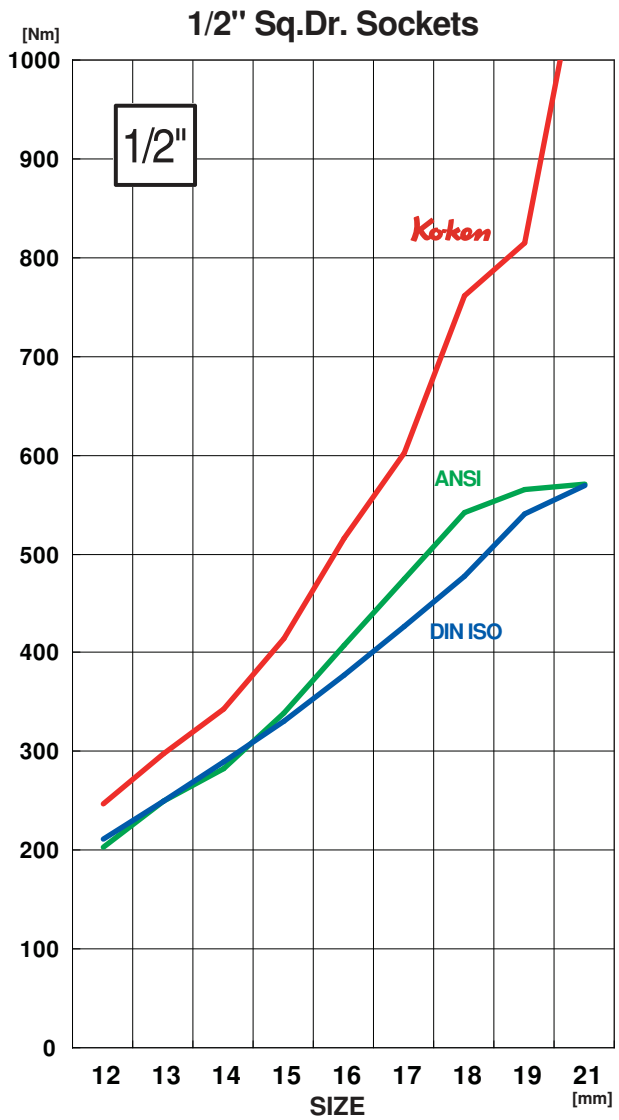
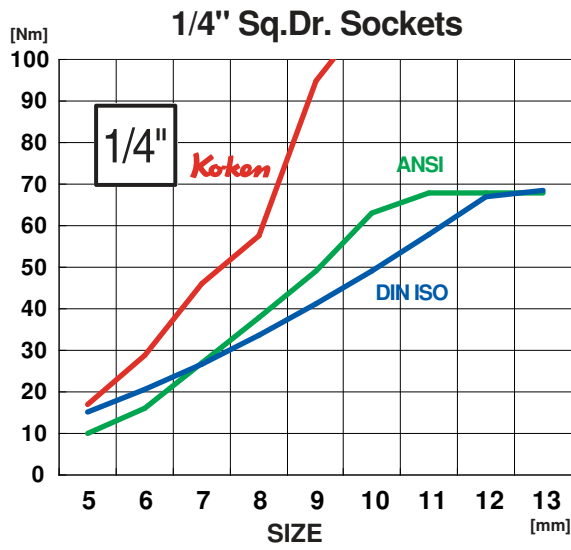

Numerical Index

10099A	248	123PN	162	13425-EPL	184	14310M	205
100H	158	123PT	162	13430M	189	14325	205
100P	158	12400A	178	13440A	189	14365M	205
100P(PZ)	158	12400AG	178	13440M	189	14400A	199
100S	158	12400M	178	13440T	189	14400M	199
100T(T)	158	12400MG	178	13460A	185	14400M-FR	262
100T(TH)	159	12410M	178	13460AG	185	14400MG	201
100X(XZN)	159	12425	179	13460M	185	14400-WN	202
101A	147	12460A	179	13460MG	185	14401A	200
101B	146	12460AG	179	13465M	184	14401LH	201
101H	146	12460M	179	135E	168	14401M	200
101P	146	12460MG	179	137	145	14401MS	201
101S	146	12465M	179	13760	197	14405A	199
101T(T)	146	124M(2B)	150	13760-P	197	14405M	199
101T(TH)	146	12760	181	13760-P.FR	261	14406A	200
102KA	142	12760-P	181	13770	198	14406M	200
102KM	142	12770	181	13770-P	198	14410M	201
102KM.BH	142	12770-P	181	13771	198	14415M	202
102KT	142	127C	273	13771-P	198	14425	202
102NA	142	128H	147	13772-B	198, 283	14425-EPL	202
102NM	142	128T	147	13772-P	198, 283	14433A	216
103KA	143	13012M	192	138	145	14433A-P	216
103KA.BH	143	13025	192	139	145	14440A	206
103KM	143	13103M	137, 189	14012M	209	14440M	206
103KT	143	13134	167, 193	14025	209	14444AL	215
10400A	248	13134M	195	141	136	14455A	216
10400M	248	13134T(IP)	195	14100A	135, 206	14465M	202
104A	149	13134T(T)	195	14100M	135, 206	14466A	216
104ME	149, 295	13134X(XZN)	195	14101M	289	14466A-B	292
106	279	13137E	161	14101MP	288	14466AL	215
107-16	213, 228, 238	13139	157, 196	14101MP-M/8	288	14488A-B	292
107-16(IP)	213, 228, 238	13140	159, 196	14103M	137, 206	144KM	275
107-16(T)	213, 228, 238	13142-D6.3	157, 196	14106	213	145KM-10H	143
107-16(XZN)	213, 228, 238	13142-F11.2	167, 193	14112-P	289	145LH3/8F	280
107-22	229, 239	13142-F6.3	161, 196	14113J	286	14760	215
107-22(T)	229, 239	13145A	283	14113M	286	14760-P	215
107-32	240, 244	13145M	190	14118M	286	14760-P.FR	262
108A	156	13145M(12P)	190, 277	14124	287	14770	216
108H	156	13145MG	190	14124/3	287	14770-P	216
108P	156	13146M	191	14134	167, 210	14771	216
108S	156	13147M	191	14134M	212	14771-P	216
108T(T)	156	13241M	198	14134T(IP)	212	14772-B	216, 283
108T(TH)	156	13242M	198	14134T(T)	212	14772-P	216, 283
110	168	13300A	186	14134X(XZN)	212	148KM	275
112	168	13300G	188	14137E	161	150-10H	143
113	163	13300G-FR	261	14139	157, 214	150-14H	280
113(2B)	163	13300M	186	14140	159, 214	15300M	219
113(E)	163	13300M-FR	261	14142-D6.3	157, 214	15310M	219
113-SV	263	13300XG	186	14142-F11.2	167, 210	15400M	219
113UN	165	13301A	187	14142-F6.3	161, 214	15410M	219
115	164	13301M	187	14145A	283	154K	280
115G	165	13301X	186	14145M	207	154M	144
115G-FR	263	13305M	187	14145M-110MB	285	154ML	144
115-SV	263	13306M	187	14145PM	285	155	295
117	168	13310M	188	14146M	208	15544A	220
119	165	13322A	198	14147M	208	15544A-P	220
120	168	13322A-P	198	141P	136	15555AL	220
1201	136	13325	188	141S	136	15566A	220
1202	147	13333AL	197	14201M	285	156M	149
1203	143	13344A	198	14207M	218	15770	220
1206	144, 280	13344A-P	198	14208M	218	157HE	151, 295
1210E	281	13365M	188	14209M	217	157PE	151, 295
1212	282	13400A	182	14210M	217	157S	151
12137E	161	13400AG	182	14210T	217	157T	151, 295
12139	157, 180	13400M	182	14210X	217	158	279
12140	159, 180	13400M-FR	261	14218M	286	160K	138
12142-F6.3	161, 180	13400MG	182	14241M	218	16101M	289
121H	160	13400-WN	185	14242M	218	16102M	290
121P	160	13401A	183	14245M	218	16106	227
121T(IP)	161	13401LH	185	14300A	203	16106-16	227
121T(T)	160	13401M	183	14300G	205	16106-16(T)	227
121T(TH)	161	13401MS	183	14300G-FR	262	16106-16(XZN)	227
12222AL	181	13405A	182	14300M	203	16107	229
12233A	181	13405M	182	14300M-FR	262	16107-22	229
12233A-P	181	13406A	183	14301A	204	16134	167
12300G	180	13406M	183	14301M	204	16201A	231
12300M	180	13410M	184	14301X	203	16201M	231
12365M	180	13425	184	14305M	204, 283	16245M	231
123PG	162	13425EG	184	14306M	204	162E	301

162RK	309	18104M	236	2300A	043	2756	051
16300A	224	18106	237	2300M	043	2756Z	026
16300M	224	18106-16	237	2300MZ	023	2756Z-1/2	026
16301A	225	18106-16(T)	237	2300W-BA	044	2756Z-3/8	026
16301M	225	18106-16(XZN)	237	2300X	042	2760	052
16301X	224	18107	239	2300XZ	023	2760Z	026
16305M	225, 277	18107-22	239	2305A	043	2762	052
16310M	226	18108	240	2305M	043	2763	052
16316A	292	18108-32	240	2310M	044	2768J	053
16316M	292	18300A	235	2325	044	2768P	053
16317A	292	18300M	235	23300A	268	2768RK	309
16317M	292	18301A	236	23300M	268	2769H	053
16325	226	18301M	236	23305M	268	2769N	053, 174
16400A	221	18301X	235	23310M	268	2769NWF	053, 174
16400M	221	18310M	236	23325	268	2770	054
16401A	222	18316A	292	23400A	267	2771	054
16401M	222	18316M	292	23400M	267	2771Z	026
16405A	221	18317A	292	23405M	267	2772Z	026
16405M	221	18317M	292	23410M	267	2774J	051
16410M	222	183H	166, 193, 210, 252	23425	267	2774JS	051
16425	223	183T(IP)	166, 194, 211, 252	2350G-12PSG	275	2774JS-3/8	082
16425-EPL	223	183T(T)	166, 194, 211, 252	2350M	044	2774N	051
165BM	162	183X(XZN)	167, 194, 211, 253	2350X	042	2774P	051
165LM	162	18400A	232	23760-P	268	2774P-1/4HF	157
16644A	230	18400M	232	2400A	040	2774P-5/16HF	159
16644AL	230	18401A	233	2400M	040	2774PS	051
16644A-P	230	18401M	233	2400MZ	023	2774PS-3/8	082
16655A	230	18405A	233	2400W-BA	041	2780	054
16666AL	230	18405M	233	2405A	040	2785	054
16688A	230	18405M(D)	234	2405M	040	280PM	285
166P	172	18410M	234	2410M	041	3000(PH)	070
166PS/6	172	186	168	2415A	041	3000(PZ)	070
166S	172	18760	240	2415M	041	3005	070
16760	229	18770	241	2425	042	3010A	071
16770	230	18771	241	24300A	270	3010M	071
16771	230	18866A	241	24300M	270	3010MZ	030
167A	170	18877A	241	24305M	270	3011M	073
167C(2B)	170	18888AL	241	2430M	046	3012A	072
167C/3-2B	170	19300M	247	2430T	046	3012M	072, 279
167M	170	19400A	246	24310M	270	3015M	073
168C	173	19400M	246	24400A	269	3020	074
168CS	173	19760	247	24400M	269	3025(IP)	077
168H-B	171	19770	247	24405M	269	3025(IPR)	078
168P	173	19977A	247	2440A	045	3025(T)	075
168P(PZ)	171	2000(PH)	046	2440M	045	3025(TH)	076
168PS/6	173	2000(PZ)	046	2440T	045	3025-100R(T)	075
168S	173	2000Z	024	24410M	269	3025-100R(TH)	076
168T(250)	282	2005	046	2441M	045	3025-50-T35	075
168T(IP)	308	2005Z	024	24425	269	3025Z	030
168T(TH)	171	2010A	047	2445A	045	3027	078
168T/7(TH)	171	2010M	047	2445M	045	3110A	079, 278
169	282	2010MZ	024	2450MS	042	3110M	079, 278
169/2	282	2011M	047	24760-P	270	3112G	154
169BP	282	2020	047	2715	152	3112RK	307
169HR	282	2025(IP)	049	2725RK	308	3116M	150
169HR/2	282	2025(IPR)	049	2725RK-3/8	308	3117M	069
169WM	282	2025(T)	048	2725Z	025	3119	079, 301
170S	303	2025(TH)	048	2725Z-3/8	031	3127	139
171	303	2025Z	025	2725Z-3/8(L160)	031	3128(L80)	139
17108	244	2120	052	2726Z	025	3129	141
17108-32	244	2127	139	2726Z-3/8	031	3131A	138
171B-1/2	303	2137	049, 157	2726Z-3/8(L160)	031	3131E	138
171S	303	2138	049, 159	2749P-1/4HF	157	3132	138
171SB-1/2	303	22300A	266	2749P-3/8	080	3137	079, 157
172	303	22300M	266	2749P-5/16HF	159	3138	079, 159
17300A	243	2233A	054	2749PS-3/8	080	3201AMW	089, 296
17300M	243	22400M	266	2749RK	306	3206AM	089
17400A	242	22425	266	2749RK-3/8	306	3210A	089
17400M	242	2251A	055	2753BRK	306	3210M	089
17405A	243	2251M	055	2753J	050	3216	090
17405M	243	2254M	147	2753JB	050	3217M	090
17760	245	2258M	055	2753N	050	3225A	274
17770	245	2259M	056	2753NB	050	3247	076, 281
17788A	245	2263A	056, 296	2753P	050	3250M	090
17799A	245	2275	056	2753PB	050	3251	091
178	275	2276	056	2753PS	050	3252M	091
180M	157	2277	056	2753RK	306	3264	138
18101M	289	2285ZE	027	2755	051	3275	091
18102M	290	2286Z	027	2755RK	307	3277	091

Numerical Index

3278	091	3749S	080	4101	107, 283	4440A	100
3285Z	034	3749S-1/2	108	4102	279	4440M	100
3285ZA	034	3749SB	080	4103M	137	4440T	100
3285ZE	034	3749SB-1/2	108	4104	136	4445A	100
3286Z	034	3749SBRK-1/2	306	4109M	278	4445M	100
3300A	063	3749SRK-1/2	306	4110A	107, 278	4450M	096
3300C	272, 273	3751J	274	4110M	107, 278	4466A	115
3300CB	272	3751N	274	4111M	278	4711X	153, 284
3300CZ	029	3752J	081	4112G	154	4711XZ	035
3300FN	065, 276	3752N	081	4112N	154	4715	153
3300M	063	3752RK	307	4112RK	307	4715S	153
3300M(L120)	066	3753BRK	306	4117M	099	4715SL	153
3300M/4-L120	066, 281	3753J	081	4122	276	4725RK	308
3300MZ	029	3753JB	082	4127	140	4725Z	035
3300P	272	3753N	081	4128(L120)	140	4747	115
3300S	272	3753NB	082	4129	141	4749J	111
3300W	064	3753P	081	4131A	138	4749N	111
3300X	062	3753PB	082	4132	138	4749RK	306
3300XA	062	3753RK	306	4133	276	4750BRK	306
3300XZ	028	3753SM	080	4137	107, 157	4750J	109
3305A	063	3753SMB	080	4138	107, 159	4750JB	109
3305M	063	3755	085	4202	279	4750N	109
3305M(L120)	066	3755RK	307	4203M	137	4750NB	109
3305M/4-L120	066	3756	085	4203MF	137	4750P	109
3305P	272, 273, 295	3756Z	033	4211A	134	4750PB	109
3305PZ	029	3756Z-1/2	033	4211M	134	4750RK	306
3305W	064	3756ZS	033	4214M	134	4752J	108
3305X	062	3757	085	4223M	116	4752N	108
3305XA	062	3760	086	4238AM	116, 296	4752RK	307
3310M	064	3760Z	032	4241A	117	4753BRK	306
3322A	088	3762	085	4241M	117	4753J	110
3322AZ	033	3763	086	4249M	117	4753JB	110
3325	065	3768J	087	4250M	117	4753N	110
3340C	273	3768P	087	4251A	118, 296	4753NB	110
3340M	068	3768RK	309	4251M	118	4753P	110, 111
3341G	275	3768Z	032	4252M	118	4753PB	110
3342G	275	3768ZRK	309	4254	118	4753RK	306
3344A	088	3769H	087	4262M	118	4755	112
3345P	273	3769N	087, 174	4272AM	119	4755RK	307
3350M	065	3769NWF	087, 174	4275	119	4756	112
3350M(L120)	066	3770	088	4276	119	4756Z	036
3350M/2-L120	066, 281	3771	088	4277	119	4760	113
3350X	062	3771Z	033	4282	280	4760Z	036
3400A	058	3772Z	033	4285Z	036	4763	113
3400LH	060	3774J	083	4285ZE	036	4768J	112
3400M	058, 279	3774JB	083	4300A	097	4768P	112
3400MZ	028	3774JBL	084	4300C	272	4768RK	309
3400W	059	3774JL	083	4300H	277	4768Z	035
3405A	058	3774N	083	4300H(8P)	277	4768ZRK	309
3405M	058	3774NB	083	4300M	097	4770	114
3405W	059	3774NL	083	4300M(L110)	284	4771	114
3410M	059	3774P	083	4300M(L120)	099	4771Z	036
3415A	060	3774PB	083	4300M(L60)	284	4772Z	036
3415M	060	3774PL	083	4300PMZ	035	4774J	111
3425	060	3774PS	082	4300S	272	4774JB	112
3425(2B)	061	3774P-SR	084	4305A	097	4774N	111
3430M	069	3776J	084	4305M	097	4774NB	112
3440A	067	3776N	084	4310M	098	4774P	111
3440M	067	3776P	084	4325	098	4774PB	112
3440T	068	3780	088	4325(L140)	099	4780	114
3441M	068	3785	088	4325(L140)-2B	099	4781N	114
3445A	067	4000(PH)	100	4340C	273	4785	114
3445M	067	4000(PZ)	100	4400A	093	4788	115
3445W	067	4005	100	4400LH	096	6012M	121
3450M	061	4010A	101	4400M	092	6100M	135
3450MH	061	4010M	101	4400M(DU)	294	6100MRK	309
3701	274	4010M(12P)	277	4400MZ	035	6101	121, 283
3715	152	4012A	103	4400W	094	6102M	290
3715S	152	4012M	102, 294	4401M	092	6112	154
3715SL	152	4020	104	4405A	093	6112RK	307
3715SLK	152	4020(MH)	278	4405M	092	6201A	125
3716	152	4025(IP)	106	4405M(DU)	294	6201M	125
3725RK	308	4025(T)	105	4405W	094	6212M	125
3725Z	031	4025-60-T35	105	4406M	092	6300A	121
3725ZS	031	4027	106	4410M	094	6300M	121
3726Z	032	4100A	134	4425	095	6305A	121
3726ZS	032	4100ARK	309	4425(EPL)	095	6305M	121
3749BRK	306	4100M	134	4425-N	094, 283	6400A	120
3749RK	306	4100MRK	309	4433A	115	6400M	120

6405A	120	CLIP.P/5	034	RS2025/7-IP	049	RS3400MZ/12	028
6405A(MV)	294	C-Ring	256	RS2025/7-IPR	049	RS3400MZ/8	028
6405M	120	C-RingSet	256	RS2025Z/7	025	RS3400W/7	059
6425	120	D3753J	081	RS20XXZ/9	024	RS3405A/9	058
6644A	124	D4753J	110	RS2127/10	139	RS3405M/12	058
6688A	124	ENH2003	055	RS2127/6	139	RS3405W/7	059
6749	122	ESH2001	055	RS2300A/9	043	RS3410M/12	059
6749-HEAD	122	ESH3001	089	RS2300M/12	043	RS3425/4(2B)	061
6749RK	306	ETH3001	089	RS2300MZ/12	023	RS3425/9	060
6752	122	HA001	302	RS2300X/12	042	RS3430M/6	069
6752-HEAD	122	HA003	302	RS2300XZ/9	023	RS3440A/8	067
6752RK	307	NV13134	253	RS2305A/9	043	RS3440M/8	067
6755	123	NV13145	251	RS2305M/12	043	RS3440T/8	068
6755RK	307	NV13400	251	RS2310M/12	044	RS3441M/5	068
6760	123	NV13760-P	251	RS2350M/4	044	RS3445W/7	067
6768	123	NV14134	253	RS2350X/4	042	RS3450M/8	061
6768-HEAD	123	NV14145	254	RS2400A/9	040	RS3450MH/6	061
6768RK	309	NV14400	254	RS2400M/12	040	RS3X00MZ/12	029
6770	124	NV14433A-P	254	RS2400MZ/12	023	RS4010A/10	101
6785	124	NV14760-P	254	RS2400W/9-BA	041	RS4010M/10	101
6788	124	NV16400	255	RS2405A/9	040	RS4012A/10	103
8012M	127	NV16760	255	RS2405M/12	040	RS4012M/10	102
8102M	290	O-Ring	257	RS2410M/12	041	RS4020/6	104
8225M	130	P2201AM	057	RS2425/6	042	RS4025/9	105
8400A	126	P2251M	057	RS2445A/9	045	RS4025/9-IP	106
8400M	126	P2258M	057	RS2450MS/6	042	RS4027/7	106
8405A	126	P2285Z	027	RS3010A/8	071	RS4127/6	140
8405M	126	Pin	257	RS3010M/8	071	RS4129/5	141
8749	128	PIPE	122, 123, 128	RS3010MZ/8	030	RS4300A/10	097
8749-HEAD	128	PK166PS/6	172	RS3012A/8	072	RS4300M/10	097
8749RK	306	PK168PS/6	173	RS3012M/8	072	RS4300M/12	097
8760	127	PK2346/6	088	RS3015M/8	073	RS4305A/10	097
8768	128	PK2760/6	052	RS3020/6	074	RS4305M/10	097
8768-HEAD	128	PK2763/6	052	RS3020/7	074	RS4310M/10	098
8768RK	309	PK3760/6	086	RS3025/8	075	RS4325/7	098
8770	127	PK3763/6	086	RS3025/8-IP	077	RS4400A/10	093
8785	128	PK4760/5	113	RS3025/8-L100R	075	RS4400LH/6	096
8788	128	PK4763/5	113	RS3025/8-L100RH	076	RS4400MZ/10	035
8866A	127	PS6	291	RS3025/9-HOLE	076	RS4400W/8	094
AG112A	155	PS8	291	RS3025/9-IPR	078	RS4401M/10	092
AG112F	155	Puller	256	RS3025Z/8	030	RS4405A/10	093
AG112H	155	PW6P	291	RS3027/5	078	RS4405W/8	094
AG318A	155	PW8L	291	RS3127/8	139	RS4406M/10	092
AN112A	155	PW8P	291	RS3129/6	141	RS4410M/10	094
AN112C	155	PW8P/4	291	RS3300A/9	063	RS4425/6-EPL	095
AN14300	286	R810	145	RS3300FN/8	065, 276	RS4425/6-N	094, 283
AS2305A	043	R810A	148	RS3300M/12	063	RS4425/7	095
AS2405A	040	R810B	148	RS3300MZ/12	029	RS4450M/10	096
AS2445A	045	R810C	148	RS3300MZ/8	029	RSAL	034
BD004	301	R810D	148	RS3300W/7	064	RSAL200	034
BD008E	299	R810E	148	RS3300X/8	062	RSAL300	034
BD011SE	299	RS13012M/8	192	RS3300XA/9	062	RSAS2305A/10	043
BD014E	298	RS13025/8	192	RS3300XZ/12	028	RSAS2405A/10	040
BD014E-140	298	RS13301X/9	186	RS3300XZ/8	028	RSX025/11-IP	077
BD014E-SF	299	RS13401M/9	183	RS3305A/9	063	RSX025/11-IPR	078
BD014SE	298	RS13401MS/11	183	RS3305M/12	063	RSX425/14	060
BD014XE-SF	299	RS14012M/10	209	RS3305W/7	064	S3240A	090
BD016E	300	RS14025/6	209	RS3305X/8	062	S3240M	090
BD016JE	300	RS14124/7	287	RS3305XA/9	062	S4240A	116
BD017E	300	RS14301X/10	203	RS3310M/12	064	S4240M	116
BD018	301	RS14401M/10	200	RS3325/9	065	SP4122	276
BD022-120P	302	RS14401MS/10	201	RS3340M/8	068	SP4300M	276
BD023E	302	RS14405M/11	199	RS3350M/5	065	SP4305M	276
BD024E	302	RS2010A/8	047	RS3350X/4	062	ST4027-140	277
BD042E	298	RS2010M/7	047	RS3400A/9	058	TI4261M	132
BD14400MJ	300	RS2025/7	048	RS3400LH/7	060		
BIT-60E	298	RS2025/7-HOLE	048	RS3400M/12	058		

Reproduction in whole or in part without proper and prior authorization is prohibited.
Der Nachdruck, im ganzen oder auch auszugsweise, bedarf unserer ausdrücklichen,
vorherigen Genehmigung.

La reproduction de ce catalogue en tout ou en partie sans autorisation préalable est
interdite.

本商品目錄之全部版權,係歸於株式會社山下工業研究所(KOKEN TOOL CO.,LTD.)所有,不論其部分或
全部,未經本公司許可,均不得複製

