

Koken®



Koken TOOL CO., LTD.





INDEX

Z-series

P021 - 036



Z-SERIES

Hand Sockets

P037 - 138



HAND MANUALES

Titanium Sockets

P139 - 140



TITANIUM DE TITANIO

Accessories

P141 - 176



ACCESORIES ACCESORIOS

Screwdrivers

P177 - 182



SCREWDRIVERS DESTORNILLADORES

Impact Sockets

P183 - 246



IMPACT DE IMPACTO

Sleeve Drive Sockets

P247 - 253



SLEEVE-DRIVE

Industrial Sockets

P257 - 262



INDUSTRIAL INDUSTRIALES

Protector Sockets

P263 - 266



PROTECTOR PROTECTORES

Automotive Tools

P267 - 290



AUTOMOTIVE

Construction

P291 - 301



CONSTRUCTION CONSTRUCCION

Renewal Kits

P303 - 307



RENEWAL KITS JUEGOS DE PIEZAS REPUESTO

Pictograms Socket openings / Bit shape					
	FLAT DRIVE® (6-point)		TORX® (E)		TORX® (T)
	FLAT DRIVE® (12-point)		NUT GRIP® / TORX® (E)		Tamper-Resistant TORX® (TH)
	NUT GRIP®		TORXplus® (EP)		TORXplus® (IP)
	Surface Drive		LH-STIX® (LH-S)		Tamper-Resistant TORXplus® (IPR)
	PATHFINDER®		Bit Holder		Triple-Square(XZN)
	Flare Nut		Phillips		Triple-Square with Hole(XZN)
	Square		Slotted		Ribe-CV
	Double Square		Hexagon		POLYDRIVE
	Stud Bolt Puller		PZ		Double-Hexagon
	NUTTWISTER®		Square Male		Socket Set on Rail

Pictograms Mechanics / Specification					
	S.O.D.H-System®		Thin-Walled		1/4"(6.35mm) Sq. Dr.
	S.O.D.H-System® (4750 series)		with Magnet		3/8"(9.5mm) Sq. Dr.
	Two-Step Dog		20 tooth Gear		1/2"(12.7mm) Sq. Dr.
	Three-Step Dog		24 tooth Gear		5/8"(16.9mm) Sq. Dr.
	Quick Release Button		30 tooth Gear		3/4"(19.0mm) Sq. Dr.
	Flexible Head		36 tooth Gear		1"(25.4mm) Sq. Dr.
	Swivel Head		44 tooth Gear		1.1/2"(38.1mm) Sq. Dr.
	L/R Marking		45 tooth Gear		2.1/2"(63.5mm) Sq. Dr.
	Oval Shape Shank		60 tooth Gear		3.1/2"(88.9mm) Sq. Dr.
	Wobble-Fix				Caution



Reproduction in whole or in part without proper and prior authorization is prohibited.
 Se prohíbe la reproducción total o parcial sin la debida autorización previa.

Specifications or design of any product in this catalogue are subject to change without notice.
 Las especificaciones o el diseño de cualquiera de los productos de este catálogo están sujetos a cambio sin previo aviso.



■ TEST AND LABORATORY

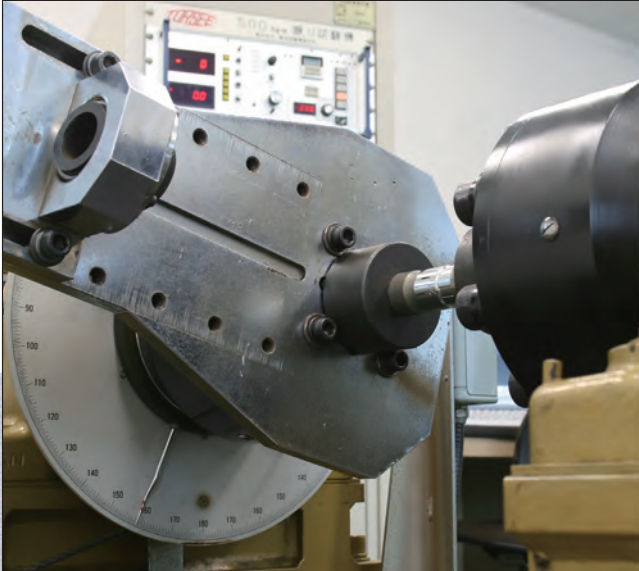

Ko-ken uses a variety of test equipment. Strength is measured by the Static Load Test Machine that can measure torque load up to 5,000Nm. Durability is measured by the Cyclic Test Machine and corrosion resistance testing is done by the Salt Spray Test Machine. The test results are used to improve our standard products and assist with new product design and development.



■ DESIGN AND DEVELOPMENT

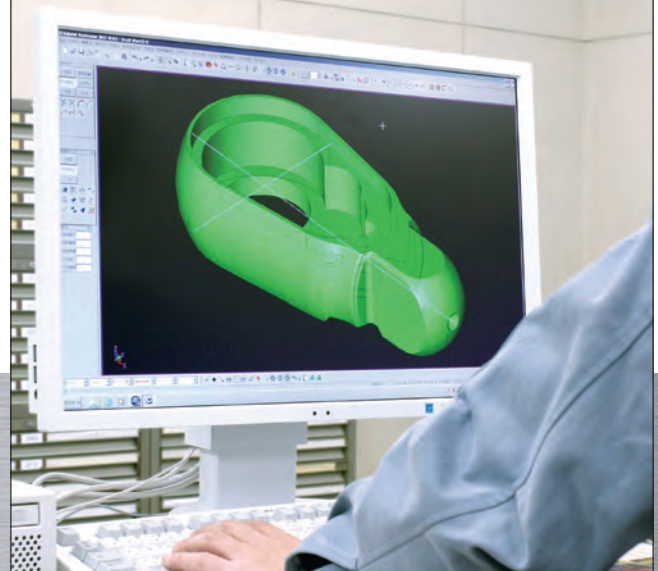

The 3D-CAD is used to improve standard products, designing new products and making customized items for special requirements. Trial products are regularly developed, manufactured and tested to improve the durability, appearance and functionality of all tools produced by Ko-ken.



■ FORGING



The Forging machines are used for the forging process. These machines can produce mass quantities of sockets and parts with high accuracy that ordinary drop forging machines can not achieve. On the other hand, ordinary forging machines are also used for small production runs.



■ TURNING



The forged steel is turned into required shapes and dimensions. The MC (Machining Center) operates with extraordinary speed and precision. The article number, size, logo, production number, and MADE IN JAPAN are marked on the products after the turning process has been completed.



■ HEAT TREATMENT



To make the tools stronger and more durable, proper heat treatment is critically important. The temperature and the time of the heat treatment are strictly regulated by a very accurate control device.



■ INSPECTION

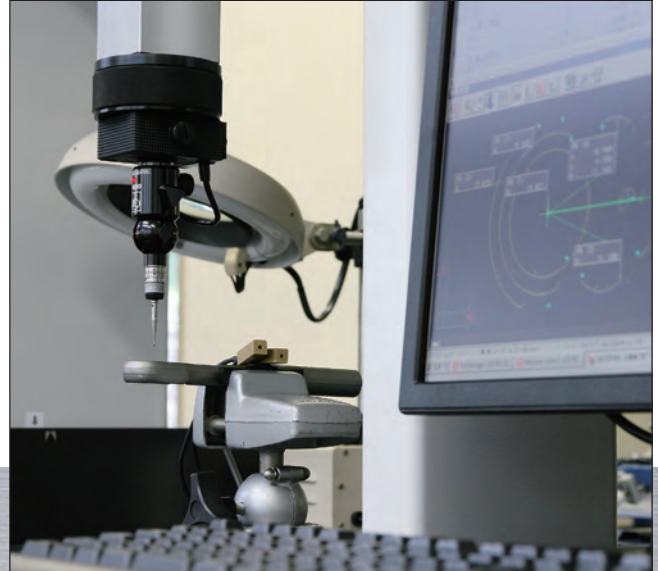

Our products are periodically checked at each production process by inspection devices. Highly accurate 3-D measuring instruments are used to inspect and check dimensions.





FLAT DRIVE®

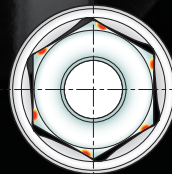

Flat Drive is designed to guarantee a flat surface contact between the socket and the bolt/nut. The Flat contact reduces wear and allows to transmit a higher torque value. The Flat Drive System is also used for the square drive end as well as the hexagonal or bi-hexagonal openings of the socket.

El diseño de Contacto Plano garantiza una superficie de contacto plana entre el vaso y el perno/tuerca. El contacto plano reduce el desgaste y permite transmitir un par mayor. El Sistema de Contacto Plano se utiliza tanto para el extremo del cuadrado conductor como para la boca hexagonal o bi-hexagonal del vaso.

SOCKETS



SURFACE DRIVE



SURFACE DRIVE



Surface drive sockets are designed to retain contact with flat sides of nut to transmit high torque and reduce nut wear.

These sockets are ideal for use on polished nuts, aluminum nuts and nuts with worn out points.

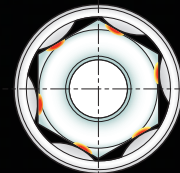

Los vasos de contacto curvo se diseñan para mantener el contacto con las caras planas de la tuerca y transmitir un alto par reduciendo el desgaste de la tuerca.

Estos vasos son ideales para utilizarse en tuercas pulidas, tuercas de aluminio y tuercas con puntas desgastadas.

NUT GRIP®



NUT GRIP®



Twin balls at the 6-point opening hold bolt/nut tightly for safe and reliable work.

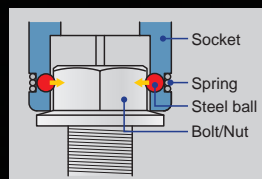

El perno/tuerca se sujeta firmemente por medio de dos bolas en la boca hexagonal para un trabajo seguro y fiable.

PATHFINDER®



PATHFINDER®



The beveled flats of the 6-point opening of the PATHFINDER socket engage the nut almost immediately. PATHFINDER sockets are ideal for use with power tools in automatic assembly processes, as the power tool does not have to be totally stopped for the socket to engage the nut.

Las caras biseladas de la boca hexagonal del vaso GUÍA acoplan el vaso inmediatamente.

Los vasos GUÍA son ideales para su utilización con herramientas mecánicas en procesos de montaje automáticos, ya que no es necesario que la herramienta esté completamente parada para acoplar el vaso a la tuerca.





RATCHET HANDLE



S.O.D.H-System®

Two dogs are located in the ratchet body so that the dogs and springs are held securely in place while allowing the reversing lever and dog to switch smoothly.

The torque load on the gear it is transmitted vertically to the dog, and in turn, down the ratchet handle. This mechanism locks gears tightly in place while torque is being applied, thus avoiding any gear slippage.

Los dos trinquetes del cuerpo de la llave de carraca y sus muelles están dispuestos en el cuerpo de la llave de forma que se mantienen firmemente en posición permitiendo un cambio suave de la palanca de inversión y del trinquete.

El par sobre la rueda dentada se transmite verticalmente al trinquete, y al mismo tiempo al mango de la llave de carraca. Este mecanismo bloquea firmemente los dientes mientras se aplica el par, evitando así el deslizamiento de los mismos.



Two-Step Dog

Two flats hold two teeth of the ratchet gear, thus increasing the maximum torque load of the ratchet compared with a single-step system.

Los dientes de la rueda de la llave de carraca se inmovilizan por medio de dos dientes aumentando de esta forma el par máximo de la llave en comparación con el sistema de un paso.



Three-Step Dog

Two dogs are set in the same axis, and the three teeth hold the ratchet gear.

The enlarged contact area produces about 10% higher torque value and the S.O.D.H-System provides smooth and light movements.

Se disponen dos trinquetes en el mismo eje y la rueda de la llave de carraca se bloquea por medio de tres dientes.

El aumento de la superficie de contacto produce un aumento de par de aproximadamente 10% y el sistema S.O.D.H permite movimientos suaves y sin esfuerzo.



SHAPE of HANDLE



OVAL SHAPE SHANK



Unique designed oval shape shank provides extra strength and durability.

El particular diseño de caña de sección Ovalada proporciona más resistencia y duración.

KNURLING

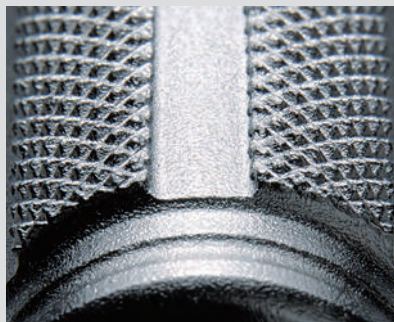

Ratchets and Hinge handles have knurling on the grip to ensure the tool can be held securely.

Extension bars also have 6-point knurling on the outside of the female square drive. This gives a grip to hold with your fingers as well as preventing the tool from rolling on flat surfaces.



WOBBLE-FIX



One use as a flexible extension bar permitting movement up to 15° angle and the other as a normal extension bar.

Una, como alargadera flexible que permite trabajar con un ángulo de 15°, otra, como alargadera normal.

Fix

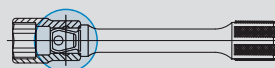

Wobble

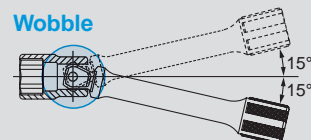



STUD BOLT PULLER/SETTER

STUD BOLT PULLER



The body design was changed to hexagonal shape to minimize tolerances. This shape is also effective to lessen excessive load on cages and rollers inside the body.



RATCHET PULLER



Puller for tightening stud bolts. Go-through body allows puller to grip the stud bolt at any position along the stud.

Three-roller protects the bolt from damage.



STUD BOLT PULLER



STUD BOLT SETTER

Special socket for installing a stud bolt. The bolt contacts with a steel ball to prevent the bolt from sticking onto the socket. After installing the bolt, turn anti-clockwise to remove the socket.

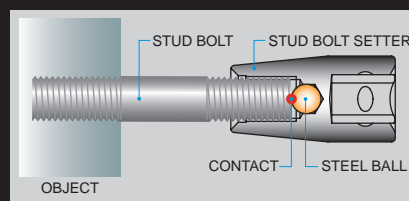

STUD BOLT SETTER



ATTACK DRIVER®

1 BLACK FINISHED HEAD

The top of Attack Driver is manganese phosphate treated to prevent chrome peeling off the head when it is struck.

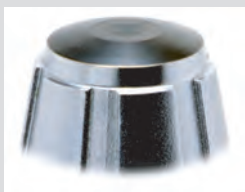

2 BODY SHAPE

Original body shape allows stronger grip. It makes it easier to convert the striking power into twisting power.



ATTACK DRIVER®



1 3 HEAT TREATMENT FOR ANTI-CRACK

Special Heat treatment is applied on the parts of Attack Driver. Hardness of Striking head is slightly softer to prevent cracking. The cam part has higher hardness to improve anti-wear.

3 SPRING

Strong spring is used to convert the striking power efficiently into twisting power.





FREE-TURN GRIP



FREE-TURN
CROSS WRENCH



SPINNING CROSS WRENCH

The shaft of cross wrench turns freely within the knurled grip. The cross bar is removable for easy storage in a compact space.



FLEXIBLE SPEEDER

Free-turn grip allows speedy removal or replacement of wheel nuts. It can also be used as a hinge handle to tighten or loosen the nuts.



SPINNING SLIDE T-HANDLE

The knurled grip is attached in the middle of shaft for free turning. Oval shaped cross bar prevents the bar from turning inside the shaft during use.



IMPACT WHEEL NUT SOCKET



WHEEL NUT SOCKET

PLASTIC PROTECTOR

A detachable plastic protector is fitted to the socket to prevent damage to the wheel when working in tight areas.

The socket size and Ko-ken Mark printed on the shaft makes it easier to see if the socket is still rotating or stopped.

EXTRA THIN-WALLED



Thin-walled shape and 110mm length gives extra reach for nuts recessed deep inside the wheel.

They are ideal for aluminum wheel nuts where access to nut is very tight. Colour coded shafts make size identification easy.

SPARK PLUG SOCKET



SPARK PLUG SOCKET

CLIP TYPE

It is designed to grip a spark plug securely at its hexagonal part by two stainless spring clips.

Internal brass guide holds the clips in place ensuring perfect alignment of the spark plug into the threaded plughole of the cylinder head and thus preventing thread damage.

The brass guide also eliminates stress loading and possible damage to the ceramic insulator.

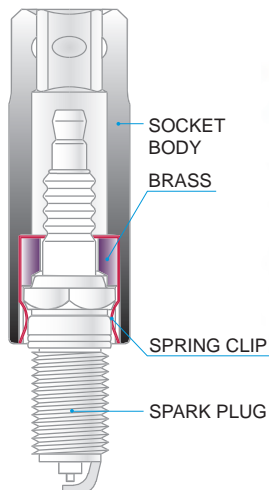

UNIVERSAL JOINT

Hexahedral engagement achieved with compact design

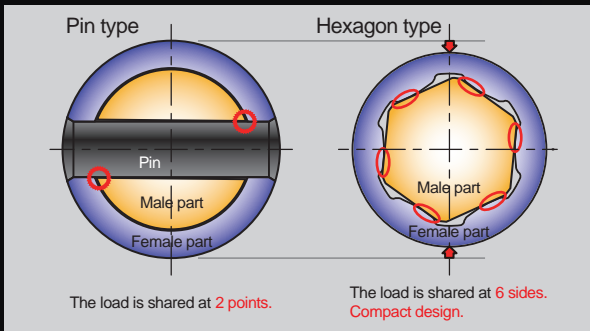

Ball type universal joints use a new structure of joint mechanism without a pin. Being connected by mutually engaged hexahedrons, the load is dispersed across the whole outer circumference. High durability is obtained with this innovative, compact design.



LOCKING ADAPTOR



Impact sockets can be attached or detached on the LOCKING ADAPTOR for safety just by sliding the holder rather than using a pin and an O-ring. It can reduce the time to change a socket, especially when you need to use a variety of socket sizes.

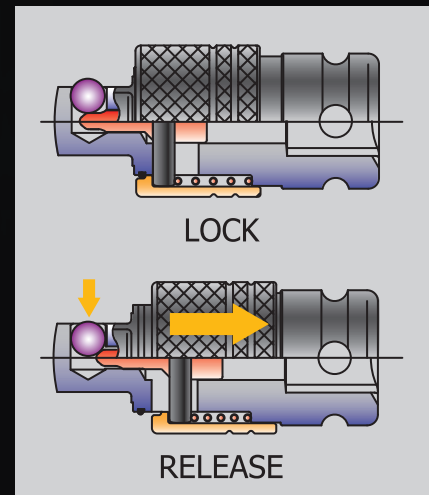



NUTTWISTER®



The NUTTWISTER's six teeth have a special helical structure that tapers inward, locking onto the rounded-off bolt or nut for removal. NUTTWISTER can be applied to any round bolts like stud bolts, cap bolts, provided the correct size is used and the bolt or nut is unbroken.

BOLTTWISTER®



Use the BOLTTWISTER to remove a broken bolt whose head has come off. After drilling a hole in the center of the broken bolt, insert BOLTTWISTER into the hole and turn it counterclockwise until it sticks. The bolt can be removed by continuing to turn it.

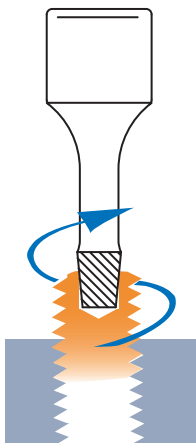

License

TORX® / TORXplus® & LHSTIX®

TORX® / TORXplus® and **LHSTIX®** are recognized as three of the most efficient fastening systems because of their ability to transfer greater torque, reduce end load and virtually eliminate tool slippage.

TORX® / TORXplus® y **LHSTIX®** están reconocidos como los tres sistemas más efectivos de fijación debido a su mayor capacidad de transmitir par, reducir el par final y eliminar completamente el deslizamiento de la herramienta.

TORX® & TORXPLUS®

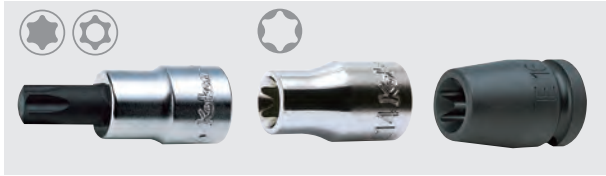
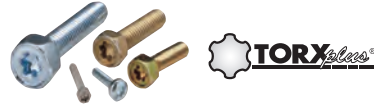

TORX® and **TORXplus®** are registered trademark of **Acument Intellectual Properties, LLC**. **Koken TOOL CO., LTD.** holds the official license to use the trademark **TORX®** and **TORXplus®**.
TORX® y **TORXplus®** es una marca registrada de **Acument Intellectual Properties, LLC**. **Koken TOOL CO., LTD.** cuenta con licencias oficiales para el uso de la marca **TORX®** y **TORXplus®**.

LHSTIX®



Line Head Straight
LH-S series



LHSTIX® is a registered trademark of **OSG CORPORATION** System Engineering Department. **Koken TOOL CO., LTD.** holds the official license to use the trademark **LHSTIX®**.
LHSTIX® es una marca registrada de **OSG CORPORATION** System Engineering Department. **Koken TOOL CO., LTD.** cuenta con licencia oficial para uso de la marca **LHSTIX®**.

Registered Trademarks

Koken®



Koken TOOL CO., LTD.®

HIGH PERFORMANCE TOOLS OF CONVINCING QUALITY

山下工業研究所®

山下工研®

S.O.D.H-System®

Flatdrive®

ATTACK DRIVER®

HANDY-ENDY®

PATHFINDER®

Nut Grip®

LOCK NUT BUSTER®

NUTTWISTER®

BOLT TWISTER®

Aerial Photograph



Warranty

WARRANTY

The trade mark **Koken** is your unqualified warranty against any defect in material or workmanship. Each **Koken** tool is built to more than meet the requirements of its intended use and is carefully checked before leaving the factory. Any **Koken** tool which fails because of defective material or workmanship will be repaired or replaced through your **Koken** dealer, to the exclusion of any further liability.

GARANTIA

La marca **Koken** es la garantía incondicional contra cualquier defecto de materiales o de fabricación. Todas las herramientas **Koken** están fabricadas para satisfacer con creces las exigencias del uso previsto y se inspeccionan meticulosamente antes de su expedición. Las herramientas **Koken** que fallen por defectos de materiales o de fabricación se repararán o reemplazarán a través del distribuidor **Koken** correspondiente, excluyendo cualquier otra responsabilidad.

ISO9001







SAFETY
ADVISER



GENERAL / CONSIDERACIONES GENERALES

- (a) Make sure you use the right type socket, whose opening fit the nut.
Asegurarse de utilizar el tipo de vaso adecuado, con una boca que se ajuste a la tuerca.
- (b) For use on electric or air IMPACT Wrenches select IMPACT Sockets only.
Con llaves mecánicas de IMPACTO, utilizar solamente Vasos de IMPACTO.
- (c) When using nut runners or IMPACT Wrenches wear safety goggles.
Cuando se utilicen aprieta-tuercas mecánicos o llaves de IMPACTO, llevar siempre gafas de seguridad.
- (d) Plastic or rubber handles are not intended to act as insulation.
Los mangos de goma o de plástico no están previstos para aislamiento
- (e) Never substitute a HAND Socket for an INDUSTRIAL Socket or an IMPACT Socket, or an INDUSTRIAL Socket for an IMPACT Socket.
No sustituir nunca un vaso INDUSTRIALES o un vaso de IMPACTO por un vaso MANUAL, ni un vaso de IMPACTO por un vaso INDUSTRIALES.
- (f) Items in this catalogue marked  can be loaded to torque values which may cause breakage. In the interest of your own safety always apply load evenly and progressively to avoid breakage and possible injury.
Los artículos de este catálogo marcados  se pueden forzar con pares que pueden causar rotura. En interés de su propia seguridad aplicar siempre el par uniforme y progresivamente para evitar la rotura y posibles lesiones.

SOCKETS / VASOS

Sockets showing cracked walls, battered points or other marks of wear are to be replaced.

Los vasos que presenten paredes agrietadas, cantos machacados u otros signos de desgaste deben reemplazarse.

HANDLES / MANGOS

A ratchet is not a hammer
Una llave de carraca no es un martillo.

Never use loose pipes or other improvised attachments on handles for increased leverage.

No utilizar nunca tubos sueltos u otras herramientas improvisadas con los mangos para aumentar el brazo de palanca.

EXTENSION BARS / ALARGADERAS

The combination of several short extensions instead of one correct sized one is to be avoided.

Debe evitarse combinar varias alargaderas cortas en lugar de una sola alargadera de longitud correcta.

ADAPTORS / ADAPTADORES

Adaptors are to be used reasonably. Be reminded that high torque potentials are reached when using a "down" adaptor, a bigger sized handle to a smaller drive socket. Always stay within safe limits.

Los adaptadores se deben utilizar razonablemente. Debe tenerse en cuenta que al utilizar adaptadores "para menor diámetro", mayor mango en un vaso conductor más pequeño, se consiguen pares superiores al necesario. Mantenerse siempre dentro de límites seguros.

Koken

Z-series



Z-Series : Feature

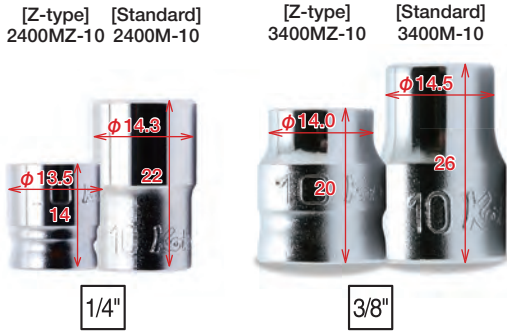

COMPACT

2400MZ, 3400MZ and 4400MZ are designed 5-14mm shorter than standard 2400M, 3400M and 4400M. Ideal for working in confined and tight areas.

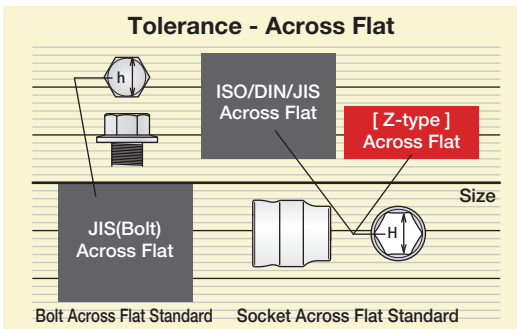

TOLERANCE-Hexagon Opening

Ko-ken standard sockets are manufactured according to DIN/ISO standards. The tolerances of Z-Series sockets are precisely controlled to achieve a more positive fit between bolt and socket.

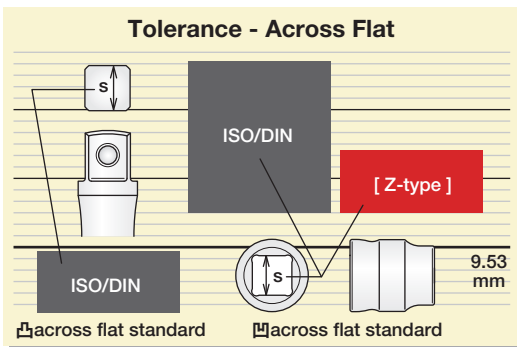

TOLERANCE-Square Drive

Manufacturing tolerance of Male and Female Square are precisely controlled to achieve a more secure fit between Socket and Handle.

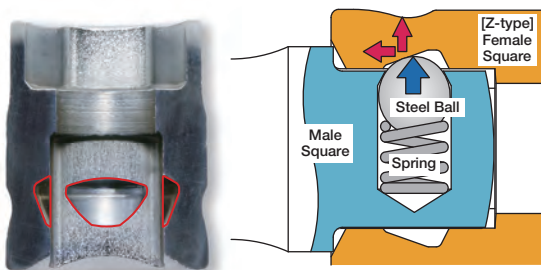

BALL HOLDING GROOVE

Original Ball Holding system is applied on Z-series. This mechanism gives secure connection between Socket and Handle.

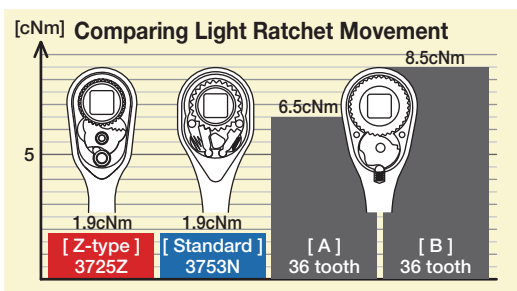

RATCHET HANDLE

Smaller head with 36 tooth gear and light ratchet movement allow working in narrow space and confined areas.

Specifications or design of any product in this catalogue are subject to change without notice.

Las especificaciones o el diseño de cualquiera de los productos de este catálogo están sujetos a cambio sin previo aviso.

* A, B : Other Brand

2400MZ (mm)	D ₁ (mm)	D ₂ (mm)	H (mm)	L (mm)	(g)	(pcs.)
4	6.4	11	3	14	6	10
4.5	7	11	3	14	6	10
5	7.6	11	3	14	6	10
5.5	8.2	11	3.5	14	6	10
6	8.8	11	3.5	14	6	10
7	9.9	11	3.5	14	6	10
8	11.1	11.7	4.5	15	7	10
10	13.5	12.5	7	15	8	10
11	14.7	13.2	7	15	9	10
12	15.9	14.4	7	15	11	10
13	17.1	15.6	7	15	14	10
14	18.3	16.8	7	15	16	10

RS2400MZ/12	12 Pieces Set/Rail 200mm	(g)
4, 4.5, 5, 5.5, 6, 7, 8, 10, 11, 12, 13, 14		228

2300XZ (mm)	D ₁ (mm)	D ₂ (mm)	H ₁ (mm)	H ₂ (mm)	L (mm)	(g)	(pcs.)
5.5	8.2	11	6	20	30	10	10
6	8.8	11	7	20	30	10	10
7	9.9	11	8	20	30	11	10
8	11.1	11.7	9	20	30	13	10
10	13.5	12.5	11	20	30	16	10
11	14.7	13.2	12	20	30	19	10
12	15.9	14.4	13	20	30	22	10
13	17.1	15.6	14	20	30	26	10
14	18.3	16.8	14	20	30	30	10

RS2300XZ/9	9 Pieces Set/Rail 200mm	(g)
5.5, 6, 7, 8, 10, 11, 12, 13, 14		290

2300MZ (mm)	D ₁ (mm)	D ₂ (mm)	H ₁ (mm)	H ₂ (mm)	L (mm)	(g)	(pcs.)
4	6.4	11	5	41	50	14	10
4.5	7	11	5.5	41	50	16	10
5	7.6	11	6	41	50	16	10
5.5	8.2	11	6.5	41	50	16	10
6	8.8	11	7	41	50	17	10
7	9.9	11	8	41	50	20	10
8	11.1	11.7	9	41	50	22	10
10	13.5	12.5	11	41	50	29	10
11	14.7	13.2	12	41	50	33	10
12	15.9	14.4	13	41	50	40	10
13	17.1	15.6	14	41	50	45	10
14	18.3	16.8	16	41	50	51	10

RS2300MZ/12	12 Pieces Set/Rail 200mm	(g)
4, 4.5, 5, 5.5, 6, 7, 8, 10, 11, 12, 13, 14		445

2400MZ 6-point Sockets Vasos Hexagonales

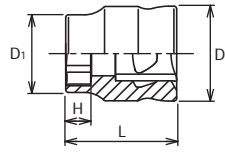

RS2400MZ/12 Socket Set on Rail Juego de Vasos en Regleta



2300XZ 6-point Sockets, Semi-Deep Vasos Hexagonales, Medianos

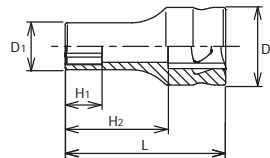

RS2300XZ/9 Socket Set on Rail Juego de Vasos en Regleta



2300MZ 6-point Deep Sockets Vasos Hexagonales Largos

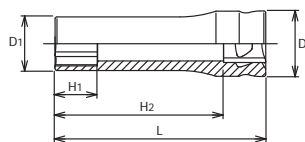

RS2300MZ/12 Socket Set on Rail Juego de Vasos en Regleta



Z-series 1/4"

Z-SERIES

HAND
MANUALES

TITANIUM
DE TITANIO

ACCESSORIES
ACCESORIOS

SCREWDRIVERS
DESTORNILLADORES

IMPACT
DE IMPACTO

SLEEVE-DRIVE

INDUSTRIAL
INDUSTRIALES

PROTECTOR
PROTECTORES

AUTOMOTIVE

CONSTRUCTION
CONSTRUCCIÓN

RENEWAL KITS
JUEGOS DE PIEZAS REPUESTO

2000Z-28 • -50 Phillips Bit Sockets Vasos con Punta Phillips

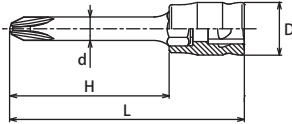

2000Z.28 (PH)	D (mm)	H (mm)	L (mm)	(g)	(pcs.)
1	11.2	12	28	9	10
2	11.2	12	28	10	10
3	11.2	12	28	10	10

2000Z.50 (PH)	D (mm)	d (mm)	H (mm)	L (mm)	(g)	(pcs.)
1	11.2	4	34	50	11	10
2	11.2	5	34	50	13	10
3	11.2	-	34	50	16	10

2005Z-25 Slotted Bit Sockets Vasos con Punta Recta para Cabeza Ranurada

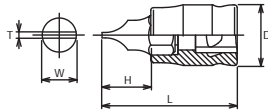

2005Z.25	T x W (mm)	D (mm)	H (mm)	L (mm)	(g)	(pcs.)
5	1.0 x 5.5	11.2	9	25	9	10
6	1.2 x 6.5	11.2	9	25	10	10

2010MZ-25 • -50 Inhex Bit Sockets Vasos con Punta Hexagonal

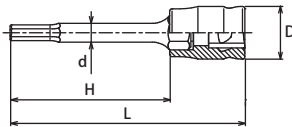

2010MZ.25 (mm)	D (mm)	H (mm)	L (mm)	(g)	(pcs.)
3	11.2	9	25	9	10
4	11.2	9	25	9	10
5	11.2	9	25	10	10
6	11.2	9	25	10	10

2010MZ.50 (mm)	D (mm)	d (mm)	H (mm)	L (mm)	(g)	(pcs.)
3	11.2	4	34	50	11	10
4	11.2	5	34	50	13	10
5	11.2	6	34	50	15	10
6	11.2	-	34	50	17	10

RS20XXZ/9 Socket Set on Rail Juego de Vasos en Regleta



RS20XXZ/9		9 Pieces Set/Rail 200mm	(g)
2000Z.28		1, 2, 3	213
2005Z.25		5, 6	
2010MZ.25		3, 4, 5, 6	

2025Z.28 (T)	D (mm)	H (mm)	L (mm)	(g)	(pcs.)
T10	11.2	12	28	9	10
T15	11.2	12	28	9	10
T20	11.2	12	28	9	10
T25	11.2	12	28	10	10
T27	11.2	12	28	10	10
T30	11.2	12	28	10	10
T40	11.2	12	28	11	10

2025Z.50 (T)	D (mm)	d (mm)	H (mm)	L (mm)	(g)	(pcs.)
T10	11.2	4	34	50	11	10
T15	11.2	4	34	50	11	10
T20	11.2	4.5	34	50	12	10
T25	11.2	5	34	50	13	10
T27	11.2	5	34	50	13	10
T30	11.2	5.6	34	50	15	10
T40	11.2	-	34	50	17	10

RS2025Z/7-L28	7 Pieces Set/Rail 200mm	(g)
T10, T15, T20, T25, T27, T30, T40		195

RS2025Z/7-L50	7 Pieces Set/Rail 200mm	(g)
T10, T15, T20, T25, T27, T30, T40		220

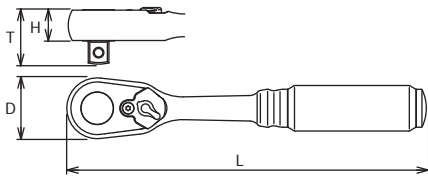

36

	D (mm)	T (mm)	H (mm)	L (mm)	(g)	(pcs.)
2725Z	20.5	17.1	9.5	114	79	2
2725Z-160	20.5	17.1	9.5	160	120	2

* Renewal Kits → 2725RK → P305

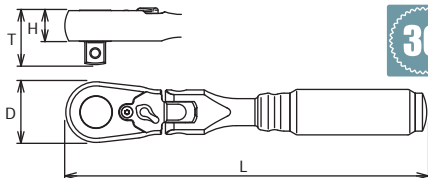

36
Flexible Head

	D (mm)	T (mm)	H (mm)	L (mm)	(g)	(pcs.)
2726Z	20.5	17.1	9.5	114	103	2
2726Z-160	20.5	17.1	9.5	160	150	2

* Renewal Kits → 2726RK → P305

2025Z-28 • -50

TORX® Bit Sockets
Vasos con Punta TORX®

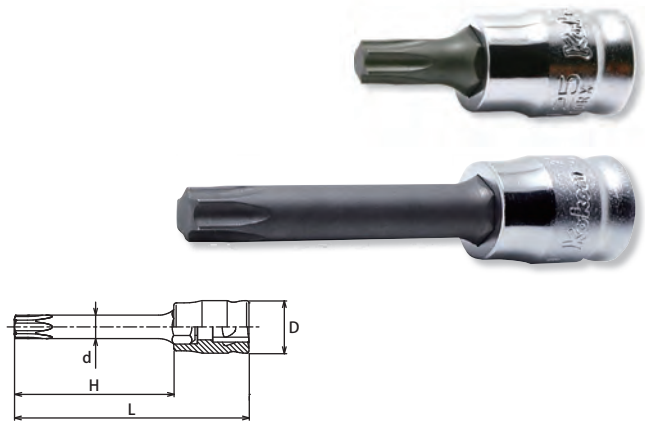

RS2025Z/7-L28 RS2025Z/7-L50

Socket Set on Rail
Juego de Vasos en Regleta



2725Z 2725Z-160

Reversible Ratchet
Llave de Carraca Reversible



2726Z 2726Z-160

Flexible Ratchet, Reversible (Short)
Llave de Carraca Flexible, Reversible (Corta)



Z-SERIES
HAND
MANUALES
TITANIUM
DE TITANIO
ACCESSORIES
ACCESORIOS
SCREWDRIVERS
DESTORNILLADORES
IMPACT
DE IMPACTO
SLEEVE-DRIVE
INDUSTRIAL
INDUSTRIALES
PROTECTOR
PROTECTORES
AUTOMOTIVE
CONSTRUCTION
CONSTRUCCION
RENEWAL KITS
JUEGOS DE PIEZAS REPUESTO

Z-series 1/4"

Z-SERIES

HAND
MANUALES

TITANIUM
DE TITANIO

ACCESSORIES
ACCESORIOS

SCREWDRIVERS
DESTORNILLADORES

IMPACT
DE IMPACTO

SLEEVE-DRIVE

INDUSTRIAL
INDUSTRIALES

PROTECTOR
PROTECTORES

AUTOMOTIVE

CONSTRUCTION
CONSTRUCCIÓN

RENEWAL KITS
JUEGOS DE PIEZAS REPUESTO

2760Z Extension Bars Alargaderas

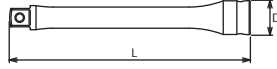

2760Z	D (mm)	L (mm)	(g)	(pcs.)
50	11.5	50	21	10
100	11.5	100	39	10
150	11.5	150	58	10

2771Z Universal Joint Articulación Universal

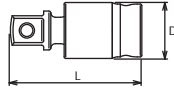

2771Z	D (mm)	L (mm)	(g)	(pcs.)
2771Z	11.7	29.9	15	10

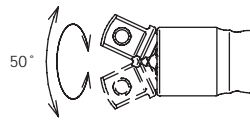

2772Z Universal Joint Articulación Universal

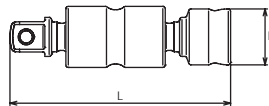

2772Z	D (mm)	L (mm)	(g)	(pcs.)
2772Z	11.7	46	26	10

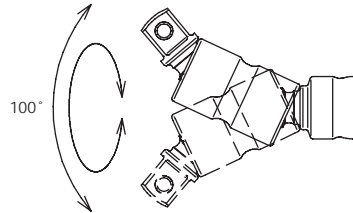

2756Z Quick Spinner Disco de Giro Rápido



2756Z	D (mm)	L (mm)	(g)	(pcs.)
2756Z	20.3	18	15	10

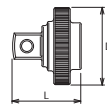

2756Z-3/8 Quick Spinner, Adaptor 2756Z-1/2









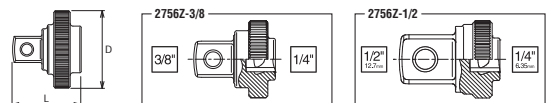

2756Z-3/8

2756Z-1/2







2756Z-3/8	D (mm)	L (mm)	(g)	(pcs.)
2756Z-3/8	20.3	21.5	24	10
New 2756Z-1/2	20.3	26	35	10



P2285Z		26 Pieces Set/△△=660g	
PLASTIC CASE:W245xH120xT45			
Sockets	Accessories		
 2400MZ 6-pt. Sockets 4, 4.5, 5, 5.5, 6, 7, 8, 10, 11, 12, 13, 14	 2725Z	 2756Z	 2771Z
 2000Z.28 1, 2, 3	 2760Z-50	 2760Z-150	
 2005Z.25 5, 6			
 2010MZ.25 3, 4, 5, 6			



P2285Z Socket Set
Juego de Vasos

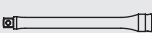

2286Z		17 Pieces Set/△△=780g	
BLACK METAL CASE:W240xH100xT32mm			
Sockets	Accessories		
 2400MZ 6-pt. Sockets 4, 5, 5.5, 6, 7, 8, 10, 11, 12, 13, 14	 2725Z	 2756Z	 2771Z
	 2760Z-50	 2760Z-100	
	 2760Z-150		

2286Z Socket Set
Juego de Vasos



2285ZE		10 Pieces Set/△△=300g	
Rail 200mm/PLASTIC BAG			
Sockets	Accessories		
 2400MZ 6-pt. Sockets 5.5, 6, 7, 8, 10, 12, 13, 14	 2725Z	 2756Z	

2285ZE Socket Set
Juego de Vasos



Z-SERIES
HAND
MANUALES
TITANIUM
DE TITANIO
ACCESSORIES
ACCESORIOS
SCREWDRIVERS
DESTORNILLADORES
IMPACT
DE IMPACTO
SLEEVE-DRIVE
INDUSTRIAL
INDUSTRIALES
PROTECTOR
PROTECTORES
AUTOMOTIVE
CONSTRUCTION
RENEWAL KITS
JUEGOS DE PIEZAS/REPUESTO

Z-series 3/8"

Z-SERIES
HAND MANUALES
TITANIUM DE TITANIO
ACCESSORIES ACCESORIOS
SCREWDRIVERS DESTORNILLADORES
IMPACT DE IMPACTO
SLEEVE-DRIVE
INDUSTRIAL INDUSTRIALES
PROTECTOR PROTECTORES
AUTOMOTIVE
CONSTRUCTION CONSTRUCCION
RENEWAL KITS JUEGOS DE PIEZAS REPUESTO

3400MZ 6-point Sockets Vasos Hexagonales

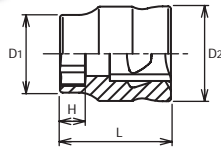

3400MZ (mm)	D ₁ (mm)	D ₂ (mm)	H (mm)	L (mm)	(g)	(pcs.)
5.5	8.5	17	3.5	19	16	10
6	9.1	17	3.5	19	17	10
7	10.3	17	3.5	19	17	10
8	11.5	17	4.5	20	17	10
10	14	17	4.5	20	18	10
11	15.3	17	5.5	21	18	10
12	16.5	17	5.5	21	19	10
13	17.8	17	8.5	21	19	10
14	19	17	8.5	21	20	10
15	20.2	18.2	8.5	21	24	10
16	21.3	19.3	8.5	21	28	10
17	22.5	20.5	8.5	21	32	10
18	23.6	21.6	9.5	22	38	10
19	24.8	22.8	9.5	22	41	10
21	27	25	10.5	23	51	10
22	28.3	26.3	10.5	23	58	10

3400MZ is designed 5-9mm shorter than standard 3400M. Ideal for working in confined and tight areas.

RS3400MZ/8 Socket Set on Rail Juego de Vasos en Regleta

RS3400MZ/12



RS3400MZ/8	8 Pieces Set/Rail 200mm	(g)
8, 10, 11, 12, 13, 14, 17, 19		320

RS3400MZ/12	12 Pieces Set/Rail 300mm	(g)
7, 8, 10, 11, 12, 13, 14, 15, 16, 17, 18, 19		490

3300XZ 6-point Sockets, Semi-Deep Vasos Hexagonales, Medianos

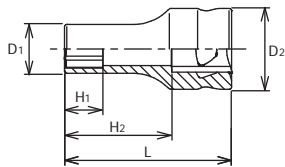

3300XZ (mm)	D ₁ (mm)	D ₂ (mm)	H ₁ (mm)	H ₂ (mm)	L (mm)	(g)	(pcs.)
7	10.3	17	8	23	35	23	10
8	11.5	17	9	23	35	24	10
10	14	17	11	23	35	26	10
11	15.3	17	12	23	35	28	10
12	16.5	17	13	23	35	29	10
13	17.8	17	14	23	35	32	10
14	19	17	16	23	35	34	10
15	20.2	18.2	16	23	35	40	10
16	21.3	19.3	16.5	23	35	45	10
17	22.5	20.5	16.5	23	35	50	10
18	23.6	21.6	16.5	23	35	56	10
19	24.8	22.8	18	23	35	60	10

RS3300XZ/8 Socket Set on Rail Juego de Vasos en Regleta

RS3300XZ/12



RS3300XZ/8	8 Pieces Set/Rail 200mm	(g)
8, 10, 11, 12, 13, 14, 17, 19		420

RS3300XZ/12	12 Pieces Set/Rail 300mm	(g)
7, 8, 10, 11, 12, 13, 14, 15, 16, 17, 18, 19		630

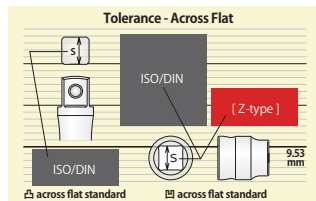
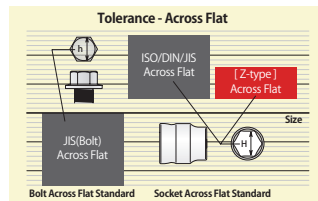

Manufacturing tolerance is precisely controlled to achieve a secure fitting.

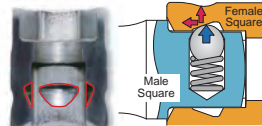

BALL HOLDING GROOVE

Original Ball Holding system is applied on Z-series. This mechanism gives secure connection between Socket and Handle.

3300MZ (mm)	D ₁ (mm)	D ₂ (mm)	H ₁ (mm)	H ₂ (mm)	L (mm)	(g)	(pcs.)
7	10.3	17	8	41.5	55	29	10
8	11.5	17	9	41.5	55	34	10
10	14	17	11	41.5	55	43	10
11	15.3	17	12	41.5	55	45	10
12	16.5	17	13	41.5	55	49	10
13	17.8	17	14	41.5	55	52	10
14	19	17	16	41.5	55	55	10
15	20.2	18.2	16	40.5	55	65	10
16	21.3	19.3	17	40.5	55	74	10
17	22.5	20.5	18	40.5	55	83	10
18	23.6	21.6	19	39.5	55	90	10
19	24.8	22.8	20	39.5	55	95	10

RS3300MZ/8	8 Pieces Set/Rail 200mm	(g)
8, 10, 11, 12, 13, 14, 17, 19		600

RS3300MZ/12	12 Pieces Set/Rail 300mm	(g)
7, 8, 10, 11, 12, 13, 14, 15, 16, 17, 18, 19		900

RS3X00MZ/12	12 Pieces Set/Rail 300mm	(g)
3400MZ	8, 10, 11, 12, 13, 14, 17, 19	550
3300MZ	8, 10, 12, 14	

3300CZ (mm)	D (mm)	H (mm)	L (mm)	(g)	(pcs.)
14	18.4	11	70	67	10
16	20.5	13	70	71	10
18	22.9	12	70	75	10
20.8	26.3	13.5	70	105	10

Slim & light weight body with smaller outside diameter for work in tight spaces.

⚠ Spring clip type spark plug sockets caused deforming the clip if it would be used with shallow engagement.



3305PZ (mm)	D (mm)	H (mm)	L (mm)	(g)	(pcs.)
14	17.9	8	70	56	10
16	20	8	70	55	10

Spark Plug Socket with Magnet, 12-pt. opening: size 14mm



⚠ The magnet could be broken with any impacts. Please handle with care.

3300MZ 6-point Deep Sockets Vasos Hexagonales Largos

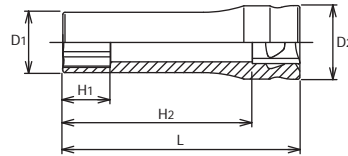

RS3300MZ/8 Socket Set on Rail Juego de Vasos en Regleta

RS3300MZ/12



RS3X00MZ/12 Socket Set on Rail Juego de Vasos en Regleta



3300CZ Spark Plug Sockets with Spring Clips Llaves de Bujía con Presillas ⚠

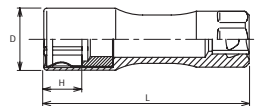

3305PZ Spark Plug Socket with Magnet, 12-pt. opening Llaves de bujía con Imán, Boca Bihex ⚠

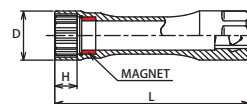

Z-SERIES
HAND MANUALES
TITANIUM DE TITANIO
ACCESSORIES ACCESORIOS
SCREWDRIVERS DESTORNILLADORES
IMPACT DE IMPACTO
SLEEVE-DRIVE
INDUSTRIAL INDUSTRIALES
PROTECTOR PROTECTORES
AUTOMOTIVE
CONSTRUCTION CONSTRUCCION
RENEWAL KITS JUEGOS DE HERRAMIENTAS

Z-series 3/8"

Z-SERIES

HAND
MANUALES

TITANIUM
DE TITANIO

ACCESSORIES
ACCESORIOS

SCREWDRIERS
DESTORNILLADORES

IMPACT
DE IMPACTO

SLEEVE-DRIVE

INDUSTRIAL
INDUSTRIALES

PROTECTOR
PROTECTORES

AUTOMOTIVE

CONSTRUCTION
CONSTRUCCIÓN

RENEWAL KITS
JUEGOS DE PIEZAS/REPUÉSTO

3010MZ-50 • -75 Inhex Bit Sockets Vasos con Punta Hexagonal

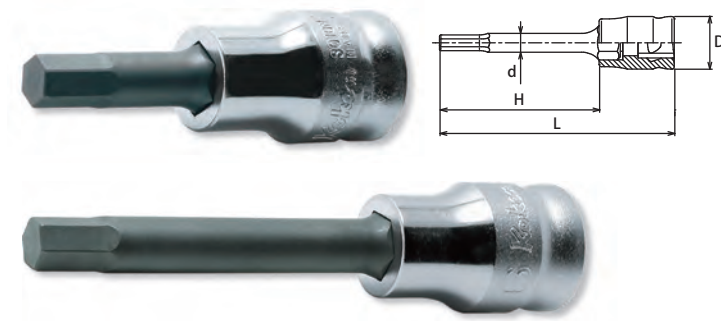

3010MZ.50 (mm)	D (mm)	d (mm)	H (mm)	L (mm)	(g)	(pcs.)
3	17	4	23.5	50	28	10
4	17	5	23.5	50	29	10
5	17	6	23.5	50	30	10
6	17	7	23.5	50	35	10
7	17	-	23.5	50	38	10
8	17	-	23.5	50	40	10
10	17	-	23.5	50	50	10
12	19	-	23.5	50	70	10

3010MZ.75 (mm)	D (mm)	d (mm)	H (mm)	L (mm)	(g)	(pcs.)
3	17	6	48.5	75	33	10
4	17	6	48.5	75	35	10
5	17	6	48.5	75	36	10
6	17	7	48.5	75	41	10
7	17	7.9	48.5	75	45	10
8	17	-	48.5	75	48	10
10	17	-	48.5	75	65	10
12	19	-	48.5	75	90	10

RS3010MZ/8-L50 Socket Set on Rail Juego de Vasos en Regleta

RS3010MZ/8-L75



RS3010MZ/8-L50	8 Pieces Set/Rail 200mm	(g)
3, 4, 5, 6, 7, 8, 10, 12		460

RS3010MZ/8-L75	8 Pieces Set/Rail 200mm	(g)
3, 4, 5, 6, 7, 8, 10, 12		530

3025Z-50 • -75 TORX® Bit Sockets Vasos con Punta TORX®

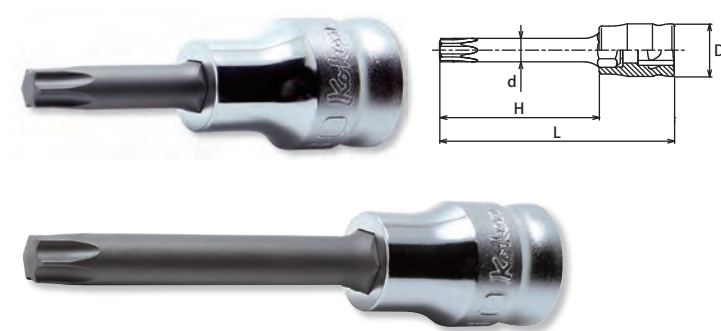

3025Z.50 (T)	D (mm)	d (mm)	H (mm)	L (mm)	(g)	(pcs.)
T10	17	3	23.5	50	27	10
T15	17	3.5	23.5	50	28	10
T20	17	3.9	23.5	50	28	10
T25	17	4.5	23.5	50	29	10
T27	17	5	23.5	50	30	10
T30	17	5.6	23.5	50	31	10
T40	17	6.7	23.5	50	35	10
T45	17	7.83	23.5	50	38	10
T50	17	8.90	23.5	50	48	10
T55	19	11.3	23.5	50	70	10

3025Z.75 (T)	D (mm)	d (mm)	H (mm)	L (mm)	(g)	(pcs.)
T20	17	4.5	48.5	75	32	10
T25	17	5	48.5	75	33	10
T27	17	5	48.5	75	33	10
T30	17	5.6	48.5	75	35	10
T40	17	6.7	48.5	75	41	10
T45	17	7.9	48.5	75	45	10
T50	17	8.9	48.5	75	55	10
T55	19	11.3	48.5	75	80	10

RS3025Z/8-L50 Socket Set on Rail Juego de Vasos en Regleta

RS3025Z/8-L75



RS3025Z/8-L50	8 Pieces Set/Rail 200mm	(g)
T20, T25, T27, T30, T40, T45, T50, T55		450

RS3025Z/8-L75	8 Pieces Set/Rail 200mm	(g)
T20, T25, T27, T30, T40, T45, T50, T55		480

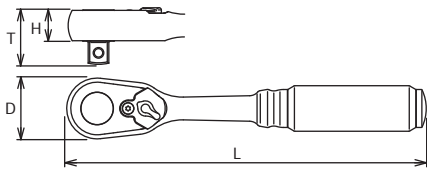

36

	D (mm)	T (mm)	H (mm)	L (mm)	(g)	(pcs.)
2725Z-3/8	20.5	20.5	9.5	114	83	2
New 2725Z-3/8 (L160)	20.5	20.5	9.5	160	120	2

* Renewal Kits → 2725RK-3/8 → P305

2725Z-3/8 Reversible Ratchet Short
Llave de Carraca Reversible Corta
2725Z-3/8 (L160)

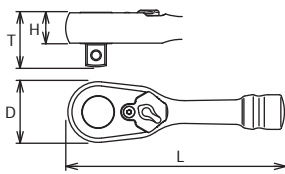

36

	D (mm)	T (mm)	H (mm)	L (mm)	(g)	(pcs.)
3725ZS	28	24.5	13.7	100	157	2

* Renewal Kits → 3725RK → P305

3725ZS Reversible Ratchet Short
Llave de Carraca Reversible Corta

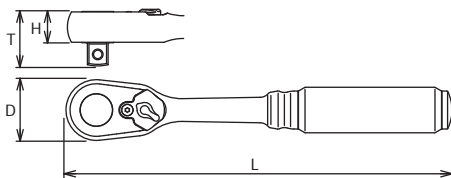

36

	D (mm)	T (mm)	H (mm)	L (mm)	(g)	(pcs.)
3725Z	28	24.5	13.7	178	254	1
3725Z-280	28	24.5	13.7	280	360	1

* Renewal Kits → 3725RK → P305

3725Z Reversible Ratchet
Llave de Carraca Reversible
3725Z-280

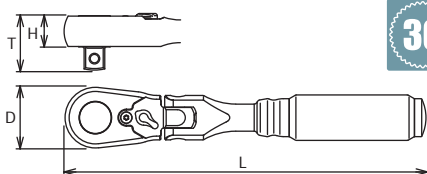

36



	D (mm)	T (mm)	H (mm)	L (mm)	(g)	(pcs.)
2726Z-3/8	20.5	20.5	9.5	114	107	2
New 2726Z-3/8 (L160)	20.5	20.5	9.5	160	130	2

* Renewal Kits → 2725RK-3/8 → P305

2726Z-3/8 Flexible Ratchet, Reversible (Short)
Llave de Carraca Flexible, Reversible (Corta)
2726Z-3/8 (L160)



Z-SERIES
HAND
MANUALES
TITANIUM
DE TITANIO
ACCESSORIES
ACCESORIOS
SCREWDRIVERS
DESTORNILLADORES
IMPACT
DE IMPACTO
SLEEVE-DRIVE
INDUSTRIAL
INDUSTRIALES
PROTECTOR
PROTECTORES
AUTOMOTIVE
CONSTRUCTION
CONSTRUCCION
RENEWAL KITS
JUEGOS DE PIEZAS/REPUESTO

Z-series 3/8"

Z-SERIES

HAND
MANUALES

TITANIUM
DE TITANIO

ACCESSORIES
ACCESORIOS

SCREWDRIVERS
DESTORNILLADORES

IMPACT
DE IMPACTO

SLEEVE-DRIVE
MANGOS

INDUSTRIAL
INDUSTRIALES

PROTECTOR
PROTECTORES

AUTOMOTIVE

CONSTRUCTION
CONSTRUCCIÓN

RENEWAL KITS
JUEGOS DE PIEZAS/REPUES

3726ZS Flexible Ratchet, Reversible (Short)
Llave de Carraca Flexible, Reversible (Corta)

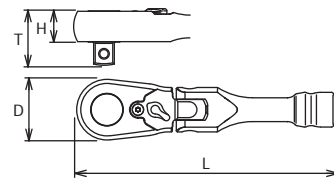

	D (mm)	T (mm)	H (mm)	L (mm)	(g)	(pcs.)
3726ZS	28	24.5	13.7	120	196	2

* Renewal Kits → 3725RK → P305

3726Z
3726Z-280 Flexible Ratchet, Reversible
Llave de Carraca Flexible, Reversible

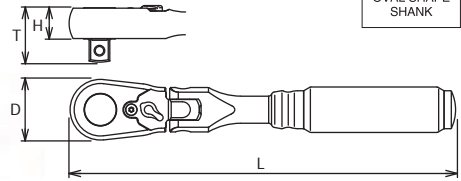
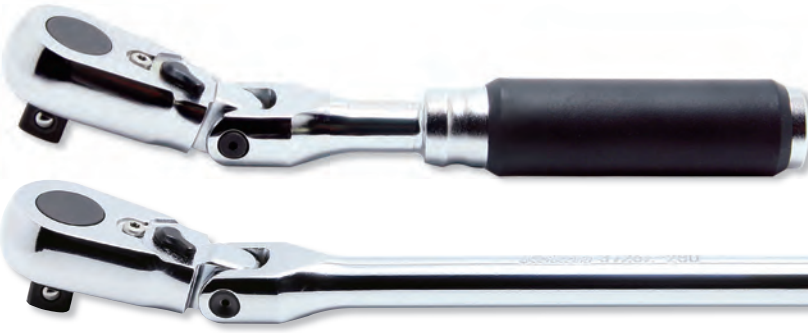

	D (mm)	T (mm)	H (mm)	L (mm)	(g)	(pcs.)
3726Z	28	24.5	13.7	178	317	1
3726Z-280	28	24.5	13.7	280	420	1

* Renewal Kits → 3725RK → P305

3768Z-250
3768Z-400 Hinge Handle
Mango Articulado

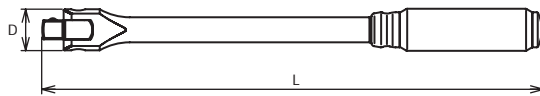

	D (mm)	L (mm)	(g)	(pcs.)
3768Z				
250	20.5	250	309	5
400	20.5	400	500	2

* Renewal Kits → 3768ZRK → P306

3760Z Extension Bars
Alargaderas

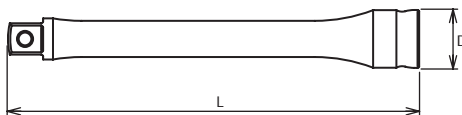

	D (mm)	L (mm)	(g)	(pcs.)
3760Z				
75	17.5	75	66	10
125	17.5	125	103	10
250	17.5	250	195	5

	D (mm)	L (mm)	(g)	(pcs.)
3771Z	18	42.5	44	10

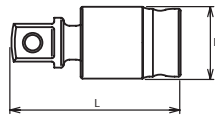
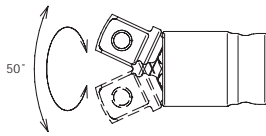

3771Z Universal Joint
Articulación Universal



	D (mm)	L (mm)	(g)	(pcs.)
3772Z	17	65	76	10

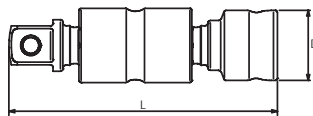
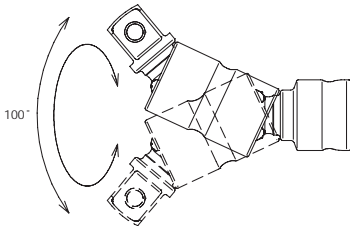

3772Z Universal Double Joint
Articulación Universal



	D (mm)	L (mm)	(g)	(pcs.)
3756Z	28	25	40	10

Outside diameter is smaller compared to standard 3756.
Ideal for working in combination with 3725Z



3756Z Quick Spinner
Disco de Giro Rápido

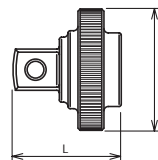

	D (mm)	L (mm)	(g)	(pcs.)
3756ZS	20.3	25	26	10

Ideal for working in combination with 2725Z-3/8 and 2726Z-3/8.

3756ZS Quick Spinner
Disco de Giro Rápido

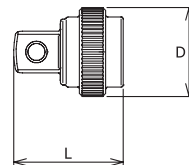

	D (mm)	L (mm)	(g)	(pcs.)
New 3756Z-1/2	28	29	52	10

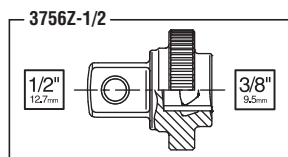

3756Z-1/2 Quick Spinner, Adaptor

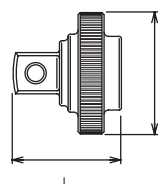

	D (mm)	L (mm)	(g)	(pcs.)
3322AZ-75	17.5	75	42	10

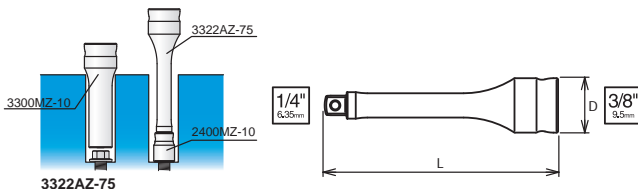

3322AZ-75 Extension Adaptor
Adaptador Alargadera



Z-SERIES
HAND
MANUALES
TITANIUM
DE TITANIO
ACCESSORIES
ACCESORIOS
SCREWDRIVERS
DESTORNILLADORES
IMPACT
DE IMPACTO
SLEEVE-DRIVE
INDUSTRIAL
INDUSTRIALES
PROTECTOR
PROTECTORES
AUTOMOTIVE
CONSTRUCTION
CONSTRUCCION
RENEWAL KITS
JUEGOS DE PIEZAS/REPUESTO

Z-series 3/8"

Z-SERIES

HAND
MANUALES

TITANIUM
DE TITANIO

ACCESSORIES
ACCESORIOS

SCREWDRIVERS
DESTORNILLADORES

IMPACT
DE IMPACTO

SLEEVE-DRIVE
INDUSTRIALES

INDUSTRIAL
INDUSTRIALES

PROTECTOR
PROTECTORES

AUTOMOTIVE

CONSTRUCTION
CONSTRUCCIÓN

RENEWAL KITS
JUEGOS DE PIEZAS/REPUES TO

3285Z Socket Set Juego de Vasos



3285ZA Socket Set Juego de Vasos



3286Z Socket Set Juego de Vasos



3285ZE Socket Set Juego de Vasos



RSAL200 Rail Regleta



RSAL300 Rail CLIP.P/5



3285Z 26 Pieces Set/2,100g

PLASTIC TRAY:W390xT180xH25

Sockets	Accessories
3400MZ 6-pt. Sockets 5.5, 6, 7, 8, 10, 12, 13, 14, 17, 19, 21, 22	3725Z 3756Z 3771Z 3768Z-250 3760Z-75 3760Z-125 3760Z-250
3300MZ 6-pt. Deep Sockets 8, 10, 12, 14	
3300CZ Spark Plug Sockets 14, 16, 20.8	

3285ZA 15 Pieces Set/750g

PLASTIC TRAY:W300xT90xH25

Sockets	Accessories
3400MZ 6-pt. Sockets 5.5, 6, 7, 8, 10, 12, 13, 14, 17, 19, 21, 22	3725Z 3756Z 3771Z

3286Z 21 Pieces Set/2,600g

BLACK METAL CASE:W415xH120xT50mm

Sockets	Accessories
3400MZ 6-pt. Sockets 7, 8, 10, 11, 12, 13, 14, 15, 16, 17, 18, 19, 21, 22	3725Z 3756Z 3771Z 3768Z-250 3760Z-75 3760Z-125 3760Z-250

3285ZE 9 Pieces Set/600g

Rail 200mm/PLASTIC BAG

Sockets	Accessories
3400MZ 6-pt. Sockets 8, 10, 12, 13, 14, 17, 19	3725Z 3756Z

RSAL200	RAIL (mm)	CLIP (pcs.)	(g)	(pce.)	
1/4x12	1/4"	200	12	125	1
3/8x8	3/8"	200	8	130	1

RSAL300	RAIL (mm)	CLIP (pcs.)	(g)	(pce.)	
3/8x12	3/8"	300	12	180	1
1/2x10	1/2"	300	10	190	1

RAIL

RAIL (mm)	(g)	(pce.)	
RSAL200	200	110	1
RSAL300	300	145	1
RSAL400	400	210	1

CLIP

CLIP.P/5	(g)	(pcs.)	
1/4	1/4"	10	5
3/8	3/8"	13	5
1/2	1/2"	20	5

4400MZ (mm)	D ₁ (mm)	D ₂ (mm)	H (mm)	L (mm)	(g)	(pcs.)
8	12.6	20.6	4.5	26	30	10
10	15	20.6	4.5	26	31	10
12	17	20.6	5.5	27	32	10
13	18.3	21.5	6.5	28	40	10
14	19.5	21.5	6.5	28	40	10
16	22	21.5	7.5	29	43	10
17	23	22.5	7.5	29	49	10
18	24.1	23.7	7.5	29	56	10
19	25.3	24.4	9.5	29	62	10
21	27.6	26.3	10.5	29	76	10
22	28.8	27.5	11	29	83	10
24	31.1	29.2	12	29	96	5
27	34.6	32.2	13.5	30	124	5
30	38.1	35.2	14.5	31	156	5
32	40.4	36.8	15.5	32	178	5

4400MZ 6-point Sockets Vasos Hexagonales

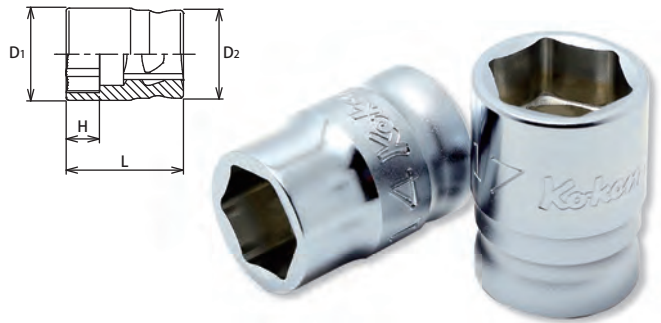

RS4400MZ/10	10 Pieces Set/Rail 300mm	(g)
10, 12, 13, 14, 17, 19, 21, 22, 24, 27		830

RS4400MZ/10 Socket Set on Rail Juego de Vasos en Regleta



36

4725Z Reversible Ratchet Llave de Carraca Reversible



	D (mm)	T (mm)	H (mm)	L (mm)	(g)	(pce.)
4725Z	36.5	32.8	18.2	253	590	1

* Renewal Kits → 4725RK → P305

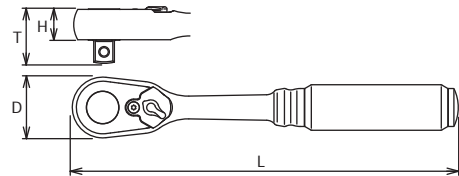

RENEWAL KIT FOR HINGE HANDLE



OVAL SHAPE SHANK



OVAL Shank



4768Z-430 Hinge Handle Mango Articulado

	D (mm)	L (mm)	(g)	(pcs.)
4768Z-430	28	430	720	2

* Renewal Kits → 4768ZRK → P306

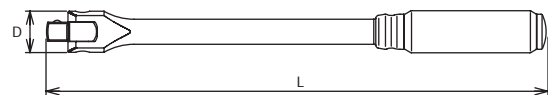

4760Z Extension Bars Alargaderas

	D (mm)	L (mm)	(g)	(pcs.)
4760Z	22.5	125	180	5
	22.5	250	340	5

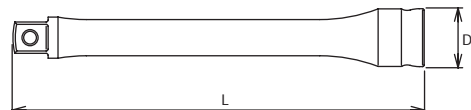

Z-SERIES
HAND
MANUALES
TITANIUM
DE TITANIO
ACCESSORIES
ACCESORIOS
SCREWDRIVERS
DESTORNILLADORES
IMPACT
DE IMPACTO
SLEEVE-DRIVE
INDUSTRIAL
INDUSTRIALES
PROTECTOR
PROTECTORES
AUTOMOTIVE
CONSTRUCTION
CONSTRUCCION
RENEWAL KITS
JUEGOS DE PIEZAS/REPUESTO

Z-series 1/2"

Z-SERIES

HAND
MANUALES

TITANIUM
DE TITANIO

ACCESSORIES
ACCESORIOS

SCREWDRIVERS
DESTORNILLADORES

IMPACT
DE IMPACTO

SLEEVE-DRIVE
MANGUITO

INDUSTRIAL
INDUSTRIALES

PROTECTOR
PROTECTORES

AUTOMOTIVE

CONSTRUCTION
CONSTRUCCIÓN

RENEWAL KITS
JUEGOS DE PIEZAS/REPUËSTO

4771Z Universal Joint
Articulaci3n Universal

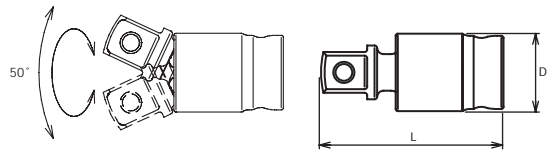

	D (mm)	L (mm)	(g)	(pcs.)
4771Z	23.7	55.8	100	10

4772Z Universal Double Joint
Articulaci3n Universal

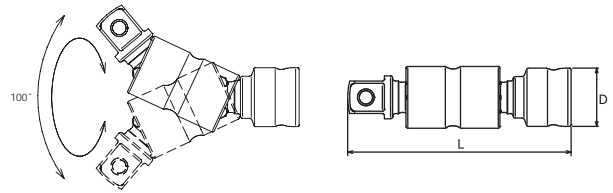

	D (mm)	L (mm)	(g)	(pcs.)
4772Z	23.7	87.2	170	5

4756Z Quick Spinner
Disco de Giro Rápido

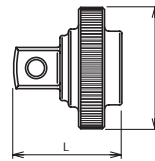

	D (mm)	L (mm)	(g)	(pcs.)
4756Z	36.3	33.5	84	10

4285Z Socket Set
Juego de Vasos

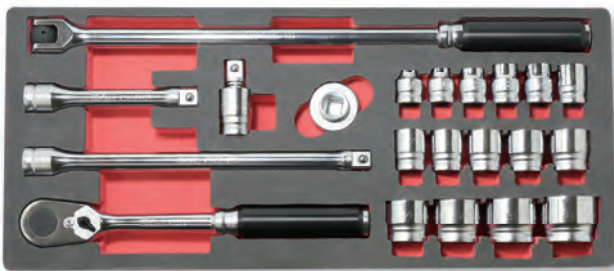

4285Z 21 Pieces Set/△=4,800g

METAL CASE:W445×T190×H50

Sockets	Accessories
4400MZ 6-pt. Sockets 8, 10, 12, 13, 14, 16, 17, 18, 19, 21, 22, 24, 27, 30, 32	4725Z 4756Z 4771Z 4768Z-430 4760Z-125 4760Z-250

4285ZE Socket Set
Juego de Vasos



4285ZE 11 Pieces Set/△=1,380g

Rail 300mm/PLASTIC BAG

Sockets	Accessories
4400MZ 6-pt. Sockets 10, 12, 13, 14, 17, 19, 21,22, 24	4725Z 4756Z

Hand Sockets

1/4"

3/8"









1/2"









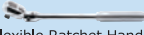

3/4"

1"

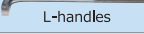

Hand Sockets

Hand Sockets	Square Drive															
	1/4"(6.35mm)SQ.			3/8"(9.5mm)SQ.			1/2"(12.7mm)SQ.			3/4"(19mm)SQ.			1"(25.4mm)SQ.			
	No.	mm	Page	No.	mm	Page	No.	mm	Page	No.	mm	Page	No.	mm	Page	
	6-point	2400M	mm	40	3400M	mm	60	4400M	mm	96	6400M	mm	126	8400M	mm	134
		2400A	inch	40	3400A	inch	60	4400A	inch	97	6400A	inch	126	8400A	inch	134
		2400W	BA	41	3400W	BSW	61	4400W	BSW	97						
	12-point	2405M	mm	40	3405M	mm	60	4405M	mm	96	6405M	mm	126	8405M	mm	134
		2405A	inch	40	3405A	inch	60	4405A	inch	97	6405A	inch	126	8405A	inch	134
	AS2405A	inch	40	3405W	BSW	61	4405W	BSW	97							
	Surface	2410M	mm	41	3410M	mm	61	4410M	mm	98						
	NUT GRIP®	2450MS	mm	42	3450M	mm	63	4450M	mm	99						
TORX® (E)	2425	TORX®	42	3425	TORX®	62	4425	TORX®	98	6425	TORX®	126				
TORX®(E) (NUT GRIP®)				3425(2B)	TORX®	63										
TORXplus® (EP)							4425-EPL	TORXplus®	99							
LH-S				3400LH	LH-STIX®	62	4400LH	LH-STIX®	99							
Double Square	2415M	mm	41	3415M	mm	62										
2415A	inch	41	3415A	inch	62											
	6-point	2300X	mm	42	3300X	mm	64									
	12-point				3305X	mm	64									
	NUT GRIP®	2350X	mm	42	3350X	mm	64									
	6-point	2300M	mm	43	3300M	mm	65	4300M	mm	100	6300M	mm	127			
		2300A	inch	43	3300A	inch	65	4300A	inch	100	6300A	inch	127			
		2300W	BA	44	3300W	BSW	66									
	12-point	2305M	mm	43	3305M	mm	65	4305M	mm	100	6305M	mm	127			
		2305A	inch	43	3305A	inch	65	4305A	inch	100	6305A	inch	127			
		AS2305A	inch	43	3305W	BSW	66									
	Surface	2310M	mm	44	3310M	mm	66	4310M	mm	101						
	NUT GRIP®	2350M	mm	44	3350M	mm	67									
TORX® (E)	2325	TORX®	44	3325	TORX®	67	4325	TORX®	101							
Flare Nut				3300FN	mm	67										
	6-point				3300M(L120)	mm	68	4300M(L120)	mm	100						
	12-point				3305M(L120)	mm	68									
	NUT GRIP®				3350M(L120)	mm	68									
	TORX® (E)							4325(L140)	TORX®	101						
	TORX®(E) (NUT GRIP®)							4325(L140)-2B	TORX®	101						
	12-point				3117M	mm	71	4117M		102						
	6-point	2440M	mm	45	3440M	mm	69	4440M	mm	102						
		2440A	inch	45	3440A	inch	69	4440A	inch	102						
	12-point	2445M	mm	45	3445M	mm	69	4445M	mm	102						
		2445A	inch	45	3445A	inch	69	4445A	inch	102						
AS2445A	inch	45	3445W	BSW	69											
NUT GRIP®	2441M	mm	45	3441M	mm	70										
TORX® (E)	2440T	TORX®	45	3440T	TORX®	69	4440T	TORX®	102							
	6-point				3340M	mm	70									
	PH	2000	PH	46	3000	PH	71	4000	PH	103						
					3001	PH	79	4001	PH	103						
	PZ	2000(PZ)	PZ	46	3000(PZ)	PZ	71	4000(PZ)	PZ	103						
	Slotted	2005	Slotted	46	3005	Slotted	71	4005	Slotted	103						
					3006	Slotted	79	4006	Slotted	103						
	Hexagon	2010M	mm	47	3010M	mm	72	4010M	mm	104	6012M	mm	127	8012M	mm	135
		2010A	inch	47	3010A	inch	72	4010A	inch	104						
					3012M	mm	73	4012M	mm	108						
					3012A	inch	73	4012A	inch	109						
	Hexagon (Grip Ring)				3015M	mm	74									
	Hexagon (Ball Point)	2011M	mm	47	3011M	mm	74									
	XZN (Triple Square)	2020	XZN	47	3020	XZN	75	4020	XZN	105						
	TORX® (T)	2025(T)	TORX®	48	3025(T)	TORX®	76	4025(T)	TORX®	106						
	TORX® (TH)	2025(TH)	TORX®	48	3025(TH)	TORX®	77									
TORXplus® (IP)	2025(IP)	TORXplus®	49	3025(IP)	TORXplus®	78	4025(IP)	TORXplus®	107							
TORXplus® (IPR)	2025(IPR)	TORXplus®	49	3025(IPR)	TORXplus®	78										
Ribe CV				3027	Ribe CV	79	4027	Ribe CV	107							
	Hexagon	2430M	mm	46	3430M	mm	70									
	TORX® (T)	2430T	TORX®	6												

Handles/Accessories		Square Drive									
		1/4"(6.35mm)SQ.		3/8"(9.5mm)SQ.		1/2"(12.7mm)SQ.		3/4"(19mm)SQ.		1"(25.4mm)SQ.	
		No.	Page	No.	Page	No.	Page	No.	Page	No.	Page
 Ratchet Handles	Standard	2753 series 2752 series	50-51 51	3749N 3753 series 3752 series	80 82-83 81	4749N-250 4753 series 4750 series 4752 series	110 112-113 111 112	6749 6752	128 128	8749	136
	Short	2753PS series	50	3749S series	80						
	Long	2753P-160	50	3753P-250	82	4749-380 series 4753P-410	110 112	6749-1000	128	8749-1000	136
	Compact			2749-3/8 series	80	3749S-1/2 series	110				
	Others			3753SM series 3757	82-83 87						
 Flexible Ratchet Handles	Standard	2774 series	52	3774 series	84-86	4774 series	114-115				
	Short	2774PS 2774JS	51 51	3774PS	84						
	Long					4774P-450	114				
	Compact			2774-3/8 series	84						
	Swivel Head			3776 series	81						
	Speeder			3774P-SR	85						
 Hinge Handles	Standard	2768 series	53	3768-250 series	89	4768-380 series	116	6768	130	8768	136
	Short			3768N-175	89	4768N-300	116				
	Long			3768N-300	89	4768-450 series	116	6768-600	130	8768-1000	136
	Extra Long			3768P-380	89	4768-600 series	116	6768-1000	130		
 T-type Slide Handles	Standard	2785 series	55	3785	91	4785	119	6785	130	8785	136
	Long									8785-700	136
 Spin Type Handles	Standard	2769N	54	3769N	90						
	Wobble-Fix	2769NWF	54	3769NWF	90						
	Others	2769F 2769H	54 54	3769H	90						
 L-handles						4788 4747	119 119	6788	130	8788	136
 Speed Handles	Standard	2780	55	3780	91	4780-400	118				
	Flexible					4781N-450	117				
 Extension Bars	Standard	2760	53	3760	88	4760	118	6760	129	8760	135
	Wobble-Fix	2763	53	3763	88	4763	118				
	Flexible	2762	52	3762	87						
 Universal Joints		2770 2771	55 55	3770 3771	90 90	4770 4771	117 117	6770	131	8770	135
	Adaptors	2233A	55	3322A 3344A	91 91	4433A 4466A	119 119	6644A 6688A	131 131	8866A	135
 Ratchet Adaptors		2755	52	3755	87	4755	117	6755	129		
 Quick Spinners		2756	52	3756	87	4756	117				

Z-SERIES
HAND
MANUALES
TITANIUM
DE TITANIO
ACCESSORIES
ACCESORIOS
SCREWDRIEVERS
DESTORNILLADORES
IMPACT
DE IMPACTO
SLEEVE-DRIVE
INDUSTRIAL
INDUSTRIALES
PROTECTOR
PROTECTORES
AUTOMOTIVE
CONSTRUCTION
CONSTRUCCION
RENEWAL KITS
JUEGOS DE PIEZAS/REPOSTO

Hand Sockets 1/4"

Z-SERIES
HAND
MANUALES
TITANIUM
DE TITANIO
SCREWDRIVERS
ACCESORIES
DESTORNILLADORES
ACCESORIOS
IMPACT
DE IMPACTO
SLEEVE-DRIVE
INDUSTRIAL
INDUSTRIALES
PROTECTOR
PROTECTORES
AUTOMOTIVE
CONSTRUCTION
RENEWAL KITS
JUEGOS DE PIEZAS REPUËSTO
CONSTRUCCI3N

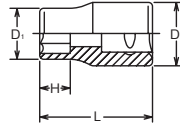

2400M • 2400A 6-point Sockets Vasos Hexagonales

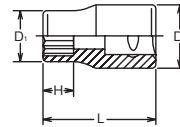

2400M 2405M (mm)	D ₁ (mm)	D ₂ (mm)	H (mm)	L (mm)	 (g)	 (pcs.)
3	5.5	11.2	2.6	22	7	10
3.5	6.1	11.2	3	22	7	10
4	6.7	11.2	3.5	22	8	10
4.5	7.3	11.2	4	22	8	10
5	8	11.2	5	22	8	10
5.5	8.5	11.2	5.5	22	9	10
6	9.2	11.2	5.5	22	9	10
7	10.3	11.2	6	22	9	10
8	11.2	11.7	6.9	22	11	10
9	13	12	7.3	22	12	10
10	14.3	12.9	7.7	22	15	10
11	15.5	14.3	9.3	22	18	10
12	16.8	15.5	9.3	22	23	10
13	18	16.4	9.8	22	23	10
14	19.3	17.9	11	24	30	10

2405M • 2405A 12-point Sockets Vasos Bihexagonales



2400A 2405A (inch)	D ₁ (mm)	D ₂ (mm)	H (mm)	L (mm)	 (g)	 (pcs.)
1/8	5.7	11.2	2.7	22	7	10
5/32	6.7	11.2	3.5	22	8	10
3/16	7.8	11.2	5	22	8	10
7/32	8.5	11.2	5.5	22	9	10
1/4	9.6	11.2	5.8	22	9	10
9/32	10.3	11.2	6	22	9	10
5/16	11.2	11.7	6.9	22	11	10
11/32	12.5	11.7	7.3	22	12	10
3/8	13.7	12.5	7.7	22	15	10
7/16	15.5	14.3	9.3	22	18	10
1/2	18	16.4	9.8	22	23	10
9/16	19.3	17.9	11	24	30	10

RS2400M/12 Socket Set on Rail Juego de Vasos en Regleta

RS2405M/12



RS2400M/12	12 Pieces Set/Rail 200mm	 (g)
4, 5, 5.5, 6, 7, 8, 9, 10, 11, 12, 13, 14		200

RS2405M/12	12 Pieces Set/Rail 200mm	 (g)
4, 5, 5.5, 6, 7, 8, 9, 10, 11, 12, 13, 14		200

RS2400A/9 Socket Set on Rail Juego de Vasos en Regleta

RS2405A/9

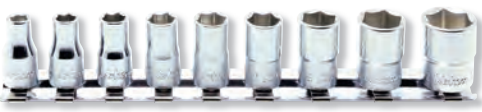



RS2400A/9	9 Pieces Set/Rail 150mm	 (g)
3/16, 7/32, 1/4, 9/32, 5/16, 11/32, 3/8, 7/16, 1/2		162

RS2405A/9	9 Pieces Set/Rail 150mm	 (g)
3/16, 7/32, 1/4, 9/32, 5/16, 11/32, 3/8, 7/16, 1/2		162

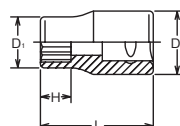
AS2405A 12-point Sockets, AS954 Vasos Bihexagonales



AS2405A (inch)	D ₁ (mm)	D ₂ (mm)	H (mm)	L (mm)	 (g)	 (pcs.)
3/16	7.7	10.9	5.1	22	8	10
7/32	8.5	10.9	5.5	22	8	10
1/4	9.4	10.9	5.9	22	8	10
9/32	10.2	10.9	6.1	22	8	10
5/16	11.3	11.7	7.3	22	10	10
11/32	12.5	12	7.5	22	10	10
3/8	13.7	12.9	8.2	22	13	10
7/16	15.6	14.3	9.4	22	17	10
1/2	17.2	16.4	10.3	22	20	10
9/16	18.8	17.9	11	24	27	10

Aerospace Standard SAE AS954
Norma Aeroespacial SAE AS954

RSAS2405A/10 Socket Set on Rail Juego de Vasos en Regleta



RSAS2405A/10	10 Pieces Set/Rail 150mm	 (g)
3/16, 7/32, 1/4, 9/32, 5/16, 11/32, 3/8, 7/16, 1/2, 9/16		160

1/4" Hand Sockets

2410M (mm)	D ₁ (mm)	D ₂ (mm)	H (mm)	L (mm)	(g)	(pcs.)
4	6.7	11.2	3.5	22	8	10
4.5	7.3	11.2	4	22	8	10
5	8	11.2	5	22	8	10
5.5	8.5	11.2	5.5	22	9	10
6	9.2	11.2	5.5	22	9	10
7	10.3	11.2	6	22	9	10
8	11.2	11.7	6.9	22	11	10
9	13	12	7.3	22	12	10
10	14.3	12.9	7.7	22	15	10
11	15.5	14.3	9.3	22	18	10
12	16.8	15.5	9.3	22	23	10
13	18	16.4	9.8	22	23	10
14	19.3	17.9	11	24	30	10

RS2410M/12	12 Pieces Set/Rail 200mm	(g)
4, 5, 5.5, 6, 7, 8, 9, 10, 11, 12, 13, 14		222

2400W (BA)	D ₁ (mm)	D ₂ (mm)	H (mm)	L (mm)	(g)	(pcs.)
8	6.1	11.2	3	22	7	10
7	7.3	11.2	4	22	8	10
6	8	11.2	5	22	8	10
5	8.5	11.2	5.5	22	9	10
4	9.6	11.2	5.8	22	9	10
3	10.3	11.2	6	22	9	10
2	11.2	11.7	6.9	22	11	10
1	13	12	7.3	22	12	10
0	14.9	13.6	8	22	16	10

RS2400W/9-BA	9 Pieces Set/Rail 150mm	(g)
8, 7, 6, 5, 4, 3, 2, 1, 0		120

BA



BA	8BA	7BA	6BA	5BA	4BA	3BA	2BA	1BA	0BA
Across Flat (ref. mm)	3.86	4.37	4.90	5.59	6.30	7.16	8.23	9.27	10.49
(ref. inch)	0.152	0.172	0.193	0.220	0.248	0.282	0.324	0.365	0.413

2415M (mm)	D ₁ (mm)	D ₂ (mm)	H (mm)	L (mm)	(g)	(pcs.)
5.5	10.3	11.2	5.4	22	10	10
6	11	11.7	5.4	22	13	10
7	12.5	11.7	6.1	22	13	10
8	14.3	12.9	6.8	22	17	10
10	17.4	16	8.2	22	27	10

2415A (inch)	D ₁ (mm)	D ₂ (mm)	H (mm)	L (mm)	(g)	(pcs.)
1/4	11	11.7	5.4	22	14	10
5/16	14.3	12.9	6.8	22	17	10
3/8	17.4	16	8.2	22	26	10

2410M Surface Drive Sockets Vasos Surface Drive (de Contacto Curvo)

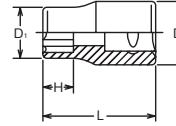

RS2410M/12 Socket Set on Rail Juego de Vasos en Regleta



2400W-BA 6-point Sockets Vasos Hexagonales

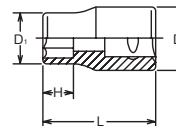

RS2400W/9-BA Socket Set on Rail Juego de Vasos en Regleta



2415M · 2415A Double Square Sockets Vasos Octagonales

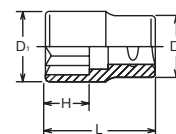

Z-SERIES
HAND
MANUALES
TITANIUM
DE TITANIO
ACCESSORIES
ACCESORIOS
SCREWDRIVERS
DESTORNILLADORES
IMPACT
DE IMPACTO
SLEEVE-DRIVE
INDUSTRIAL
INDUSTRIALES
PROTECTOR
PROTECTORES
AUTOMOTIVE
CONSTRUCTION
CONSTRUCCION
RENEWAL KITS
JUEGOS DE PIEZAS/REPUESTO

Hand Sockets 1/4"

Z-SERIES
HAND MANUALES
TITANIUM DE TITANIO
ACCESSORIES ACCESORIOS
SCREWDRIVERS DESTORNILLADORES
IMPACT DE IMPACTO
SLEEVE-DRIVE
INDUSTRIAL INDUSTRIALES
PROTECTOR PROTECTORES
AUTOMOTIVE
CONSTRUCTION CONSTRUCCIÓN
RENEWAL KITS JUEGOS DE PIEZAS REPUESTO

2425 TORX® Sockets Vasos TORX®

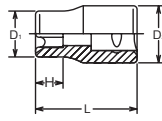

2425 (E)	D ₁ (mm)	D ₂ (mm)	H (mm)	L (mm)	(g)	(pcs.)
E 4	5.4	11.2	4.6	22	7	10
E 5	6.7	11.2	5.2	22	8	10
E 6	7.7	11.2	5.4	22	8	10
E 7	8.3	11.2	6.6	22	9	10
E 8	9.6	11.2	7	22	9	10
E10	11.3	12	8.2	22	10	10
E11	12.9	12	8.7	22	13	10
E12	14.3	12.9	9.3	23	17	10

RS2425/6 Socket Set on Rail Juego de Vasos en Regleta

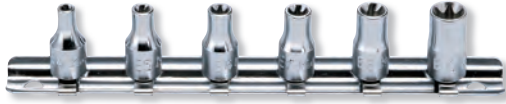

RS2425/6	6 Pieces Set/Rail 150mm	(g)
E4, E5, E6, E7, E8, E10		85

TORX® (E)

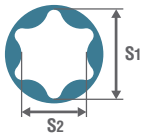

E	E4	E5	E6	E7	E8	E10	E11	E12	E14	E16	E18	E20	E22	E24	E26	E28	E30	E32
S ₁ (ref. mm)	3.7	4.6	5.6	6.1	7.4	9.3	9.9	11.0	12.8	14.6	16.5	18.3	20.1	22.0	23.7	25.5	27.3	29.0
S ₂ (ref. mm)	2.7	3.3	4.0	4.3	5.3	6.8	7.1	7.9	9.2	10.5	11.9	13.2	14.8	15.7	17.5	18.3	20.0	21.3

2450MS Nut Grip Sockets Nut Grip® Vasos Sujeta-tuercas Nut Grip®

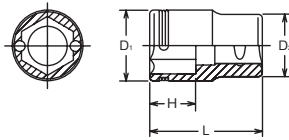

2450MS (mm)	D ₁ (mm)	D ₂ (mm)	H (mm)	L (mm)	(g)	(pcs.)
7	11.3	11.2	4	18	8	10
8	12.3	11.2	5	18	9	10
10	14.3	12.9	6	19	13	10
12	17.4	16	7	20	22	10
13	18	16.4	8	20	22	10
14	19.9	18	8.5	22	31	10

RS2450MS/6 Socket Set on Rail Juego de Vasos en Regleta



RS2450MS/6	6 Pieces Set/Rail 150mm	(g)
7, 8, 10, 12, 13, 14		120

2300X 6-point Sockets, Semi-Deep Vasos Hexagonales, Medianos

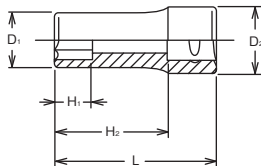

2300X (mm)	D ₁ (mm)	D ₂ (mm)	H ₁ (mm)	H ₂ (mm)	L (mm)	(g)	(pcs.)
4	6.7	11.2	4	22	32	10	10
5	8	11.2	5.5	22	32	11	10
5.5	8.5	11.2	6	22	32	12	10
6	9.2	11.2	7	22	32	12	10
7	10.5	11.2	8	22	32	13	10
8	11.8	11.2	9	22	32	16	10
9	13	12	10	22	32	18	10
10	14.3	12.9	11	21	32	23	10
11	15.5	14.3	12	21	32	27	10
12	16.8	15.5	13	21	32	29	10
13	18	16.4	14	21	32	32	10
14	19.3	17.9	16	20	32	37	10

RS2300X/12 Socket Set on Rail Juego de Vasos en Regleta



RS2300X/12	12 Pieces Set/Rail 200mm	(g)
4, 5, 5.5, 6, 7, 8, 9, 10, 11, 12, 13, 14		270

2350X Nut Grip® Socket, Semi-Deep Vasos Sujeta-tuercas Nut Grip®. Medianos

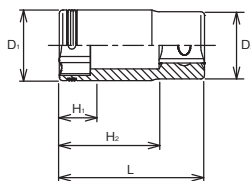

2350X (mm)	D ₁ (mm)	D ₂ (mm)	H ₁ (mm)	H ₂ (mm)	L (mm)	(g)	(pcs.)
8	12.3	11.2	5	22	32	17	10
10	14.2	12.9	6	22	32	22	10
12	17.3	16	7	22	32	34	10
14	20	18	8.5	22	32	43	10



RS2350X/4 Socket Set on Rail Juego de Vasos en Regleta



RS2350X/4	4 Pieces Set/Rail 150mm	(g)
8, 10, 12, 14		140

2300M 2305M (mm)	D ₁ (mm)	D ₂ (mm)	H ₁ (mm)	H ₂ (mm)	L (mm)	(g)	(pcs.)
3	5.5	11.2	3	40	50	15	10
4	6.7	11.2	4	40	50	15	10
4.5	7.3	11.2	4.5	40	50	15	10
5	8	11.2	5.5	40	50	17	10
5.5	8.5	11.2	6	40	50	17	10
6	9.2	11.2	7	40	50	20	10
7	10.5	11.2	8	40	50	25	10
8	11.8	11.2	9	40	50	25	10
9	13	12	10	40	50	30	10
10	14.3	12.9	11	39	50	34	10
11	15.5	14.3	12	39	50	43	10
12	16.8	15.5	13	39	50	50	10
13	18	16.4	14	39	50	52	10
14	19.3	17.9	16	38	50	57	10

2300M · 2300A 6-point Deep Sockets Vasos Hexagonales Largos

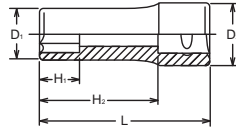

2300A 2305A (inch)	D ₁ (mm)	D ₂ (mm)	H ₁ (mm)	H ₂ (mm)	L (mm)	(g)	(pcs.)
1/8	5.7	11.2	3.5	40	50	15	10
5/32	6.7	11.2	4	40	50	15	10
3/16	7.8	11.2	5.5	40	50	17	10
7/32	8.5	11.2	6	40	50	17	10
1/4	9.8	11.2	7	40	50	25	10
9/32	10.5	11.2	8	40	50	25	10
5/16	11.8	11.2	9	40	50	25	10
11/32	12.5	11.7	10	40	50	30	10
3/8	13.7	12.5	11	40	50	34	10
7/16	15.5	14.3	12	39	50	43	10
1/2	18	16.4	14	39	50	52	10
9/16	19.3	17.9	16	38	50	57	10

2305M · 2305A 12-point Deep Sockets Vasos Bihexagonales Largos

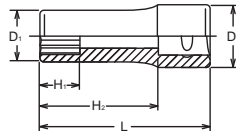

RS2300M/12	12 Pieces Set/Rail 200mm	(g)
New	4, 5, 5.5, 6, 7, 8, 9, 10, 11, 12, 13, 14	400

RS2305M/12	12 Pieces Set/Rail 200mm	(g)
New	4, 5, 5.5, 6, 7, 8, 9, 10, 11, 12, 13, 14	400

RS2300M/12 Socket Set on Rail Juego de Vasos en Regleta

RS2305M/12



RS2300A/9	9 Pieces Set/Rail 150mm	(g)
	3/16, 7/32, 1/4, 9/32, 5/16, 11/32, 3/8, 7/16, 1/2	296

RS2305A/9	9 Pieces Set/Rail 150mm	(g)
	3/16, 7/32, 1/4, 9/32, 5/16, 11/32, 3/8, 7/16, 1/2	296

RS2300A/9 Socket Set on Rail Juego de Vasos en Regleta

RS2305A/9



AS2305A (inch)	D ₁ (mm)	D ₂ (mm)	H ₁ (mm)	H ₂ (mm)	L (mm)	(g)	(pcs.)
3/16	7.7	10.9	6	40	50	17	10
7/32	8.5	10.9	6.5	40	50	17	10
1/4	9.4	10.9	7	40	50	19	10
9/32	10.2	10.9	8	40	50	18	10
5/16	11.3	11.7	9	40	50	23	10
11/32	12.5	12	10	40	50	24	10
3/8	13.7	12.8	11	39	50	31	10
7/16	15.6	14.2	12	39	50	38	10
1/2	17.2	16.2	14	39	50	42	10
9/16	18.8	17.1	16	38	50	47	10

AS2305A 12-point Deep Sockets, AS954 Vasos Bihexagonales Largos, AS954

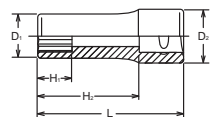

Aerospace Standard SAE AS954
Norma Aeroespacial SAE AS954

RSAS2305A/10	10 Pieces set/Rail 150mm	(g)
	3/16, 7/32, 1/4, 9/32, 5/16, 11/32, 3/8, 7/16, 1/2, 9/16	307

RSAS2305A/10 Socket Set on Rail Juego de Vasos en Regleta



Z-SERIES
HAND
MANUALES
TITANIUM
DE TITANIO
ACCESSORIES
ACCESORIOS
SCREWDRIVERS
DESTORNILLADORES
IMPACT
DE IMPACTO
SLEEVE-DRIVE
INDUSTRIAL
INDUSTRIALES
PROTECTOR
PROTECTORES
AUTOMOTIVE
CONSTRUCTION
CONSTRUCCION
RENEWAL KITS
JUEGOS DE HERRAMIENTAS

Hand Sockets 1/4"

Z-SERIES
HAND
MANUALES

TITANIUM
DE TITANIO

ACCESSORIES
ACCESORIOS

SCREWDRIVERS
DESTORNILLADORES

IMPACT
DE IMPACTO

SLEEVE-DRIVE
INDUSTRIALES

INDUSTRIAL
INDUSTRIALES

PROTECTOR
PROTECTORES

AUTOMOTIVE

CONSTRUCTION
CONSTRUCCIÓN

RENEWAL KITS
JUEGOS DE PIEZAS/REPUÉSTO

2310M Surface Drive Deep Sockets Vasos Surface Drive (de Contacto Curvo) Largos

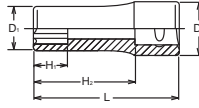

2310M (mm)	D ₁ (mm)	D ₂ (mm)	H ₁ (mm)	H ₂ (mm)	L (mm)	(g)	(pcs.)
3	5.5	11.2	3	40	50	15	10
4	6.7	11.2	4	40	50	15	10
4.5	7.3	11.2	4.5	40	50	15	10
5	8	11.2	5.5	40	50	17	10
5.5	8.5	11.2	6	40	50	17	10
6	9.2	11.2	7	40	50	20	10
7	10.5	11.2	8	40	50	25	10
8	11.8	11.2	9	40	50	25	10
9	13	12	10	40	50	30	10
10	14.3	12.9	11	39	50	34	10
11	15.5	14.3	12	39	50	43	10
12	16.8	15.5	13	39	50	50	10
13	18	16.4	14	39	50	52	10
14	19.3	17.9	16	38	50	57	10

RS2310M/12 Socket Set on Rail Juego de Vasos en Regleta



RS2310M/12	12 Pieces set/Rail 200mm	(g)
New	4, 5, 5.5, 6, 7, 8, 9, 10, 11, 12, 13, 14	400

2300W-BA 6-point Deep Sockets Vasos Hexagonales Largos

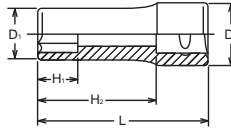
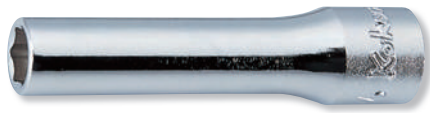

2300W (BA)	D ₁ (mm)	D ₂ (mm)	H ₁ (mm)	H ₂ (mm)	L (mm)	(g)	(pcs.)
4	9.8	11.2	7	40	50	22	10
3	10.5	11.2	8	40	50	25	10
2	11.8	11.2	9	40	50	25	10
1	13	12	10	40	50	30	10
0	14.9	13.6	12	39	50	38	10

BA



	BA	8BA	7BA	6BA	5BA	4BA	3BA	2BA	1BA	0BA
Across Flat	(ref. mm)	3.86	4.37	4.90	5.59	6.30	7.16	8.23	9.27	10.49
	(ref. inch)	0.152	0.172	0.193	0.220	0.248	0.282	0.324	0.365	0.413

2325 TORX® Deep Sockets Vasos TORX® Largos

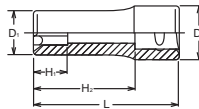

2325 (E)	D ₁ (mm)	D ₂ (mm)	H ₁ (mm)	H ₂ (mm)	L (mm)	(g)	(pcs.)
E 4	5.4	12	4.6	40	50	17	10
E 5	6.8	12	5.2	40	50	20	10
E 6	8	12	5.4	40	50	20	10
E 7	8.3	12	6.6	40	50	22	10
E 8	9.8	12	7	40	50	25	10
E10	11.6	12	8.2	40	50	29	10

TORX®
(E)

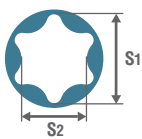

E	E4	E5	E6	E7	E8	E10	E11	E12	E14	E16	E18	E20	E22	E24	E26	E28	E30	E32
S ₁ (ref. mm)	3.7	4.6	5.6	6.1	7.4	9.3	9.9	11.0	12.8	14.6	16.5	18.3	20.1	22.0	23.7	25.5	27.3	29.0
S ₂ (ref. mm)	2.7	3.3	4.0	4.3	5.3	6.8	7.1	7.9	9.2	10.5	11.9	13.2	14.8	15.7	17.5	18.3	20.0	21.3

2350M Nut Grip Deep Sockets **Nut Grip®** Vasos Sujeta-tuerca Largos **Nut Grip®**

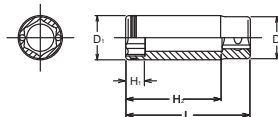
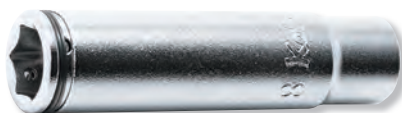

2350M (mm)	D ₁ (mm)	D ₂ (mm)	H ₁ (mm)	H ₂ (mm)	L (mm)	(g)	(pcs.)
8	12.3	11.2	5	40	50	30	10
10	14.2	12.9	6	39	50	35	10
12	17.3	16	7	39	50	55	10
14	19.9	18	8.5	38	50	70	10



RS2350M/4 Socket Set on Rail Juego de Vasos en Regleta



RS2350M/4	4 Pieces Set/Rail 150mm	(g)
	8, 10, 12, 14	220

1/4" Hand Sockets

2440M 2445M (mm)	D ₁ (mm)	D ₂ (mm)	H (mm)	L (mm)	(g)	(pcs.)
4	6.7	13	4.8	31.5	17	10
5	8	13	5.3	32	17	10
6	9.2	13	6.1	33	18	10
7	10.5	13	6.5	33	19	10
8	11.7	13	7	34	19	10
9	13	13	7	34	20	10
10	14.2	13	8.3	35	20	10
11	15.5	13	9.5	36	21	10
12	16.7	13	10	37	21	10
13	18	13	10.5	37	26	10
14	19.2	13	10.5	37	28	10

2440A (inch)	D ₁ (mm)	D ₂ (mm)	H (mm)	L (mm)	(g)	(pcs.)
1/4	9.8	13	6.5	33	18	10
5/16	11.7	13	7	34	19	10
3/8	13.7	13	8.3	35	20	10
7/16	15.5	13	9.5	36	21	10
1/2	18	13	10.5	37	26	10
9/16	19.2	13	10.5	37	28	10

2445A (inch)	D ₁ (mm)	D ₂ (mm)	H (mm)	L (mm)	(g)	(pcs.)
3/16	8	13	5.3	32	18	10
1/4	9.8	13	6.5	33	18	10
9/32	10.5	13	6.5	33	19	10
5/16	11.7	13	7	34	19	10
11/32	13	13	7	34	20	10
3/8	13.7	13	8.3	35	20	10
7/16	15.5	13	9.5	36	21	10
1/2	18	13	10.5	37	26	10
9/16	19.2	13	10.5	37	28	10

RS2445A/9	9 Pieces set/Rail 150mm	(g)
3/16, 1/4, 9/32, 5/16, 11/32, 3/8, 7/16, 1/2, 9/16		220

AS2445A (inch)	D ₁ (mm)	D ₂ (mm)	H (mm)	L (mm)	(g)	(pcs.)
1/4	9.6	12.9	5.7	31.8	18	10
5/16	11.7	12.9	7	34.6	21	10
3/8	13.5	12.9	8.3	35.1	21	10
7/16	15.5	12.9	9.5	39.1	25	10
1/2	17.2	12.9	10.5	40.1	27	10

2440T (E)	D ₁ (mm)	D ₂ (mm)	H (mm)	L (mm)	(g)	(pcs.)
E 6	8	13	5.4	31.9	20	10
E 8	9.8	13	7	33.1	20	10
E10	11.7	13	8.2	33.6	21	10
E12	14.2	13	9.3	35.1	24	10

2441M (mm)	D ₁ (mm)	D ₂ (mm)	H (mm)	L (mm)	(g)	(pcs.)
7	11.3	13	4	33	19	10
8	12.3	13	5	32	19	10
10	14.5	13	6	32.5	21	10
12	16.8	13	7	34	21	10
13	18	13	8	35	21	10
14	20	13	8.5	37	28	10



2440M • 2440A 6-point Universal Sockets Vasos Hexagonales con Articulación Universal

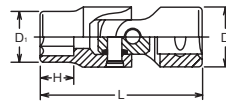

2445M • 2445A 12-point Universal Sockets Vasos Bihexagonales con Articulación Universal

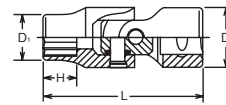

RS2445A/9 Socket Set on Rail Juego de Vasos en Regleta



AS2445A 12-point Universal Sockets Vasos Bihex con Articulación Universal

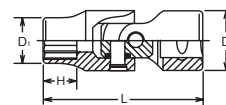

2440T TORX® Universal Sockets Vasos TORX® con Articulación Universal

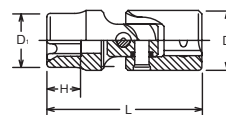

2441M Nut Grip Universal Sockets **Nut Grip®** Vasos Sujeta-Tuercas con Articulación Universal

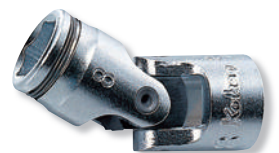
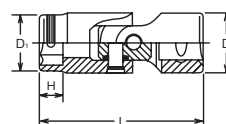

Z-SERIES
HAND
MANUALES
TITANIUM
DE TITANIO
ACCESSORIES
ACCESORIOS
SCREWDRIVERS
DESTORNILLADORES
IMPACT
DE IMPACTO
SLEEVE-DRIVE
INDUSTRIAL
INDUSTRIALES
PROTECTOR
PROTECTORES
AUTOMOTIVE
CONSTRUCTION
CONSTRUCCION
RENEWAL KITS
JUEGOS DE HEZAS/REPUESTO

Hand Sockets 1/4"

Z-SERIES

HAND
MANUALES

TITANIUM
DE TITANIO

SCREWDRIVERS
DESTORNILLADORES

IMPACT
DE IMPACTO

SLEEVE-DRIVE

INDUSTRIAL
INDUSTRIALES

PROTECTOR
PROTECTORES

AUTOMOTIVE

RENEWAL KITS
JUEGOS DE PIEZAS REPUESTO

2430M Universal Inhex Sockets Vasos Hexagonales con Articulación Universal

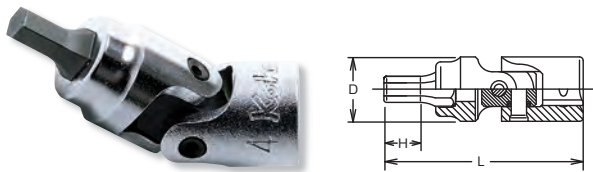

2430M (mm)	D (mm)	H (mm)	L (mm)	(g)	(pcs.)
3	13	5.5	40	18	10
4	13	5.5	40	18	10
5	13	6.5	40	20	10
6	13	7.5	40	21	10

2430T TORX® Universal Sockets Vasos TORX® con Articulación Universal

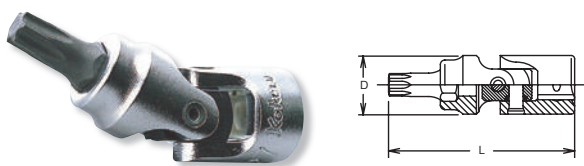

2430T (T)	D (mm)	L (mm)	(g)	(pcs.)
T 8	13	42	22	10
T 9	13	42	22	10
T10	13	42	22	10
T15	13	42	22	10
T20	13	42	22	10
T25	13	42	22	10
T27	13	42	22	10
T30	13	42	22	10

2000-28 (PH) Phillips Bit Sockets Vasos con Punta Phillips



2000.28 (PH)	D (mm)	H (mm)	L (mm)	(g)	(pcs.)
1	11.9	12	28	10	10
2	11.9	12	28	11	10
3	11.9	12	28	12	10
4	13.1	11	28	14	10

2000-28 (PZ) PZ Bit Sockets Vasos con Punta PZ



2000.28 (PZ)	D (mm)	H (mm)	L (mm)	(g)	(pcs.)
PZ1	11.9	12	28	10	10
PZ2	11.9	12	28	11	10
PZ3	11.9	12	28	12	10

2005-25 Slotted Bit Sockets Vasos con Punta Recta para Cabeza Ranurada

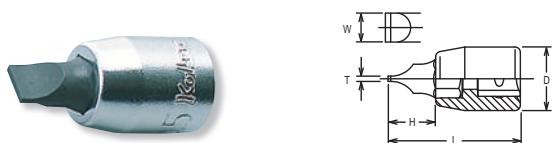

2005.25	TxW (mm)	D (mm)	H (mm)	L (mm)	(g)	(pcs.)
3	0.5x 3	11.9	9	25	9	10
4	0.8x 4	11.9	9	25	10	10
5	1.0x 5.5	11.9	9	25	10	10
6	1.2x 6.5	13.1	9	25	11	10
8	1.2x 8	13.1	9	25	12	10
9	1.6x 8	13.1	9	25	12	10
10	1.6x10	14.3	9	25	13	10

2010M.25 (mm)	D (mm)	H (mm)	L (mm)	(g)	(pcs.)
1.5	11.9	9	25	9	10
2	11.9	9	25	9	10
2.5	11.9	9	25	9	10
3	11.9	9	25	9	10
4	11.9	9	25	9	10
5	11.9	9	25	10	10
6	11.9	9	25	12	10
7	13.1	8	25	12	10
8	13.1	8	25	14	10
10	14.3	8	25	17	10
12	16.4	8	25	36	10

2010M.100 (mm)	D (mm)	H (mm)	L (mm)	(g)	(pcs.)
2	11.9	84	100	30	10
2.5	11.9	84	100	30	10
3	11.9	84	100	30	10
4	11.9	84	100	30	10
5	13.1	83	100	30	10
6	13.1	83	100	35	10
7	13.1	83	100	35	10
8	13.1	83	100	38	10
10	14.3	83	100	45	10
12	16.4	83	100	107	10

RS2010M/7-L25	7 Pieces set/Rail 150mm	(g)
3, 4, 5, 6, 7, 8, 10		115

RS2010A/8-L25	8 Pieces set/Rail 150mm	(g)
1/8, 5/32, 3/16, 7/32, 1/4, 9/32, 5/16, 3/8		130

2011M.50 (mm)	D (mm)	H (mm)	L (mm)	(g)	(pcs.)
3	11.9	34	50	16	10
4	11.9	34	50	17	10
5	11.9	34	50	18	10
6	11.9	34	50	18	10

 Ball point bit sockets have less strength due to the special design. Make sure to use them correctly.



2020.28 (XZN)	D (mm)	H (mm)	L (mm)	(g)	(pcs.)
M4	11.9	12	28	12	10
M5	11.9	12	28	12	10
M6	11.9	12	28	13	10
M8	13.1	11	28	14	10

2020.50 (XZN)	D (mm)	H (mm)	L (mm)	(g)	(pcs.)
M4	11.9	34	50	20	10
M5	11.9	34	50	20	10
M6	11.9	34	50	22	10
M8	13.1	33	50	24	10

XZN

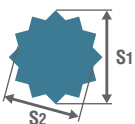

XZN		M4	M5	M6	M8	M10	M12	M14	M16	M18
S ₁	(ref. mm)	3.6	4.8	6.1	7.3	9.7	11.5	13.3	15.7	16.9
S ₂	(ref. mm)	3.1	4.1	5.1	6.1	8.1	9.7	11.2	13.2	14.2

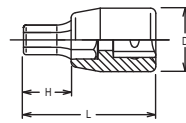

2010M-25 · -100 2010A-25

 Inhex Bit Sockets
Vasos con Punta Hexagonal



2010A.25 (inch)	D (mm)	H (mm)	L (mm)	(g)	(pcs.)
1/8	11.9	9	25	9	10
5/32	11.9	9	25	9	10
3/16	11.9	9	25	10	10
7/32	11.9	9	25	11	10
1/4	11.9	9	25	12	10
9/32	13.1	8	25	12	10
5/16	13.1	8	25	14	10
3/8	14.3	8	25	17	10

RS2010M/7-L25 RS2010A/8-L25

  Socket Set on Rail
Juego de Vasos en Regleta



2011M-50

 Ballpoint Inhex Bit Sockets
Vasos con Punta de Bola Inhex 

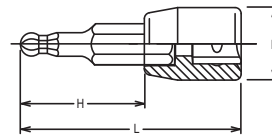

2020-28 · -50

 XZN Bit Sockets
Vasos con Punta XZN

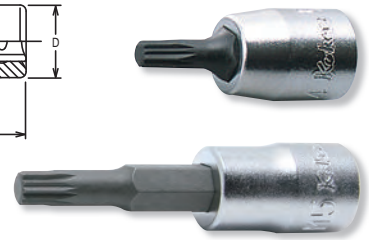
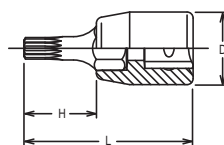

Z-SERIES
HAND
MANUALES
TITANIUM
DE TITANIO
ACCESSORIES
ACCESORIOS
SCREWDRIVERS
DESTORNILLADORES
IMPACT
DE IMPACTO
SLEEVE-DRIVE
INDUSTRIAL
INDUSTRIALES
PROTECTOR
PROTECTORES
AUTOMOTIVE
CONSTRUCTION
CONSTRUCCION
RENEWAL KITS
JUEGOS DE PIEZAS/REPLUESTO

Hand Sockets 1/4"

Z-SERIES
HAND
MANUALES

TITANIUM
DE TITANIO

ACCESSORIES
ACCESORIOS

SCREWDRIVERS
DESTORNILLADORES

IMPACT
DE IMPACTO

SLEEVE-DRIVE
MANGUITO

INDUSTRIAL
INDUSTRIALES

PROTECTOR
PROTECTORES

AUTOMOTIVE

CONSTRUCTION
CONSTRUCCIÓN

RENEWAL KITS
JUEGOS DE PIEZAS/REPUÉSTO

2025-28 · -80 (T)

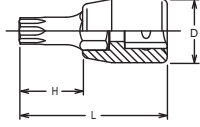

 TORX® Bit Sockets
Vasos con Punta TORX®



2025.28 (T)	D (mm)	H (mm)	L (mm)	(g)	(pcs.)
T 8	11.9	12	28	10	10
T 9	11.9	12	28	10	10
T10	11.9	12	28	10	10
T15	11.9	12	28	10	10
T20	11.9	12	28	11	10
T25	11.9	12	28	11	10
T27	11.9	12	28	12	10
T30	11.9	12	28	12	10
T40	11.9	12	28	13	10

2025.80 (T)	D (mm)	H (mm)	L (mm)	(g)	(pcs.)
T10	11.9	64	80	40	10
T15	11.9	64	80	40	10
T20	11.9	64	80	42	10
T25	11.9	64	80	42	10
T27	11.9	64	80	45	10
T30	11.9	64	80	45	10
T40	11.9	64	80	50	10

RS2025/7-L28

  Socket Set on Rail
Juego de Vasos en Regleta



RS2025/7-L28	7 Pieces set/Rail 150mm	(g)
T10, T15, T20, T25, T27, T30, T40		119

TORX®
(T)

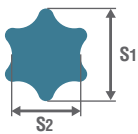

T	T8	T9	T10	T15	T20	T25	T27	T30	T40	T45	T50	T55	T60	T70	T80	T90	T100
S1 (ref. mm)	2.3	2.5	2.7	3.3	3.9	4.5	5.0	5.6	6.7	7.9	8.9	11.3	13.3	15.6	17.6	20.0	22.2
S2 (ref. mm)	1.7	1.8	2.0	2.3	2.8	3.2	3.6	4.0	4.8	5.6	6.2	8.0	9.5	11.1	12.7	14.2	15.8

2025-28 (TH)

 Tamper-Resistant TORX® Bit Sockets
Vasos con Punta TORX® Indeformable 

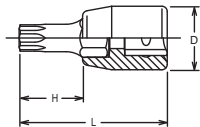

2025.28 (TH)	D (mm)	H (mm)	L (mm)	(g)	(pcs.)
T10H	11.9	12	28	10	10
T15H	11.9	12	28	10	10
T20H	11.9	12	28	11	10
T25H	11.9	12	28	11	10
T27H	11.9	12	28	12	10
T30H	11.9	12	28	12	10
T40H	11.9	12	28	13	10

RS2025/7-HOLE

  Socket Set on Rail
Juego de Vasos en Regleta



RS2025/7-HOLE	7 Pieces set/Rail 150mm	(g)
T10H, T15H, T20H, T25H, T27H, T30H, T40H		119



Tamper Resistant TORX® Bit Sockets have less strength due to special design. Make sure to use it correctly.

Los Vasos con Punta Indeformable TORX® tienen menos resistencia debido al diseño especial. Asegurarse de su correcta utilización.



1/4" Hand Sockets

2025.28 (IP)	D (mm)	H (mm)	L (mm)	(g)	(pcs.)
8IP	11.9	12	28	10	10
9IP	11.9	12	28	10	10
10IP	11.9	12	28	10	10
15IP	11.9	12	28	10	10
20IP	11.9	12	28	11	10
25IP	11.9	12	28	11	10
27IP	11.9	12	28	12	10
30IP	11.9	12	28	12	10
40IP	11.9	12	28	13	10

RS2025/7-IP	7 Pieces set/Rail 150mm	(g)
10IP, 15IP, 20IP, 25IP, 27IP, 30IP, 40IP		119

TORXPLUS® (IP)

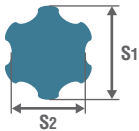

IP	8IP	9IP	10IP	15IP	20IP	25IP	27IP	30IP	40IP	45IP	50IP	55IP	60IP	70IP
S ₁ (ref. mm)	2.3	2.5	2.7	3.3	3.9	4.5	5.0	5.6	6.7	7.9	8.9	11.3	13.3	15.6
S ₂ (ref. mm)	1.7	1.8	2.0	2.3	2.8	3.2	3.6	4.0	4.8	5.6	6.2	8.0	9.5	11.1

2025-28 (IP)



TORXPLUS® Bit Sockets
Vasos con Punta TORXPLUS®

TORXplus®

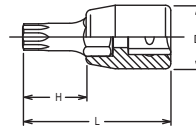

RS2025/7-IP



Socket Set on Rail
Juego de Vasos en Regleta



2025-28 (IPR)



TORXPLUS® Bit Sockets, with Hole
Vasos con Punta de Cinco Lóbulos, con agujero

TORXplus®

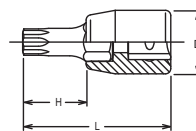

2025.28 (IPR)	D (mm)	H (mm)	L (mm)	(g)	(pcs.)
8IPR	11.9	12	28	10	10
9IPR	11.9	12	28	10	10
10IPR	11.9	12	28	10	10
15IPR	11.9	12	28	10	10
20IPR	11.9	12	28	11	10
25IPR	11.9	12	28	11	10
27IPR	11.9	12	28	12	10
30IPR	11.9	12	28	12	10
40IPR	13.1	12	28	13	10

RS2025/7-IPR	7 Pieces set/Rail 150mm	(g)
10IPR, 15IPR, 20IPR, 25IPR, 27IPR, 30IPR, 40IPR		119

TORXPLUS® (IPR)

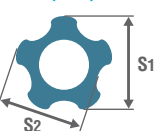

IPR	8IPR	9IPR	10IPR	15IPR	20IPR	25IPR	27IPR	30IPR	40IPR	45IPR	50IPR	55IPR
S ₁ (ref. mm)	2.2	2.4	2.6	3.1	3.6	4.1	4.7	5.2	6.3	7.4	8.4	10.6
S ₂ (ref. mm)	2.0	2.2	2.4	2.8	3.3	3.8	4.3	4.8	5.7	6.7	7.6	9.7

RS2025/7-IPR



Socket Set on Rail
Juego de Vasos en Regleta



Z-SERIES
HAND
MANUALES
TITANIUM
DE TITANIO
ACCESSORIES
ACCESORIOS
SCREWDRIVERS
DESTORNILLADORES
IMPACT
DE IMPACTO
SLEEVE-DRIVE
INDUSTRIAL
INDUSTRIALES
PROTECTOR
PROTECTORES
AUTOMOTIVE
CONSTRUCTION
CONSTRUCCION
RENEWAL KITS
JUEGOS DE PIEZAS/REPUESTO

Hand Sockets 1/4"

Z-SERIES

HAND
MANUALES

TITANIUM
DE TITANIO

ACCESSORIES
ACCESORIOS

SCREWDRIVERS
DESTORNILLADORES

IMPACT
DE IMPACTO

SLEEVE-DRIVE

INDUSTRIAL
INDUSTRIALES

PROTECTOR
PROTECTORES

AUTOMOTIVE

CONSTRUCTION
CONSTRUCCIÓN

RENEWAL KITS
JUEGOS DE PIEZAS REPUESTO

2753PS Reversible Ratchet Short
Llave de Carraca Reversible Corta



* Renewal Kits → 2753RK → P304

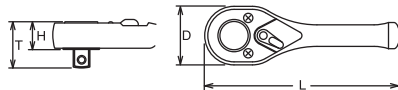

	D (mm)	T (mm)	H (mm)	L (mm)	(g)	(pcs.)
2753PS	22	18.7	11.4	75	55	5

2753N Reversible Ratchet
Llave de Carraca Reversible



* Renewal Kits → 2753RK → P304

2753P Reversible Ratchet
Llave de Carraca Reversible



* Renewal Kits → 2753RK → P304

2753J Reversible Ratchet
Llave de Carraca Reversible



* Renewal Kits → 2753RK → P304

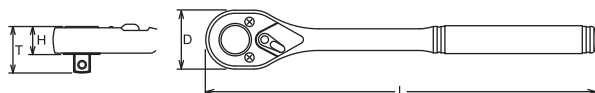

	D (mm)	T (mm)	H (mm)	L (mm)	(g)	(pcs.)
2753N	22	18.7	11.4	115	90	10
2753P	22	18.7	11.4	115	87	10
2753J	22	18.7	11.4	115	77	5

2753P-160 Reversible Ratchet Long
Llave de Carraca Reversible Larga ⚠



* Renewal Kits → 2753RK → P304

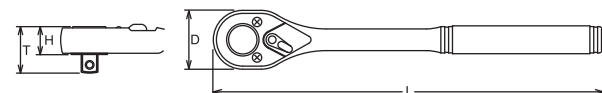

	D (mm)	T (mm)	H (mm)	L (mm)	(g)	(pcs.)
2753P-160	22	18.7	11.4	160	107	5

⚠ 2753P-160 have longer handle than standard, and can be loaded to excessive torque value. In the interest of your own safety always apply load evenly and progressively to avoid breakage and possible injury.

1/4" Hand Sockets



* Renewal Kits → 2753BRK → P304



* Renewal Kits → 2753BRK → P304



* Renewal Kits → 2753BRK → P304

	D (mm)	T (mm)	H (mm)	L (mm)	(g)	(pcs.)
2753NB	22	18.7	11.4	115	90	10
2753PB	22	18.7	11.4	115	87	10
2753JB	22	18.7	11.4	115	77	5

⚠ Reversible Ratchet with quick release button has less strength compared with normal ratchet due to the technical design. Make sure to use the ratchet correctly.

44

* Renewal Kits → 2752RK → P304

	D (mm)	T (mm)	H (mm)	L (mm)	(g)	(pcs.)
2752N	26.5	19.8	12.5	125	95	10



* Renewal Kits → 2753RK → P304



* Renewal Kits → 2753RK → P304

	D (mm)	T (mm)	H (mm)	L (mm)	(g)	(pcs.)
2774PS	22	18.7	11.4	116	110	5
2774JS	22	18.7	11.4	116	113	5

2753NB Reversible Ratchet with Quick Release Button
Llave de Carraca Reversible con botón de extracción rápida ⚠



2753PB Reversible Ratchet with Quick Release Button
Llave de Carraca Reversible con botón de extracción rápida ⚠



2753JB Reversible Ratchet with Quick Release Button
Llave de Carraca Reversible con botón de extracción rápida ⚠

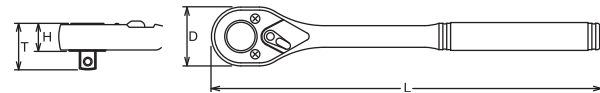

2752N Reversible Ratchet
Llave de Carraca Reversible

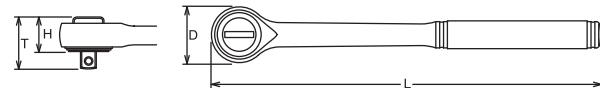

2774PS Flexible Ratchet, Reversible
Llave de Carraca Flexible, Reversible



2774JS Flexible Ratchet, Reversible
Llave de Carraca Flexible, Reversible

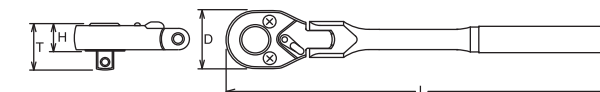

Z-SERIES
HAND
MANUALES
TITANIUM
DE TITANIO
ACCESSORIES
ACCESORIOS
SCREWDRIVERS
DESTORNILLADORES
IMPACT
DE IMPACTO
SLEEVE-DRIVE
INDUSTRIAL
INDUSTRIALES
PROTECTOR
PROTECTORES
AUTOMOTIVE
CONSTRUCTION
CONSTRUCCION
RENEWAL KITS
JUEGOS DE PIEZAS/REPUESTO

Hand Sockets 1/4"

Z-SERIES

HAND
MANUALES

TITANIUM
DE TITANIO

ACCESSORIES
ACCESORIOS

SCREWDRIVERS
DESTORNILLADORES

IMPACT
DE IMPACTO

SLEEVE-DRIVE

INDUSTRIAL
INDUSTRIALES

PROTECTOR
PROTECTORES

AUTOMOTIVE

CONSTRUCTION
CONSTRUCCIÓN

RENEWAL KITS
JUEGOS DE PIEZAS/REPUSTO

2774N Flexible Ratchet, Reversible
Llave de Carraca Flexible, Reversible



* Renewal Kits → 2753RK → P304

2774P Flexible Ratchet, Reversible
Llave de Carraca Flexible, Reversible



* Renewal Kits → 2753RK → P304

2774J Flexible Ratchet, Reversible
Llave de Carraca Flexible, Reversible



* Renewal Kits → 2753RK → P304

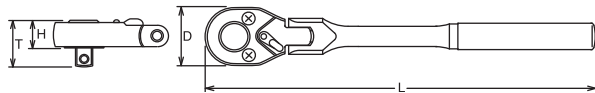

	D (mm)	T (mm)	H (mm)	L (mm)	(g)	(pcs.)
2774N	22	18.7	11.4	161	130	2
2774P	22	18.7	11.4	161	126	2
2774J	22	18.7	11.4	161	130	2

2755 Ratchet Adaptor
Adaptador de carraca

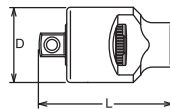

44

* Renewal Kits → 2755RK → P306

	D (mm)	L (mm)	(g)	(pcs.)
2755	26	40	80	10

2756 Quick Spinner
Disco de giro Rápido

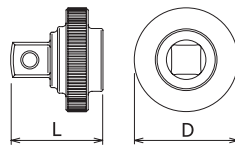

	D (mm)	L (mm)	(g)	(pcs.)
2756	22	20	19	10

2762 Flexible Extension Bar
Alargadera Flexible

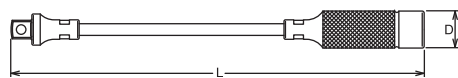

	D (mm)	L (mm)	(g)	(pcs.)
2762	13	300	90	2

2120 Magnetic Head

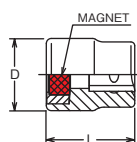

	D (mm)	L (mm)	(g)	(pcs.)
2120	14.3	17.5	21	10

2760	D (mm)	L (mm)	(g)	(pcs.)
28	12.3	28	14	10
50	12.3	50	23	10
75	12.3	75	35	10
100	12.3	100	44	10
150	12.3	150	63	10
200	12.3	200	83	10
250	12.3	250	103	10
300	12.3	300	122	2
350	12.3	350	145	2
400	12.3	400	160	2
600	12.3	600	240	2

PK2760/6	6 Pieces Set/△=430g
PLASTIC TRAY	
Extension Bars	
2760 Extension Bars 28, 50, 100, 150, 200, 250	



WOBBLE-FIX
EXTENSION BAR



2763	D (mm)	L (mm)	(g)	(pcs.)
28	12.3	28	14	10
50	12.3	50	23	10
75	12.3	75	33	10
100	12.3	100	43	10
150	12.3	150	62	10
200	12.3	200	80	10
250	12.3	250	100	10

PK2763/6	6 Pieces Set/△=420g
PLASTIC TRAY	
Extension Bars	
2763 Wobble-Fix Extension Bar 28, 50, 100, 150, 200, 250	

Wobble-Fix Extension Bar
Two way usage : One for as a flexible extension bar to provide at 15° angle operation, the other for use as a normal extension bar. This usage is Patent.

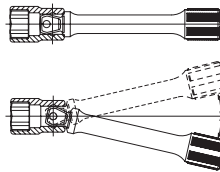

Alargadera Articulada-Fija
Dos formas de utilización : Una como alargadera flexible para poder trabajar con un ángulo de 15° y otra para utilizarse como alargadera normal. Esta aplicación está patentada.

The Wobble-Fix Extension Bar has less strength than normal extension bar due to it's specific design with a reduced square drive. Make sure to use it correctly.

* Renewal Kits → 2768RK → P306

* Renewal Kits → 2768RK → P306

* Renewal Kits → 2768RK → P306

	D (mm)	L (mm)	(g)	(pcs.)
2768N	14	130	86	10
2768P	14	130	70	10
2768J	14	130	73	5

2760 Extension Bars Alargaderas

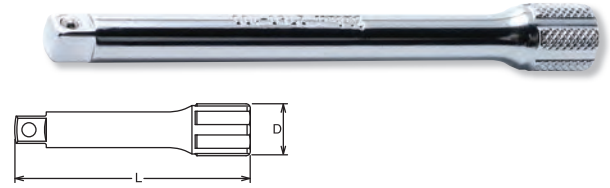

PK2760/6 Set Juego



2763 Wobble-Fix Extension Bars Alargaderas Articuladas-Fijas

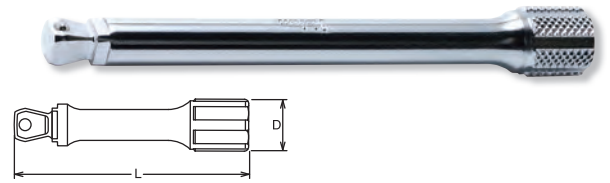

PK2763/6 Set Juego



2768N Hinge Handle Mango Articulado



2768P Hinge Handle Mango Articulado



2768J Hinge Handle Mango Articulado

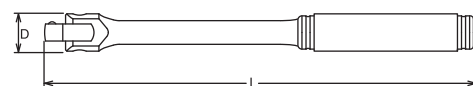

Hand Sockets 1/4"

Z-SERIES
HAND MANUALES
TITANIUM DE TITANIO
ACCESSORIES ACCESORIOS
SCREWDRIVERS DESTORNILLADORES
IMPACT DE IMPACTO
SLEEVE-DRIVE
INDUSTRIAL INDUSTRIALES
PROTECTOR PROTECTORES
AUTOMOTIVE
CONSTRUCTION CONSTRUCCIÓN
RENEWAL KITS JUEGOS DE PIEZAS REPUESTO

2769N-150 • -220 Spin Type Handle Mango Tipo Destornillador

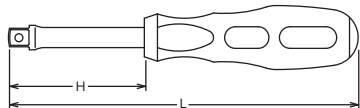

2769N	H (mm)	L (mm)	(g)	(pcs.)
150	50	150	68	2
220	120	220	100	2

⚠ Plastic or rubber handles are not intended to act as insulation.
Los mangos de plástico o de goma no están previstos para aislamiento.

2769NWF-150 • -220 Spin Type Handle(Wobble-Fix) Mango Tipo Destornillador Articulado-Fijos

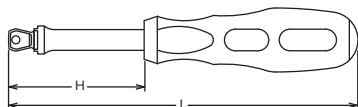

2769NWF	H (mm)	L (mm)	(g)	(pcs.)
150	50	150	68	2
220	120	220	100	2

Wobble-Fix Extension Bar

Two way usage : One for as a flexible extension bar to provide at 15° angle operation, the other for use as a normal extension bar. This usage is Patent.

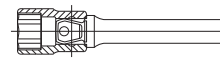

Alargadera Articulada-Fija

Dos formas de utilización : Una como alargadera flexible para poder trabajar con un ángulo de 15° y otra para utilizarse como alargadera normal. Esta aplicación está patentada.

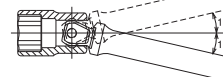

2769F Spin Type Handle Mango Tipo Destornillador

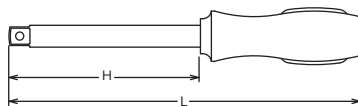

2769F	H (mm)	L (mm)	(g)	(pcs.)
2769F	78	150	90	5

2769H Folding Socket Driver Llave de Vaso Plegable

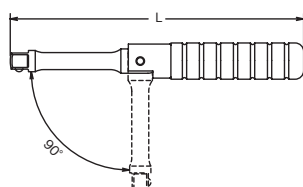

2769H	L (mm)	(g)	(pcs.)
2769H	160	180	10

	L (mm)	(g)	(pcs.)
2770	33	20	10

2770 Universal Joint
Articulación Universal

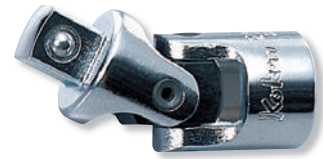
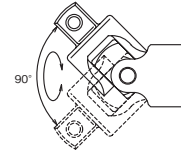
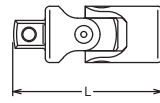

	L (mm)	(g)	(pcs.)
2771	31	20	10

2771 Universal Joint
Articulación Universal

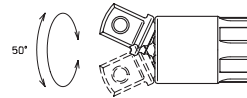
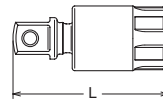

UNIVERSAL JOINT

	L (mm)	(g)	(pce.)
2780	350	250	1

2780 Speed Handle
Manivela Rápida

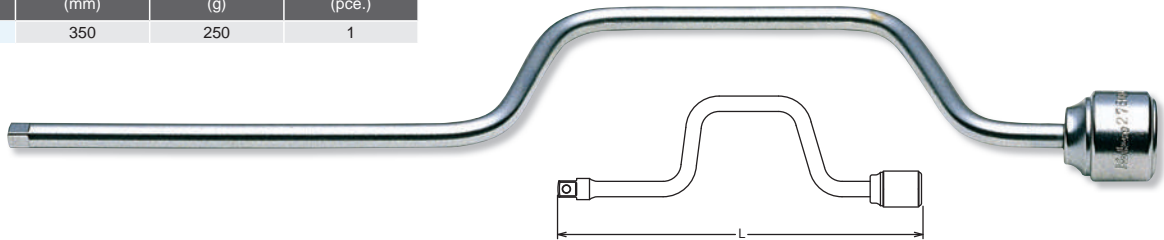

	L (mm)	(g)	(pcs.)
2785	115	36	10

2785 T-Handle
Mango Corredizo

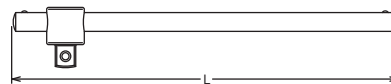

	(sq.)	(sq.)	L (mm)	(g)	(pcs.)
2233A	1/4"	3/8"	22	16	10

2233A Adaptor
Adaptador

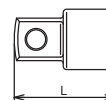

Z-SERIES
HAND
MANUALES
TITANIUM
DE TITANIO
ACCESSORIES
ACCESORIOS
SCREWDRIVERS
DESTORNILLADORES
IMPACT
DE IMPACTO
SLEEVE-DRIVE
INDUSTRIAL
INDUSTRIALES
PROTECTOR
PROTECTORES
AUTOMOTIVE
CONSTRUCTION
CONSTRUCCION
RENEWAL KITS
JUEGOS DE PIEZAS/REUESTO

Hand Sockets 1/4"

Z-SERIES
HAND MANUALES
TITANIUM DE TITANIO
ACCESSORIES ACCESORIOS
SCREWDRIVERS DESTORNILLADORES
IMPACT DE IMPACTO
SLEEVE-DRIVE
INDUSTRIAL INDUSTRIALES
PROTECTOR PROTECTORES
AUTOMOTIVE
CONSTRUCTION CONSTRUCCIÓN
RENEWAL KITS JUEGOS DE PIEZAS REPUÉSTO

2201AM Socket Set Juego de Vasos



2201AM		25 Pieces Set/△=870g
METAL CASE:W240xH100xT32mm		
Sockets	Accessories	
2400M 6-pt. Sockets 4, 5, 5.5, 6, 7, 8, 9, 10, 11, 12, 13	2753N	
2400A 6-pt. Sockets 3/16, 7/32, 1/4, 9/32, 5/16, 11/32, 3/8, 7/16, 1/2	2760-100	
	2769N-150	
	2770	
	2785	

2203M • 2203A Socket Set Juego de Vasos



2203M		12 Pieces Set/△=550g
METAL CASE:W160xH100xT28mm		
Sockets	Accessories	
2400M 6-pt. Sockets 4, 4.5, 5, 5.5, 6, 7, 8, 9, 10, 11, 13	2769H	

2203A		10 Pieces Set/△=550g
METAL CASE:W160xH100xT28mm		
Sockets	Accessories	
2400A 6-pt. Sockets 3/16, 7/32, 1/4, 9/32, 5/16, 11/32, 3/8, 7/16, 1/2	2769H	

2250M • 2250A Socket Set Juego de Vasos

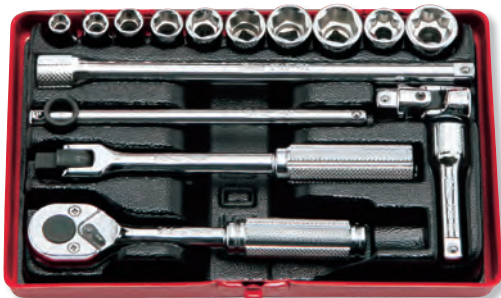

2250M		16 Pieces Set/△=700g
METAL CASE:W160xH100xT28mm		
Sockets	Accessories	
2400M 6-pt. Sockets 5, 6, 7, 8, 9, 10, 11, 12	2753N	
2415M Double Square Sockets 8, 10	2760-50	
	2760-150	
	2768N	
	2770	
	2785	

2250A		16 Pieces Set/△=700g
METAL CASE:W160xH100xT28mm		
Sockets	Accessories	
2400A 6-pt. Sockets 7/32, 1/4, 9/32, 5/16, 11/32, 3/8, 7/16	2753N	
2415A Double Square Sockets 1/4, 5/16, 3/8	2760-50	
	2760-150	
	2768N	
	2770	
	2785	

2254M Bit Set Juego de Puntas



2254M		12 Pieces Set/△=450g
METAL CASE:W160xH100xT28mm		
Bits	Accessories	
101P Phillips Bits 1, 2, 3	102NA-1/4x5/16	
101S Slotted Bits 1x7, 1.2x7	2769F	
101H Hex Bits 3, 4, 5	101A	
	2137	

2257M 31 Pieces Set/△△=930g	
METAL CASE:W240xH100xT32mm	
Sockets	Accessories
2400M 6-pt. Sockets 4, 4.5, 5, 5.5, 6, 7, 8, 9, 10, 11, 12	2753N 2760-100 2769N-150 2770 2785
2000.28 Bit Sockets 1, 2, 3, 4	
2005.25 Bit Sockets 4, 5, 6, 8, 9	
2010M.25 Bit Sockets 3, 4, 5, 6, 8, 10	

2257M Socket Set
Juego de Vasos



2260M 28 Pieces Set/△△=2,370g	
METAL CASE: W370xH150xT50mm	
Sockets	Accessories
2400M 6-pt. Sockets 4, 5, 5.5, 6, 7, 8, 10, 12	2753N 2760-50 2760-100 2769N-150
3400M 6-pt. Sockets 8, 10, 11, 12, 13, 14, 15, 17, 18, 19, 21	3749N 3760-75 3760-125 3785 3322A

2260M Socket Set
Juego de Vasos



2261M 17 Pieces Set/△△=690g	
METAL CASE:W192xH122xT30mm	
Sockets	Accessories
2400M 6-pt. Sockets 4, 4.5, 5, 5.5, 6, 7, 8, 9, 10, 11, 12	2753N 2760-50 2760-150 2768N 2770 2785

2261M Socket Set
Juego de Vasos



2262M 13 Pieces Set/△△=470g	
METAL CASE:W160xH100xT28mm	
Sockets	Accessories
2400M 6-pt. Sockets 4, 4.5, 5, 5.5, 6, 7, 8, 9, 10, 11, 12	2760-50 2768N

2262M Socket Set
Juego de Vasos



2274M 7 Pieces Set/△△=245g	
PLASTIC BAG	
Sockets	
2300M 6-pt. Deep Sockets 6, 7, 8, 9, 10, 11, 12	

2274M · 2274A Socket Set
Juego de Vasos



2274A 7 Pieces Set/△△=245g	
PLASTIC BAG	
Sockets	
2300A 6-pt. Deep Sockets 1/4, 9/32, 5/16, 11/32, 3/8, 7/16, 1/2	

Hand Sockets 1/4"

Z-SERIES

HAND
MANUALES

TITANIUM
DE TITANIO

ACCESSORIES
ACCESORIOS

SCREWDRIVERS
DESTORNILLADORES

IMPACT
DE IMPACTO

SLEEVE-DRIVE

INDUSTRIAL
INDUSTRIALES

PROTECTOR
PROTECTORES

AUTOMOTIVE

CONSTRUCTION
CONSTRUCCIÓN

RENEWAL KITS
JUEGOS DE PIEZAS REPUESTO

2275 Sockets Set
Juego de Vasos



2275		19 Pieces Set/⚖️=880g	
METAL CASE:W192xH122xT30mm			
Sockets		Accessories	
⬡	2400M 6-pt. Sockets 5.5, 6, 7, 8, 10, 12, 13		2753N
⊕	2000.28 Bit Sockets 1, 2, 3		2763-50
⊖	2005.25 Bit Sockets 6, 8		2769N-150
⬢	2010M.25 Bit Sockets 3, 4, 5, 6		

2276 Sockets Set with Bits and Accessories
Juego de vasos con Puntas y Accesorios



2276		19 Pieces Set/⚖️=640g	
METAL CASE:W192xH122xT30mm			
Bits		Accessories	
⊕	108P Phillips Bits 1, 2, 3		2753PS
⊖	108S Slotted Bits 4, 5, 6		2769N-150
⬢	108H Hex Bits 3, 4, 5, 6		2137
⬢	108T TORX® Bits T10, T15, T20, T25, T27, T30		

2277 Sockets Set
Juego de Vasos





2277		21 Pieces Set/⚖️=1,240g	
METAL CASE:W310xH90xT48mm			
Sockets		Accessories	
⬡	2400M 6-pt. Sockets 5.5, 6, 7, 8, 9, 10, 11, 12, 13		2753N
⬡	2300M 6-pt. Deep Sockets 5.5, 6, 7, 8, 9, 10, 11, 12, 13		2763-75
			2769N-150

2277A-12P Sockets Set
Juego de Vasos





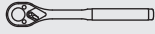
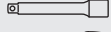

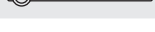
2277A-12P		21 Pieces Set/⚖️=1,240g	
METAL CASE:W310xH90xT48mm			
Sockets		Accessories	
⬡	2405A 12-pt. Sockets 7/32, 1/4, 9/32, 5/16, 11/32, 3/8, 7/16, 1/2, 9/16		2753N
⬡	2305A 12-pt. Deep Sockets 7/32, 1/4, 9/32, 5/16, 11/32, 3/8, 7/16, 1/2, 9/16		2763-75
			2769N-150

Z-SERIES
HAND
MANUALES
TITANIUM
DE TITANIO
ACCESSORIES
ACCESORIOS
SCREWDRIVERS
DESTORNILLADORES
IMPACT
DE IMPACTO
SLEEVE-DRIVE
INDUSTRIAL
INDUSTRIALES
PROTECTOR
PROTECTORES
AUTOMOTIVE
CONSTRUCTION
CONSTRUCCION
RENEWAL KITS
JUEGOS DE PIEZAS/REPLUESTO

P2201AM 25 Pieces Set/Δ=800g	
PLASTIC CASE:W245xH120xT45mm	
Sockets	Accessories
2400M 6-pt. Sockets 4, 5, 5.5, 6, 7, 8, 9, 10, 11, 12, 13 2400A 6-pt. Sockets 3/16, 7/32, 1/4, 9/32, 5/16, 11/32, 3/8, 7/16, 1/2	 2753N  2760-100  2769N-150  2770  2785

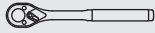

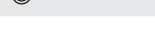

P2201AM Sockets Set
Juego de Vasos



P2251M 18 Pieces Set/Δ=770g	
PLASTIC CASE:W245xH120xT45mm	
Sockets	Accessories
2400M 6-pt. Sockets 4, 4.5, 5, 5.5, 6, 7, 8, 9, 10, 11, 12, 13	 2753N  2760-50  2760-150  2768N  2770  2785

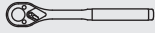
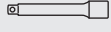



P2251M Sockets Set
Juego de Vasos

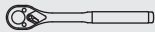

P2258M 31 Pieces Set/Δ=860g	
PLASTIC CASE:W245xH120xT45mm	
Sockets	Accessories
2400M 6-pt. Sockets 4, 5, 5.5, 6, 7, 8, 9, 10, 11, 12, 13 2000.28 Bit Sockets 1, 2, 3 2005.25 Bit Sockets 4, 6 2010M.25 Bit Sockets 3, 4, 5, 6, 8 2025.28 Bit Sockets T10, T15, T20, T25, T30	 2753N  2760-100  2769N-150  2770  2785

P2258M Sockets Set
Juego de Vasos

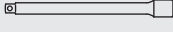

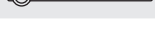
P2281A-12P 18 Pieces Set/Δ=770g	
PLASTIC CASE:W245xH120xT45mm	
Sockets	Accessories
2405A 12-pt. Sockets 1/8, 5/32, 3/16, 7/32, 1/4, 9/32, 5/16, 11/32, 3/8, 7/16, 1/2, 9/16	 2753N  2760-50  2760-150  2768N  2770  2785

P2281A-12P Sockets Set
Juego de Vasos



ABS Case - PE foam insert.
Caja ABS - espuma polietileno

Hand Sockets **3/8"**

Z-SERIES
HAND
MANUALES

TITANIUM
DE TITANIO

ACCESSORIES
ACCESORIOS

SCREWDRIVERS
DESTORNILLADORES

IMPACT
DE IMPACTO

SLEEVE-DRIVE
SISTEMA DE CONTACTO PLANO

INDUSTRIAL
INDUSTRIALES

PROTECTOR
PROTECTORES

AUTOMOTIVE

CONSTRUCTION
CONSTRUCCIÓN

RENEWAL KITS
JUEGOS DE PIEZAS REPUESTO

3400M • 3400A

6-point Sockets
Vasos Hexagonales

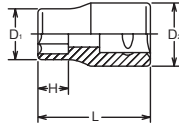

FLAT DRIVE®

3405M • 3405A

12-point Sockets
Vasos Bihexagonales

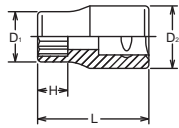

FLAT DRIVE®

Flat drive is designed to guarantee a flat surface contact between the socket and the bolt/nut. The Flat contact reduces wear and allows to transmit a higher torque value. The Flat Drive System is also used for the square drive end as well as the hexagonal or bi-hexagonal openings of the socket.

El diseño de contacto plano garantiza una superficie de contacto plana entre el vaso y el perno/tuerca. El contacto plano reduce el desgaste y permite transmitir más par. El Sistema de Contacto Plano se utiliza tanto para el extremo del cuadrado conductor como para la boca del vaso Hex o BiHex.

RS3400M/8

Socket Set on Rail
Juego de Vasos en Regleta

RS3405M/8

Socket Set on Rail
Juego de Vasos en Regleta



RS3400M/12

Socket Set on Rail
Juego de Vasos en Regleta

RS3405M/12

Socket Set on Rail
Juego de Vasos en Regleta



RS3400A/9

Socket Set on Rail
Juego de Vasos en Regleta

RS3405A/9

Socket Set on Rail
Juego de Vasos en Regleta



3400M 3405M (mm)	D ₁ (mm)	D ₂ (mm)	H (mm)	L (mm)	(g)	(pcs.)
5	8.3	17.3	5	26	20	10
5.5	8.9	17.3	5.5	26	20	10
6	9.9	17.3	6	26	20	10
7	10.8	17.3	6.5	26	20	10
8	12	17.3	7	26	22	10
9	13.3	17.3	7.5	26	23	10
10	14.5	17.3	8	26	24	10
11	15.8	17.3	8.5	26	25	10
12	16.8	17.3	9	26	25	10
13	18	17	9.5	26	24	10
14	19.5	18.5	11	27	31	10
15	20.8	19.5	11.5	28	39	10
16	22	20	12	28	42	10
17	23.3	21.5	12.5	29	51	10
18	24.5	22.5	13	30	51	10
19	25.8	23.5	13.5	30	63	10
20	27	24.5	14	31	75	10
21	28	26	14.5	32	77	10
22	29.5	26.5	15	32	82	10
23	30.8	27.5	15.5	33	95	10
24	32	28.5	16	34	102	10
25	33.3	29.5	16.5	34	115	5
26	34.5	30.5	17	35	129	5

3400A 3405A (inch)	D ₁ (mm)	D ₂ (mm)	H (mm)	L (mm)	(g)	(pcs.)
3/16	8.3	17.3	5	26	20	10
1/4	10.3	17.3	6	26	20	10
9/32	10.8	17.3	6.5	26	20	10
5/16	12	17.3	7	26	22	10
11/32	13.3	17.3	7.5	26	23	10
3/8	13.9	17.3	8	26	23	10
13/32	13.3	17.3	7.5	26	23	10
7/16	15.8	17.3	8.5	26	25	10
1/2	18	17	9.5	26	24	10
9/16	19.5	18.5	11	27	31	10
19/32	20.8	19.5	11.5	28	39	10
5/8	22	20	12	28	42	10
11/16	24.5	22.5	13	30	51	10
3/4	25.8	23.5	13.5	30	63	10
25/32	27	24.5	14	31	75	10
13/16	28	26	14.5	32	77	10
7/8	29.5	26.5	15	32	82	10
15/16	32	28.5	16	34	102	10
1	34.5	30.5	17	35	132	5

RS3400M/8	8 Pieces Set/Rail 200mm	(g)
8, 10, 11, 12, 13, 14, 17, 19		300

RS3405M/8	8 Pieces Set/Rail 200mm	(g)
8, 10, 11, 12, 13, 14, 17, 19		300

RS3400M/12	12 Pieces Set/Rail 300mm	(g)
8, 9, 10, 11, 12, 13, 14, 15, 16, 17, 18, 19		465

RS3405M/12	12 Pieces Set/Rail 300mm	(g)
8, 9, 10, 11, 12, 13, 14, 15, 16, 17, 18, 19		465

RS3400A/9	9 Pieces Set/Rail 200mm	(g)
1/4, 5/16, 3/8, 7/16, 1/2, 9/16, 5/8, 11/16, 3/4		333

RS3405A/9	9 Pieces Set/Rail 200mm	(g)
1/4, 5/16, 3/8, 7/16, 1/2, 9/16, 5/8, 11/16, 3/4		333

3410M (mm)	D ₁ (mm)	D ₂ (mm)	H (mm)	L (mm)	(g)	(pcs.)
5.5	8.9	17.3	5.5	26	20	10
6	9.9	17.3	6	26	20	10
7	10.8	17.3	6.5	26	20	10
8	12	17.3	7	26	22	10
9	13.3	17.3	7.5	26	23	10
10	14.5	17.3	8	26	24	10
11	15.8	17.3	8.5	26	25	10
12	16.8	17.3	9	26	25	10
13	18	17	9.5	26	24	10
14	19.5	18.5	11	27	31	10
15	20.8	19.5	11.5	28	39	10
16	22	20	12	28	42	10
17	23.3	21.5	12.5	29	51	10
18	24.5	22.5	13	30	51	10
19	25.8	23.5	13.5	30	63	10
20	27	24.5	14	31	75	10
21	28	26	14.5	32	77	10
22	29.5	26.5	15	32	82	10
23	30.8	27.5	15.5	33	95	10
24	32	28.5	16	34	102	10



3410M Surface Drive Sockets Vasos Surface Drive (de Contacto Curvo)

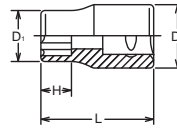

SURFACE DRIVE

Surface drive sockets are designed to retain contact with flat sides of nut to transmit high torque and reduce nut wear. These sockets are ideal for use on polished nuts, aluminum nuts and nuts with worn out points.

Los vasos de contacto curvo se diseñan para mantener el contacto con las caras planas de la tuerca y transmitir un alto par reduciendo el desgaste de la tuerca. Estos vasos son ideales para utilizarse en tuercas pulidas, tuercas de aluminio y tuercas con puntas gastadas

RS3410M/12	12 Pieces Set/Rail 300mm	(g)
8, 9, 10, 11, 12, 13, 14, 15, 16, 17, 18, 19		468

RS3410M/12 Socket Set on Rail Juego de Vasos en Regleta



3400W 3405W (W)	D ₁ (mm)	D ₂ (mm)	H (mm)	L (mm)	(g)	(pcs.)
1/8	13.3	17.3	7.5	26	22	10
3/16	15.8	17.3	8.5	26	25	10
1/4	18	17	9.5	26	24	10
5/16	20.8	19.5	11.5	28	39	10
3/8	24.5	22.5	13	30	51	10
7/16	28	26	14.5	32	81	10
1/2	30.8	27.5	15.5	33	103	10
9/16	34.5	30.5	17	35	128	5

3400W 6-point Whitworth Sockets Vasos Hexagonales Whitworth

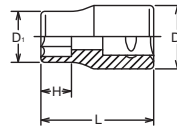

3405W 12-point Whitworth Sockets Vasos Bihexagonales Whitworth

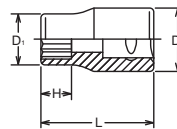

RS3400W/7	7 Pieces Set/Rail 200mm	(g)
1/8, 3/16, 1/4, 5/16, 3/8, 7/16, 1/2		389

RS3400W/7 Socket Set on Rail Juego de Vasos en Regleta

RS3405W/7

RS3405W/7	7 Pieces Set/Rail 200mm	(g)
1/8, 3/16, 1/4, 5/16, 3/8, 7/16, 1/2		389



BS W



BS - W	BS	3/16BS	1/4BS	5/16BS	3/8BS	7/16BS	1/2BS	9/16BS	5/8BS	11/16BS	3/4BS	7/8BS
	W	1/8W	3/16W	1/4W	5/16W	3/8W	7/16W	1/2W	9/16W	5/8W	11/16W	3/4W
Across Flat	(ref. mm)	8.64	11.30	13.34	15.24	18.03	20.83	23.37	25.65	27.94	30.48	33.35

Z-SERIES
HAND
MANUALES
TITANIUM
DE TITANIO
ACCESSORIES
ACCESORIOS
SCREWDRIERS
DESTORNILLADORES
IMPACT
DE IMPACTO
SLEEVE-DRIVE
INDUSTRIAL
INDUSTRIALES
PROTECTOR
PROTECTORES
AUTOMOTIVE
CONSTRUCTION
CONSTRUCCION
RENEWAL KITS
JUEGOS DE HEZAS/REPUESTO

Hand Sockets **3/8"**

Z-SERIES
HAND
MANUALES

TITANIUM
DE TITANIO

ACCESSORIES
ACCESORIOS

SCREWDRIVERS
DESTORNILLADORES

IMPACT
DE IMPACTO

SLEEVE-DRIVE
SLEEVES

INDUSTRIAL
INDUSTRIALES

PROTECTOR
PROTECTORES

AUTOMOTIVE

CONSTRUCTION
CONSTRUCCIÓN

RENEWAL KITS
JUEGOS DE PIEZAS/REPUËSTO

3415M • 3415A Double Square Sockets Vasos Octagonales

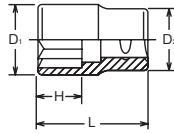

3415M (mm)	D ₁ (mm)	D ₂ (mm)	H (mm)	L (mm)	(g)	(pcs.)
5.5	10.8	17.4	5.5	26	21	10
6	12	17.3	6	26	26	10
7	13.3	17.4	6.5	26	26	10
8	14.5	17.3	7	26	26	10
10	16.8	17.3	8	26	27	10
12	20.8	19.5	9	27	43	10
13	21.9	20	9.5	27	46	10

3415A (inch)	D ₁ (mm)	D ₂ (mm)	H (mm)	L (mm)	(g)	(pcs.)
1/4	12	17.3	6	26	24	10
5/16	14.5	17.3	7	26	26	10
11/32	15.8	17.3	7.5	26	27	10
3/8	16.8	17.3	8	26	27	10
7/16	19.5	18.5	8.5	27	37	10
1/2	22	20	9.5	27	46	10

3425 TORX® Sockets Vasos TORX®

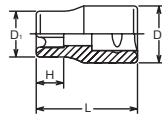

3425 (E)	D ₁ (mm)	D ₂ (mm)	H (mm)	L (mm)	(g)	(pcs.)
E 4	5.6	17.3	4.6	26	18	10
E 5	7	17.3	5.2	26	20	10
E 6	8.3	17.3	5.4	26	21	10
E 7	8.9	17.3	6.6	26	22	10
E 8	9.9	17.3	7	26	23	10
E10	12	17.3	8.2	26	24	10
E11	13.3	17.3	8.7	26	25	10
E12	14.5	17.3	9.3	26	26	10
E14	15.8	17.3	10.6	26	27	10
E16	18	17	11.8	26	27	10

RS3425/9 Socket Set on Rail Juego de Vasos en Regleta



RS3425/9	9 Pieces Set/Rail 200mm	(g)
E4, E5, E6, E7, E8, E10, E12, E14, E16		239

TORX® (E)

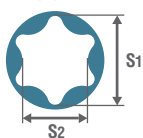

E	E4	E5	E6	E7	E8	E10	E11	E12	E14	E16	E18	E20	E22	E24	E26	E28	E30	E32
S ₁ (ref. mm)	3.7	4.6	5.6	6.1	7.4	9.3	9.9	11.0	12.8	14.6	16.5	18.3	20.1	22.0	23.7	25.5	27.3	29.0
S ₂ (ref. mm)	2.7	3.3	4.0	4.3	5.3	6.8	7.1	7.9	9.2	10.5	11.9	13.2	14.8	15.7	17.5	18.3	20.0	21.3

3400LH LHS Sockets Vasos LHS

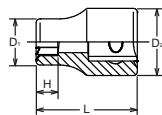

3400LH (LH-S)	D ₁ (mm)	D ₂ (mm)	H (mm)	L (mm)	(g)	(pcs.)
5S	10.8	17.3	5	26	20	10
6S	12	17.3	5.6	26	22	10
8S	15.8	17.3	6.8	26	25	10
10S	18	17	8	26	25	10
12S	22	20	9.2	28	42	10
14S	24.5	22.5	10.4	30	51	10
16S	28	26	11.6	32	77	10

RS3400LH/7 Socket Set on Rail Juego de Vasos en Regleta



RS3400LH/7	7 Pieces Set/Rail 150mm	(g)
5S, 6S, 8S, 10S, 12S, 14S, 16S		315

3450M (mm)	D ₁ (mm)	D ₂ (mm)	H (mm)	L (mm)	(g)	(pcs.)
8	12	17.3	5	26	21	10
10	14.5	17.3	6	26	24	10
11	15.8	17.3	6.5	26	26	10
12	16.8	17.3	7	26	26	10
13	18	17	8	26	28	10
14	19.5	18.5	8.5	27	34	10
15	20.8	19.5	9	27	42	10
16	22	20	9	27	50	10
17	23.3	21.5	9.5	28	62	10
18	24.5	22.5	10.5	29	64	10
19	25.8	23.3	11.5	29	66	10
21	28	26	12	29	85	10
22	29.5	27	12.5	29	90	10
24	32	30	14.5	31	102	10

RS3450M/8	8 Pieces Set/Rail 200mm	(g)
8, 10, 11, 12, 13, 14, 17, 19		310

RS3450M/10	10 Pieces Set/Rail 250mm	(g)
10, 11, 12, 13, 14, 15, 17, 19, 21, 22		500

3450MH (mm)	D (mm)	H ₁ (mm)	H ₂ (mm)	L (mm)	(g)	(pcs.)
New 8	12	5	17	26	30	10
New 10	14.5	6	17	26	30	10
New 12	16.8	7	17	26	29	10
New 13	18	8	17	26	28	10
New 14	19.5	8.5	17	27	32	10
New 17	23.3	9.5	17	29	41	10

RS3450MH/6	6 Pieces Set/Rail 150mm	(g)
8, 10, 12, 13, 14, 17		230

3425 (2B)	D ₁ (mm)	D ₂ (mm)	H (mm)	L (mm)	(g)	(pcs.)
E10	12	17.3	8.2	26	23	10
E12	14.5	17.3	9.3	26	25	10
E14	15.8	17.3	10.6	26	26	10
E16	18.1	17	11.8	26	27	10
E18	19.5	18.5	12	32	41	10
E20	21.9	20	14.4	32	52	10

RS3425/4(2B)	4 Pieces Set/Rail 150mm	(g)
E10, E12, E14, E20		150



3450M Nut Grip Sockets Nut Grip® Vasos Sujeta-tuercas Nut Grip®

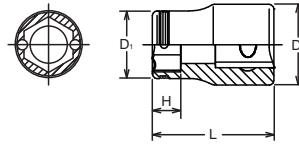

NUT GRIP®

Twin balls at the 6-point opening hold bolt-nut tightly for safe and reliable work.

Las dos bolas de la boca Hexagonal sujetan el perno-tuerca permitiendo un trabajo seguro y fiable.

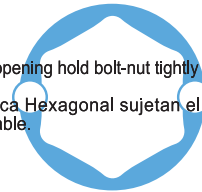

RS3450M/8 Socket Set on Rail Juego de Vasos en Regleta



RS3450M/10 Socket Set on Rail Juego de Vasos en Regleta



3450MH Nut Grip Sockets Nut Grip® Vasos Sujeta-tuercas Nut Grip®

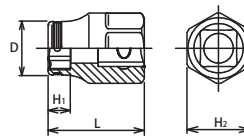

RS3450MH/6 Socket Set on Rail Juego de Vasos en Regleta



3425 (2B) TORX® Sockets Nut Grip® Vasos TORX® Nut Grip®

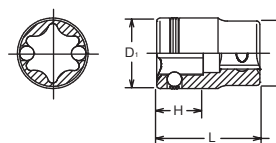

RS3425/4 (2B) Socket Set on Rail Juego de Vasos en Regleta



Z-SERIES
HAND
MANUALES
TITANIUM
DE TITANIO
ACCESSORIES
ACCESORIOS
SCREWDRIVERS
DESTORNILLADORES
IMPACT
DE IMPACTO
SLEEVE-DRIVE
INDUSTRIAL
INDUSTRIALES
PROTECTOR
PROTECTORES
AUTOMOTIVE
CONSTRUCTION
CONSTRUCCION
RENEWAL KITS
JUEGOS DE HEADS/REPUESTO

Hand Sockets **3/8"**

Z-SERIES
HAND MANUALES
TITANIUM DE TITANIO
SCREWDRIVERS ACCESSORIES DESTORNILLADORES ACCESORIOS
IMPACT DE IMPACTO
SLEEVE-DRIVE
INDUSTRIAL INDUSTRIALES
PROTECTOR PROTECTORES
AUTOMOTIVE
CONSTRUCTION CONSTRUCCION
RENEWAL KITS JUEGOS DE PIEZAS REPUESTO CONSTRUCCION

3300X • 3300XA 6-point Sockets, Semi-Deep Vasos Hexagonales, Medianos

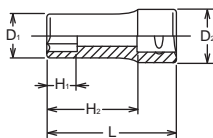

3300X 3305X (mm)	D ₁ (mm)	D ₂ (mm)	H ₁ (mm)	H ₂ (mm)	L (mm)	(g)	(pcs.)
8	12	17.3	9	26.5	40	34	10
9	13	17.3	10	26.5	40	36	10
10	14.5	17.3	11	26.5	40	36	10
11	16	17.2	12	26.5	40	36	10
12	16.8	17.2	13	26.5	40	36	10
13	18	17	14	26.5	40	37	10
14	20	18	16	26.5	40	46	10
15	21	20	16	25.5	40	49	10
16	22	20	17	25.5	40	51	10
17	23.5	22	18	25.5	40	61	10
18	24.5	23	19	24.5	40	68	10
19	25	24	20	24.5	40	75	10

3305X • 3305XA 12-point Sockets, Semi-Deep Vasos Bihexagonales, Medianos

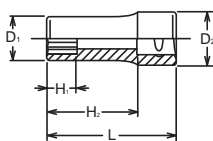

3300XA 3305XA (inch)	D ₁ (mm)	D ₂ (mm)	H ₁ (mm)	H ₂ (mm)	L (mm)	(g)	(pcs.)
1/4	10.3	17.3	7	26.5	40	32	10
5/16	12	17.3	9	26.5	40	34	10
3/8	13.9	17.3	11	26.5	40	36	10
7/16	16	17.2	12	26.5	40	36	10
1/2	18	17	14	26.5	40	37	10
9/16	20	18.5	16	26.5	40	46	10
5/8	22	20	17	25.5	40	51	10
11/16	24.5	22.5	19	24.5	40	68	10
3/4	25	23.5	20	24.5	40	75	10

RS3300X/8 Socket Set on Rail Juego de Vasos en Regleta

RS3305X/8



RS3300X/8	8 Pieces Set/Rail 200mm	(g)
8, 10, 11, 12, 13, 14, 17, 19		405

RS3305X/8	8 Pieces Set/Rail 200mm	(g)
8, 10, 11, 12, 13, 14, 17, 19		405

RS3300XA/9 Socket Set on Rail Juego de Vasos en Regleta

RS3305XA/9



RS3300XA/9	9 Pieces Set/Rail 200mm	(g)
1/4, 5/16, 3/8, 7/16, 1/2, 9/16, 5/8, 11/16, 3/4		460

RS3305XA/9	9 Pieces Set/Rail 200mm	(g)
1/4, 5/16, 3/8, 7/16, 1/2, 9/16, 5/8, 11/16, 3/4		460

3350X Nut Grip® Socket, Semi-Deep Vasos Sujeta-tuercas Nut Grip®. Medianos

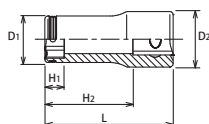

3350X (mm)	D ₁ (mm)	D ₂ (mm)	H ₁ (mm)	H ₂ (mm)	L (mm)	(g)	(pcs.)
8	12	17.4	5	26.5	40	33	10
10	14.5	17.4	6	26.5	40	35	10
12	16.8	17.2	7	26.5	40	40	10
14	19.5	18.5	8.5	26.5	40	48	10

RS3350X/4 Socket Set on Rail Juego de Vasos en Regleta



RS3350X/4	4 Pieces Set/Rail 150mm	(g)
8, 10, 12, 14		165

3300M 3305M (mm)	D ₁ (mm)	D ₂ (mm)	H ₁ (mm)	H ₂ (mm)	L (mm)	(g)	(pcs.)
5.5	8.9	17.3	6.5	41.5	55	37	10
6	9.9	17.3	7	41.5	55	37	10
7	10.6	17.3	8	41.5	55	37	10
8	12	17.3	9	41.5	55	40	10
9	13	17.3	10	41.5	55	42	10
10	14.5	17.3	11	41.5	55	46	10
11	16	17.2	12	41.5	55	51	10
12	16.8	17.2	13	41.5	55	52	10
13	18	17	14	41.5	55	53	10
14	20	18	16	41.5	55	60	10
15	21	20	16	40.5	55	74	10
16	22	20	17	40.5	55	76	10
17	23.5	22	18	40.5	55	93	10
18	24.5	23	19	39.5	55	98	10
19	25	24	20	39.5	55	98	10
20	26	25	21	49.5	65	126	10
21	27	26	22	49.5	65	126	10
22	29	28	23	48.5	65	163	10
23	30	29	24	48.5	65	168	10
24	31	30	25	47.5	65	191	10
25	33	30	26	47.5	65	199	10
26	34	31	27	47.5	65	209	10
27	35	32.5	28	47.5	65	218	10

3300A 3305A (inch)	D ₁ (mm)	D ₂ (mm)	H ₁ (mm)	H ₂ (mm)	L (mm)	(g)	(pcs.)
7/32	8.9	17.3	6	41.5	55	35	10
1/4	9.9	17.3	7	41.5	55	37	10
5/16	12	17.3	9	41.5	55	40	10
11/32	12.3	17.3	10	41.5	55	41	10
3/8	14	17.3	11	41.5	55	46	10
7/16	16	17.2	12	41.5	55	51	10
1/2	18	17	14	41.5	55	53	10
9/16	20	18	16	41.5	55	60	10
19/32	21	20	16	40.5	55	74	10
5/8	22	20	17	40.5	55	76	10
11/16	23.5	22	18	40.5	55	93	10
3/4	25	24	20	39.5	55	98	10
13/16	27	26	22	49.5	65	126	10
7/8	29	28	23	48.5	65	163	10
15/16	31	30	25	47.5	65	191	10

RS3300M/8	8 Pieces Set/Rail 200mm	(g)
8, 10, 11, 12, 13, 14, 17, 19		540

RS3305M/8	8 Pieces Set/Rail 200mm	(g)
8, 10, 11, 12, 13, 14, 17, 19		540

RS3300M/12	12 Pieces Set/Rail 300mm	(g)
8, 9, 10, 11, 12, 13, 14, 15, 16, 17, 18, 19		878

RS3305M/12	12 Pieces Set/Rail 300mm	(g)
8, 9, 10, 11, 12, 13, 14, 15, 16, 17, 18, 19		878

RS3300A/9	9 Pieces Set/Rail 200mm	(g)
1/4, 5/16, 3/8, 7/16, 1/2, 9/16, 5/8, 11/16, 3/4		628

RS3305A/9	9 Pieces Set/Rail 200mm	(g)
1/4, 5/16, 3/8, 7/16, 1/2, 9/16, 5/8, 11/16, 3/4		628

3300M · 3300A 6-point Deep Sockets Vasos Hexagonales Largos

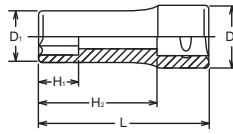

3305M · 3305A 12-point Deep Sockets Vasos Bihexagonales Largos

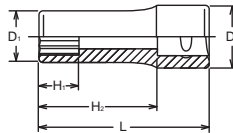

RS3300M/8 Socket Set on Rail Juego de Vasos en Regleta

RS3305M/8



RS3300M/12 Socket Set on Rail Juego de Vasos en Regleta

RS3305M/12



RS3300A/9 Socket Set on Rail Juego de Vasos en Regleta

RS3305A/9



Z-SERIES
HAND
MANUALES
TITANIUM
DE TITANIO
ACCESSORIES
ACCESORIOS
SCREWDRIVERS
DESTORNILLADORES
IMPACT
DE IMPACTO
SLEEVE-DRIVE
INDUSTRIAL
INDUSTRIALES
PROTECTOR
PROTECTORES
AUTOMOTIVE
CONSTRUCTION
CONSTRUCCION
RENEWAL KITS
JUEGOS DE HERRAMIENTAS

Hand Sockets **3/8"**

Z-SERIES
HAND MANUALES
TITANIUM DE TITANIO
ACCESSORIES ACCESORIOS
SCREWDRIVERS DESTORNILLADORES
IMPACT DE IMPACTO
SLEEVE-DRIVE
INDUSTRIAL INDUSTRIALES
PROTECTOR PROTECTORES
AUTOMOTIVE
CONSTRUCTION CONSTRUCCIÓN
RENEWAL KITS JUEGOS DE PIEZAS/REPUESTO

3310M Surface Drive Deep Sockets Vasos Surface Drive (de Contacto Curvo) Largos

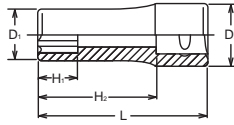

3310M (mm)	D ₁ (mm)	D ₂ (mm)	H ₁ (mm)	H ₂ (mm)	L (mm)	(g)	(pcs.)
6	9.9	17.3	7	41.5	55	37	10
7	10.6	17.3	8	41.5	55	37	10
8	12	17.3	9	41.5	55	40	10
9	13	17.3	10	41.5	55	42	10
10	14.5	17.3	11	41.5	55	46	10
11	16	17.2	12	41.5	55	51	10
12	16.8	17.2	13	41.5	55	52	10
13	18	17	14	41.5	55	53	10
14	20	18	16	41.5	55	60	10
15	21	20	16	40.5	55	74	10
16	22	20	17	40.5	55	76	10
17	23.5	22	18	40.5	55	93	10
18	24.5	23	19	39.5	55	98	10
19	25	24	20	39.5	55	98	10
20	26	25	21	49.5	65	126	10
21	27	26	22	49.5	65	126	10
22	29	28	23	48.5	65	163	10
23	30	29	24	48.5	65	168	10
24	31	30	25	47.5	65	161	10

RS3310M/12 Socket Set on Rail Juego de Vasos en Regleta



RS3310M/12	12 Pieces Set/Rail 300mm	(g)
8, 9, 10, 11, 12, 13, 14, 15, 16, 17, 18, 19		881

3300W 6-point Deep Whitworth Sockets Vasos Whitworth Hexagonales Largos

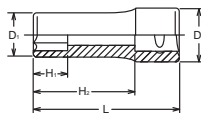

3300W 3305W (W)	D ₁ (mm)	D ₂ (mm)	H ₁ (mm)	H ₂ (mm)	L (mm)	(g)	(pcs.)
1/8	12.3	17.3	10	41.5	55	46	10
3/16	16	17.3	12	41.5	55	55	10
1/4	18	17	14	41.5	55	57	10
5/16	21	20	16	40.5	55	79	10
3/8	24.5	23	19	39.5	55	96	10
7/16	27	26	22	49.5	65	140	10
1/2	30	29	24	48.5	65	193	10
9/16	34	31	27	47.5	65	250	10

3305W 12-point Deep Whitworth Sockets Vasos Whitworth Bihexagonales Largos

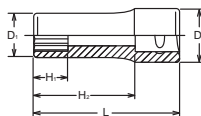

RS3300W/7 Socket Set on Rail Juego de Vasos en Regleta

RS3305W/7 Socket Set on Rail



RS3300W/7	7 Pieces Set/Rail 200mm	(g)
1/8, 3/16, 1/4, 5/16, 3/8, 7/16, 1/2		719

RS3305W/7	7 Pieces Set/Rail 200mm	(g)
1/8, 3/16, 1/4, 5/16, 3/8, 7/16, 1/2		719

BS W



BS - W	BS	3/16BS	1/4BS	5/16BS	3/8BS	7/16BS	1/2BS	9/16BS	5/8BS	11/16BS	3/4BS	7/8BS
	W	1/8W	3/16W	1/4W	5/16W	3/8W	7/16W	1/2W	9/16W	5/8W	11/16W	3/4W
Across Flat	(ref. mm)	8.64	11.30	13.34	15.24	18.03	20.83	23.37	25.65	27.94	30.48	33.35

3325 (E)	D ₁ (mm)	D ₂ (mm)	H ₁ (mm)	H ₂ (mm)	L (mm)	(g)	(pcs.)
E 4	5.6	17.3	4.6	41.5	55	29	10
E 5	6.9	17.3	5.2	41.5	55	31	10
E 6	7.9	17.3	5.4	41.5	55	33	10
E 7	8.9	17.3	6.6	41.5	55	36	10
E 8	9.9	17.3	7	41.5	55	39	10
E10	11.8	17.3	8.2	41.5	55	43	10
E12	14.5	17.2	9.3	41.5	55	53	10
E14	15.7	17.2	10.6	41.5	55	57	10
E16	18	17	11.8	41.5	55	69	10

RS3325/9	9 Pieces Set/Rail 200mm	(g)
E4, E5, E6, E7, E8, E10, E12, E14, E16		420

3325 TORX® Deep Sockets Vasos TORX® Largos



RS3325/9 Socket Set on Rail Juego de Vasos en Regleta



TORX® (E)

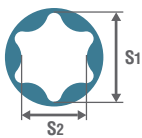

E	E4	E5	E6	E7	E8	E10	E11	E12	E14	E16	E18	E20	E22	E24	E26	E28	E30	E32
S ₁ (ref. mm)	3.7	4.6	5.6	6.1	7.4	9.3	9.9	11.0	12.8	14.6	16.5	18.3	20.1	22.0	23.7	25.5	27.3	29.0
S ₂ (ref. mm)	2.7	3.3	4.0	4.3	5.3	6.8	7.1	7.9	9.2	10.5	11.9	13.2	14.8	15.7	17.5	18.3	20.0	21.3

3350M (mm)	D ₁ (mm)	D ₂ (mm)	H ₁ (mm)	H ₂ (mm)	L (mm)	(g)	(pcs.)
8	12	17.4	5	41.5	55	50	10
10	14.5	17.4	6	41.5	55	54	10
12	16.8	17.2	7	41.5	55	58	10
13	18	17	8	41.5	55	59	10
14	19.5	18.5	8.5	41.5	55	71	10



3350M Nut Grip Deep Sockets Nut Grip® Vasos Sujeta-tuercas Largos Nut Grip®



RS3350M/5 Socket Set on Rail Juego de Vasos en Regleta



RS3350M/5	5 Pieces set/Rail 150mm	(g)
8, 10, 12, 13, 14		322

3300FN (mm)	D ₁ (mm)	D ₂ (mm)	H (mm)	L (mm)	S (mm)	(g)	(pcs.)
8	14.5	17.3	6	53	6.4	38	10
9	16	17.3	7	53	6.8	41	10
10	16.8	17.2	7.5	53	7.2	42	10
11	18	17	8.5	53	8.3	42	10
12	20	18	9	53	8.8	50	10
13	21.1	20	9.5	62	9.4	66	10
14	22	20	10.5	62	10.5	66	10
15	23	22	11	70	11.5	82	10
16	24	23	11.5	70	12	90	10
17	25	24	12.5	80	13	110	10
18	27	25	13	80	13.5	120	10
19	28	26	14	80	14.5	130	10
22	32	29.5	16	80	16	180	10
24	34.5	31.5	17	80	17	200	10

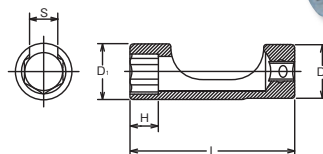

3300FN Flare Nut Sockets Llaves de vaso para entubar



RS3300FN/6 Socket Set on Rail Juego de Vasos en Regleta



RS3300FN/6	6 Pieces Set/Rail 150mm	(g)
8, 10, 12, 14, 17, 19		450

Z-SERIES
HAND
MANUALES
TITANIUM
DE TITANIO
ACCESSORIES
ACCESORIOS
SCREWDRIVERS
DESTORNILLADORES
IMPACT
DE IMPACTO
SLEEVE-DRIVE
INDUSTRIAL
INDUSTRIALES
PROTECTOR
PROTECTORES
AUTOMOTIVE
CONSTRUCTION
CONSTRUCCION
RENEWAL KITS
JUEGOS DE HERRAMIENTAS

Hand Sockets **3/8"**

Z-SERIES

HAND
MANUALES

TITANIUM
DE TITANIO

ACCESSORIES
ACCESORIOS

SCREWDRIVERS
DESTORNILLADORES

IMPACT
DE IMPACTO

SLEEVE-DRIVE

INDUSTRIAL
INDUSTRIALES

PROTECTOR
PROTECTORES

AUTOMOTIVE

CONSTRUCTION
CONSTRUCCIÓN

RENEWAL KITS
JUEGOS DE PIEZAS/REPUËSTO

3300M (L120) 6-point Extra Deep Sockets Vasos Hexagonales Extra-Largos

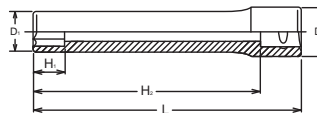

3300M-Size DEEP SOCKET



3300M-Size(L120) EXTRA DEEP SOCKET

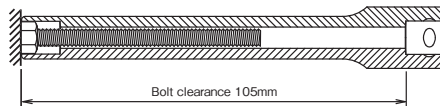

3305M (L120) 12-point Extra Deep Sockets Vasos Bihexagonales Extra-Largos



3300M(L120) 3305M(L120) (mm)	D ₁ (mm)	D ₂ (mm)	H ₁ (mm)	H ₂ (mm)	L (mm)	(g)	(pcs.)
8	12	17.3	9	106.5	120	85	10
10	14.5	17.3	11	106.5	120	110	10
12	16.8	17.2	13	106.5	120	116	10
13	18	17	14	106.5	120	155	5
14	20	18	16	106.5	120	166	5

3300M/4-L120 Socket Set Juego de Vasos

3305M/4-L120



3300M/4-L120 4 Pieces Set/△=477g

PLASTIC BAG

Sockets

3300M(L120) 6-point Extra Deep Sockets
8, 10, 12, 14

3305M/4-L120 4 Pieces Set/△=477g

PLASTIC BAG

Sockets

3305M(L120) 12-point Extra Deep Sockets
8, 10, 12, 14

3350M (L120) Extra Deep Sockets Nut Grip® Vasos Extra-Largos Nut Grip®

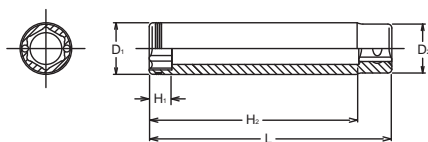

3350M(L120) (mm)	D ₁ (mm)	D ₂ (mm)	H ₁ (mm)	H ₂ (mm)	L (mm)	(g)	(pcs.)
10	14.5	17.2	6	106.5	120	110	10
12	16.8	17.2	7	106.5	120	116	10



NUT GRIP®

3350M/2-L120 Socket Set Juego de Vasos

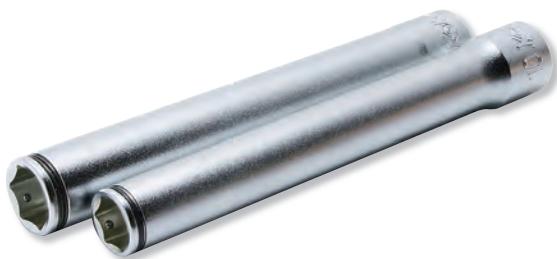

3350M/2-L120 2 Pieces Set/△=230g

PLASTIC BAG

Sockets

 3350M(L120) Nut Grip Extra Deep Sockets
10, 12

3/8" Hand Sockets

3440M 3445M (mm)	D ₁ (mm)	D ₂ (mm)	H (mm)	L (mm)	(g)	(pcs.)
8	12	19	7.3	47	50	10
9	13.3	19	7.8	47.5	50	10
10	14.5	19	8.8	48.5	64	10
11	15.8	19	9.8	49.5	66	10
12	17	19	10.3	50	67	10
13	18.3	19	11.3	51	68	10
14	19.5	19	11.3	51	69	10
15	20.8	19	12.8	53.5	70	10
16	22	19	12.8	53.5	77	10
17	23.3	19	13.8	54.5	80	10
18	24.5	19	13.8	54.5	80	10
19	25.8	19	15.8	56.5	84	10
21	28.3	19	16.8	56.5	96	10

3440A 3445A (inch)	D ₁ (mm)	D ₂ (mm)	H (mm)	L (mm)	(g)	(pcs.)
5/16	12	19	7.3	47	50	10
3/8	14	19	8.3	48	64	10
7/16	15.8	19	9.8	49.5	66	10
1/2	18.3	19	11.3	51	68	10
9/16	19.5	19	11.3	51	69	10
5/8	22	19	12.8	53.5	77	10
11/16	24.5	19	13.8	54.5	80	10
3/4	25.8	19	15.8	56.5	84	10

RS3440M/8	8 Pieces Set/Rail 200mm	(g)
8, 10, 11, 12, 13, 14, 17, 19		550

RS3440A/8	8 Pieces Set/Rail 200mm	(g)
5/16, 3/8, 7/16, 1/2, 9/16, 5/8, 11/16, 3/4		570

3445W (W)	D ₁ (mm)	D ₂ (mm)	H (mm)	L (mm)	(g)	(pcs.)
1/8	13.3	19	7.8	47.5	50	10
3/16	15.8	19	9.7	49.5	66	10
1/4	18.3	19	11.3	51	68	10
5/16	20.8	19	12.8	53.5	70	10
3/8	24.5	19	13.8	54.5	80	10
7/16	28.3	19	16.8	57.5	96	10
1/2	30.8	19	17.8	58.5	105	10

RS3445W/7	7 Pieces Set/Rail 200mm	(g)
1/8, 3/16, 1/4, 5/16, 3/8, 7/16, 1/2		570

3440T (E)	D ₁ (mm)	D ₂ (mm)	H (mm)	L (mm)	(g)	(pcs.)
E 6	7.9	19	5.4	44.9	60	10
E 8	9.9	19	7	46.5	63	10
E10	11.8	19	8.2	47.7	63	10
E12	14.5	19	9.3	48.8	68	10
E14	15.7	19	10.6	50.1	68	10
E16	18	19	11.8	51.3	70	10
E18	19.5	19	13	53.5	78	10
E20	22	19	14.4	54.9	81	10

RS3440T/8	8 Pieces Set/Rail 200mm	(g)
E6, E8, E10, E12, E14, E16, E18, E20		594

3440M • 3440A 6-point Universal Sockets Vasos Hexagonales Universal

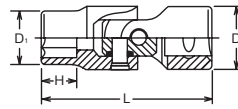

3445M • 3445A 12-point Universal Sockets Vasos Bihexagonales con Articulación Universal

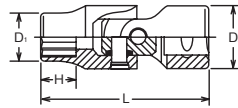

RS3440M/8 Socket Set on Rail Juego de Vasos en Regleta

RS3440A /8



3445W 12-point Whitworth Universal Socket Vasos Whitworth Bihex con Articulación Universal

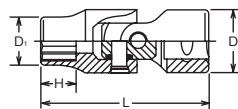

RS3445W/7 Socket Set on Rail Juego de Vasos en Regleta



3440T TORX® Universal Sockets Vasos TORX® con Articulación Universal

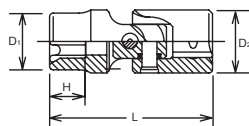

RS3440T/8 Socket Set on Rail Juego de Vasos en Regleta



TORX® (E)

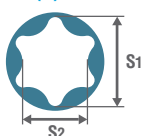

E	E4	E5	E6	E7	E8	E10	E11	E12	E14	E16	E18	E20	E22	E24	E26	E28	E30	E32
S ₁ (ref. mm)	3.7	4.6	5.6	6.1	7.4	9.3	9.9	11.0	12.8	14.6	16.5	18.3	20.1	22.0	23.7	25.5	27.3	29.0
S ₂ (ref. mm)	2.7	3.3	4.0	4.3	5.3	6.8	7.1	7.9	9.2	10.5	11.9	13.2	14.8	15.7	17.5	18.3	20.0	21.3

Hand Sockets **3/8"**

Z-SERIES
HAND
MANUALES

TITANIUM
DE TITANIO

ACCESSORIES
ACCESORIOS

SCREWDRIVERS
DESTORNILLADORES

IMPACT
DE IMPACTO

SLEEVE-DRIVE
MANGUITO

INDUSTRIAL
INDUSTRIALES

PROTECTOR
PROTECTORES

AUTOMOTIVE

CONSTRUCTION
CONSTRUCCIÓN

RENEWAL KITS
JUEGOS DE PIEZAS REPUESTO

3441M Nut Grip Universal Sockets **Nut Grip®** Vasos Sujeta-Tuercas con Articulación Universal

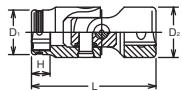

3441M (mm)	D ₁ (mm)	D ₂ (mm)	H (mm)	L (mm)	(g)	(pcs.)
8	12	19	5	46	57	10
10	14.5	19	6	46	58	10
12	16.8	19	7	47	58	10
13	18	19	8	48	60	10
14	19.5	19	8.5	49.5	65	10

RS3441M/5 Socket Set on Rail Juego de Vasos en Regleta



RS3441M/5	5 Pieces Set/Rail 150mm	(g)
8, 10, 12, 13, 14		320

3340M-75 Universal Deep Sockets Vasos Largos con Articulación Universal

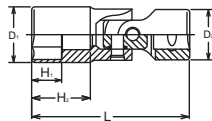

3340M.75 (mm)	D ₁ (mm)	D ₂ (mm)	H ₁ (mm)	H ₂ (mm)	L (mm)	(g)	(pcs.)
8	12	19	9	39	75	82	10
10	14.5	19	11	39	75	87	10
11	15.8	19	12	39	75	87	10
12	17	19	13	39	75	92	10
13	18.3	19	14	36	75	93	10
14	19.5	19	15	35	75	103	10
15	20.8	19	16	35	75	104	10
16	22	19	17	34	75	110	10
17	23.3	19	18	34	75	115	10
18	24.5	19	19	34	75	119	10
19	25.8	19	20	33	75	123	10

RS3340M/8-L75 Socket Set on Rail Juego de Vasos en Regleta



RS3340M/8-L75	8 Pieces Set/Rail 200mm	(g)
8, 10, 11, 12, 13, 14, 17, 19		810

3430M Universal Inhex Bit Sockets Vasos Inhex con Articulación Universal

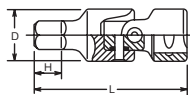

3430M (mm)	D (mm)	H (mm)	L (mm)	(g)	(pcs.)
5	19	15.5	62	66	10
6	19	15.5	62	70	10
7	19	15.5	62	72	10
8	19	15.5	62	74	10
10	19	15.5	62	78	10
12	19	15.5	62	85	10

RS3430M/6 Socket Set on Rail Juego de Vasos en Regleta



RS3430M/6	6 Pieces Set/Rail 150mm	(g)
5, 6, 7, 8, 10, 12		470

3117M-125 • -250 Extension Deep Sockets Vasos con Alargadera

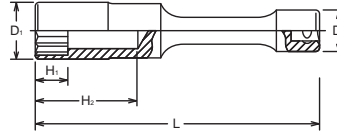

3117M.125 (mm)	D ₁ (mm)	D ₂ (mm)	H ₁ (mm)	H ₂ (mm)	L (mm)	(g)	(pcs.)
10	14.5	18	10	44	125	121	1
11	16	18	11	44	125	133	1
12	17	18	12	44	125	133	1
13	18	18	13	44	125	134	1
14	19.5	18	14	44	125	145	1
17	23.5	18	17	44	125	178	1
19	25	18	19	44	125	187	1
21	27	18	21	44	125	195	1
22	29	18	22	44	125	214	1

3117M.250 (mm)	D ₁ (mm)	D ₂ (mm)	H ₁ (mm)	H ₂ (mm)	L (mm)	(g)	(pcs.)
10	14.5	18	10	44	250	233	1
11	16	18	11	44	250	241	1
12	17	18	12	44	250	246	1
13	18	18	13	44	250	249	1
14	19.5	18	14	44	250	262	1
17	23.5	18	17	44	250	289	1
19	25	18	19	44	250	298	1
21	27	18	21	44	250	302	1
22	29	18	22	44	250	325	1

3000 (PH)	D (mm)	H (mm)	L (mm)	(g)	(pcs.)
1	18	33.5	60	49	10
2	18	33.5	60	49	10
3	18	33.5	60	49	10
4	18	33.5	60	50	10

3000-60 (PH)

 Phillips Bit Sockets
Vasos con Punta Phillips

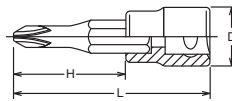

3000.50 (PZ)	D (mm)	H (mm)	L (mm)	(g)	(pcs.)
PZ1	18	23.5	50	50	10
PZ2	18	23.5	50	50	10
PZ3	18	23.5	50	50	10

3000-50 (PZ)

 PZ Bit Sockets
Vasos con Punta PZ

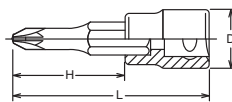







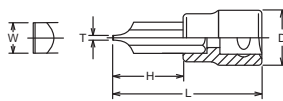







3005	TxW (mm)	D (mm)	H (mm)	L (mm)	(g)	(pcs.)
5	1.0x 5.5	18	33.5	60	47	10
8	1.2x 8	18	33.5	60	49	10
10	1.6x10	20	33.5	60	85	10

3005-60

 Slotted Bit Sockets
Vasos con Punta Recta para Cabeza Ranurada



	 Phillips (PH)	 PZ	 Slotted	 HEX	 HEX (ball point)	 Triple Square (XZN)	 TORX® (T)	 TORX® (TH)	 TORXPLUS® (IP)	 TORXPLUS® (IPR)	 Ribe-CV
 1/4"	No.2000 series	No.2000(PZ) series	No.2005 series	No.2010M/A series	No.2011M series	No.2020 series	No.2025 series	No.2025(TH) series	No.2025(IP) series	No.2025(IPR) series	—
 3/8"	No.3000 No.3001 series	No.3000(PZ) series	No.3005 No.3006 series	No.3010M/A No.3012M/A No.3015M series	No.3011M series	No.3020 series	No.3025 series	No.3025(TH) series	No.3025(IP) series	No.3025(IPR) series	No.3027 series
 1/2"	No.4000 No.4001 series	No.4000(PZ) series	No.4005 No.4006 series	No.4010M/A No.4012M/A series	—	No.4020 series	No.4025 series	—	No.4025(IP) series	—	No.4027 series

Z-SERIES
HAND
MANUALES
TITANIUM
DE TITANIO
ACCESSORIES
ACCESORIOS
SCREWDRIVERS
DESTORNILLADORES
DE IMPACTO
SLEEVE-DRIVE
INDUSTRIAL
PROTECTOR
AUTOMOTIVE
CONSTRUCTION
RENEWAL KITS

Hand Sockets **3/8"**

Z-SERIES
HAND
MANUALES
TITANIUM
DE TITANIO
ACCESSORIES
ACCESORIOS
IMPACT
DE IMPACTO
SLEEVE-DRIVE
INDUSTRIAL
INDUSTRIALES
PROTECTOR
PROTECTORES
AUTOMOTIVE
CONSTRUCTION
CONSTRUCCIÓN
RENEWAL KITS
JUEGOS DE PIEZAS REPUÉSTO

3010M-38 · -62 · -100 · -160 3010A-50

 Inhex Bit Sockets
Vasos con Punta Hexagonal

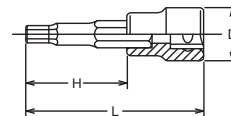
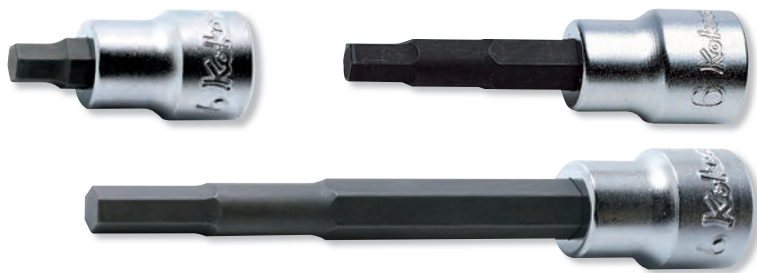

3010M.38 (mm)	D (mm)	H (mm)	L (mm)	(g)	(pcs.)
3	18	11.5	38	27	10
4	18	11.5	38	28	10
5	18	11.5	38	30	10
6	18	11.5	38	31	10
7	18	11.5	38	32	10
8	18	11.5	38	33	10
9	20	11.5	38	47	10
10	20	11.5	38	48	10
11	20	11.5	38	59	10
12	20	11.5	38	60	10
13	22	11.5	38	76	5
14	22	11.5	38	78	5

3010M.62 (mm)	D (mm)	H (mm)	L (mm)	(g)	(pcs.)
3	18	35.5	62	43	10
4	18	35.5	62	45	10
5	18	35.5	62	48	10
6	18	35.5	62	49	10
7	18	35.5	62	50	10
8	18	35.5	62	62	10
9	20	35.5	62	75	10
10	20	35.5	62	76	10
11	20	35.5	62	92	10
12	20	35.5	62	94	10
13	22	35.5	62	107	5
14	22	35.5	62	109	5

3010M.100 (mm)	D (mm)	H (mm)	L (mm)	(g)	(pcs.)
3	18	73.5	100	58	10
4	18	73.5	100	60	10
5	18	73.5	100	63	10
6	18	73.5	100	64	10
7	18	73.5	100	66	10
8	18	73.5	100	69	10
9	20	73.5	100	100	10
10	20	73.5	100	102	10
11	20	73.5	100	129	10
12	20	73.5	100	131	10
13	22	73.5	100	158	5
14	22	73.5	100	160	5

3010M.160 (mm)	D (mm)	H (mm)	L (mm)	(g)	(pcs.)
3	18	133.5	160	84	10
4	18	133.5	160	86	10
5	18	133.5	160	89	10
6	18	133.5	160	90	10
7	18	133.5	160	92	10
8	18	133.5	160	95	10
9	20	133.5	160	125	10
10	20	133.5	160	128	10
11	20	133.5	160	153	10
12	20	133.5	160	157	10
13	22	133.5	160	237	5
14	22	133.5	160	239	5

3010A.50 (inch)	D (mm)	H (mm)	L (mm)	(g)	(pcs.)
1/8	18	23.5	50	35	10
5/32	18	23.5	50	36	10
3/16	18	23.5	50	36	10
7/32	18	23.5	50	38	10
1/4	18	23.5	50	40	10
9/32	18	23.5	50	42	10
5/16	18	23.5	50	44	10
11/32	20	23.5	50	59	10
3/8	20	23.5	50	60	10
7/16	20	23.5	50	74	10
1/2	22	23.5	50	91	5

RS3010M/8-L38 Socket Set on Rail Juego de Vasos en Regleta

RS3010M/8-L62

RS3010M/8-L100

RS3010A/8-L50



RS3010M/8-L38	8 Pieces Set/Rail 200mm	(g)
3, 4, 5, 6, 7, 8, 10, 12		322
RS3010M/8-L62	8 Pieces Set/Rail 200mm	(g)
3, 4, 5, 6, 7, 8, 10, 12		490
RS3010M/8-L100	8 Pieces Set/Rail 200mm	(g)
3, 4, 5, 6, 7, 8, 10, 12		645
RS3010A/8-L50	8 Pieces Set/Rail 200mm	(g)
1/8, 5/32, 3/16, 7/32, 1/4, 5/16, 3/8, 1/2		400

3/8" Hand Sockets

3012M.25 (mm)	D (mm)	H ₁ (mm)	H ₂ (mm)	L (mm)	(g)	(pcs.)
3	18.5	5.5	10	25	22	10
4	18.5	5.5	10	25	22	10
5	18.5	6.5	10	25	22	10
6	18.5	7.5	10	25	23	10
7	18.5	10	-	25	24	10
8	18.5	10	-	25	25	10
10	18.5	10	-	25	27	10
12	18.5	10	-	25	30	10
14	19	10	-	25	30	10
17	19	10	-	25	30	10

3012M-25

Inhex Sockets
Vasos con Punta de Hexagonal

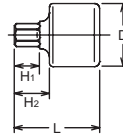

3012M-52 · -62 · -75

Inhex Sockets
Vasos con Punta de Hexagonal

3012A-52 · -62 · -75

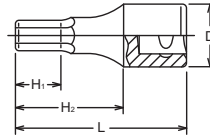

3012M/A are for hand use only.
Do not use with a power or impact wrench.

3012M.52 (mm)	D (mm)	H ₁ (mm)	H ₂ (mm)	L (mm)	(g)	(pcs.)
3	18	10	34	52	35	10
4	18	15.5	34	52	38	10
5	18	15.5	34	52	40	10
6	18	15.5	34	52	42	10
7	18	15.5	34	52	46	10
8	18.5	15.5	34	52	50	10
9	18.5	15.5	34	52	55	10
10	20	15.5	34	52	66	10
11	20	15.5	34	52	72	10
12	20	15.5	34	52	77	10
13	20	15.5	34	52	82	10
14	20	15.5	34	52	89	10

3012A.52 (inch)	D (mm)	H ₁ (mm)	H ₂ (mm)	L (mm)	(g)	(pcs.)
1/8	18	10	34	52	35	10
5/32	18	15.5	34	52	38	10
3/16	18	15.5	34	52	40	10
7/32	18	15.5	34	52	42	10
1/4	18	15.5	34	52	44	10
9/32	18	15.5	34	52	46	10
5/16	18.5	15.5	34	52	50	10
11/32	18.5	15.5	34	52	55	10
3/8	20	15.5	34	52	65	10
7/16	20	15.5	34	52	72	10
1/2	20	15.5	34	52	82	10
9/16	20	15.5	34	52	89	10

3012M.62 (mm)	D (mm)	H ₁ (mm)	H ₂ (mm)	L (mm)	(g)	(pcs.)
3	18	10	44	62	38	10
4	18	15.5	44	62	40	10
5	18	15.5	44	62	43	10
6	18	15.5	44	62	46	10
7	18	15.5	44	62	53	10
8	18.5	15.5	44	62	58	10
9	18.5	15.5	44	62	63	10
10	20	15.5	44	62	77	10
11	20	15.5	44	62	83	10
12	20	15.5	44	62	90	10
13	20	15.5	44	62	95	10
14	20	15.5	44	62	109	10

3012A.62 (inch)	D (mm)	H ₁ (mm)	H ₂ (mm)	L (mm)	(g)	(pcs.)
1/8	18	10	44	62	38	10
5/32	18	15.5	44	62	40	10
3/16	18	15.5	44	62	43	10
7/32	18	15.5	44	62	46	10
1/4	18	15.5	44	62	48	10
9/32	18	15.5	44	62	53	10
5/16	18.5	15.5	44	62	58	10
11/32	18.5	15.5	44	62	63	10
3/8	20	15.5	44	62	73	10
7/16	20	15.5	44	62	83	10
1/2	20	15.5	44	62	95	10
9/16	20	15.5	44	62	109	10

3012M.75 (mm)	D (mm)	H ₁ (mm)	H ₂ (mm)	L (mm)	(g)	(pcs.)
3	18	10	57	75	41	10
4	18	15.5	57	75	43	10
5	18	15.5	57	75	48	10
6	18	15.5	57	75	53	10
7	18	15.5	57	75	58	10
8	18.5	15.5	57	75	72	10
9	18.5	15.5	57	75	92	10
10	20	15.5	57	75	114	10
11	20	15.5	57	75	120	10
12	20	15.5	57	75	127	10
13	20	15.5	57	75	132	10
14	20	15.5	57	75	146	10

3012A.75 (inch)	D (mm)	H ₁ (mm)	H ₂ (mm)	L (mm)	(g)	(pcs.)
1/8	18	10	57	75	41	10
5/32	18	15.5	57	75	43	10
3/16	18	15.5	57	75	48	10
7/32	18	15.5	57	75	53	10
1/4	18	15.5	57	75	53	10
9/32	18	15.5	57	75	58	10
5/16	18.5	15.5	57	75	72	10
11/32	18.5	15.5	57	75	92	10
3/8	20	15.5	57	75	110	10
7/16	20	15.5	57	75	120	10
1/2	20	15.5	57	75	132	10
9/16	20	15.5	57	75	146	10

RS3012M/8-L52	8 Pieces Set/Rail 200mm	(g)
3, 4, 5, 6, 7, 8, 10, 12		394

RS3012A/8-L52	8 Pieces Set/Rail 200mm	(g)
1/8, 5/32, 3/16, 7/32, 1/4, 5/16, 3/8, 1/2		425

RS3012M/8-L52

Socket Set on Rail
Juego de Vasos en Regleta

RS3012A/8-L52



Z-SERIES
HAND
MANUALES
TITANIUM
DE TITANIO
ACCESSORIES
ACCESORIOS
SCREWDRIVERS
DESTORNILLADORES
IMPACT
DE IMPACTO
SLEEVE-DRIVE
INDUSTRIAL
INDUSTRIALES
PROTECTOR
PROTECTORES
AUTOMOTIVE
CONSTRUCTION
CONSTRUCCION
RENEWAL KITS
JUEGOS DE HERRAMIENTAS

Z-SERIES

HAND
MANUALESTITANIUM
DE TITANIOACCESSORIES
ACCESORIOSSCREWDRIVERS
DESTORNILLADORESIMPACT
DE IMPACTO

SLEEVE-DRIVE

INDUSTRIAL
INDUSTRIALESPROTECTOR
PROTECTORES

AUTOMOTIVE

CONSTRUCTION
CONSTRUCCIÓNRENEWAL KITS
JUEGOS DE PIEZAS REPUESTO

3011M-62 · -100 · -120 · -160

Ballpoint Inhex Sockets
Vasos con Punta de Bola Inhex ⚠

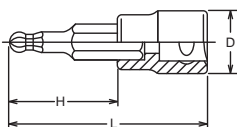

3011M.62 (mm)	D (mm)	H (mm)	L (mm)	(g)	(pcs.)
3	18	35.5	62	45	10
4	18	35.5	62	46	10
5	18	35.5	62	48	10
6	18	35.5	62	49	10
7	18	35.5	62	50	10
8	18	35.5	62	51	10
10	20	35.5	62	66	10
12	20	35.5	62	79	10

3011M.100 (mm)	D (mm)	H (mm)	L (mm)	(g)	(pcs.)
3	18	73.5	100	61	10
4	18	73.5	100	62	10
5	18	73.5	100	64	10
6	18	73.5	100	65	10
7	18	73.5	100	67	10
8	18	73.5	100	68	10

3011M.120 (mm)	D (mm)	H (mm)	L (mm)	(g)	(pcs.)
3	18	93.5	120	77	10
4	18	93.5	120	78	10
5	18	93.5	120	80	10
6	18	93.5	120	81	10
7	18	93.5	120	83	10
8	18	93.5	120	84	10

3011M.160 (mm)	D (mm)	H (mm)	L (mm)	(g)	(pcs.)
3	18	133.5	160	87	10
4	18	133.5	160	88	10
5	18	133.5	160	89	10
6	18	133.5	160	91	10
7	18	133.5	160	93	10
8	18	133.5	160	95	10

⚠ Ball point bit sockets have less strength due to the special design. Make sure to use them correctly.

3015M-62 · -100

Inhex Bit Sockets, Grip Ring
Vasos con Punta Hexagonal, Grip Ring ⚠

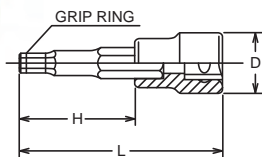

3015M.62 (mm)	D (mm)	H (mm)	L (mm)	(g)	(pcs.)
3	18	35.5	62	43	10
4	18	35.5	62	45	10
5	18	35.5	62	50	10
6	18	35.5	62	50	10
7	18	35.5	62	50	10
8	18	35.5	62	62	10
10	20	35.5	62	75	10
12	20	35.5	62	95	10

3015M.100 (mm)	D (mm)	H (mm)	L (mm)	(g)	(pcs.)
3	18	73.5	100	60	10
4	18	73.5	100	60	10
5	18	73.5	100	65	10
6	18	73.5	100	65	10
7	18	73.5	100	70	10
8	18	73.5	100	70	10
10	20	73.5	100	105	10
12	20	73.5	100	135	10

Grip Ring holds hex screws

⚠ 3015M have less load capacity than standard. It must be used with proper engagement and apply load evenly to avoid breakage.

RS3015M/8-L62

Socket Set on Rail
Juego de Vasos en Regleta

RS3015M/8-L100



RS3015M/8-L62	8 Pieces Set/Rail 200mm	(g)
3, 4, 5, 6, 7, 8, 10, 12		500

RS3015M/8-L100	8 Pieces Set/Rail 200mm	(g)
3, 4, 5, 6, 7, 8, 10, 12		650

3/8" Hand Sockets

3020.38 (XZN)	D (mm)	d (mm)	H (mm)	L (mm)	(g)	(pcs.)
M 5	18	7.8	11.5	38	32	10
M 6	18	7.8	11.5	38	33	10
M 8	18	7.8	11.5	38	36	10
M10	20	11.9	11.5	38	51	10
M12	20	11.9	11.5	38	52	10
M14	22	13.9	11.5	38	74	10

3020.50 (XZN)	D (mm)	d (mm)	H (mm)	L (mm)	(g)	(pcs.)
M 4	18	7.8	23.5	50	35	10
M 5	18	7.8	23.5	50	37	10
M 6	18	7.8	23.5	50	39	10
M 8	18	7.8	23.5	50	40	10
M10	20	11.9	23.5	50	65	10
M12	20	11.9	23.5	50	69	10
M14	22	13.9	23.5	50	75	10

3020.100 (XZN)	D (mm)	d (mm)	H (mm)	L (mm)	(g)	(pcs.)
M 4	18	7.8	73.5	100	57	10
M 5	18	7.8	73.5	100	59	10
M 6	18	7.8	73.5	100	61	10
M 8	18	7.8	73.5	100	62	10
M10	20	11.9	73.5	100	99	10
M12	20	11.9	73.5	100	103	10
M14	22	13.9	73.5	100	145	5

3020.120 (XZN)	D (mm)	d (mm)	H (mm)	L (mm)	(g)	(pcs.)
M 4	18	7.8	93.5	120	77	10
M 5	18	7.8	93.5	120	79	10
M 6	18	7.8	93.5	120	81	10
M 8	18	7.8	93.5	120	82	10
M10	20	11.9	93.5	120	119	10
M12	20	11.9	93.5	120	123	10
M14	22	13.9	93.5	120	165	5

RS3020/6-L38	6 Pieces Set/Rail 150mm	(g)
M5, M6, M8, M10, M12, M14		308

RS3020/7-L50	7 Pieces Set/Rail 200mm	(g)
M4, M5, M6, M8, M10, M12, M14		400

3020-38 · -50 · -100 · -120 XZN Bit Sockets Vasos con punta XZN

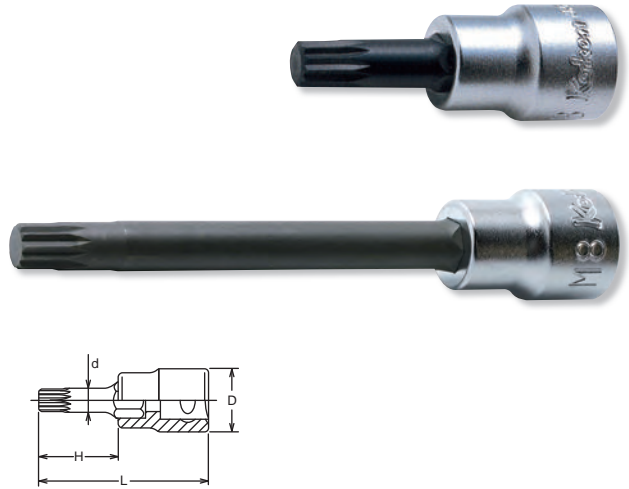

RS3020/6-L38 Socket Set on Rail Juego de Vasos en Regleta



RS3020/7-L50 Socket Set on Rail Juego de Vasos en Regleta



XZN		M4	M5	M6	M8	M10	M12	M14	M16	M18
S ₁	(ref. mm)	3.6	4.8	6.1	7.3	9.7	11.5	13.3	15.7	16.9
S ₂	(ref. mm)	3.1	4.1	5.1	6.1	8.1	9.7	11.2	13.2	14.2

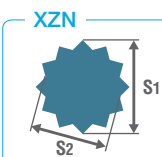

Z-SERIES
HAND
MANUALES
TITANIUM
DE TITANIO
ACCESSORIES
ACCESORIOS
SCREWDRIVERS
DESTORNILLADORES
IMPACT
DE IMPACTO
SLEEVE-DRIVE
INDUSTRIAL
INDUSTRIALES
PROTECTOR
PROTECTORES
AUTOMOTIVE
CONSTRUCTION
CONSTRUCCION
RENEWAL KITS
JUEGOS DE HEZAS/REPUESTO

Hand Sockets 3/8"

Z-SERIES
HAND
MANUALES

TITANIUM
DE TITANIO

ACCESSORIES
ACCESORIOS

SCREWDRIVERS
DESTORNILLADORES

IMPACT
DE IMPACTO

SLEEVE-DRIVE
INDUSTRIAL

INDUSTRIAL
INDUSTRIALES

PROTECTOR
PROTECTORES

AUTOMOTIVE

CONSTRUCTION
CONSTRUCCIÓN

RENEWAL KITS
JUEGOS DE PIEZAS/REPUËSTO

3025-38 · -50 · -140 (T)

TORX® Bit Sockets
Vasos con Punta TORX®

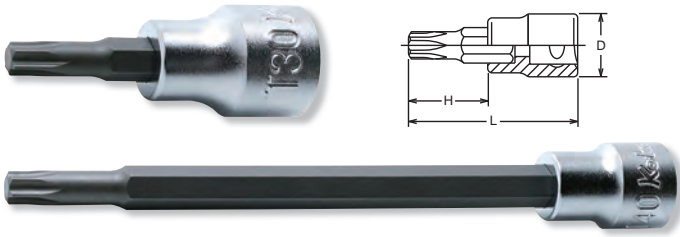

3025.50 (T)	D (mm)	H (mm)	L (mm)	(g)	(pcs.)
T 8	18	23.5	50	36	10
T 9	18	23.5	50	36	10
T10	18	23.5	50	36	10
T15	18	23.5	50	36	10
T20	18	23.5	50	36	10
T25	18	23.5	50	37	10
T27	18	23.5	50	37	10
T30	18	23.5	50	38	10
T40	18	23.5	50	39	10
T45	18	23.5	50	41	10
T50	20	23.5	50	55	10
T55	20	23.5	50	67	10

3025.38 (T)	D (mm)	H (mm)	L (mm)	(g)	(pcs.)
T 8	18	11.5	38	32	10
T 9	18	11.5	38	32	10
T10	18	11.5	38	32	10
T15	18	11.5	38	33	10
T20	18	11.5	38	33	10
T25	18	11.5	38	33	10
T27	18	11.5	38	33	10
T30	18	11.5	38	33	10
T40	18	11.5	38	34	10
T45	18	11.5	38	37	10
T50	20	11.5	38	49	10
T55	20	11.5	38	57	10

3025.140 (T)	D (mm)	H (mm)	L (mm)	(g)	(pcs.)
T 9	18	113.5	140	75	10
T10	18	113.5	140	75	10
T15	18	113.5	140	75	10
T20	18	113.5	140	75	10
T25	18	113.5	140	76	10
T27	18	113.5	140	76	10
T30	18	113.5	140	77	10
T40	18	113.5	140	78	10
T45	18	113.5	140	80	10
T50	20	113.5	140	94	10
T55	20	113.5	140	106	10

RS3025/8-L38



Socket Set on Rail
Juego de Vasos en Regleta

RS3025/8-L50



RS3025/8-L38	8 Pieces Set/Rail 200mm	(g)
T10, T15, T20, T25, T27, T30, T40, T45		300

RS3025/8-L50	8 Pieces Set/Rail 200mm	(g)
T10, T15, T20, T25, T27, T30, T40, T45		320

TORX®
(T)

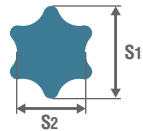

T	T8	T9	T10	T15	T20	T25	T27	T30	T40	T45	T50	T55	T60	T70	T80	T90	T100
S ₁ (ref. mm)	2.3	2.5	2.7	3.3	3.9	4.5	5.0	5.6	6.7	7.9	8.9	11.3	13.3	15.6	17.6	20.0	22.2
S ₂ (ref. mm)	1.7	1.8	2.0	2.3	2.8	3.2	3.6	4.0	4.8	5.6	6.2	8.0	9.5	11.1	12.7	14.2	15.8

3025-50-T35

Bit Socket
Vasos con Punta



3025.50	D (mm)	H (mm)	L (mm)	(g)	(pcs.)
T35	18	23.5	50	39	10

3025-100R (T)

TORX® Bit Sockets, Round Shaft
Vasos con Punta TORX®



3025.100R (T)	D (mm)	d (mm)	H (mm)	L (mm)	(g)	(pcs.)
T20	18	4	73.5	100	38	10
T25	18	4.6	73.5	100	40	10
T27	18	5.2	73.5	100	42	10
T30	18	5.7	73.5	100	45	10
T40	18	6.8	73.5	100	52	10
T45	20	8	73.5	100	73	10
T50	20	9	73.5	100	80	10
T55	20	11.4	73.5	100	106	10

RS3025/8-L100R



Socket Set on Rail
Juego de Vasos en Regleta

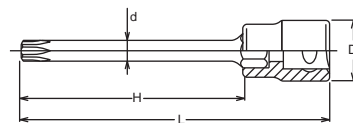

RS3025/8-L100R	8 Pieces Set/Rail 200mm	(g)
T20, T25, T27, T30, T40, T45, T50, T55		490

3025.50 (TH)	D (mm)	H (mm)	L (mm)	(g)	(pcs.)
T10H	18	23.5	50	37	10
T15H	18	23.5	50	38	10
T20H	18	23.5	50	38	10
T25H	18	23.5	50	38	10
T27H	18	23.5	50	38	10
T30H	18	23.5	50	39	10
T40H	18	23.5	50	40	10
T45H	18	23.5	50	41	10
T50H	20	23.5	50	61	10
T55H	20	23.5	50	61	10

3025.160 (TH)	D (mm)	H (mm)	L (mm)	(g)	(pcs.)
T25H	18	133.5	160	83	10
T27H	18	133.5	160	83	10
T30H	18	133.5	160	84	10
T40H	18	133.5	160	85	10
T45H	18	133.5	160	86	10
T50H	20	133.5	160	128	10
T55H	20	133.5	160	128	10

RS3025/9-HOLE	9 Pieces Set/Rail 200mm	(g)
T10H, T15H, T20H, T25H, T27H, T30H, T40H, T45H, T50H		405

3247	4 Pieces Set/385g
Sockets	
3025.160 Tamper-Resistant TORX® Bit Sockets T27H, T30H, T40H, T50H	

3025.100R (TH)	D (mm)	d (mm)	H (mm)	L (mm)	(g)	(pcs.)
T20H	18	4	73.5	100	38	10
T25H	18	4.6	73.5	100	40	10
T27H	18	5.2	73.5	100	42	10
T30H	18	5.7	73.5	100	45	10
T40H	18	6.8	73.5	100	52	10
T45H	20	8	73.5	100	73	10
T50H	20	9	73.5	100	80	10
T55H	20	11.4	73.5	100	106	10

RS3025/8-L100RH	8 Pieces Set/Rail 200mm	(g)
T20H, T25H, T27H, T30H, T40H, T45H, T50H, T55H		490

3025-50 · -160 (TH) ⚠

Tamper-Resistant TORX® Bit Sockets
Vasos con Punta TORX® Indeflexible

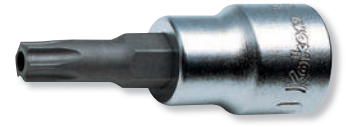
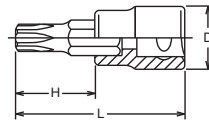

⚠ Tamper Resistant TORX® Bit Sockets have less strength due to special design. Make sure to use it correctly.

Los Vasos con Punta Indeflexible TORX® tienen menos resistencia debido al diseño especial. Asegurarse de su correcta utilización.

RS3025/9-HOLE Socket Set on Rail Juego de Vasos en Regleta



3247 Bit Socket Set Juego de Vasos con Punta



3025-100R (TH) Tamper-Resistant TORX® Bit Sockets, Round Shaft Vasos con Punta TORX® Indeflexible

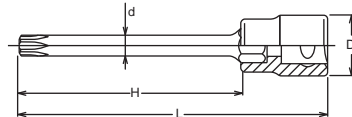

RS3025/8-L100RH Socket Set on Rail Juego de Vasos en Regleta



Z-SERIES
HAND
MANUALES
TITANIUM
DE TITANIO
ACCESSORIES
ACCESORIOS
SCREWDRIVERS
DESTORNILLADORES
IMPACT
DE IMPACTO
SLEEVE-DRIVE
INDUSTRIAL
INDUSTRIALES
PROTECTOR
PROTECTORES
AUTOMOTIVE
CONSTRUCTION
CONSTRUCCION
RENEWAL KITS
JUEGOS DE HERRAMIENTAS

Hand Sockets 3/8"

Z-SERIES
HAND
MANUALES

3025-50 (IP)

 TORXPLUS® Bit Sockets
Vasos con Punta TORXPLUS®

TORXplus®

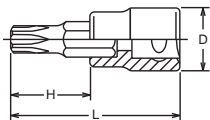

3025.50 (IP)	D (mm)	H (mm)	L (mm)	(g)	(pcs.)
10IP	18	23.5	50	38	10
15IP	18	23.5	50	38	10
20IP	18	23.5	50	38	10
25IP	18	23.5	50	38	10
27IP	18	23.5	50	40	10
30IP	18	23.5	50	40	10
40IP	18	23.5	50	41	10
45IP	18	23.5	50	41	10
50IP	20	23.5	50	61	10
55IP	20	23.5	50	61	10

RS3025/8-IP

  Socket Set on Rail
Juego de Vasos en Regleta



RS3025/8-IP	8 Pieces Set/Rail 200mm	(g)
20IP, 25IP, 27IP, 30IP, 40IP, 45IP, 50IP, 55IP		370

RSX025/11-IP

  Socket Set on Rail
Juego de Vasos en Regleta



RSX025/11-IP	11 Pieces Set/Rail 200mm	(g)
2025.28(IP)	10IP, 15IP, 20IP, 25IP, 27IP	480
3025.50(IP)	30IP, 40IP, 45IP, 50IP	
4025.60(IP)	55IP, 60IP	

$\boxed{1/4"} + \boxed{3/8"} + \boxed{1/2"}$

TORXPLUS® (IP)

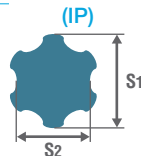

IP	8IP	9IP	10IP	15IP	20IP	25IP	27IP	30IP	40IP	45IP	50IP	55IP	60IP	70IP
S ₁ (ref. mm)	2.3	2.5	2.7	3.3	3.9	4.5	5.0	5.6	6.7	7.9	8.9	11.3	13.3	15.6
S ₂ (ref. mm)	1.7	1.8	2.0	2.3	2.8	3.2	3.6	4.0	4.8	5.6	6.2	8.0	9.5	11.1

TITANIUM
DE TITANIO

ACCESSORIES
ACCESORIOS

SCREWDRIVERS
DESTORNILLADORES

IMPACT
DE IMPACTO

SLEEVE-DRIVE
INDUSTRIAL

INDUSTRIAL
INDUSTRIALES

PROTECTOR
PROTECTORES

AUTOMOTIVE

CONSTRUCTION
CONSTRUCCIÓN

RENEWAL KITS
JUEGOS DE PIEZAS/REPUSTO

3025-50 (IPR)

 TORXPLUS® Bit Sockets, with Hole
Vasos con Punta de Cinco Lóbulos, con agujero

TORXplus®

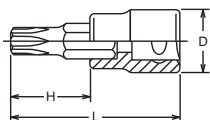

3025.50 (IPR)	D (mm)	H (mm)	L (mm)	(g)	(pcs.)
10IPR	18	23.5	50	38	10
15IPR	18	23.5	50	38	10
20IPR	18	23.5	50	38	10
25IPR	18	23.5	50	38	10
27IPR	18	23.5	50	40	10
30IPR	18	23.5	50	40	10
40IPR	18	23.5	50	41	10
45IPR	18	23.5	50	41	10
50IPR	20	23.5	50	61	10
55IPR	20	23.5	50	61	10



RS3025/9-IPR

  Socket Set on Rail
Juego de Vasos en Regleta



RS3025/9-IPR	9 Pieces Set/Rail 200mm	(g)
10IPR, 15IPR, 20IPR, 25IPR, 27IPR, 30IPR, 40IPR, 45IPR, 50IPR		395

RSX025/11-IPR

  Socket Set on Rail
Juego de Vasos en Regleta



RSX025/11-IPR	11 Pieces Set/Rail 200mm	(g)
2025.28(IPR)	8IPR, 10IPR, 15IPR, 20IPR, 25IPR, 27IPR, 30IPR	320
3025.50(IPR)	40IPR, 45IPR, 50IPR, 55IPR	

$\boxed{1/4"} + \boxed{3/8"}$

TORXPLUS® (IPR)

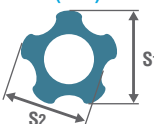

IPR	8IPR	9IPR	10IPR	15IPR	20IPR	25IPR	27IPR	30IPR	40IPR	45IPR	50IPR	55IPR
S ₁ (ref. mm)	2.2	2.4	2.6	3.1	3.6	4.1	4.7	5.2	6.3	7.4	8.4	10.6
S ₂ (ref. mm)	2.0	2.2	2.4	2.8	3.3	3.8	4.3	4.8	5.7	6.7	7.6	9.7

3/8" Hand Sockets

3027.50	D (mm)	H (mm)	L (mm)	(g)	(pcs.)
M 5	18	23.5	50	38	10
M 6	18	23.5	50	38	10
M 7	18	23.5	50	38	10
M 8	18	23.5	50	39	10
M 9	20	23.5	50	40	10
M10	20	23.5	50	40	10
M12	20	23.5	50	41	10

3027.100	D (mm)	H (mm)	L (mm)	(g)	(pcs.)
M 5	18	73.5	100	40	10
M 6	18	73.5	100	42	10
M 8	18	73.5	100	45	10
M10	20	73.5	100	52	10
M12	20	73.5	100	73	10

3027-50 • -100 Bit Sockets for Ribe Screws Vasos con Punta Ribe

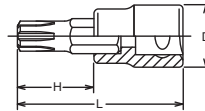
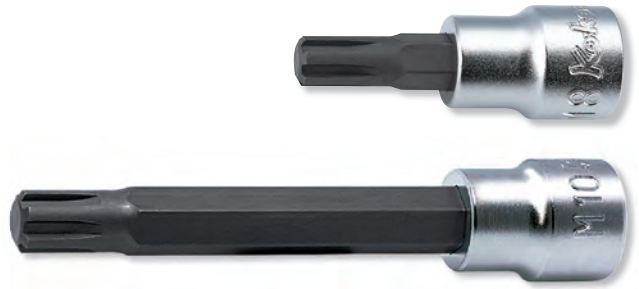

Ribe CV

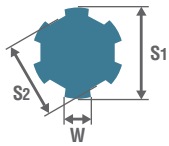

CV		M5	M6	M7	M8	M9	M10	M12	M13	M14	M16
W	(ref. mm)	1.2	1.3	1.4	1.8	2.0	2.3	2.6	3.1	3.2	3.6
S ₁	(ref. mm)	5.0	6.0	7.0	8.0	9.0	10.0	12.0	13.0	14.0	16.0
S ₂	(ref. mm)	3.8	4.5	5.0	6.0	7.1	7.4	9.0	11.0	10.4	11.9

RS3027/5-L50	5 Pieces Set/Rail 150mm	(g)
M5, M6, M8, M10, M12		240

RS3027/5-L50 Socket Set on Rail Juego de Vasos en Regleta



3001 (PH)	D (mm)	H (mm)	L (mm)	(g)	(pcs.)
2	18	42	60	38	10
3	18	42	60	38	10
4	18	42	60	38	10

3001 Phillips Bit Sockets Vasos con Punta Phillips

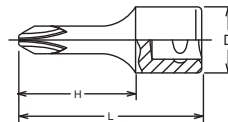

3006	TxW (mm)	D (mm)	H (mm)	L (mm)	(g)	(pcs.)
5	1.0x 5	18	42	60	35	10
8	1.2x 8	18	42	60	42	10
10	1.6x10	20	42	60	50	10

3006 Slotted Bit Sockets Vasos con Punta Recta para Cabeza Ranurada

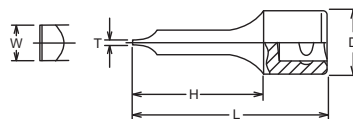

 3001, 3006 are for hand use only.
Do not use with a power or impact wrench.

Z-SERIES
HAND
MANUALES
TITANIUM
DE TITANIO
ACCESSORIES
ACCESORIOS
SCREWDRIVERS
DESTORNILLADORES
IMPACT
DE IMPACTO
SLEEVE-DRIVE
INDUSTRIAL
INDUSTRIALES
PROTECTOR
PROTECTORES
AUTOMOTIVE
CONSTRUCTION
CONSTRUCCION
RENEWAL KITS
JUEGOS DE PIEZAS/REUESTO

Hand Sockets **3/8"**

Z-SERIES
HAND
MANUALES

TITANIUM
DE TITANIO

ACCESSORIES
ACCESORIOS

SCREWDRIVERS
DESTORNILLADORES

IMPACT
DE IMPACTO

SLEEVE-DRIVE
INDUSTRIAL

INDUSTRIAL
INDUSTRIALES

PROTECTOR
PROTECTORES

AUTOMOTIVE

CONSTRUCTION
CONSTRUCCIÓN

RENEWAL KITS
JUEGOS DE PIEZAS REPUSTO

2749PS-3/8 Reversible Ratchet Short Llave de Carraca Reversible Corta

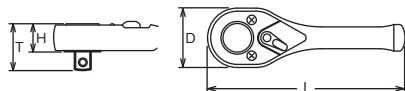

* Renewal Kits → 2749RK-3/8 → P304

	D (mm)	T (mm)	H (mm)	L (mm)	(g)	(pcs.)
2749PS-3/8	25	21.9	11.2	75	70	10

2749N-3/8 Reversible Ratchet Llave de Carraca Reversible



* Renewal Kits → 2749RK-3/8 → P304

2749P-3/8 Reversible Ratchet Llave de Carraca Reversible



* Renewal Kits → 2749RK-3/8 → P304

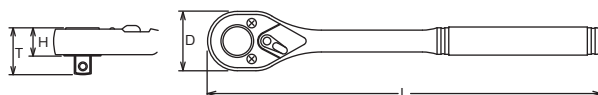

	D (mm)	T (mm)	H (mm)	L (mm)	(g)	(pcs.)
2749N-3/8	25	21.9	11.2	125	104	10
2749P-3/8	25	21.9	11.2	125	101	10

⚠ 2749-3/8 series have less strength compared with normal **38** ratchet due to the technical design. Make sure to use the ratchet correctly.

3749S Reversible Ratchet Short Llave de Carraca Reversible Corta



* Renewal Kits → 3749RK → P304

3749SB Reversible Ratchet with Quick Release Button Short Llave de Carraca Reversible con botón de extracción rápida Corta



* Renewal Kits → 3749BRK → P304

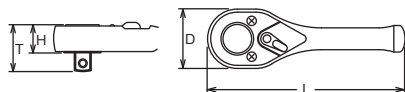

	D (mm)	T (mm)	H (mm)	L (mm)	(g)	(pcs.)
3749S	34	24.8	14.1	110	183	5
3749SB	34	24.8	14.1	110	183	5

⚠ Reversible Ratchet with quick release button has less strength compared with normal ratchet due to the technical design. Make sure to use the ratchet correctly.

3749N Reversible Ratchet Llave de Carraca Reversible



* Renewal Kits → 3749RK → P304

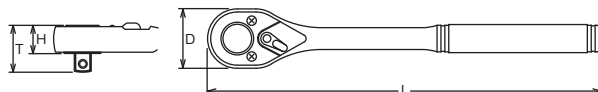

	D (mm)	T (mm)	H (mm)	L (mm)	(g)	(pcs.)
3749N	34	24.8	14.1	200	340	1

[L/R Marking]



A pointer and L/R markings on the ratchet head indicate the turning direction. The reduced diameter of the head allows easier access in tight spots.

Una flecha y unas marcas L/R en el cabezal de la llave (L = izquierda / R = Derecha) indican el sentido de giro. El diámetro reducido del cabezal permite un acceso más fácil en lugares estrechos.



* Renewal Kits → 3752RK → P305

3752N Reversible Ratchet Llave de Carraca Reversible



* Renewal Kits → 3752RK → P305

3752J Reversible Ratchet Llave de Carraca Reversible



	D (mm)	T (mm)	H (mm)	L (mm)	(g)	(pce.)
3752N	33	34.3	23.9	200	310	1
3752J	33	34.3	23.9	200	310	1

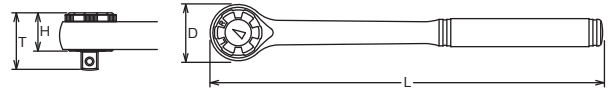

* Renewal Kits → 3752RK → P305

3776N Swivel Head Ratchet Llave de Carraca de Cabeza Giratoria



* Renewal Kits → 3752RK → P305

3776P Swivel Head Ratchet Llave de Carraca de Cabeza Giratoria



* Renewal Kits → 3752RK → P305

3776J Swivel Head Ratchet Llave de Carraca de Cabeza Giratoria



	D (mm)	T (mm)	H (mm)	L (mm)	(g)	(pce.)
3776N	44	34.3	23.9	280	565	1
3776P	44	34.3	23.9	280	560	1
3776J	44	34.3	23.9	280	510	1

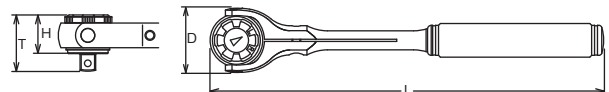

Z-SERIES
HAND
MANUALES
TITANIUM
DE TITANIO
ACCESSORIES
ACCESORIOS
SCREWDRIVERS
DESTORNILLADORES
IMPACT
DE IMPACTO
SLEEVE-DRIVE
INDUSTRIAL
INDUSTRIALES
PROTECTOR
PROTECTORES
AUTOMOTIVE
CONSTRUCTION
CONSTRUCCION
RENEWAL KITS
JUEGOS DE PIEZAS/REPUESTO

Hand Sockets **3/8"**

Z-SERIES

HAND
MANUALES

TITANIUM
DE TITANIO

ACCESSORIES
ACCESORIOS

SCREWDRIVERS
DESTORNILLADORES

IMPACT
DE IMPACTO

SLEEVE-DRIVE

INDUSTRIAL
INDUSTRIALES

PROTECTOR
PROTECTORES

AUTOMOTIVE

CONSTRUCTION
CONSTRUCCIÓN

RENEWAL KITS
JUEGOS DE PIEZAS REPUESTO

3753SM Multi Purpose Ratchet, Reversible Llave de Carraca de Aplicación General, Reversible

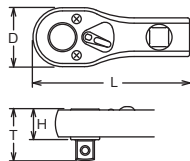

* Renewal Kits → 3753RK → P304

	D (mm)	T (mm)	H (mm)	L (mm)	(g)	(pcs.)
3753SM	30.5	26.4	15.7	81	175	5



3753N Reversible Ratchet Llave de Carraca Reversible



* Renewal Kits → 3753RK → P304

3753P Reversible Ratchet Llave de Carraca Reversible



* Renewal Kits → 3753RK → P304

3753J Reversible Ratchet Llave de Carraca Reversible



* Renewal Kits → 3753RK → P304

D3753J Reversible Ratchet Llave de Carraca Reversible



* Renewal Kits → 3753RK → P304

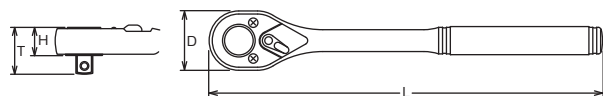

	D (mm)	T (mm)	H (mm)	L (mm)	(g)	(pce.)
3753N	30.5	26.4	15.7	200	320	1
3753P	30.5	26.4	15.7	200	286	1
3753J	30.5	26.4	15.7	200	260	1
D3753J	30.5	26.4	15.7	200	260	1

3753P-250 Reversible Ratchet Long Llave de Carraca Reversible Larga ⚠



* Renewal Kits → 3753RK → P304

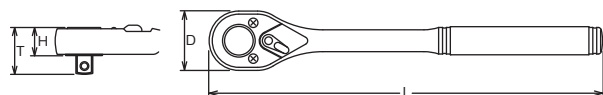

	D (mm)	T (mm)	H (mm)	L (mm)	(g)	(pce.)
3753P-250	30.5	26.4	15.7	250	335	1

⚠ 3753P-250 have longer handle than standard, and can be loaded to excessive torque value. In the interest of your own safety always apply load evenly and progressively to avoid breakage and possible injury.

3/8" Hand Sockets

Z-SERIES
HAND
MANUALES
TITANIUM
DE TITANIO
ACCESSORIES
ACCESORIOS
DESTORNILLADORES
DE IMPACTO
SLEEVE-DRIVE
INDUSTRIAL
INDUSTRIALES
PROTECTOR
PROTECTORES
AUTOMOTIVE
CONSTRUCTION
CONSTRUCCIÓN
RENEWAL KITS
JUEGOS DE PIEZAS/REPUESTO



* Renewal Kits → 3753BRK → P304

	D (mm)	T (mm)	H (mm)	L (mm)	(g)	(pcs.)
3753SMB	30.5	26.4	15.7	81	175	5

3753SMB Multi Purpose Ratchet with Quick Release Button

Llave de Carraca de Aplicación General, reversible ⚠

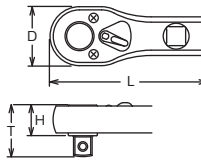

3753NB Reversible Ratchet with Quick Release Button

Llave de Carraca Reversible con botón de extracción rápida ⚠



* Renewal Kits → 3753BRK → P304



3753PB Reversible Ratchet with Quick Release Button

Llave de Carraca Reversible con botón de extracción rápida ⚠



* Renewal Kits → 3753BRK → P304



3753JB Reversible Ratchet with Quick Release Button

Llave de Carraca Reversible con botón de extracción rápida ⚠



* Renewal Kits → 3753BRK → P304



	D (mm)	T (mm)	H (mm)	L (mm)	(g)	(pce.)
3753NB	30.5	26.4	15.7	200	320	1
3753PB	30.5	26.4	15.7	200	286	1
3753JB	30.5	26.4	15.7	200	260	1

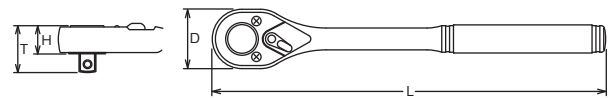

Reversible Ratchet with Quick Release Button :
Sockets and accessories are safely locked.
By pushing the button the sockets or extension bars are released from the ratchet.

Llave de Carraca Reversible con Botón de Extracción Rápida : Los vasos y accesorios se bloquean en posición. Los vasos o las alargaderas se extraen de la llave apretando el botón.

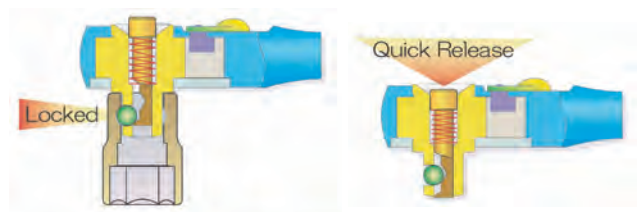

⚠ Reversible Ratchet with quick release button has less strength compared with normal ratchet due to the technical design. Make sure to use the ratchet correctly.

Hand Sockets **3/8"**

Z-SERIES
HAND
MANUALES

TITANIUM
DE TITANIO

ACCESSORIES
ACCESORIOS

SCREWDRIVERS
DESTORNILLADORES

IMPACT
DE IMPACTO

SLEEVE-DRIVE
MANGUITO

INDUSTRIAL
INDUSTRIALES

PROTECTOR
PROTECTORES

AUTOMOTIVE

CONSTRUCTION
CONSTRUCCIÓN

RENEWAL KITS
JUEGOS DE PIEZAS/REPUESTO

2774PS-3/8 Flexible Ratchet, Reversible
Llave de Carraca Flexible, Reversible 



* Renewal Kits → 2749RK-3/8 → P304



2774JS-3/8 Flexible Ratchet, Reversible
Llave de Carraca Flexible, Reversible 

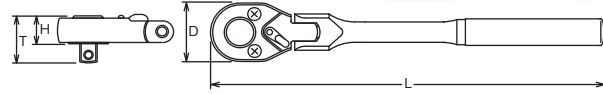

* Renewal Kits → 2749RK-3/8 → P304



	D (mm)	T (mm)	H (mm)	L (mm)	(g)	(pcs.)
2774PS-3/8	25	21.9	11.2	120	133	5
2774JS-3/8	25	21.9	11.2	120	113	5

 2774-3/8 series have less strength compared with normal  ratchet due to the technical design. Make sure to use the ratchet correctly.

3774PS Flexible Ratchet, Reversible
Llave de Carraca Flexible, Reversible



* Renewal Kits → 3753RK → P304

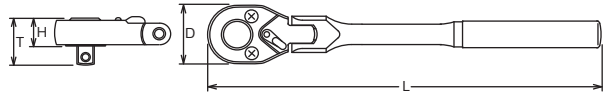

	D (mm)	T (mm)	H (mm)	L (mm)	(g)	(pcs.)
3774PS	30.5	26.4	15.7	175	250	2

3774N Flexible Ratchet, Reversible
Llave de Carraca Flexible, Reversible



* Renewal Kits → 3753RK → P304

3774P Flexible Ratchet, Reversible
Llave de Carraca Flexible, Reversible



* Renewal Kits → 3753RK → P304

3774J Flexible Ratchet, Reversible
Llave de Carraca Flexible, Reversible



* Renewal Kits → 3753RK → P304

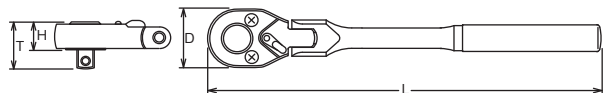

	D (mm)	T (mm)	H (mm)	L (mm)	(g)	(pcs.)
3774N	30.5	26.4	15.7	265	378	2
3774P	30.5	26.4	15.7	265	378	2
3774J	30.5	26.4	15.7	285	367	1



* Renewal Kits → 3753BRK → P304

3774P-SR Speeder Ratchet



	D (mm)	T (mm)	H (mm)	A (mm)	L (mm)	(g)	(pcs.)
3774P-SR	30.5	26.4	15.7	34	310	435	1

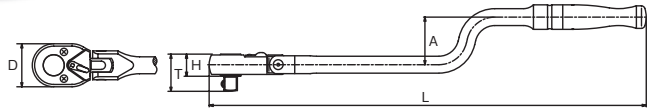

* Renewal Kits → 3753BRK → P304



3774NB

Flexible Ratchet, Reversible with Quick Release Button
Llave de Carraca Flexible, reversible con botón de extracción rápida ⚠



* Renewal Kits → 3753BRK → P304

3774PB

Flexible Ratchet, Reversible with Quick Release Button
Llave de Carraca Flexible, reversible con botón de extracción rápida ⚠

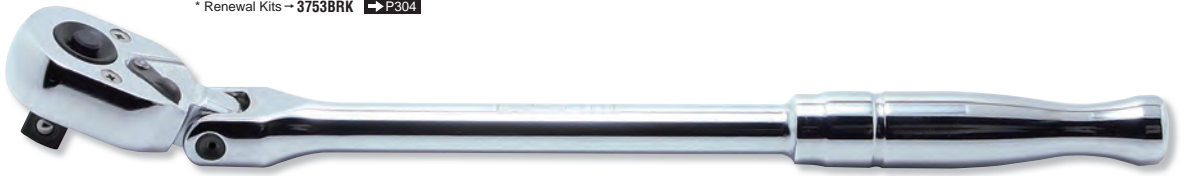

* Renewal Kits → 3753BRK → P304

3774JB

Flexible Ratchet, Reversible with Quick Release Button
Llave de Carraca Flexible, reversible con botón de extracción rápida ⚠



	D (mm)	T (mm)	H (mm)	L (mm)	(g)	(pcs.)
3774NB	30.5	26.4	15.7	265	378	2
3774PB	30.5	26.4	15.7	265	373	2
3774JB	30.5	26.4	15.7	285	367	1

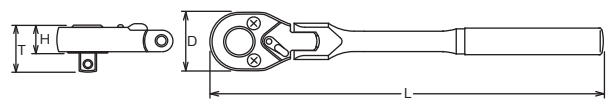

Reversible Ratchet with Quick Release Button :
Sockets and accessories are safely locked.
By pushing the button the sockets or extension bars are released from the ratchet.

Llave de Carraca Reversible con Botón de Extracción Rápida : Los vasos y accesorios se bloquean en posición. Los vasos o las alargaderas se extraen de la llave apretando el botón.

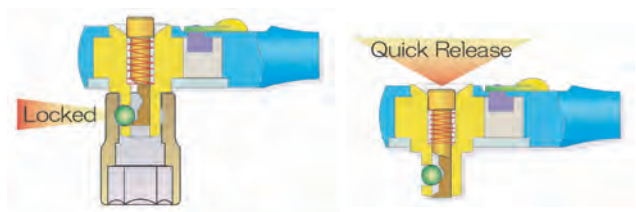

⚠ Reversible Ratchet with quick release button has less strength compared with normal ratchet due to the technical design. Make sure to use the ratchet correctly.

Hand Sockets **3/8"**

Z-SERIES
HAND
MANUALES

TITANIUM
DE TITANIO

ACCESSORIES
ACCESORIOS

SCREWDRIVERS
DESTORNILLADORES

IMPACT
DE IMPACTO

SLEEVE-DRIVE
INDUSTRIAL

INDUSTRIAL
INDUSTRIALES

PROTECTOR
PROTECTORES

AUTOMOTIVE

CONSTRUCTION
CONSTRUCCIÓN

RENEWAL KITS
JUEGOS DE PIEZAS REPUESTO

3774NL Flex-Head Ratchet with Head Lock Button Llave de Carraca Flexible con Botón de Bloqueo de la Cabeza



* Renewal Kits → 3753RK → P304



3774PL Flex-Head Ratchet with Head Lock Button Llave de Carraca Flexible con Botón de Bloqueo de la Cabeza



* Renewal Kits → 3753RK → P304



3774JL Flex-Head Ratchet with Head Lock Button Llave de Carraca Flexible con Botón de Bloqueo de la Cabeza



* Renewal Kits → 3753RK → P304



3774JBL ⚠️ Flex-Head Ratchet with Head Lock Button and Quick Release Button Llave de Carraca Flexible con Botón de Bloqueo de la Cabeza y Botón de Extracción Rápida



* Renewal Kits → 3753BRK → P304

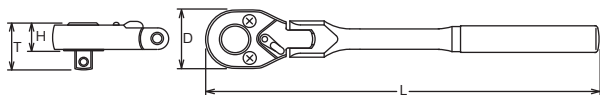

	D (mm)	T (mm)	H (mm)	L (mm)	(g)	(pcs.)
3774NL	30.5	26.4	15.7	265	378	2
3774PL	30.5	26.4	15.7	265	378	2
3774JL	30.5	26.4	15.7	285	367	1
3774JBL	30.5	26.4	15.7	285	367	1

⚠️ Reversible Ratchet with quick release button has less strength compared with normal ratchet due to the technical design. Make sure to use the ratchet correctly.

45

* Renewal Kits → 3755RK → P306

	D (mm)	L (mm)	(g)	(pcs.)
3755	30.5	55	146	5

3755 Ratchet Adaptor
Adaptador de carraca

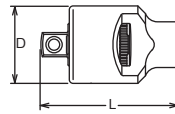

	D (mm)	L (mm)	(g)	(pcs.)
3756	30.5	25.5	47	10

3756 Quick Spinner
Disco de Giro Rápido

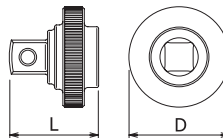

L/R Marking 45

* Renewal Kits → 3752RK → P305

	D (mm)	L (mm)	(g)	(pcs.)
3757	50	35	155	5

3757 Ratchet Wheel
Rueda de carraca

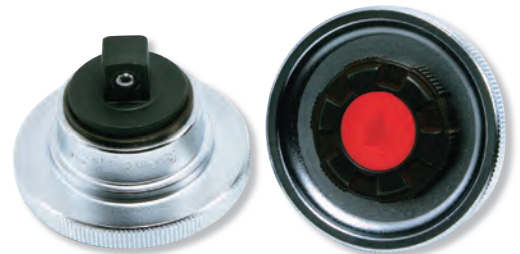
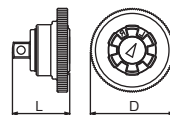

3762 Flexible Extension Bar
Alargadera Flexible



	D (mm)	L (mm)	(g)	(pcs.)
3762	19.3	300	178	2

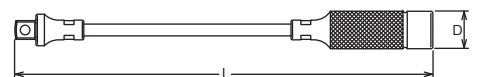

Z-SERIES
HAND
MANUALES
TITANIUM
DE TITANIO
ACCESSORIES
ACCESORIOS
SCREWDRIVERS
DESTORNILLADORES
IMPACT
DE IMPACTO
SLEEVE-DRIVE
INDUSTRIAL
INDUSTRIALES
PROTECTOR
PROTECTORES
AUTOMOTIVE
CONSTRUCTION
CONSTRUCCION
RENEWAL KITS
JUEGOS DE PIEZAS/REPOSTO

Hand Sockets **3/8"**

Z-SERIES

HAND
MANUALES

TITANIUM
DE TITANIO

ACCESSORIES
ACCESORIOS

SCREWDRIERS
DESTORNILLADORES

IMPACT
DE IMPACTO

SLEEVE-DRIVE
INDUSTRIAL

INDUSTRIAL
INDUSTRIALES

PROTECTOR
PROTECTORES

AUTOMOTIVE

CONSTRUCTION
CONSTRUCCIÓN

RENEWAL KITS
JUEGOS DE PIEZAS REPUESTO

3760 Extension Bars Alargaderas

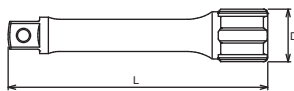

3760	D (mm)	L (mm)	(g)	(pcs.)
32	18	32	27	10
50	18	50	47	10
75	18	75	68	10
125	18	125	106	10
150	18	150	125	10
250	18	250	196	5
300	18	300	291	2
400	18	400	365	1
500	18	500	490	1
600	18	600	538	1
900	18	900	805	1
1000	18	1000	968	1

PK3760/6 Set Juego



PK3760/6	6 Pieces Set/Δ=670g
PLASTIC TRAY	
Extension Bars	
3760 Extension Bars 32, 50, 75, 125, 150, 250	

3763 Wobble-Fix Extension Bars Alargaderas Articuladas-Fijas



3763	D (mm)	L (mm)	(g)	(pcs.)
32	18	32	26	10
50	18	50	42	10
75	18	75	57	10
125	18	125	80	10
150	18	150	98	10
250	18	250	144	5
300	18	300	170	2

PK3763/6 Set Juego



PK3763/6	6 Pieces Set/Δ=560g
PLASTIC TRAY	
Extension Bars	
3763 Wobble-Fix Extension Bars 32, 50, 75, 125, 150, 250	

Wobble-Fix Extension Bar

Two way usage : one for as a flexible extension bar to provide at 15° angle operation, the other for use as a normal extension bar. This usage is Patent.

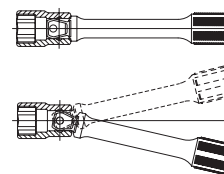

Alargadera Articulada-Fija

Dos formas de utilización : Una como alargadera flexible para poder trabajar con un ángulo de 15° y otra para utilizarse como alargadera normal. Esta aplicación está patentada.

! The Wobble-Fix Extension Bar has less strength than normal extension bar due to it's specific design with a reduced square drive. Make sure to use it correctly.

3/8" Hand Sockets



RENEWAL KIT FOR HINGE HANDLE



OVAL SHAPE SHANK



OVAL Shank

* Renewal Kits → 3768RK → P306

3768N-175 Hinge Handle
Mango Articulado



OVAL Shank

* Renewal Kits → 3768RK → P306

3768N-250 Hinge Handle
Mango Articulado



OVAL Shank

* Renewal Kits → 3768RK → P306

3768P-250 Hinge Handle
Mango Articulado



OVAL Shank

* Renewal Kits → 3768RK → P306

3768J-250 Hinge Handle
Mango Articulado



	D (mm)	L (mm)	⚖️ (g)	📦 (pcs.)
3768N-175	20.5	175	255	5
3768N-250	20.5	250	290	5
3768P-250	20.5	250	275	5
3768J-250	20.5	250	248	2

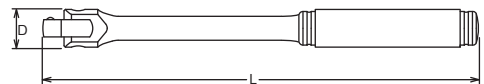

OVAL Shank

* Renewal Kits → 3768RK → P306

3768N-300 Hinge Handle
Mango Articulado ⚠️



* Renewal Kits → 3768RK → P306

3768P-380 Hinge Handle
Mango Articulado ⚠️



	D (mm)	L (mm)	⚖️ (g)	📦 (pcs.)
3768N-300	20.5	300	320	2
3768P-380	20.5	380	435	2

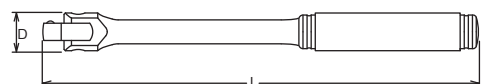

⚠️ 3768-300, -380 have longer handle than standard, and can be loaded to excessive torque value. In the interest of your own safety always apply load evenly and progressively to avoid breakage and possible injury.

Z-SERIES
HAND
MANUALES
TITANIUM
DE TITANIO
ACCESSORIES
ACCESORIOS
SCREWDRIVERS
DESTORNILLADORES
IMPACT
DE IMPACTO
SLEEVE-DRIVE
INDUSTRIAL
INDUSTRIALES
PROTECTOR
PROTECTORES
AUTOMOTIVE
CONSTRUCTION
CONSTRUCCION
RENEWAL KITS
JUEGOS DE PIEZAS/REPUESTO

Hand Sockets **3/8"**

Z-SERIES
HAND
MANUALES

TITANIUM
DE TITANIO

ACCESSORIES
ACCESORIOS

SCREWDRIVERS
DESTORNILLADORES

IMPACT
DE IMPACTO

SLEEVE-DRIVE
MANGUERA

INDUSTRIAL
INDUSTRIALES

PROTECTOR
PROTECTORES

AUTOMOTIVE
AUTOMOTIV

CONSTRUCTION
CONSTRUCCIÓN

RENEWAL KITS
JUEGOS DE PIEZAS/REPUES

3769N-160 • -230 Spin Type Handle Mango Tipo Destornillador



3769N	H (mm)	L (mm)	(g)	(pcs.)
160	50	160	96	2
230	120	230	126	2

 Plastic or rubber handles are not intended to act as insulation.
Los mangos de plástico o de goma no están previstos para aislamiento.

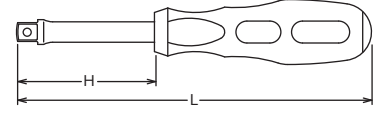

3769NWF-160 • -230 Spin Type Handle Wobble-Fix Mango Tipo Destornillador Articulados-Fijos

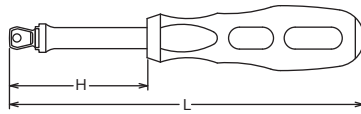
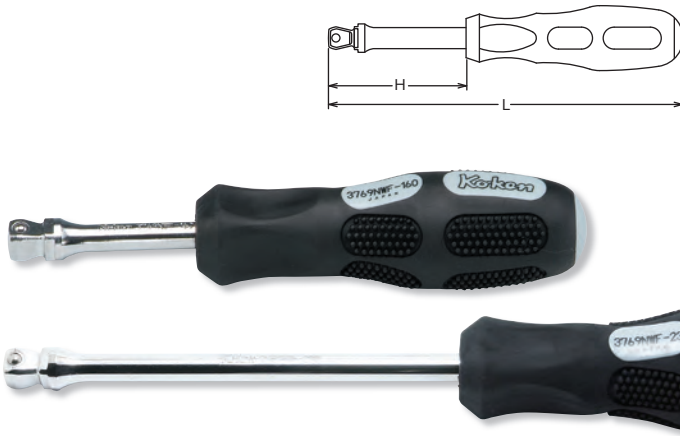

3769NWF	H (mm)	L (mm)	(g)	(pcs.)
160	50	160	96	2
230	120	230	126	2

 Plastic or rubber handles are not intended to act as insulation.
Los mangos de plástico o de goma no están previstos para aislamiento.

Wobble-Fix Extension Bar

Two way usage : one for as a flexible extension bar to provide at 15° angle operation, the other for use as a normal extension bar. This usage is Patent.

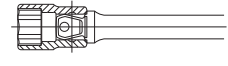

Alargadera Articulada-Fija

Dos formas de utilización : Una como alargadera flexible para poder trabajar con un ángulo de 15° y otra para utilizarse como alargadera normal. Esta aplicación está patentada.

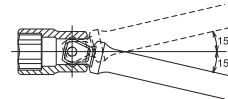

3769H Folding Socket Driver Llave de Vaso Plegable

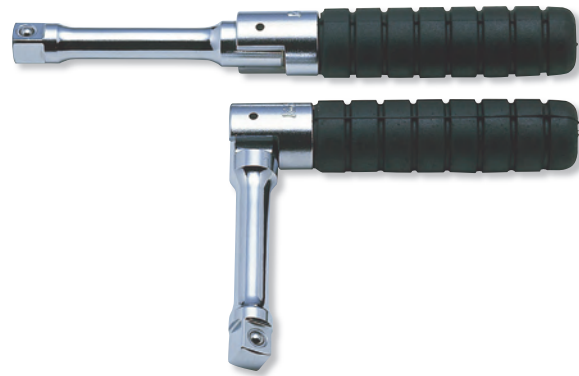

3769H	L (mm)	(g)	(pcs.)
3769H	170	210	2

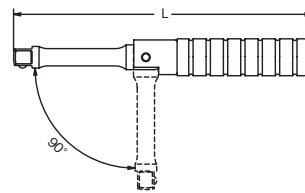

3770 Universal Joint Articulación Universal

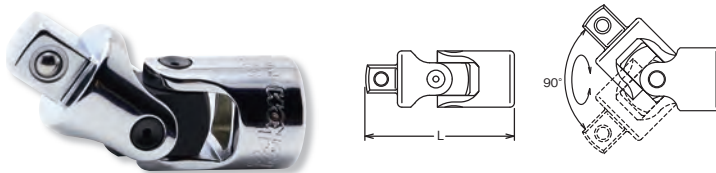

3770	L (mm)	(g)	(pcs.)
3770	50	66	10

3771 Universal Joint Articulación Universal

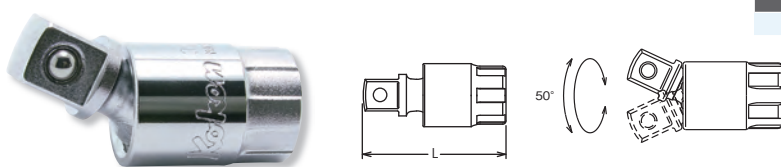

3771	L (mm)	(g)	(pcs.)
3771	43	46	10



3/8" Hand Sockets

	L (mm)	(g)	(pcs.)
3780	400	432	1

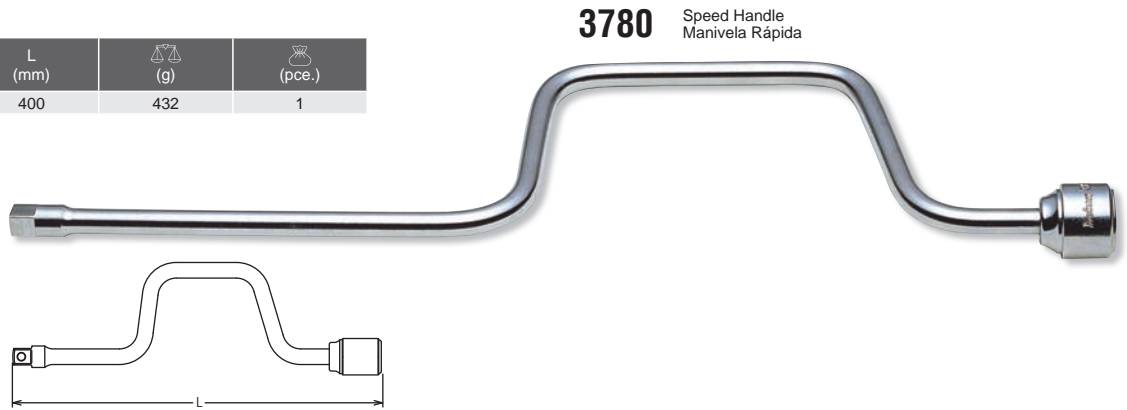

3780 Speed Handle
Manivela Rápida



3785 T-Handle
Mango Corredizo

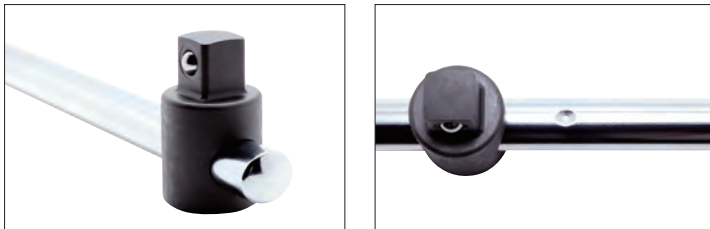

Innovative Oval shaped bar provides higher durability and stops the sliding square part turning around the bar.

	L (mm)	(g)	(pcs.)
3785	200	157	5

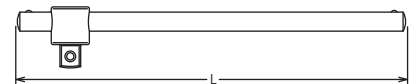

	(sq)	(sq)	L (mm)	(g)	(pcs.)
3322A	3/8"	1/4"	24	18	10
3344A	3/8"	1/2"	30	35	10

⚠ Adapting down from bigger square drive to smaller square drive may lead to excessive torque and possibly cause breakage.

La adaptación de mayor a menor de un cuadrado conductor puede conducir a un par excesivo que puede causar roturas.

3322A Adaptor
Adaptador Warranty 86Nm
Garantía 86Nm **⚠**

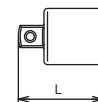

3344A Adaptor
Adaptador

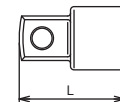

PK2346/6	6 Pieces Set/6 Pzas=460g	
PLASTIC TRAY		

Adaptors

1/4" □ → 3/8" □	2233A	3/8" □ → 1/4" □	3322A
3/8" □ → 1/2" □	3344A	1/2" □ → 3/8" □	4433A-35
1/2" □ → 3/4" □	4466A	3/4" □ → 1/2" □	6644A

PK2346/6 Set
Juego

- 2233A (1/4" X 3/8")
- 3322A (3/8" X 1/4") Warranty/Garantía 86Nm
- 3344A (3/8" X 1/2")
- 4433A (1/2" X 3/8") Warranty/Garantía 290Nm
- 4466A (1/2" X 3/4")
- 6644A (3/4" X 1/2") Warranty/Garantía 668Nm



Z-SERIES
HAND
MANUALES
TITANIUM
DE TITANIO
ACCESSORIES
ACCESORIOS
SCREWDRIVERS
DESTORNILLADORES
IMPACT
DE IMPACTO
SLEEVE-DRIVE
INDUSTRIAL
INDUSTRIALES
PROTECTOR
PROTECTORES
AUTOMOTIVE
CONSTRUCTION
CONSTRUCCION
RENEWAL KITS
JUEGOS DE PIEZAS/REPLUESTO

Hand Sockets **3/8"**

Z-SERIES
HAND
MANUALES

TITANIUM
DE TITANIO

ACCESSORIES
ACCESORIOS

SCREWDRIVERS
DESTORNILLADORES

IMPACT
DE IMPACTO

SLEEVE-DRIVE
SLEEVES

INDUSTRIAL
INDUSTRIALES

PROTECTOR
PROTECTORES

AUTOMOTIVE

RENEWAL KITS
JUEGOS DE PIEZAS REPUESTO
CONSTRUCCION
CONSTRUCCION

3200M • 3200A

Socket Sets
Juegos de Vasos



3201AMW

Socket Set
Juego de Vasos



3206M

Socket Set
Juego de Vasos



3206A

Socket Set
Juego de Vasos



3206AM

Socket Set
Juego de Vasos



3200M 18 Pieces Set/△=2,250g

METAL CASE:W415xH120xT50mm

Sockets	Accessories
<ul style="list-style-type: none"> 3400M 6-pt. Sockets 6, 8, 9, 10, 11, 12 3405M 12-pt. Sockets 13, 14, 17, 18, 19, 21 	<ul style="list-style-type: none"> 3753N 3760-125 3760-250 3768N-250 3769N-160 3785

3200A 18 Pieces Set/△=2,250g

METAL CASE:W415xH120xT50mm

Sockets	Accessories
<ul style="list-style-type: none"> 3400A 6-pt. Sockets 1/4, 5/16, 3/8, 7/16 3405A 12-pt. Sockets 1/2, 9/16, 19/32, 5/8, 11/16, 3/4, 13/16, 7/8 	<ul style="list-style-type: none"> 3753N 3760-125 3760-250 3768N-250 3769N-160 3785

3201AMW 42 Pieces Set/△=4,700g

METAL CASE:W445xH190xT50mm

Sockets	Accessories
<ul style="list-style-type: none"> 3405M 12-pt. Sockets 9, 10, 11, 12, 13, 14, 15, 16, 17, 18, 19, 20, 21, 22 3405A 12-pt. Sockets 5/16, 3/8, 7/16, 1/2, 9/16, 5/8, 11/16, 3/4, 25/32, 13/16, 7/8 3405W 12-pt. Sockets 1/8, 3/16, 1/4, 5/16, 3/8, 7/16, 1/2 	<ul style="list-style-type: none"> 3753N 3760-75 3760-125 3760-250 3768N-250 3769N-160 3770 3780 3785 3344A

3206M 21 Pieces Set/△=2,100g

METAL CASE:W395xH90xT50mm

Sockets	Accessories
<ul style="list-style-type: none"> 3400M 6-pt. Sockets 6, 7, 8, 9, 10, 11, 12 3405M 12-pt. Sockets 13, 14, 15, 16, 17, 18, 19, 21, 22 	<ul style="list-style-type: none"> 3753N 3760-125 3760-250 3768N-250 3785

3206A 17 Pieces Set/△=2,000g

METAL CASE:W395xH90xT50mm

Sockets	Accessories
<ul style="list-style-type: none"> 3400A 6-pt. Sockets 1/4, 5/16, 11/32, 3/8, 7/16 3405A 12-pt. Sockets 1/2, 9/16, 5/8, 11/16, 3/4, 13/16, 7/8 	<ul style="list-style-type: none"> 3753N 3760-125 3760-250 3768N-250 3785

3206AM 27 Pieces Set/△=3,500g

METAL CASE:W445xH190xT50mm

Sockets	Accessories
<ul style="list-style-type: none"> 3405M 12-pt. Sockets 7, 8, 10, 11, 12, 13, 14, 15, 16, 17, 19, 22 3405A 12-pt. Sockets 3/8, 7/16, 1/2, 9/16, 5/8, 11/16, 3/4, 13/16, 7/8 3300C Spark Plug Socket 20.8 	<ul style="list-style-type: none"> 3753N 3760-125 3760-250 3768N-250 3770

3210M 22 Pieces Set/△=2,900g

METAL CASE:W360xH145xT50mm

Sockets	Accessories
3400M 6-pt. Sockets 6, 7, 8, 9, 10, 11, 12	3753N
3405M 12-pt. Sockets 13, 14, 15, 16, 17, 18, 19, 21, 22	3760-125
	3760-250
	3768N-250
	3770
	3785

3215M 7 Pieces Set/△=430g

PLASTIC BAG

Sockets
3305M 12-pt. Deep Sockets 8, 10, 11, 12, 13, 14, 17

3215A 7 Pieces Set/△=430g

PLASTIC BAG

Sockets
3305A 12-pt. Deep Sockets 5/16, 3/8, 7/16, 1/2, 9/16, 5/8, 11/16

3217M 14 Pieces Set/△=850g

METAL CASE:W163xH52xT33mm

Sockets
3405M 12-pt. Sockets 9, 10, 11, 12, 13, 14, 15, 16, 17, 18, 19, 20, 21, 22

3220M 14 Pieces Set/△=2,270g

METAL CASE:W415xH120xT50mm

Sockets	Accessories
3405M 12-pt. Sockets 8, 9, 10, 11, 12, 13, 14, 17, 19, 21, 22	3753N
	3760-125
	3760-250
	3768N-250

3221M 18 Pieces Set/△=2,300g

METAL CASE:W415xH120xT50mm

Sockets	Accessories
3405M 12-pt. Sockets 6, 8, 9, 10, 11, 12, 13, 14, 17, 19, 21, 22	3753N
	3760-125
	3760-250
	3768N-250
	3769N-160
	3785

3244 12 Pieces Set/△=1,110g

METAL CASE:W240xH100xT32mm

Sockets	Accessories
3025.50 TORX® Bit Sockets T20, T25, T27, T30, T40, T45, T50	3753N
3425 TORX® Sockets E8, E10, E12	3760-75

3210M Socket Set
Juego de Vasos



3215M · 3215A Socket Sets
Juegos de Vasos



3217M Socket Set
Juego de Vasos



3220M Socket Set
Juego de Vasos



3221M Socket Set
Juego de Vasos



3244 Socket Set
Juego de Vasos



Z-SERIES
HAND
MANUALES
TITANIUM
DE TITANIO
ACCESSORIES
ACCESORIOS
SCREWDRIVERS
DESTORNILLADORES
IMPACT
DE IMPACTO
SLEEVE-DRIVE
INDUSTRIAL
INDUSTRIALES
PROTECTOR
PROTECTORES
AUTOMOTIVE
CONSTRUCTION
CONSTRUCCION
RENEWAL KITS
JUEGOS DE HERRAMIENTAS

Hand Sockets 3/8"

Z-SERIES
HAND MANUALES
TITANIUM DE TITANIO
ACCESSORIES ACCESORIOS
SCREWDRIVERS DESTORNILLADORES
IMPACT DE IMPACTO
SLEEVE-DRIVE
INDUSTRIAL INDUSTRIALES
PROTECTOR PROTECTORES
AUTOMOTIVE
CONSTRUCTION CONSTRUCCIÓN
RENEWAL KITS JUEGOS DE PIEZAS/REPUÉS

3240M-00 ○ Display Stands Expositores
3240M-05 ○



S3240M-00 · S3240A-00 ○ Display Stands Expositores
S3240M-05 · S3240A-05 ○



3250M Socket Set Juego de Vasos



3252M Socket Set Juego de Vasos



P3262M-6P Socket Set Juego de Vasos



3240M-00 3400M 67 Pieces Set/△=2,800g
3240M-05 3405M 67 Pieces Set/△=2,800g

DISPLAY STAND:W410xH160xT500mm

Sockets		
6mm:4pcs	12mm:4pcs	18mm:4pcs
7mm:4pcs	13mm:4pcs	19mm:3pcs
8mm:4pcs	14mm:4pcs	20mm:3pcs
9mm:4pcs	15mm:4pcs	21mm:3pcs
10mm:4pcs	16mm:4pcs	22mm:3pcs
11mm:4pcs	17mm:4pcs	23mm:3pcs

S3240M-00 3400M 177 Pieces Set/△=10,300g
S3240M-05 3405M 177 Pieces Set/△=10,300g

DISPLAY STAND:W510xH150xT230mm

Sockets		
6mm:12pcs	12mm:12pcs	18mm:8pcs
7mm:12pcs	13mm:11pcs	19mm:8pcs
8mm:12pcs	14mm:11pcs	20mm:7pcs
9mm:12pcs	15mm:10pcs	21mm:7pcs
10mm:12pcs	16mm: 9pcs	22mm:7pcs
11mm:12pcs	17mm: 9pcs	23mm:6pcs

S3240A-00 3400A 126 Pieces Set/△=8,500g
S3240A-05 3405A 126 Pieces Set/△=8,500g

DISPLAY STAND:W510xH150xT230mm

Sockets		
1/4" :12pcs	9/16":10pcs	25/32":7pcs
5/16":12pcs	19/32":10pcs	13/16":7pcs
3/8" :12pcs	5/8" : 9pcs	7/8" :7pcs
7/16":12pcs	11/16": 9pcs	
1/2" :11pcs	3/4" : 8pcs	

3250M 17 Pieces Set/△=2,200g

METAL CASE:W415xH120xT50mm

Sockets	Accessories
○ 3400M 6-pt. Sockets 7, 8, 10, 11, 12, 13, 14, 15, 16, 17, 18, 19	3753N
	3760-125
	3760-250
	3770
	3785

3252M 15 Pieces Set/△=1,530g

METAL CASE:W310xH90xT48mm

Sockets	Accessories
○ 3400M 6-pt. Sockets 5.5, 7, 8, 10, 11, 12	3753P
○ 3405M 12-pt. Sockets 13, 14, 17, 19, 22	3760-75
	3760-125
	3770

P3262M-6P 11 Pieces Set/△=1,140g

PLASTIC CASE:W245xH120xT45mm

Sockets	Accessories
○ 3400M 6-pt. Sockets 8, 10, 12, 13, 14, 17, 19	3753N
	3760-75
	3760-125
	3770

3275 24 Pieces Set/△=3,150g
METAL CASE:W400xH147xT50mm

Sockets	Accessories
3400M 6-pt. Sockets 6, 7, 8, 9, 10, 11, 12	3753N
3405M 12-pt. Sockets 13, 14, 15, 16, 17, 18, 19, 21, 22	3760-125
3300C Spark Plug Sockets 16, 20.8	3760-250
	3768N-250
	3770
	3756

3276 20 Pieces Set/△=3,370g
METAL CASE:W310xH150xT50mm

Sockets	Accessories
3000 Bit Sockets 2, 3	3753N
3005 Bit Sockets 5, 8	3763-125
3010M.62 Hex Bit Sockets 5, 6, 7, 8, 10	
3025.50 TORX®Bit Sockets T10, T15, T20, T25, T27, T30, T40, T45, T50	

3277 29 Pieces Set/△=3,240g
METAL CASE:W370xH150xT50mm

Sockets	Accessories
3400M 6-pt. Sockets 8, 9, 10, 11, 12	3753N
3405M 12-pt. Sockets 13, 14, 15, 16, 17, 18, 19, 21	3760-125
3300M 6-pt. Deep Sockets 8, 9, 10, 11, 12	3768N-250
3305M 12-pt. Deep Sockets 13, 14, 15, 16, 17, 18, 19, 21	

3279AM 35 Pieces Set/△=4,200g
METAL CASE:W445xH190xT50mm

Sockets	Accessories
3405M 12-pt. Sockets 9, 10, 11, 12, 13, 14, 15, 16, 17, 18, 19, 20, 21, 22	3753N
3405A 12-pt. Sockets 5/16, 3/8, 7/16, 1/2, 9/16, 5/8, 11/16, 3/4, 25/32, 13/16, 7/8	3760-75
3300S Spark Plug Sockets 16, 20.8	3760-125
	3760-250
	3768N-250
	3769N-160
	3770
	3785

3275 Socket Set
Juego de Vasos



3276 Bit Socket Set
Juego de Vasos con Punta



3277 Socket Set
Juego de Vasos



3279AM Socket Set
Juego de Vasos



Z-SERIES
HAND
MANUALES
TITANIUM
DE TITANIO
ACCESSORIES
ACCESORIOS
SCREWDRIVERS
DESTORNILLADORES
IMPACT
DE IMPACTO
SLEEVE-DRIVE
INDUSTRIAL
INDUSTRIALES
PROTECTOR
PROTECTORES
AUTOMOTIVE
CONSTRUCTION
CONSTRUCCION
RENEWAL KITS
JUEGOS DE PIEZAS/REPLUESTO

Hand Sockets 1/2"

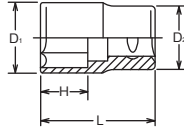

Z-SERIES
HAND MANUALES
TITANIUM DE TITANIO
ACCESSORIES ACCESORIOS
SCREWDRIVERS DESTORNILLADORES
IMPACT DE IMPACTO
SLEEVE-DRIVE
INDUSTRIAL INDUSTRIALES
PROTECTOR PROTECTORES
AUTOMOTIVE
CONSTRUCTION CONSTRUCCIÓN
RENEWAL KITS JUEGOS DE PIEZAS/REPUSTO

4400M 6-point Sockets Vasos Hexagonales

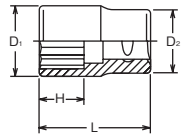

4405M 12-point Sockets Vasos Bihexagonales





4400M 4405M (mm)	D ₁ (mm)	D ₂ (mm)	H (mm)	L (mm)	 (g)	 (pcs.)
6	10.3	21	6	36	42	10
7	11.5	21	7	36	43	10
8	13.2	21	8	36	44	10
9	13.8	21	8.5	37	44	10
10	15.3	21	9	37	45	10
11	16.5	21	9.5	37	46	10
12	17.8	21	10	37	47	10
13	19	22	10.5	37	53	10
14	20.3	22	11	37	56	10
15	21.5	22	11.5	37	57	10
16	22.8	22	12	37	62	10
17	24	23	12.5	37	69	10
18	25	24	13	37	74	10
19	26.5	25	14	38	89	10
20	27.8	26	15	38	92	10
21	29	27	15.5	38	102	10
22	30	28	16	40	113	10
23	31.5	29	16.5	40	128	10
24	32.8	30	17	42	140	5
25	34	31	18	42	164	5
26	35	32	19	42	165	5
27	36.5	33	19.5	43	182	5
28	37.8	34	20	43	198	5
29	39	35	20.5	43	205	5
30	40	36	22	46	222	5
31	41.5	37	22.5	46	246	5
32	42.8	38	23	46	261	5
33	44.2	39	24	47	275	5
34	45.2	40	24	47	315	5
35	46.2	40	24	47	317	5
36	47.2	41	24	47	336	5
37	48.3	42	24	47	360	5
38	49.2	43	24	47	380	5
41	53.1	45	29	57	471	5
46	59.1	48	32	60	567	2













RS4400M/10 Socket Set on Rail Juego de Vasos en Regleta

RS4405M/10



RS4400M/10	10 Pieces Set/Rail 300mm	 (g)
10, 11, 12, 13, 14, 15, 17, 19, 21, 22		717

RS4405M/10	10 Pieces Set/Rail 300mm	 (g)
10, 11, 12, 13, 14, 15, 17, 19, 21, 22		717

	 6-Point	 12-Point	 Surface Drive	 Nut Grip®	 TORX® (E)	 TORXPLUS® (EPL)	 Double Square	 LHSTIX® (LH-S)
	No. 2400M/A No. 2300M/A No. 2400W-BA No. 2300W-BA No. 2300X series	No. 2405M/A No. 2305M/A No. AS2405A No. AS2305A series	No. 2410M No. 2310M series	No. 2450MS No. 2350M series	No. 2425 No. 2325 series	—	No. 2415M/A series	—
	No. 3400M/A No. 3300M/A No. 3400W No. 3300W No. 3300X/XA series	No. 3405M/A No. 3305M/A No. 3405W No. 3305W No. 3305X/XA series	No. 3410M No. 3310M series	No. 3450M No. 3450MH No. 3350M series	No. 3425 No. 3325 series	—	No. 3415M/A series	No. 3400LH series
	No. 4400M/A No. 4300M/A No. 4400W series	No. 4405M/A No. 4305M/A No. 4405W series	No. 4410M No. 4310M series	No. 4450M series	No. 4425 No. 4325 series	No. 4425-EPL series	—	No. 4400LH series

1/2" Hand Sockets

4400A 4405A (inch)	D ₁ (mm)	D ₂ (mm)	H (mm)	L (mm)	(g)	(pcs.)
1/4	10.7	21	6	36	41	10
5/16	13.2	21	8	36	44	10
3/8	14.6	21	9	37	45	10
7/16	16.5	21	9.5	37	46	10
1/2	19	22	10.5	37	53	10
9/16	20.3	22	11	37	56	10
19/32	21.5	22	11.5	37	57	10
5/8	22.8	22	12	37	62	10
21/32	24	23	12.5	37	69	10
11/16	25	24	13	37	74	10
3/4	26.5	25	14	38	89	10
25/32	27.8	26	15	38	92	10
13/16	29	27	15.5	38	102	10
7/8	30	28	16	40	113	10
15/16	32.8	30	17	42	140	5
31/32	34	31	18	42	165	5
1	35	32	19	42	165	5
1. 1/16	36.5	33	19.5	43	180	5
1. 1/8	39	35	20.5	43	210	5
1. 3/16	40	36	22	46	222	5
1. 1/4	42.8	38	23	46	261	5
1. 5/16	44.2	39	24	47	275	5
1. 3/8	46.2	40	24	47	317	5
1. 7/16	47.2	41	24	47	336	5
1. 1/2	49.2	43	24	47	380	5

RS4400A/10	10 Pieces Set/Rail 300mm	(g)
3/8, 7/16, 1/2, 9/16, 5/8, 11/16, 3/4, 13/16, 7/8, 15/16		809

RS4405A/10	10 Pieces Set/Rail 300mm	(g)
3/8, 7/16, 1/2, 9/16, 5/8, 11/16, 3/4, 13/16, 7/8, 15/16		809

4400W 4405W (W)	D ₁ (mm)	D ₂ (mm)	H (mm)	L (mm)	(g)	(pcs.)
3/16	16.5	21	9.5	37	46	10
1/4	19	22	10.5	37	54	10
5/16	21.5	22	11.5	37	54	10
3/8	25	24	13	37	73	10
7/16	29	27	15.5	38	87	10
1/2	31.5	29	16.5	40	133	10
9/16	35	32	19	42	165	5
5/8	37.8	34	20	43	191	5
11/16	40	36	22	46	222	5
3/4	44.2	39	24	47	280	5

RS4400W/8	8 Pieces Set/Rail 250mm	(g)
3/16, 1/4, 5/16, 3/8, 7/16, 1/2, 9/16, 5/8		860

RS4405W/8	8 Pieces Set/Rail 250mm	(g)
3/16, 1/4, 5/16, 3/8, 7/16, 1/2, 9/16, 5/8		860

4400A 6-point Sockets Vasos Hexagonales

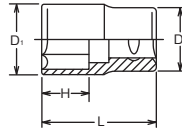

4405A 12-point Sockets Vasos Bihexagonales

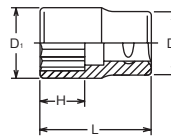

RS4400A/10 Socket Set on Rail Juego de Vasos en Regleta

RS4405A/10 Socket Set on Rail Juego de Vasos en Regleta



4400W 6-point Whitworth Sockets Vasos Whitworth Hexagonales

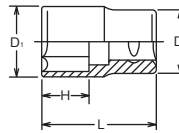

4405W 12-point Whitworth Sockets Vasos Whitworth Bihexagonales

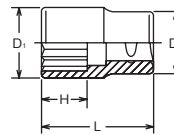

RS4400W/8 Socket Set on Rail Juego de Vasos en Regleta

RS4405W/8 Socket Set on Rail Juego de Vasos en Regleta



BS W



BS · W	BS	3/16BS	1/4BS	5/16BS	3/8BS	7/16BS	1/2BS	9/16BS	5/8BS	11/16BS	3/4BS	7/8BS
	W	1/8W	3/16W	1/4W	5/16W	3/8W	7/16W	1/2W	9/16W	5/8W	11/16W	3/4W
Across Flat	(ref. mm)	8.64	11.30	13.34	15.24	18.03	20.83	23.37	25.65	27.94	30.48	33.35

Z-SERIES
HAND
MANUALES
TITANIUM
DE TITANIO
ACCESSORIES
ACCESORIOS
SCREWDRIVERS
DESTORNILLADORES
IMPACT
DE IMPACTO
SLEEVE-DRIVE
INDUSTRIAL
INDUSTRIALES
PROTECTOR
PROTECTORES
AUTOMOTIVE
CONSTRUCTION
CONSTRUCCION
RENEWAL KITS
JUEGOS DE PIEZAS/REUESTO

Hand Sockets 1/2"

Z-SERIES
HAND
MANUALES

TITANIUM
DE TITANIO

ACCESSORIES
ACCESORIOS

IMPACT
DE IMPACTO

SLEEVE-DRIVE
DE MANGUITO

INDUSTRIAL
INDUSTRIALES

PROTECTOR
PROTECTORES

AUTOMOTIVE

CONSTRUCTION
CONSTRUCCIÓN

RENEWAL KITS
JUEGOS DE PIEZAS REPUESTO

4410M Surface Drive Sockets Vasos Surface Drive (de Contacto Curvo)

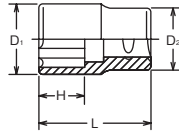

SURFACE DRIVE

4410M (mm)	D ₁ (mm)	D ₂ (mm)	H (mm)	L (mm)	(g)	(pcs.)
8	13.2	21	8	36	44	10
9	13.8	21	8.5	37	44	10
10	15.3	21	9	37	45	10
11	16.5	21	9.5	37	46	10
12	17.8	21	10	37	47	10
13	19	22	10.5	37	53	10
14	20.3	22	11	37	56	10
15	21.5	22	11.5	37	52	10
16	22.8	22	12	37	62	10
17	24	23	12.5	37	69	10
18	25	24	13	37	74	10
19	26.5	25	14	38	89	10
20	27.8	26	15	38	92	10
21	29	27	15.5	38	102	10
22	30	28	16	40	113	10
23	31.5	29	16.5	40	128	10
24	32.8	30	17	42	140	5
25	34	31	18	42	164	5
26	35	32	19	42	165	5
27	36.5	33	19.5	43	196	5
28	37.8	34	20	43	198	5
29	39	35	20.5	43	190	5
30	40	36	22	46	222	5
31	41.5	37	22.5	46	257	5
32	42.8	38	23	46	250	5
34	45.2	40	24	47	314	5

RS4410M/10 Socket Set on Rail Juego de Vasos en Regleta



RS4410M/10	10 Pieces Set/Rail 300mm	(g)
10, 11, 12, 13, 14, 15, 17, 19, 21, 22		717

4425 TORX® Sockets Vasos TORX®

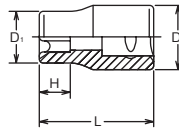

4425 (E)	D ₁ (mm)	D ₂ (mm)	H (mm)	L (mm)	(g)	(pcs.)
E 8	10.7	21	7	36	41	10
E10	13.2	21	8.2	36	44	10
E11	13.8	21	8.7	37	45	10
E12	14.6	21	9.3	37	47	10
E14	16.5	21	10.6	37	48	10
E16	19	22	11.8	37	57	10
E18	20.3	22	13	37	57	10
E20	22.8	22	14.4	37	63	10
E22	25	24	15.5	37	78	10
E24	26.5	25	17	40	95	5

RS4425/7 Socket Set on Rail Juego de Vasos en Regleta



RS4425/7	7 Pieces Set/Rail 200mm	(g)
E10, E12, E14, E16, E18, E20, E24		428

TORX® (E)

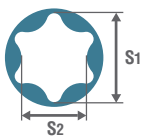

E	E4	E5	E6	E7	E8	E10	E11	E12	E14	E16	E18	E20	E22	E24	E26	E28	E30	E32
S ₁ (ref. mm)	3.7	4.6	5.6	6.1	7.4	9.3	9.9	11.0	12.8	14.6	16.5	18.3	20.1	22.0	23.7	25.5	27.3	29.0
S ₂ (ref. mm)	2.7	3.3	4.0	4.3	5.3	6.8	7.1	7.9	9.2	10.5	11.9	13.2	14.8	15.7	17.5	18.3	20.0	21.3

4425-N TORX® Sockets Vasos TORX®

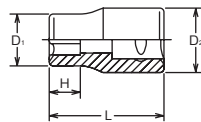

4425 (E)	D ₁ (mm)	D ₂ (mm)	H (mm)	L (mm)	(g)	(pcs.)
E10N	13.2	21	8.2	36	47	10
E12N	14.6	21	9.3	37	48	10
E14N	16.5	21	10.6	37	50	10
E16N	19	22	11.8	37	60	10
E18N	20.3	22	13	37	60	10
E20N	22.8	22	14.4	37	65	10

TORX Socket for Nut and low profile bolt
Shallow Chamfer on Socket Opening



A : Flywheel bolt MR20 NISSAN: 4425-E20N
B : Cam sprocket FA20 for TOYOTA/SUBARU: 4425-E16N
C : Connecting rod bolt FA20 for TOYOTA/SUBARU: 4425-E14N

RS4425/6-N Socket Set on Rail Juego de Vasos en Regleta



RS4425/6-N	6 Pieces Set/Rail 200mm	(g)
E10N, E12N, E14N, E16N, E18N, E20N		370

4425 (EPL)	D ₁ (mm)	D ₂ (mm)	H (mm)	L (mm)	(g)	(pcs.)
10EPL	13.2	21	6.2	36	45	10
12EPL	14.6	21	7.2	37	47	10
14EPL	16.5	21	8.1	37	49	10
16EPL	19	22	9.2	37	60	10
18EPL	20.3	22	10.2	37	60	10
20EPL	22.9	22	11.2	37	65	10

RS4425/6-EPL	6 Pieces Set/Rail 200mm	(g)
10EPL, 12EPL, 14EPL, 16EPL, 18EPL, 20EPL		390



TORX PLUS
EP/EPL-style



TORX
E-style



4450M (mm)	D ₁ (mm)	D ₂ (mm)	H (mm)	L (mm)	(g)	(pcs.)
10	15.3	21	6	36	44	10
11	16.5	21	6.5	36	46	10
12	17.8	21	7	36	46	10
13	19	22	8	36	57	10
14	20.3	22	8.5	36	54	10
15	21.5	22	9	36	52	10
16	22.8	22	9	36	60	10
17	24	23	9.5	36	68	10
18	25	24	10.5	36	77	10
19	26.5	25	11.5	36	85	10
21	29	27	12	37	110	10
22	30	28	12.5	37	105	10
24	32.8	30	14.5	39	130	5
27	36.5	33	16.5	40	139	5

RS4450M/10	10 Pieces Set/Rail 300mm	(g)
10, 11, 12, 13, 14, 15, 17, 19, 21, 22		717

4400LH (LH-S)	D ₁ (mm)	D ₂ (mm)	H (mm)	L (mm)	(g)	(pcs.)
6S	13.2	21	5.6	36	44	10
8S	16.5	21	6.8	37	46	10
10S	19	22	8	37	53	10
12S	22.8	22	9.2	37	62	10
14S	25	24	10.4	37	74	10
16S	29	27	11.6	38	102	10

RS4400LH/6	6 Pieces Set/Rail 200mm	(g)
6S, 8S, 10S, 12S, 14S, 16S		430

4425-EPL TORXPLUS® Sockets Vasos TORXPLUS®

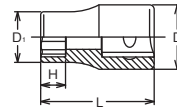

RS4425/6-EPL Socket Set on Rail Juego de Vasos en Regleta



Straight Sidewalls & Reduced Recess Fall Away

- Increase tool engagement
- Virtually eliminates camout
- Ensures proper torque transfer
- Greatly reduces end load requirements
- Can reduce worker fatigue and muscular stress during manual assembly

Elliptically-based Geometry and Lobe Engagement

- Broadens contact surface to maximize engagement of driver and recess
- Eliminates damaging point-to-point contact

0° Drive Angle

- Optimises torque transmission
- Virtually eliminates radial stresses to increase tool bit life
- Enables use of recesses with thinner walls

Six Lobes with Large Cross-Sectional Areas

- Enables faster tool engagement
- Maximizes torque transfer
- Increases torsional strength



4450M Nut Grip Sockets Nut Grip® Vasos Sujeta-Tuerca Nut Grip®

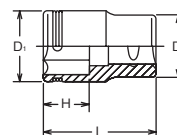

RS4450M/10 Socket Set on Rail Juego de Vasos en Regleta



4400LH LHS Sockets Vasos LHS

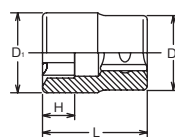

RS4400LH/6 Socket Set on Rail Juego de Vasos en Regleta



Z-SERIES
HAND
MANUALES
TITANIUM
DE TITANIO
ACCESSORIES
ACCESORIOS
SCREWDRIVERS
DESTORNILLADORES
IMPACT
DE IMPACTO
SLEEVE-DRIVE
INDUSTRIAL
INDUSTRIALES
PROTECTOR
PROTECTORES
AUTOMOTIVE
CONSTRUCTION
CONSTRUCCION
RENEWAL KITS
JUEGOS DE HEZAS/REPIESTO

Hand Sockets 1/2"

Z-SERIES
HAND MANUALES
TITANIUM DE TITANIO
ACCESSORIES ACCESORIOS
SCREWDRIVERS DESTORNILLADORES
IMPACT DE IMPACTO
SLEEVE-DRIVE
INDUSTRIAL INDUSTRIALES
PROTECTOR PROTECTORES
AUTOMOTIVE
CONSTRUCTION CONSTRUCCIÓN
RENEWAL KITS JUEGOS DE PIEZAS REPUÉSTO

4300M • 4300A 6-point Deep Sockets Vasos Hexagonales Largos

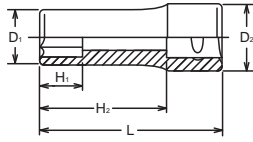
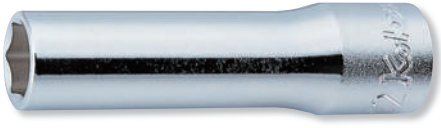

4300M 4305M (mm)	D ₁ (mm)	D ₂ (mm)	H ₁ (mm)	H ₂ (mm)	L (mm)	(g)	(pcs.)
8	13.2	21	9	59	77	76	10
9	13.8	21	10	59	77	82	10
10	15.3	21	11	59	77	82	10
11	16.5	21	12	59	77	86	10
12	17.8	21	13	59	77	92	10
13	19	21.8	14	59	77	106	10
14	20.3	21.8	15	59	77	115	10
15	21.5	21.8	16	59	77	123	10
16	22.8	22	17	59	77	141	10
17	24	23	18	59	77	139	10
18	25	24	19	59	77	149	10
19	26.5	25	20	58	77	165	10
20	27.8	26	21	58	77	183	10
21	29	27	23	58	77	190	10
22	30	28	27	57	77	200	10
23	31.5	29	27	57	77	233	10
24	32.8	30	27	57	77	249	10
25	34	31	27	57	77	270	10
26	35	32	27	56	77	279	10
27	36.5	33	28	56	77	303	10
28	37.8	34	28	56	77	331	10
29	39	35	28	55	77	357	10
30	40	36	34	55	77	342	10
31	41.5	37	34	55	77	384	10
32	42.8	38	34	55	77	405	10
33	44.2	39	35	54	77	420	5
34	45.2	40	35	54	77	442	5
35	46.2	40	35	53	77	458	5
36	47.2	41	35	53	77	484	5
37	48.2	42	38	53	77	475	5
38	49	44	38	53	77	490	5

4305M • 4305A 12-point Deep Sockets Vasos Bihexagonales Largos

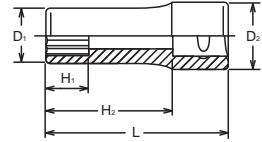

4300A 4305A (inch)	D ₁ (mm)	D ₂ (mm)	H ₁ (mm)	H ₂ (mm)	L (mm)	(g)	(pcs.)
5/16	13.2	21	9	59	77	76	10
3/8	14.6	21	10	59	77	82	10
7/16	16.5	21	12	59	77	86	10
1/2	19	21.8	14	59	77	106	10
9/16	20.3	21.8	15	59	77	115	10
19/32	21.5	21.8	16	59	77	123	10
5/8	22.8	22	17	59	77	141	10
21/32	24	23	18	59	77	139	10
11/16	25	24	19	59	77	149	10
3/4	26.5	25	20	58	77	165	10
25/32	27.8	26	21	58	77	183	10
13/16	29	27	23	58	77	190	10
7/8	30	28	27	57	77	200	10
15/16	32.8	30	27	57	77	249	10
31/32	34	31	27	57	77	270	10
1	35	32	27	56	77	279	10
1. 1/16	36.5	33	28	56	77	303	10
1. 1/8	37.8	34	28	56	77	331	10
1. 3/16	40	36	34	55	77	342	10
1. 1/4	42.8	38	34	55	77	405	10
1. 5/16	44.2	39	35	54	77	420	5
1. 3/8	46.2	40	35	54	77	422	5
1. 7/16	47.2	41	35	53	77	484	5
1. 1/2	49	44	38	53	77	523	5
1.13/16	59	48	38	51	77	791	5

RS4300M/10 Socket Set on Rail Juego de Vasos en Regleta

RS4305M/10

RS4300A/10 Socket Set on Rail Juego de Vasos en Regleta

RS4305A/10



RS4300M/10	10 Pieces Set/Rail 300mm	 (g)
10, 11, 12, 13, 14, 15, 17, 19, 21, 22		1,415

RS4305M/10	10 Pieces Set/Rail 300mm	 (g)
10, 11, 12, 13, 14, 15, 17, 19, 21, 22		1,415

RS4300A/10	10 Pieces Set/Rail 300mm	 (g)
3/8, 7/16, 1/2, 9/16, 5/8, 11/16, 3/4, 13/16, 7/8, 15/16		1,600

RS4305A/10	10 Pieces Set/Rail 300mm	 (g)
3/8, 7/16, 1/2, 9/16, 5/8, 11/16, 3/4, 13/16, 7/8, 15/16		1,600

4300M (L120) 6-point Extra Deep Sockets Vasos Hexagonales Extra Largos

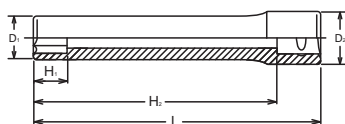

4300M(L120) (mm)	D ₁ (mm)	D ₂ (mm)	H ₁ (mm)	H ₂ (mm)	L (mm)	(g)	(pcs.)
8	13.2	21	9	102	120	120	5
10	15.3	21	11	102	120	138	5
12	17.8	21	13	102	120	157	5
14	20.3	21.8	15	102	120	193	5
16	22.8	22	17	102	120	210	5

4310M (mm)	D ₁ (mm)	D ₂ (mm)	H ₁ (mm)	H ₂ (mm)	L (mm)	(g)	(pcs.)
8	13.2	21	9	59	77	79	10
9	13.8	21	10	59	77	82	10
10	15.3	21	11	59	77	82	10
11	16.5	21	12	59	77	86	10
12	17.8	21	13	59	77	92	10
13	19	21.8	14	59	77	106	10
14	20.3	21.8	15	59	77	115	10
15	21.5	21.8	16	59	77	123	10
16	22.8	22	17	59	77	141	10
17	24	23	18	59	77	139	10
18	25	24	19	59	77	149	10
19	26.5	25	20	58	77	165	10
20	27.8	26	21	58	77	183	10
21	29	27	23	58	77	190	10
22	30	28	27	57	77	200	10
23	31.5	29	27	57	77	233	10
24	32.8	30	27	57	77	249	10
25	34	31	27	57	77	270	10
26	35	32	27	56	77	279	10
27	36.5	33	28	56	77	303	10
28	37.8	34	28	56	77	334	10
29	39	35	28	55	77	357	10
30	40	36	34	55	77	342	10
31	41.5	37	34	55	77	384	10
32	42.8	38	34	55	77	405	10
34	45.2	40	35	54	77	442	5

RS4310M/10	10 Pieces Set/Rail 300mm	(g)
10, 11, 12, 13, 14, 15, 17, 19, 21, 22		1,415

4325 (E)	D ₁ (mm)	D ₂ (mm)	H ₁ (mm)	H ₂ (mm)	L (mm)	(g)	(pcs.)
E 8	10.7	21	7	59	77	68	10
E10	13.2	21	8.2	59	77	99	10
E11	13.8	21	8.7	59	77	84	10
E12	14.6	21	9.3	59	77	99	10
E14	16.5	21	10.6	59	77	103	10
E16	19	21.8	11.8	59	77	107	10
E18	20.3	21.8	13	59	77	118	10
E20	22.8	22	14.4	59	77	141	10
E22	25	24	15.5	59	77	188	10
E24	26.6	25	17	59	77	215	10

RS4325/7	7 Pieces Set/Rail 200mm	(g)
E10, E12, E14, E16, E18, E20, E24		900

4325(L140) (E)	D ₁ (mm)	D ₂ (mm)	H ₁ (mm)	H ₂ (mm)	L (mm)	(g)	(pcs.)
E 8	10.7	21	7	122	140	110	5
E10	13.2	21	8.2	122	140	140	5
E12	14.6	21	9.3	122	140	160	5
E14	16.5	21	10.6	122	140	180	5

4325(L140) (2B)	D ₁ (mm)	D ₂ (mm)	H ₁ (mm)	H ₂ (mm)	L (mm)	(g)	(pcs.)
E 8(2B)	10.7	21	7	122	140	110	5
E10(2B)	13.2	21	8.2	122	140	140	5
E12(2B)	14.6	21	9.3	122	140	160	5
E14(2B)	16.5	21	10.6	122	140	180	5

NUT GRIP®

Twin balls at the 6-point opening hold bolt-nut tightly for safe and reliable work.

Las dos bolas de la boca Hexagonal sujetan el perno-tuerca permitiendo un trabajo seguro y fiable.



NUT GRIP®

4310M Surface Drive Deep Sockets

Vasos Surface Drive (de Contacto Curvo) Largos

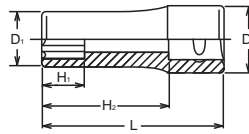

SURFACE DRIVE

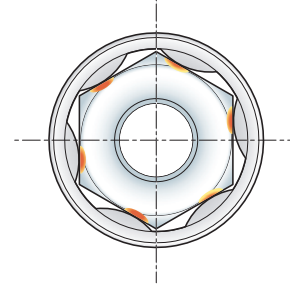

RS4310M/10 Socket Set on Rail

Juego de Vasos en Regleta



4325 TORX® Deep Sockets

Vasos TORX® Largos

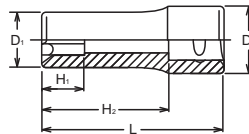

RS4325/7 Socket Set on Rail

Juego de Vasos en Regleta



4325 (L140) TORX® Extra Deep Sockets

Vasos TORX® Extra Largos

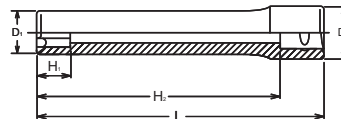

4325 (L140)-2B TORX® Extra Deep Sockets, Nut Grip®

Vasos TORX® Extra Largos, Nut Grip®

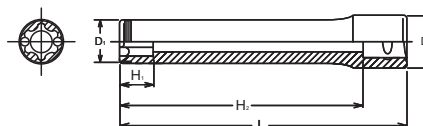

Hand Sockets 1/2"

Z-SERIES
HAND
MANUALES

TITANIUM
DE TITANIO

ACCESSORIES
ACCESORIOS

SCREWDRIVERS
DESTORNILLADORES

IMPACT
DE IMPACTO

SLEEVE-DRIVE
SLEEVES

INDUSTRIAL
INDUSTRIALES

PROTECTOR
PROTECTORES

AUTOMOTIVE

CONSTRUCTION
CONSTRUCCIÓN

RENEWAL KITS
JUEGOS DE PIEZAS/REPUES

4440M • 4440A 6-point Universal Sockets Vasos Hexagonales con Articulación Universal

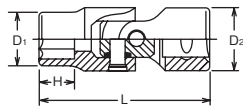

4440A (inch)	D ₁ (mm)	D ₂ (mm)	H (mm)	L (mm)	(g)	(pcs.)
3/8	14.8	25	8.8	63	155	10
7/16	16.5	25	10	65	158	10
1/2	19	25	11.4	66	152	10
9/16	20.3	25	11.4	66	151	10
5/8	22.8	25	13	68	150	10
11/16	24.6	25	14	69	153	10
3/4	26.5	25	15	71	170	10
7/8	30.3	25	16	72	185	5

4440M (mm)	D ₁ (mm)	D ₂ (mm)	H (mm)	L (mm)	(g)	(pcs.)
9	14	25	8.3	63	150	10
10	15.3	25	8.8	63	155	10
11	16.5	25	10	65	158	10
12	17.8	25	10.5	65	151	10
13	19	25	11.4	66	152	10
14	20.3	25	11.4	66	151	10
15	21.5	25	13	68	149	10
16	22.8	25	13	68	150	10
17	24	25	14	69	150	10
18	25.3	25	14	69	150	10
19	26.5	25	15	71	170	10
20	27.8	25	15	71	173	5
21	29	25	16	72	176	5
22	30.3	25	16	72	185	5

4445M • 4445A 12-point Universal Sockets Vasos Bihexagonales con Articulación Universal

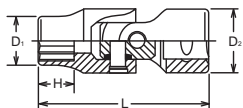

4445A (inch)	D ₁ (mm)	D ₂ (mm)	H (mm)	L (mm)	(g)	(pcs.)
New 3/8	14.8	25	8.8	63	155	10
New 7/16	16.5	25	10	65	158	10
New 1/2	19	25	11.4	66	152	10
New 9/16	20.3	25	11.4	66	151	10
New 5/8	22.8	25	13	68	150	10
New 11/16	24.6	25	14	69	153	10

4445M (mm)	D ₁ (mm)	D ₂ (mm)	H (mm)	L (mm)	(g)	(pcs.)
New 10	15.3	25	8.8	63	155	10
New 12	17.8	25	10.5	65	151	10
New 13	19	25	11.4	66	152	10
New 14	20.3	25	11.4	66	151	10
New 17	24	25	14	69	150	10
New 19	26.5	25	15	71	170	10
New 21	29	25	16	72	176	5
New 22	30.3	25	16	72	185	5

4440T TORX® Universal Sockets Vasos TORX® con Articulación Universal

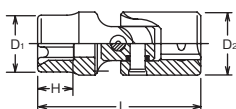

4440T (E)	D ₁ (mm)	D ₂ (mm)	H (mm)	L (mm)	(g)	(pcs.)
E10	13.2	25	8.2	62	145	10
E12	15	25	9.3	63	147	10
E14	16.3	25	10.6	65	148	10
E16	18.8	25	11.8	65	150	10
E18	20.4	25	13	67	153	10

4117M-125 • -250 Extension Deep Sockets Vasos con Alargaderas

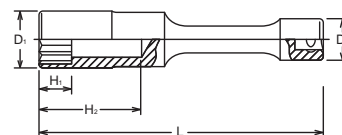

4117M.125 (mm)	D ₁ (mm)	D ₂ (mm)	H ₁ (mm)	H ₂ (mm)	L (mm)	(g)	(pce.)
13	18.7	24	13	59	125	213	1
14	20.2	24	14	59	125	227	1
17	24	24	17	59	125	274	1
19	26.9	24	19	59	125	279	1
21	28.5	24	21	59	125	291	1
22	30	24	22	59	125	323	1
24	32	24	24	59	125	361	1
27	36.5	24	27	59	125	439	1
30	40	24	30	59	125	461	1
32	42	24	32	59	125	498	1

4117M.250 (mm)	D ₁ (mm)	D ₂ (mm)	H ₁ (mm)	H ₂ (mm)	L (mm)	(g)	(pce.)
13	18.7	24	13	59	250	412	1
14	20.2	24	14	59	250	423	1
17	24	24	17	59	250	469	1
19	26.9	24	19	59	250	484	1
21	28.5	24	21	59	250	496	1
22	30	24	22	59	250	516	1
24	32	24	24	59	250	560	1
27	36.5	24	27	59	250	641	1
30	40	24	30	59	250	663	1
32	42	24	32	59	250	698	1

4000 (PH)	D (mm)	H (mm)	L (mm)	(g)	(pcs.)
2	22	23.5	60	65	10
3	22	23.5	60	65	10
4	22	23.5	60	67	10

4000.60 (PZ)	D (mm)	H (mm)	L (mm)	(g)	(pcs.)
PZ2	22	23.5	60	65	10
PZ3	22	23.5	60	65	10

4005	TxW (mm)	D (mm)	H (mm)	L (mm)	(g)	(pcs.)
8	1.2x 8	22	23.5	60	65	10
10	1.6x10	22	23.5	60	75	10
12	2.0x12	23	23.5	60	111	10
14	2.5x14	24	23.5	60	133	10
16	2.5x16	24	23.5	60	133	10

4001 (PH)	D (mm)	H (mm)	L (mm)	(g)	(pcs.)
1	21	38	60	49	10
2	21	38	60	53	10
3	21	38	60	55	10
4	21	38	60	57	10

4006	TxW (mm)	D (mm)	H (mm)	L (mm)	(g)	(pcs.)
5	1.0x 5.5	21	38	60	53	10
8	1.2x 8	21	38	60	62	10
10	1.6x10	21	38	60	67	10
12	2.0x12	21	38	60	72	10
14	2.5x14	21	38	60	81	10
16	2.5x16	21	38	60	88	10

 4001, 4006 are for hand use only. Do not use with an impact wrench.

4000-60 (PH) Phillips Bit Sockets Vasos con Punta Phillips

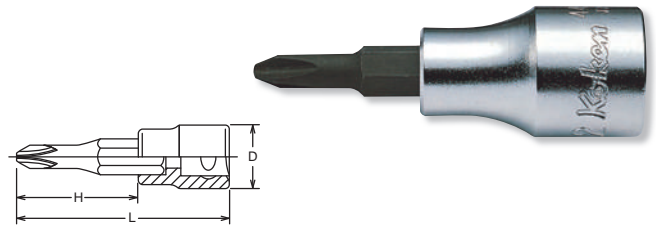

4000-60 (PZ) PZ Bit Sockets Vasos con Punta PZ

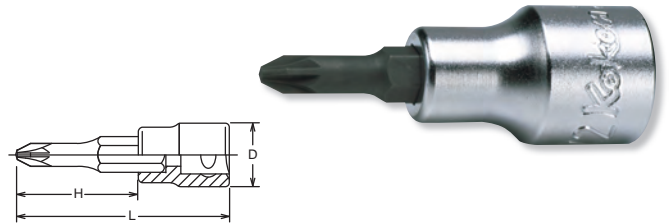

4005-60 Slotted Bit Sockets Vasos con Punta Recta para Cabezas Ranuradas

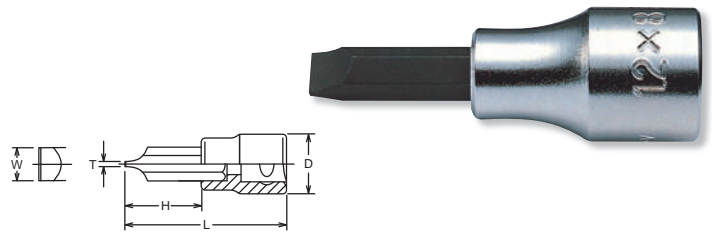

4001 Phillips Bit Sockets Vasos con Punta Phillips



4006 Slotted Bit Sockets Vasos con Punta Recta para Cabezas Ranuradas

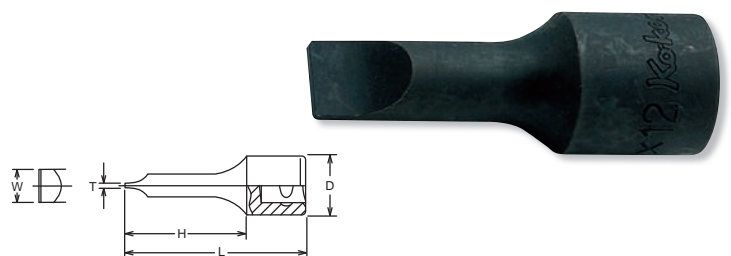

Z-SERIES
HAND
MANUALES
TITANIUM
DE TITANIO
ACCESSORIES
ACCESORIOS
SCREWDRIVERS
DESTORNILLADORES
IMPACT
DE IMPACTO
SLEEVE-DRIVE
INDUSTRIAL
INDUSTRIALES
PROTECTOR
PROTECTORES
AUTOMOTIVE
CONSTRUCTION
CONSTRUCCION
RENEWAL KITS
JUEGOS DE HERRAMIENTAS

Hand Sockets 1/2"

Z-SERIES
HAND
MANUALES

TITANIUM
DE TITANIO

ACCESSORIES
ACCESORIOS

IMPACT
DE IMPACTO

SLEEVE-DRIVE
SLEEVES

INDUSTRIAL
INDUSTRIALES

PROTECTOR
PROTECTORES

AUTOMOTIVE

CONSTRUCTION
CONSTRUCCIÓN

4010M-50 · -75 · -100 · -160 4010A-60

 Inhex Bit Sockets
Vasos con Punta Hexagonal

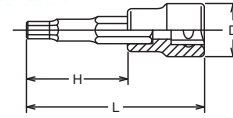
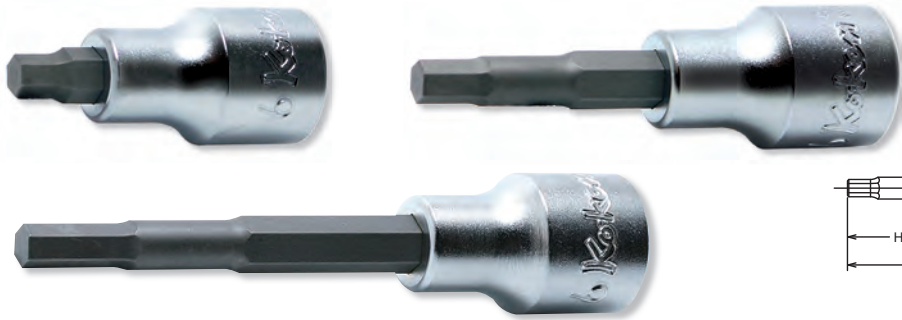

4010M.50 (mm)	D (mm)	H (mm)	L (mm)	(g)	(pcs.)
4	22	13.5	50	61	10
5	22	13.5	50	62	10
6	22	13.5	50	64	10
7	22	13.5	50	65	10
8	22	13.5	50	66	10
9	22	13.5	50	73	10
10	22	13.5	50	75	10
12	23	13.5	50	105	10
13	24	13.5	50	120	10
14	24	13.5	50	120	10
16	25	15	50	150	10
17	25	15	50	150	10
18	27	15	50	200	5
19	27	15	50	200	5

4010M.100 (mm)	D (mm)	H (mm)	L (mm)	(g)	(pcs.)
4	22	63.5	100	77	10
5	22	63.5	100	78	10
6	22	63.5	100	80	10
7	22	63.5	100	82	10
8	22	63.5	100	84	10
9	22	63.5	100	105	10
10	22	63.5	100	109	10
12	23	63.5	100	155	10
13	24	63.5	100	180	5
14	24	63.5	100	180	5
16	25	60	100	250	5
17	25	60	100	250	5
18	27	58	100	300	5
19	27	58	100	300	5

4010M.75 (mm)	D (mm)	H (mm)	L (mm)	(g)	(pcs.)
4	22	38.5	75	69	10
5	22	38.5	75	70	10
6	22	38.5	75	72	10
7	22	38.5	75	73	10
8	22	38.5	75	74	10
9	22	38.5	75	90	10
10	22	38.5	75	92	10
12	23	38.5	75	130	10
13	24	38.5	75	150	10
14	24	38.5	75	150	10
16	25	35	75	180	10
17	25	35	75	180	10
18	27	33	75	230	5
19	27	33	75	230	5

4010M.160 (mm)	D (mm)	H (mm)	L (mm)	(g)	(pcs.)
4	22	123.5	160	103	10
5	22	123.5	160	104	10
6	22	123.5	160	106	10
7	22	123.5	160	108	10
8	22	123.5	160	110	10
10	22	123.5	160	126	10
12	23	123.5	160	180	5
14	24	123.5	160	260	5
17	25	120	160	360	5
19	27	118	160	415	5

4010A.60 (inch)	D (mm)	H (mm)	L (mm)	(g)	(pcs.)
5/32	22	23.5	60	57	10
3/16	22	23.5	60	57	10
7/32	22	23.5	60	59	10
1/4	22	23.5	60	63	10
9/32	22	23.5	60	65	10
5/16	22	23.5	60	67	10
11/32	22	23.5	60	75	10
3/8	22	23.5	60	76	10
7/16	23	23.5	60	101	10
1/2	24	23.5	60	124	10
9/16	25	20	60	127	10
5/8	25	20	60	174	10
3/4	27	18	60	220	5



RS4010M/10-L50 RS4010M/10-L75 RS4010A/10-L60

 Socket Set on Rail
Juego de Vasos en Regleta



RS4010M/10-L50	10 Pieces Set/Rail 300mm	(g)
4, 5, 6, 7, 8, 10, 12, 14, 17, 19		968

RS4010M/10-L75	10 Pieces Set/Rail 300mm	(g)
4, 5, 6, 7, 8, 10, 12, 14, 17, 19		1,207

RS4010A/10-L60	10 Pieces Set/Rail 300mm	(g)
3/16, 7/32, 1/4, 5/16, 3/8, 7/16, 1/2, 9/16, 5/8, 3/4		1,080

1/2" Hand Sockets

4020-60 · -100 · -120 · -140

XZN Bit Sockets
Vasos con Punta XZN

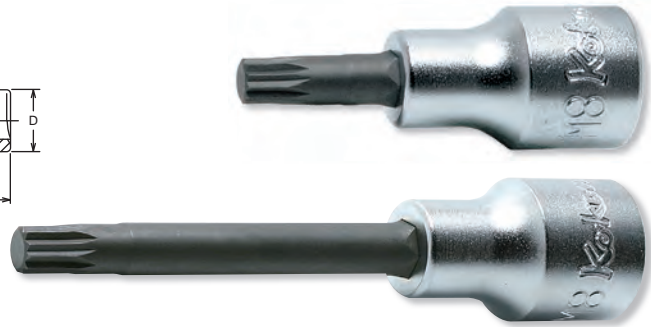
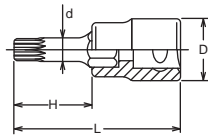

4020.60 (XZN)	D (mm)	d (mm)	H (mm)	L (mm)	(g)	(pcs.)
M 5	22	7.8	23.5	60	60	10
M 6	22	7.8	23.5	60	61	10
M 8	22	7.8	23.5	60	63	10
M10	23	11.9	23.5	60	93	10
M12	23	11.9	23.5	60	97	10
M14	24	13.9	23.5	60	105	10
M16	25	16.9	20	60	165	10
M18	27	17.9	20	60	215	5

4020.100 (XZN)	D (mm)	d (mm)	H (mm)	L (mm)	(g)	(pcs.)
M 5	22	7.8	63.5	100	77	10
M 6	22	7.8	63.5	100	78	10
M 8	22	7.8	63.5	100	80	10
M10	23	11.9	63.5	100	132	10
M12	23	11.9	63.5	100	136	10
M14	24	13.9	63.5	100	144	5
M16	25	16.9	60	100	250	5
M18	27	17.9	60	100	300	5

4020.120 (XZN)	D (mm)	d (mm)	H (mm)	L (mm)	(g)	(pcs.)
M 5	22	7.8	83.5	120	86	10
M 6	22	7.8	83.5	120	87	10
M 8	22	7.8	83.5	120	89	10
M10	23	11.9	83.5	120	152	10
M12	23	11.9	83.5	120	156	10
M14	24	13.9	83.5	120	164	5

4020.140 (XZN)	D (mm)	d (mm)	H (mm)	L (mm)	(g)	(pcs.)
M 5	22	7.8	103.5	140	95	10
M 6	22	7.8	103.5	140	96	10
M 8	22	7.8	103.5	140	98	10
M10	23	11.9	103.5	140	172	5
M12	23	11.9	103.5	140	176	5
M14	24	13.9	103.5	140	184	5

XZN

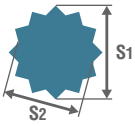

XZN		M4	M5	M6	M8	M10	M12	M14	M16	M18
S ₁	(ref. mm)	3.6	4.8	6.1	7.3	9.7	11.5	13.3	15.7	16.9
S ₂	(ref. mm)	3.1	4.1	5.1	6.1	8.1	9.7	11.2	13.2	14.2

RS4020/6-L60	6 Pieces Set/Rail 150mm	(g)
M5, M6, M8, M10, M12, M14		500

RS4020/6-L60



Socket Set on Rail
Juego de Vasos en Regleta



	Phillips (PH)	PZ	Slotted	HEX	HEX (ball point)	Triple Square (XZN)	TORX® (T)	TORX® (TH)	TORXplus® (IP)	TORXplus® (IPR)	Ribe-CV
1/4"	No.2000 series	No.2000(PZ) series	No.2005 series	No.2010M/A series	No.2011M series	No.2020 series	No.2025 series	No.2025(TH) series	No.2025(IP) series	No.2025(IPR) series	—
3/8"	No.3000 No.3001 series	No.3000(PZ) series	No.3005 No.3006 series	No.3010M/A No.3012M/A No.3015M series	No.3011M series	No.3020 series	No.3025 series	No.3025(TH) series	No.3025(IP) series	No.3025(IPR) series	No.3027 series
1/2"	No.4000 No.4001 series	No.4000(PZ) series	No.4005 No.4006 series	No.4010M/A No.4012M/A series	—	No.4020 series	No.4025 series	—	No.4025(IP) series	—	No.4027 series

Z-SERIES
HAND MANUALES
TITANIUM DE TITANIO
ACCESSORIES ACCESORIOS
SCREWDRIVERS DESTORNILLADORES
IMPACT DE IMPACTO
SLEEVE-DRIVE
INDUSTRIAL INDUSTRIALES
PROTECTOR PROTECTORES
AUTOMOTIVE
CONSTRUCTION CONSTRUCCION
RENEWAL KITS JUEGOS DE HERRAMIENTAS

Hand Sockets 1/2"

Z-SERIES
HAND MANUALES
TITANIUM DE TITANIO
ACCESSORIES ACCESORIOS
IMPACT DE IMPACTO
SLEEVE-DRIVE
INDUSTRIAL INDUSTRIALES
PROTECTOR PROTECTORES
AUTOMOTIVE
CONSTRUCTION CONSTRUCCIÓN
RENEWAL KITS JUEGOS DE PIEZAS REPUESTO

4025-60 · -100 · -140 (T)

 TORX® Bit Sockets
Vasos con Punta TORX®

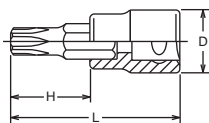

4025.60 (T)	D (mm)	H (mm)	L (mm)	(g)	(pcs.)
T15	22	23.5	60	58	10
T20	22	23.5	60	59	10
T25	22	23.5	60	60	10
T27	22	23.5	60	60	10
T30	22	23.5	60	60	10
T40	22	23.5	60	62	10
T45	22	23.5	60	64	10
T50	22	23.5	60	74	10
T55	23	23.5	60	96	10
T60	24	23.5	60	122	10
T70	24	23.5	60	135	10
T80	24	20	60	168	10

4025.100 (T)	D (mm)	H (mm)	L (mm)	(g)	(pcs.)
T20	22	73.5	100	76	10
T25	22	73.5	100	76	10
T27	22	73.5	100	77	10
T30	22	73.5	100	77	10
T40	22	73.5	100	78	10
T45	22	73.5	100	80	10
T50	22	73.5	100	98	10
T55	23	73.5	100	132	10
T60	24	73.5	100	170	5
T70	24	73.5	100	175	5

4025.140 (T)	D (mm)	H (mm)	L (mm)	(g)	(pcs.)
T20	22	103.5	140	94	10
T25	22	103.5	140	95	10
T27	22	103.5	140	95	10
T30	22	103.5	140	95	10
T40	22	103.5	140	97	10
T45	22	103.5	140	99	10
T50	22	103.5	140	129	10
T55	23	103.5	140	175	5
T60	24	103.5	140	229	5
T70	24	103.5	140	245	5
T80	24	100	140	320	5

RS4025/9-L60

  Socket Set on Rail
Juego de Vasos en Regleta



RS4025/9-L60	9 Pieces Set/Rail 250mm	(g)
T20, T25, T27, T30, T40, T45, T50, T55, T60		700

TORX®
(T)

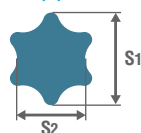

	T	T8	T9	T10	T15	T20	T25	T27	T30	T40	T45	T50	T55	T60	T70	T80	T90	T100
S ₁	(ref. mm)	2.3	2.5	2.7	3.3	3.9	4.5	5.0	5.6	6.7	7.9	8.9	11.3	13.3	15.6	17.6	20.0	22.2
S ₂	(ref. mm)	1.7	1.8	2.0	2.3	2.8	3.2	3.6	4.0	4.8	5.6	6.2	8.0	9.5	11.1	12.7	14.2	15.8

4025-60-T35

 Bit Socket
Vasos con Punta

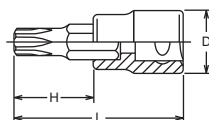

4025.60	D (mm)	H (mm)	L (mm)	(g)	(pcs.)
T35	22	23.5	60	96	10

1/2" Hand Sockets

4025.60 (IP)	D (mm)	H (mm)	L (mm)	(g)	(pcs.)
20IP	22	23.5	60	60	10
25IP	22	23.5	60	60	10
27IP	22	23.5	60	60	10
30IP	22	23.5	60	60	10
40IP	22	23.5	60	60	10
45IP	22	23.5	60	64	10
50IP	22	23.5	60	74	10
55IP	23	23.5	60	96	10
60IP	24	23.5	60	122	10
70IP	24	23.5	60	170	10

4025.100 (IP)	D (mm)	H (mm)	L (mm)	(g)	(pcs.)
40IP	22	63.5	100	79	10
45IP	22	63.5	100	81	10
50IP	22	63.5	100	100	10
55IP	23	63.5	100	133	10
60IP	24	63.5	100	172	5
70IP	25	63.5	100	241	5

RS4025/9-IP	9 Pieces set/Rail 250mm	(g)
20IP, 25IP, 27IP, 30IP, 40IP, 45IP, 50IP, 55IP, 60IP		700

4025-60 · -100 (IP) TORXPLUS® Bit Sockets Vasos con Punta TORXPLUS®

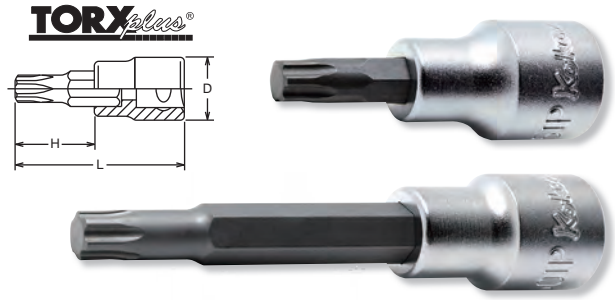

RS4025/9-IP Socket Set on Rail Juego de Vasos en Regleta



TORXPLUS® (IP)

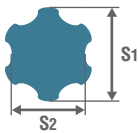

IP		8IP	9IP	10IP	15IP	20IP	25IP	27IP	30IP	40IP	45IP	50IP	55IP	60IP	70IP
S ₁	(ref. mm)	2.3	2.5	2.7	3.3	3.9	4.5	5.0	5.6	6.7	7.9	8.9	11.3	13.3	15.6
S ₂	(ref. mm)	1.7	1.8	2.0	2.3	2.8	3.2	3.6	4.0	4.8	5.6	6.2	8.0	9.5	11.1

4027.60	D (mm)	H (mm)	L (mm)	(g)	(pcs.)
M 5	22	23.5	60	60	10
M 6	22	23.5	60	62	10
M 7	22	23.5	60	63	10
M 8	22	23.5	60	64	10
M 9	22	23.5	60	70	10
M10	22	23.5	60	74	10
M12	23	23.5	60	96	10
M13	24	23.5	60	116	10
M14	24	23.5	60	122	10
M16	24	25	60	135	10

4027.100	D (mm)	H (mm)	L (mm)	(g)	(pcs.)
M 5	22	63.5	100	67	10
M 6	22	63.5	100	68	10
M 7	22	63.5	100	75	10
M 8	22	63.5	100	81	10
M 9	22	63.5	100	90	10
M10	22	63.5	100	101	10
M12	23	63.5	100	134	10
M13	24	63.5	100	155	5
M14	24	63.5	100	173	5
M16	24	60	100	241	5

4027.140	D (mm)	H (mm)	L (mm)	(g)	(pcs.)
M 8	22	103.5	140	98	10
M10	22	103.5	140	127	10
M12	23	103.5	140	171	5
M14	24	103.5	140	226	5
M16	24	100	140	320	5

RS4027/6-L60	6 Pieces set/Rail 200mm	(g)
M5, M6, M8, M10, M12, M14		600

4027-60 · -100 · -140 Bit Sockets for Ribe Screws Vasos con Punta para Tornillos Ribe

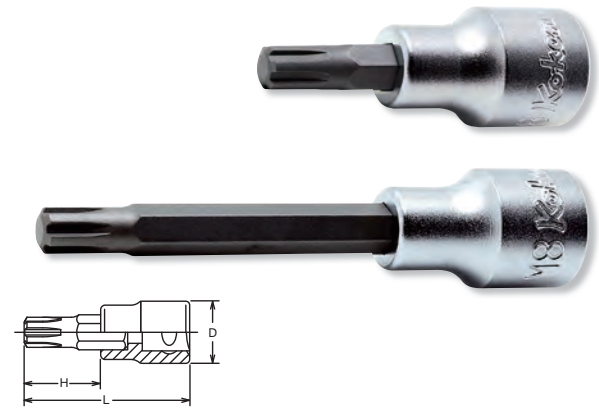

RS4027/6-L60 Socket Set on Rail Juego de Vasos en Regleta



Ribe CV

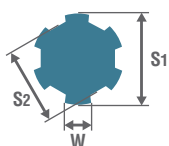



CV		M5	M6	M7	M8	M9	M10	M12	M13	M14	M16
W	(ref. mm)	1.2	1.3	1.4	1.8	2.0	2.3	2.6	3.1	3.2	3.6
S ₁	(ref. mm)	5.0	6.0	7.0	8.0	9.0	10.0	12.0	13.0	14.0	16.0
S ₂	(ref. mm)	3.8	4.5	5.0	6.0	7.1	7.4	9.0	11.0	10.4	11.9

Z-SERIES
HAND
MANUALES
TITANIUM
DE TITANIO
ACCESSORIES
ACCESORIOS
SCREWDRIVERS
DESTORNILLADORES
IMPACT
DE IMPACTO
SLEEVE-DRIVE
INDUSTRIAL
INDUSTRIALES
PROTECTOR
PROTECTORES
AUTOMOTIVE
CONSTRUCTION
CONSTRUCCION
RENEWAL KITS
JUEGOS DE PIEZAS/REPLUESTO

Hand Sockets 1/2"

Z-SERIES
HAND MANUALES
TITANIUM DE TITANIO
ACCESSORIES ACCESORIOS
IMPACT DE IMPACTO
SLEEVE-DRIVE
INDUSTRIAL INDUSTRIALES
PROTECTOR PROTECTORES
AUTOMOTIVE
CONSTRUCTION CONSTRUCCIÓN
RENEWAL KITS JUEGOS DE PIEZAS REPUÉS

4012M-43 · -60 · -75 · -100

 Inhex Sockets
Vasos con Punta de Hexagonal 

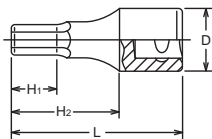

4012M.43 (mm)	D (mm)	H ₁ (mm)	H ₂ (mm)	L (mm)	(g)	(pcs.)
4	21.1	11.5	23	43	40	10
5	21.1	11.5	23	43	46	10
6	21.1	11.5	23	43	42	10
7	21.1	11.5	23	43	46	10
8	21.1	11.5	23	43	49	10
9	21.1	11.5	23	43	63	10
10	23	11.5	23	43	63	10
11	25	11.5	23	43	74	10
12	25	11.5	23	43	81	10
13	25	11.5	23	43	85	10
14	25	11.5	23	43	88	10
15	26	11.5	23	43	91	10
16	26	11.5	23	43	100	10
17	26	11.5	23	43	101	10
18	26	11.5	23	43	106	10
19	26	11.5	23	43	110	10
20	26	11.5	23	43	130	10
21	26	11.5	23	43	140	10
22	26	11.5	23	43	145	10
23	28	11.5	23	43	167	10
24	28	11.5	23	43	170	10
27	32	11.5	23	43	226	10

4012M.75 (mm)	D (mm)	H ₁ (mm)	H ₂ (mm)	L (mm)	(g)	(pcs.)
4	21.1	15.5	53	75	52	10
5	21.1	15.5	53	75	58	10
6	21.1	15.5	53	75	62	10
7	21.1	15.5	53	75	70	10
8	21.1	15.5	53	75	74	10
9	21.1	15.5	53	75	88	10
10	23	15.5	53	75	94	10
11	25	15.5	53	75	119	10
12	25	15.5	53	75	122	10
13	25	15.5	53	75	137	10
14	25	15.5	53	75	148	10
15	26	15.5	53	75	151	10
16	26	15.5	53	75	171	10
17	26	15.5	53	75	184	10
18	26	15.5	53	75	196	10
19	26	15.5	53	75	212	10
22	26	22.5	53	75	266	10
24	27.9	22.5	53	75	315	10

4012M.60 (mm)	D (mm)	H ₁ (mm)	H ₂ (mm)	L (mm)	(g)	(pcs.)
4	21.1	15.5	38	60	49	10
5	21.1	15.5	38	60	55	10
6	21.1	15.5	38	60	56	10
7	21.1	15.5	38	60	60	10
8	21.1	15.5	38	60	64	10
9	21.1	15.5	38	60	78	10
10	23	15.5	38	60	78	10
11	25	15.5	38	60	100	10
12	25	15.5	38	60	107	10
13	25	15.5	38	60	111	10
14	25	15.5	38	60	122	10
15	26	15.5	38	60	125	10
16	26	15.5	38	60	134	10
17	26	15.5	38	60	141	10
18	26	15.5	38	60	153	10
19	26	15.5	38	60	159	10
21	26	15.5	38	60	197	10
22	26	22.5	38	60	205	10
23	28	22.5	38	60	242	10
24	28	22.5	38	60	245	10

4012M.100 (mm)	D (mm)	H ₁ (mm)	H ₂ (mm)	L (mm)	(g)	(pcs.)
4	24	15.5	78	100	75	10
5	24	15.5	78	100	81	10
6	24	15.5	78	100	85	10
7	24	15.5	78	100	93	10
8	24	15.5	78	100	97	10
9	24	15.5	78	100	111	10
10	24	15.5	78	100	117	10
11	24	15.5	78	100	142	10
12	24	15.5	78	100	143	10
13	24	15.5	78	100	158	10
14	24	15.5	78	100	169	10
15	24	15.5	78	100	172	10
16	24	15.5	78	100	192	5
17	24	15.5	78	100	215	5
18	24	15.5	78	100	227	5
19	24	15.5	78	100	243	5

RS4012M/10-L60



 Socket Set on Rail
Juego de Vasos en Regleta



RS4012M/10-L60	10 Pieces set/Rail 300mm	(g)
4, 5, 6, 7, 8, 10, 12, 14, 17, 19		910

 4012M/A are for hand use only.
Do not use with an impact wrench.

4012A-43 · -60 · -75 · -100

 Inhex Sockets
Vasos Inhex 

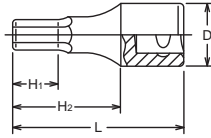

4012A.43 (inch)	D (mm)	H ₁ (mm)	H ₂ (mm)	L (mm)	(g)	(pcs.)
5/32	21.1	11.5	23	43	40	10
3/16	21.1	11.5	23	43	46	10
7/32	21.1	11.5	23	43	42	10
1/4	21.1	11.5	23	43	43	10
9/32	21.1	11.5	23	43	46	10
5/16	21.1	11.5	23	43	49	10
11/32	21.1	11.5	23	43	63	10
3/8	23	11.5	23	43	59	10
7/16	25	11.5	23	43	74	10
1/2	25	11.5	23	43	85	10
9/16	25	11.5	23	43	88	10
5/8	26	11.5	23	43	100	10
3/4	26	11.5	23	43	110	10
7/8	26	11.5	23	43	141	10

4012A.60 (inch)	D (mm)	H ₁ (mm)	H ₂ (mm)	L (mm)	(g)	(pcs.)
5/32	21.1	15.5	38	60	49	10
3/16	21.1	15.5	38	60	55	10
7/32	21.1	15.5	38	60	56	10
1/4	21.1	15.5	38	60	57	10
9/32	21.1	15.5	38	60	60	10
5/16	21.1	15.5	38	60	64	10
11/32	21.1	15.5	38	60	78	10
3/8	23	15.5	38	60	74	10
7/16	25	15.5	38	60	100	10
1/2	25	15.5	38	60	111	10
9/16	25	15.5	38	60	122	10
5/8	26	15.5	38	60	134	10
3/4	26	15.5	38	60	159	10
7/8	26	22.5	38	60	202	10

4012A.75 (inch)	D (mm)	H ₁ (mm)	H ₂ (mm)	L (mm)	(g)	(pcs.)
5/32	21.1	15.5	53	75	52	10
3/16	21.1	15.5	53	75	58	10
7/32	21.1	15.5	53	75	62	10
1/4	21.1	15.5	53	75	65	10
9/32	21.1	15.5	53	75	70	10
5/16	21.1	15.5	53	75	74	10
11/32	21.1	15.5	53	75	88	10
3/8	23	15.5	53	75	86	10
7/16	25	15.5	53	75	119	10
1/2	25	15.5	53	75	137	10
9/16	25	15.5	53	75	148	10
5/8	26	15.5	53	75	171	10
3/4	26	15.5	53	75	212	10
7/8	26	22.5	53	75	262	10

4012A.100 (inch)	D (mm)	H ₁ (mm)	H ₂ (mm)	L (mm)	(g)	(pcs.)
5/32	24	15.5	78	100	75	10
3/16	24	15.5	78	100	81	10
7/32	24	15.5	78	100	85	10
1/4	24	15.5	78	100	88	10
9/32	24	15.5	78	100	93	10
5/16	24	15.5	78	100	97	10
11/32	24	15.5	78	100	111	10
3/8	24	15.5	78	100	109	10
7/16	24	15.5	78	100	142	10
1/2	24	15.5	78	100	158	10
9/16	24	15.5	78	100	169	10
5/8	24	15.5	78	100	192	5
3/4	24	15.5	78	100	243	5

RS4012A/10-L60	10 Pieces set/Rail 300mm	(g)
3/16, 7/32, 1/4, 5/16, 3/8, 7/16, 1/2, 9/16, 5/8, 3/4		950

RS4012A/10-L60



Socket Set on Rail
Juego de Vasos en Regleta



 4012M/A are for hand use only.
Do not use with an impact wrench.

Z-SERIES
HAND
MANUALES
TITANIUM
DE TITANIO
ACCESSORIES
ACCESORIOS
SCREWDRIVERS
DESTORNILLADORES
IMPACT
DE IMPACTO
SLEEVE-DRIVE
INDUSTRIAL
INDUSTRIALES
PROTECTOR
PROTECTORES
AUTOMOTIVE
CONSTRUCTION
CONSTRUCCION
RENEWAL KITS
JUEGOS DE PIEZAS/REPLUSTO

Hand Sockets 1/2"

Z-SERIES
HAND
MANUALES

TITANIUM
DE TITANIO

ACCESSORIES
ACCESORIOS

SCREWDRIVERS
DESTORNILLADORES

IMPACT
DE IMPACTO

SLEEVE-DRIVE
INDUSTRIAL

INDUSTRIAL
INDUSTRIALES

PROTECTOR
PROTECTORES

AUTOMOTIVE

CONSTRUCTION
CONSTRUCCIÓN

RENEWAL KITS
JUEGOS DE PIEZAS REPUESTO

3749S-1/2 Reversible Ratchet Short Llave de Carraca Reversible Corta



* Renewal Kits → 3749SRK-1/2 → P304

3749SB-1/2 Reversible Ratchet Short with Quick Release Button Llave de Carraca Reversible corta con botón de extracción rápida



* Renewal Kits → 3749SBRK-1/2 → P304

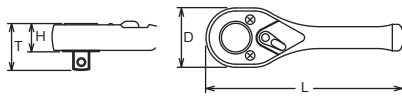

	D (mm)	T (mm)	H (mm)	L (mm)	(g)	(pcs.)
3749S-1/2	34	29	14.4	110	200	5
3749SB-1/2	34	29	14.4	110	200	5

⚠ Reversible Ratchet with quick release button has less strength compared with normal ratchet due to the technical design. Make sure to use the ratchet correctly.

4749N-250 Reversible Ratchet Llave de Carraca Reversible



* Renewal Kits → 4749RK → P304

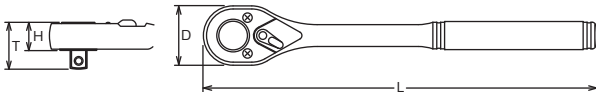

	D (mm)	T (mm)	H (mm)	L (mm)	(g)	(pce.)
4749N-250	44.6	33	18.4	250	616	1

4749N-380 Reversible Ratchet Long Llave de Carraca Reversible Larga



* Renewal Kits → 4749RK → P304



4749J-380 Reversible Ratchet Long Llave de Carraca Reversible Larga



* Renewal Kits → 4749RK → P304

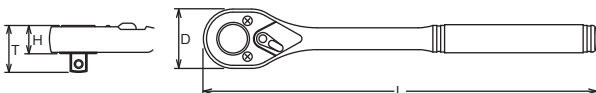

	D (mm)	T (mm)	H (mm)	L (mm)	(g)	(pce.)
4749N-380	44.6	33	18.4	380	753	1
4749J-380	44.6	33	18.4	380	743	1



[4750 series]

Two dogs are set in the same axis and the three teeth hold the ratchet gear.
The enlarged contact area produces an about 10% higher torque value and the S.O.D.H system provides smooth and light movements.

Se disponen dos trinquetes en el mismo eje y la rueda de la llave de carraca se bloquea por medio de tres dientes.
El aumento de la superficie de contacto produce un aumento del par de aproximadamente 10% y el sistema S.O.D.H permite movimientos suaves y sin esfuerzo.



* Renewal Kits → 4750RK → P304

4750N Reversible Ratchet Llave de Carraca Reversible



4750P Reversible Ratchet Llave de Carraca Reversible



* Renewal Kits → 4750RK → P304

4750J Reversible Ratchet Llave de Carraca Reversible



* Renewal Kits → 4750RK → P304

	D (mm)	T (mm)	H (mm)	L (mm)	(g)	(pce.)
4750N	38	35.9	21.3	250	548	1
4750P	38	35.9	21.3	250	553	1
4750J	38	35.9	21.3	250	508	1

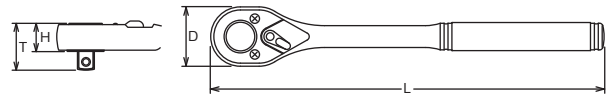

4750NB Reversible Ratchet with Quick Release Button Llave de Carraca con botón de extracción rápida ⚠



* Renewal Kits → 4750BRK → P304



4750PB Reversible Ratchet with Quick Release Button Llave de Carraca con botón de extracción rápida ⚠



* Renewal Kits → 4750BRK → P304



4750JB Reversible Ratchet with Quick Release Button Llave de Carraca con botón de extracción rápida ⚠



* Renewal Kits → 4750BRK → P304



	D (mm)	T (mm)	H (mm)	L (mm)	(g)	(pce.)
4750NB	38	35.9	21.3	250	548	1
4750PB	38	35.9	21.3	250	553	1
4750JB	38	35.9	21.3	250	508	1

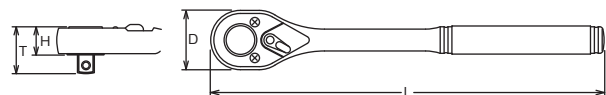

⚠ Reversible Ratchet with quick release button has less strength compared with normal ratchet due to the technical design. Make sure to use the ratchet correctly.

Z-SERIES
HAND
MANUALES
TITANIUM
DE TITANIO
ACCESSORIES
ACCESORIOS
SCREWDRIVERS
DESTORNILLADORES
IMPACT
DE IMPACTO
SLEEVE-DRIVE
INDUSTRIAL
INDUSTRIALES
PROTECTOR
PROTECTORES
AUTOMOTIVE
CONSTRUCTION
CONSTRUCCION
RENEWAL KITS
JUEGOS DE HERRAMIENTAS

Hand Sockets 1/2"

Z-SERIES
HAND MANUALES
TITANIUM DE TITANIO
ACCESSORIES ACCESORIOS
SCREWDRIVERS DESTORNILLADORES
IMPACT DE IMPACTO
SLEEVE-DRIVE
INDUSTRIAL INDUSTRIALES
PROTECTOR PROTECTORES
AUTOMOTIVE
RENEWAL KITS JUEGOS DE PIEZAS REPUSTO CONSTRUCCIÓN

4752N Reversible Ratchet
Llave de Carraca Reversible



* Renewal Kits → **4752RK** → P305

4752J Reversible Ratchet
Llave de Carraca Reversible



* Renewal Kits → **4752RK** → P305

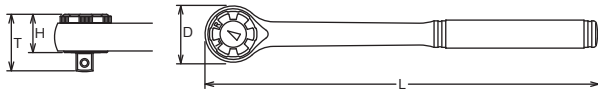

	D (mm)	T (mm)	H (mm)	L (mm)	(g)	(pce.)
4752N	35	38.8	24.5	250	480	1
4752J	35	38.8	24.5	250	470	1

[L/R Marking]



A pointer and L/R markings on the ratchet head indicate the turning direction. The reduced diameter of the head allows easier access in tight spots.

Una flecha y unas marcas L/R en el cabezal de la llave (L = Izquierda / R = Derecha) indican el sentido de giro. El diámetro reducido del cabezal permite un acceso más fácil en lugares estrechos.

4753N Reversible Ratchet
Llave de Carraca Reversible



* Renewal Kits → **4753RK** → P304

4753P Reversible Ratchet
Llave de Carraca Reversible



* Renewal Kits → **4753RK** → P304

4753J Reversible Ratchet
Llave de Carraca Reversible



* Renewal Kits → **4753RK** → P304

D4753J Reversible Ratchet
Llave de Carraca Reversible



* Renewal Kits → **4753RK** → P304

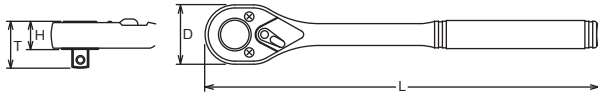

	D (mm)	T (mm)	H (mm)	L (mm)	(g)	(pce.)
4753N	38	36.2	21.6	250	595	1
4753P	38	36.2	21.6	250	570	1
4753J	38	36.2	21.6	250	545	1
D4753J	38	36.2	21.6	250	510	1

4753P-410 Reversible Ratchet Long
Llave de Carraca Reversible Larga ⚠



* Renewal Kits → **4753RK** → P304

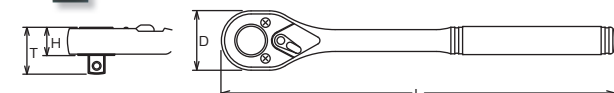

	D (mm)	T (mm)	H (mm)	L (mm)	(g)	(pce.)
4753P-410	38	36.2	21.6	410	790	1

⚠ 4753P-410 have longer handle than standard, and can be loaded to excessive torque value. In the interest of your own safety always apply load evenly and progressively to avoid breakage and possible injury.

1/2" Hand Sockets

Z-SERIES
HAND
MANUALES
TITANIUM
DE TITANIO
ACCESSORIES
ACCESORIOS
SCREWDRIVERS
DESTORNILLADORES
IMPACT
DE IMPACTO
SLEEVE-DRIVE
INDUSTRIAL
INDUSTRIALES
PROTECTOR
PROTECTORES
AUTOMOTIVE
CONSTRUCTION
RENEWAL KITS
CONSTRUCCION
JUEGOS DE PIEZAS/REPUESTO

4753NB Reversible Ratchet with Quick Release Button
Llave de Carraca Reversible con botón de extracción rápida ⚠



4753PB Reversible Ratchet with Quick Release Button
Llave de Carraca Reversible con botón de extracción rápida ⚠



4753JB Reversible Ratchet with Quick Release Button
Llave de Carraca Reversible con botón de extracción rápida ⚠



	D (mm)	T (mm)	H (mm)	L (mm)	(g)	(pce.)
4753NB	38	36.2	21.6	250	595	1
4753PB	38	36.2	21.6	250	570	1
4753JB	38	36.2	21.6	250	545	1

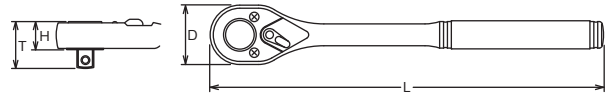

⚠ Reversible Ratchet with quick release button has less strength compared with normal ratchet due to the technical design. Make sure to use the ratchet correctly.

Reversible Ratchet with Quick Release Button :
Sockets and accessories are safely locked.
By pushing the button the sockets or extension bars are released from the ratchet.

Llave de Carraca Reversible con Botón de Extracción Rápida : Los vasos y accesorios se bloquean en posición. Los vasos o las alargaderas se extraen de la llave apretando el botón.



GEAR TEETH



4749series



4753series



4750series



4752series



4774series



Hand Sockets 1/2"

Z-SERIES
HAND
MANUALES

TITANIUM
DE TITANIO

ACCESSORIES
ACCESORIOS

SCREWDRIVERS
DESTORNILLADORES

IMPACT
DE IMPACTO

SLEEVE-DRIVE
MANGUITO

INDUSTRIAL
INDUSTRIALES

PROTECTOR
PROTECTORES

AUTOMOTIVE
AUTOMOTIV

CONSTRUCTION
CONSTRUCCION

RENEWAL KITS
JUEGOS DE PIEZAS REPUESTO

4774N Flexible Ratchet, Reversible
Llave de Carraca Flexible, Reversible



* Renewal Kits → 4753RK → P304



4774P Flexible Ratchet, Reversible
Llave de Carraca Flexible, Reversible



* Renewal Kits → 4753RK → P304



4774J Flexible Ratchet, Reversible
Llave de Carraca Flexible, Reversible



* Renewal Kits → 4753RK → P304

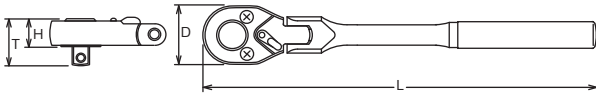

	D (mm)	T (mm)	H (mm)	L (mm)	(g)	(pce.)
4774N	38	36.2	21.6	330	700	1
4774P	38	36.2	21.6	330	700	1
4774J	38	36.2	21.6	330	685	1

4774P-450 Flexible Ratchet, Reversible 
Llave de Carraca Flexible, Reversible



* Renewal Kits → 4753RK → P304

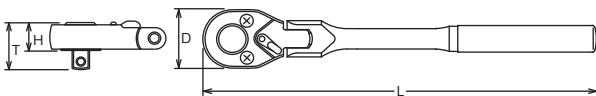

	D (mm)	T (mm)	H (mm)	L (mm)	(g)	(pce.)
4774P-450	38	36.2	21.6	450	790	1

 4774P-450 has longer handle than standard, and can be loaded to excessive torque value. In the interest of your own safety always apply load evenly and progressively to avoid breakage and possible injury.

1/2" Hand Sockets



* Renewal Kits → 4753BRK → P304

4774NB

Flexible Ratchet, Reversible with Quick Release Button
Llave de Carraca Flexible, reversible con botón de extracción rápida



OVAL SHAPE SHANK



* Renewal Kits → 4753BRK → P304

4774PB

Flexible Ratchet, Reversible with Quick Release Button
Llave de Carraca Flexible, reversible con botón de extracción rápida



* Renewal Kits → 4753BRK → P304

4774JB

Flexible Ratchet, Reversible with Quick Release Button
Llave de Carraca Flexible, reversible con botón de extracción rápida



	D (mm)	T (mm)	H (mm)	L (mm)	(g)	(pce.)
4774NB	38	36.2	21.6	330	700	1
4774PB	38	36.2	21.6	330	700	1
4774JB	38	36.2	21.6	330	685	1

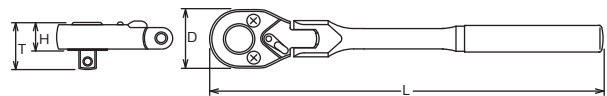

Reversible Ratchet with quick release button has less strength compared with normal ratchet due to the technical design. Make sure to use the ratchet correctly.



Reversible Ratchet with Quick Release Button :

Sockets and accessories are safely locked. By pushing the button the sockets or extension bars are released from the ratchet.

Llave de Carraca Reversible con Botón de Extracción Rápida :

Los vasos y accesorios se bloquean en posición. Los vasos o las alargaderas se extraen de la llave apretando el botón.

Z-SERIES
HAND
MANUALES
TITANIUM
DE TITANIO
ACCESSORIES
ACCESORIOS
SCREWDRIVERS
DESTORNILLADORES
IMPACT
DE IMPACTO
SLEEVE-DRIVE
INDUSTRIAL
INDUSTRIALES
PROTECTOR
PROTECTORES
AUTOMOTIVE
CONSTRUCTION
RENEWAL KITS
JUEGOS DE PIEZAS/REPUESTO

Hand Sockets 1/2"

Z-SERIES
HAND
MANUALES
TITANIUM
DE TITANIO
ACCESSORIES
ACCESORIOS
SCREWDRIVERS
DESTORNILLADORES
IMPACT
DE IMPACTO
SLEEVE-DRIVE
INDUSTRIAL
INDUSTRIALES
PROTECTOR
PROTECTORES
AUTOMOTIVE
CONSTRUCTION
CONSTRUCCIÓN
RENEWAL KITS
JUEGOS DE PIEZAS REPUESTO

4768N-300 Hinge Handle Mango Articulado

* Renewal Kits → 4768RK → P306



RENEWAL KIT FOR
HINGE HANDLE



OVAL SHAPE
SHANK

4768N-380 • -450 Hinge Handle Mango Articulado

* Renewal Kits → 4768RK → P306



4768P-380 • -450 Hinge Handle Mango Articulado

* Renewal Kits → 4768RK → P306



4768J-380 • -450 Hinge Handle Mango Articulado

* Renewal Kits → 4768RK → P306

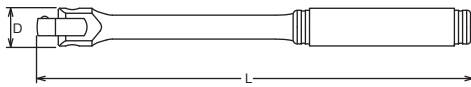

⚠ 4768-450 has longer handle than standard, and can be loaded to excessive torque value. Please use carefully.

	D (mm)	L (mm)	⚖ (g)	📦 (pcs.)
4768N-300	28	300	600	2
4768N-380	28	380	696	2
4768N-450	28	450	784	2
4768P-380	28	380	665	2
4768P-450	28	450	748	2
4768J-380	28	380	600	1
4768J-450	28	450	690	1

4768N-600 Hinge Handle Mango Articulado

* Renewal Kits → 4768RK → P306



4768P-600 Hinge Handle Mango Articulado

* Renewal Kits → 4768RK → P306



4768J-600 Hinge Handle Mango Articulado

* Renewal Kits → 4768RK → P306



⚠ 4768-600 has longer handle than standard, and can be loaded to excessive torque value. In the interest of your own safety always apply load evenly and progressively to avoid breakage and possible injury.

	D (mm)	L (mm)	⚖ (g)	📦 (pcs.)
4768N-600	28	600	1100	1
4768P-600	28	600	1170	1
4768J-600	28	600	1120	1

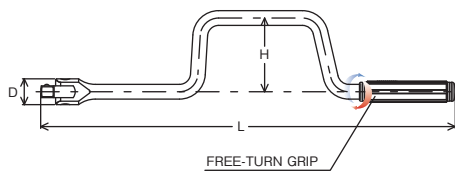

4781N-450 Flexible Speed Handle
Manivela Rápida Flexible



* Renewal Kits → **4768RK** → P306

	D (mm)	H (mm)	L (mm)	(g)	(pcs.)
4781N-450	28	80	450	1000	1

4755 Ratchet Adaptor
Adaptador de carraca

45

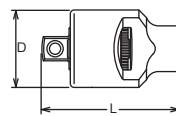

* Renewal Kits → **4755RK** → P306

	D (mm)	L (mm)	(g)	(pcs.)
4755	33.5	65	270	5

4756 Quick Spinner
Disco de Giro Rápido

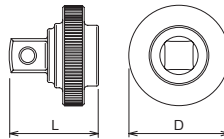

	D (mm)	L (mm)	(g)	(pcs.)
4756	38	34.5	95	10

4770 Universal Joint
Articulación Universal

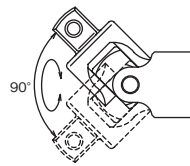
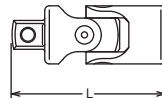

	L (mm)	(g)	(pcs.)
4770	62.4	150	10

4771 Universal Joint
Articulación Universal

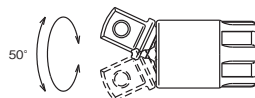
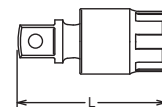

	L (mm)	(g)	(pcs.)
4771	57.7	113	10



Z-SERIES
HAND
MANUALES
TITANIUM
DE TITANIO
ACCESSORIES
ACCESORIOS
SCREWDRIVERS
DESTORNILLADORES
IMPACT
DE IMPACTO
SLEEVE-DRIVE
INDUSTRIAL
INDUSTRIALES
PROTECTOR
PROTECTORES
AUTOMOTIVE
CONSTRUCTION
CONSTRUCCION
RENEWAL KITS
JUEGOS DE PIEZAS/REPUESTO

Hand Sockets 1/2"

Z-SERIES
HAND
MANUALES

TITANIUM
DE TITANIO

ACCESSORIES
ACCESORIOS

SCREWDRIVERS
DESTORNILLADORES

IMPACT
DE IMPACTO

SLEEVE-DRIVE
DE IMPACTO

INDUSTRIAL
INDUSTRIALES

PROTECTOR
PROTECTORES

AUTOMOTIVE

CONSTRUCTION
CONSTRUCCIÓN

RENEWAL KITS
JUEGOS DE PIEZAS REPUESTO

4760 Extension Bars Alargaderas

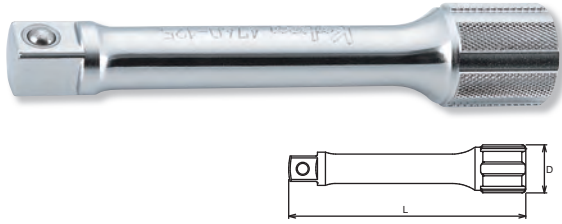

4760	D (mm)	L (mm)	(g)	(pcs.)
50	24	50	92	10
75	24	75	138	10
100	24	100	158	5
125	24	125	194	5
150	24	150	266	5
200	24	200	295	5
250	24	250	358	5
300	24	300	492	2
400	24	400	650	1
500	24	500	808	1
600	24	600	968	1
900	24	900	1430	1
1000	24	1000	1593	1

PK4760/5 Set Juego



PK4760/5	5 Pieces Set/△=1,050g
PLASTIC TRAY	
Extension Bars	
4760 Extension Bars 50, 75, 125, 150, 250	

4763 Wobble-Fix Extension Bars Alargaderas Articuladas-Fijas

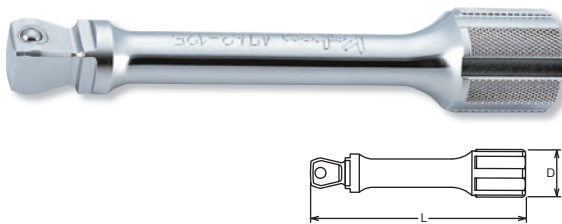

4763	D (mm)	L (mm)	(g)	(pcs.)
50	24	50	95	10
75	24	75	111	10
125	24	125	157	5
150	24	150	181	5
250	24	250	357	5
400	24	400	650	1

⚠ The Wobble-Fix Extension Bar has less strength than normal extension bar due to its specific design with a reduced square drive. Make sure to use it correctly.

PK4763/5 Set Juego



PK4763/5	5 Pieces Set/△=950g
PLASTIC TRAY	
Extension Bars	
4763 Wobble-Fix Extension Bars 50, 75, 125, 150, 250	

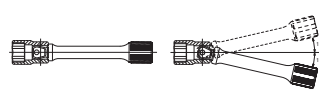

Wobble-Fix Extension Bar
Two way usage : one for as a flexible extension bar to provide at 15° angle operation, the other for use as a normal extension bar. This usage is Patent.

4780-400 Speed Handle Manivela Rápida

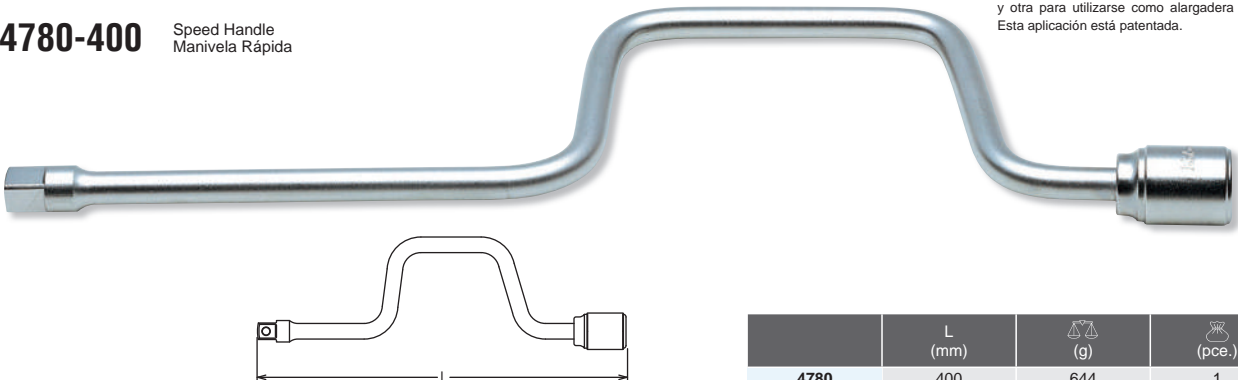

4780	L (mm)	(g)	(pcs.)
4780	400	644	1



4785 T-Handle Mango Corredizo



Innovative Oval shaped bar provides higher durability and stops the sliding square part turning around the bar.



	L (mm)	(g)	(pcs.)
4785	300	410	2

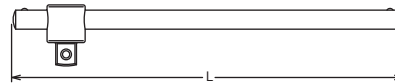

4747 L-Handle Mango Acodado



	L1 (mm)	L2 (mm)	(g)	(pcs.)
4747	260	50	470	1

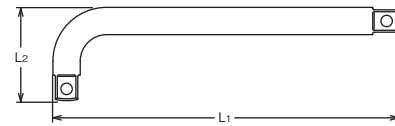

4788-250 • -300 • -450 L-Handles Mango Acodado ⚠



	L1 (mm)	L2 (mm)	(g)	(pcs.)
4788				
250	250	53	417	2
300	300	53	503	1
450	450	53	745	1

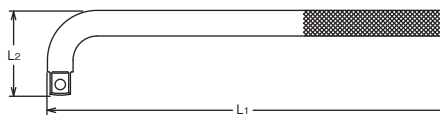

⚠ 4788-450 have longer handle than standard, and can be loaded to excessive torque value. In the interest of your own safety always apply load evenly and progressively to avoid breakage and possible injury.

4433A	(sq.)	(sq.)	L (mm)	(g)	(pcs.)
35	1/2"	3/8"	35	50	10
75	1/2"	3/8"	75	120	10
125	1/2"	3/8"	125	164	5
250	1/2"	3/8"	250	275	5
600	1/2"	3/8"	600	530	1

⚠ Adapting down from bigger square drive to smaller square drive may lead to excessive torque and possibly cause breakage.

La adaptación de mayor a menor de un cuadrado conductor puede conducir a un par excesivo que puede causar roturas.

	(sq.)	(sq.)	L (mm)	(g)	(pcs.)
4466A	1/2"	3/4"	42	108	10

4433A Adaptors Adaptadores Warranty 290Nm Garantia 290Nm ⚠

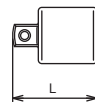

4466A Adaptor Adaptador

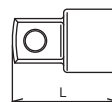

Z-SERIES
HAND MANUALES
TITANIUM DE TITANIO
ACCESSORIES ACCESORIOS
SCREWDRIVERS DESTORNILLADORES
IMPACT DE IMPACTO
SLEEVE-DRIVE INDUSTRIAL INDUSTRIALES
PROTECTOR PROTECTORES
AUTOMOTIVE
CONSTRUCTION CONSTRUCCION
RENEWAL KITS JUEGOS DE HERRAMIENTAS

Hand Sockets 1/2"

Z-SERIES
HAND
MANUALES

TITANIUM
DE TITANIO

ACCESSORIES
ACCESORIOS

SCREWDRIVERS
DESTORNILLADORES

IMPACT
DE IMPACTO

SLEEVE-DRIVE

INDUSTRIAL
INDUSTRIALES

PROTECTOR
PROTECTORES

AUTOMOTIVE

RENEWAL KITS
JUEGOS DE PIEZAS/REPUSTO
CONSTRUCCION

4222M Socket Set Juego de Vasos



4223M Socket Set Juego de Vasos



4227M Bit Socket Set Juego de Vasos con Punta



4230M • 4230A Socket Sets Juegos de Vasos





4232M Socket Set Juego de Vasos





4222M 13 Pieces Set/△=2,780g

METAL CASE:W415xH120xT50mm

Sockets	Accessories
4405M 12-pt. Sockets 10, 11, 12, 13, 14, 17, 19, 21, 22, 24	 4753N  4760-125  4770

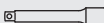

4223M 15 Pieces Set/△=2,600g

METAL CASE:W415xH120xT50mm

Sockets	Accessories
4405M 12-pt. Sockets 10, 11, 12, 13, 14, 15, 16, 17, 18, 19, 21, 22	 4753N  4760-125  4770

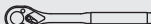

4227M 10 Pieces Set/△=2,550g

METAL CASE:W310xH150xT50mm

Sockets	Accessories
4012M.75 Hex Bit Sockets 5, 6, 8, 10, 12, 14, 17	 4749N-250  4760-75  4760-125

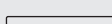

4230M 17 Pieces Set/△=3,150g

METAL CASE:W395xH90xT50mm

Sockets	Accessories
4405M 12-pt. Sockets 9, 10, 12, 13, 14, 15, 16, 17, 18, 19, 21, 23, 26	 4753N  4760-125 4768N-380  4710



4230A 17 Pieces Set/△=3,150g

METAL CASE:W395xH90xT50mm

Sockets	Accessories
4405A 12-pt. Sockets 3/8, 7/16, 1/2, 9/16, 19/32, 5/8, 11/16, 3/4, 25/32, 13/16, 7/8, 15/16, 1	 4753N  4760-125 4768N-380  4710

4232M 16 Pieces Set/△=3,300g

METAL CASE:W415xH120xT50mm

Sockets	Accessories
4405M 12-pt. Sockets 8, 9, 10, 12, 13, 14, 17, 19, 21, 22, 23, 24, 26	 4753N  4760-125 4768N-380

1/2" Hand Sockets

4240M-00	4400M	32 Pieces Set/△=4,400g
4240M-05	4405M	32 Pieces Set/△=4,400g

DISPLAY STAND:W410xH160xT500mm

Sockets

Sockets (2pcs.each)

10, 11, 12, 13, 14, 15, 16, 17, 19, 21, 22, 23, 24, 27, 30, 32

4240A-00	4400A	32 Pieces Set/△=4,700g
4240A-05	4405A	32 Pieces Set/△=4,700g

DISPLAY STAND:W410xH160xT500mm

Sockets

Sockets (2pcs.each)

3/8, 7/16, 1/2, 9/16, 19/32, 5/8, 11/16, 3/4, 13/16, 7/8, 15/16, 1, 1.1/16, 1.1/8, 1.3/16, 1.1/4

4240M-00 · 4240A-00 ○ Display Stands Expositores
4240M-05 · 4240A-05 ○



S4240M-00	4400M	117 Pieces Set/△=13,000g
S4240M-05	4405M	117 Pieces Set/△=13,000g

DISPLAY STAND:W510xH150xT230mm

Sockets

10mm:9pcs	16mm:9pcs	24mm:6pcs
11mm:9pcs	17mm:8pcs	27mm:5pcs
12mm:9pcs	19mm:7pcs	30mm:5pcs
13mm:9pcs	21mm:7pcs	32mm:4pcs
14mm:9pcs	22mm:6pcs	
15mm:9pcs	23mm:6pcs	

S4240A-00	4400A	103 Pieces Set/△=13,000g
S4240A-05	4405A	103 Pieces Set/△=13,000g

DISPLAY STAND:W510xH150xT230mm

Sockets

3/8" :9pcs	11/16":8pcs	1" :5pcs
7/16":9pcs	3/4" :7pcs	1.1/16":5pcs
1/2" :9pcs	13/16":7pcs	1.1/8" :5pcs
9/16":9pcs	7/8" :6pcs	1.3/16":5pcs
5/8" :9pcs	15/16":6pcs	1.1/4" :4pcs

S4240M-00 · S4240A-00 ○ Display Stands Expositores
S4240M-05 · S4240A-05 ○



Z-SERIES
 HAND
 MANUALES
 TITANIUM
 DE TITANIO
 ACCESSORIES
 ACCESORIOS
 SCREWDRIVERS
 DESTORNILLADORES
 IMPACT
 DE IMPACTO
 SLEEVE-DRIVE
 INDUSTRIAL
 INDUSTRIALES
 PROTECTOR
 PROTECTORES
 AUTOMOTIVE
 CONSTRUCTION
 CONSTRUCCION
 RENEWAL KITS
 JUEGOS DE REPARACION

Hand Sockets 1/2"

Z-SERIES

HAND
MANUALESTITANIUM
DE TITANIOACCESSORIES
ACCESORIOSSCREWDRIVERS
DESTORNILLADORESIMPACT
DE IMPACTOSLEEVE-DRIVE
INDUSTRIALINDUSTRIAL
INDUSTRIALESPROTECTOR
PROTECTORES

AUTOMOTIVE





CONSTRUCTION
CONSTRUCCIÓNRENEWAL KITS
JUEGOS DE PIEZAS REPUES

4238AM Socket Set Juego de Vasos

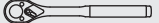
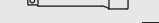

4238AM 38 Pieces Set/⚖️=8,050g

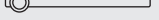
METAL CASE:W446xH266xT50mm





Sockets	Accessories
4405M 12-pt. Sockets 10, 11, 12, 13, 14, 15, 16, 17, 18, 19, 21, 22, 23, 24, 26, 27, 30, 32	 4753N  4760-125  4760-250  4770  4780  4785
4405A 12-pt. Sockets 3/8, 7/16, 1/2, 9/16, 5/8, 11/16, 3/4, 13/16, 7/8, 15/16, 1.1/16, 1.1/8, 1.1/4	
4300C Spark Plug Socket 20.8	

4241M Socket Set Juego de Vasos

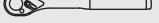
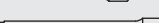

4241M 28 Pieces Set/⚖️=6,500g

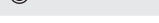
METAL CASE:W445xH190xT50mm







Sockets	Accessories
4405M 12-pt. Sockets 10, 11, 12, 13, 14, 15, 16, 17, 18, 19, 20, 21, 22, 23, 24, 25, 26, 27, 28, 29, 30, 32	 4753N  4760-125  4760-250  4768N-380  4770  4785

4241A Socket Set Juego de Vasos

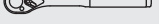

4241A 19 Pieces Set/⚖️=5,350g

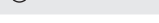
METAL CASE:W445xH190xT50mm



Sockets	Accessories
4405A 12-pt. Sockets 3/8, 7/16, 1/2, 9/16, 5/8, 11/16, 3/4, 13/16, 7/8, 15/16, 1.1/16, 1.1/8, 1.1/4	 4753N  4760-125  4760-250  4768N-380  4770  4785

4244M • 4244A Socket Sets Juegos de Vasos





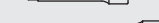

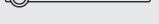
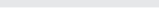
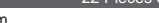

4244M 22 Pieces Set/⚖️=5,500g

METAL CASE:W445xH190xT50mm

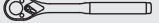
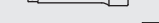
Sockets	Accessories
4405M 12-pt. Sockets 9, 10, 12, 13, 14, 15, 16, 17, 18, 19, 21, 23, 26, 29, 32	 4753N  4760-125  4760-250  4768N-380  4770  4785  4710

4244A 22 Pieces Set/⚖️=5,650g

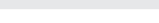
METAL CASE:W445xH190xT50mm

Sockets	Accessories
4405A 12-pt. Sockets 3/8, 7/16, 1/2, 9/16, 19/32, 5/8, 11/16, 3/4, 25/32, 13/16, 7/8, 15/16, 1, 1.1/8, 1.1/4	 4753N  4760-125  4760-250  4768N-380  4770  4785  4710

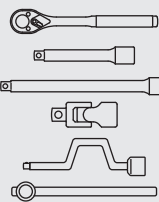
4248M 24 Pieces Set/△=5,700g	
METAL CASE:W445xH190xT50mm	
Sockets	Accessories
4405M 12-pt. Sockets 10, 11, 12, 13, 14, 15, 16, 17, 18, 19, 21, 22, 23, 24, 26, 27, 30, 32	 4753N 4760-125 4760-250 4770 4780 4785

4248M Socket Set
Juego de Vasos

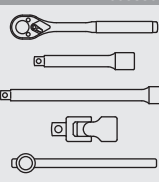

4250M 18 Pieces Set/△=3,700g	
METAL CASE:W445xH190xT50mm	
Sockets	Accessories
4405M 12-pt. Sockets 10, 11, 12, 13, 14, 15, 17, 19, 22, 24, 27, 30, 32	 4753N 4760-125 4760-250 4770 4785

4250M Socket Set
Juego de Vasos



4251M 22 Pieces Set/△=3,200g	
METAL CASE:W330xH68xT48mm	
Sockets	
4405M 12-pt. Sockets 10, 11, 12, 13, 14, 15, 16, 17, 18, 19, 20, 21, 22, 23, 24, 25, 26, 27, 28, 29, 30, 32	

4251M · 4251A Socket Sets
Juegos de Vasos



4251A 18 Pieces Set/△=2,660g	
METAL CASE:W330xH68xT48mm	
Sockets	
4405A 12-pt. Sockets 3/8, 7/16, 1/2, 9/16, 5/8, 19/32, 21/32, 11/16, 3/4, 25/32, 13/16, 7/8, 15/16, 1, 1.1/16, 1.1/8, 1.3/16, 1.1/4	

4252M 13 Pieces Set/△=1,200g	
METAL CASE:W168xH60xT42mm	
Sockets	
4405M 12-pt. Sockets 10, 11, 12, 13, 14, 15, 16, 17, 18, 19, 20, 21, 22	

4252M · 4252A Socket Sets
Juegos de Vasos



4252A 13 Pieces Set/△=1,300g	
METAL CASE:W168xH60xT42mm	
Sockets	
4405A 12-pt. Sockets 3/8, 7/16, 1/2, 9/16, 19/32, 5/8, 21/32, 11/16, 3/4, 25/32, 13/16, 7/8, 15/16	

4254 12 Pieces Set/△=1,070g	
METAL CASE:W215xH80xT47mm	
Sockets	Accessories
3425- E6, E8 4425- E10, E12, E14 3325- E6, E8 4325- E10, E12, E14	 4763-50 4433A-35

4254 Socket Set
Juego de Vasos



Hand Sockets 1/2"

Z-SERIES

HAND
MANUALES

TITANIUM
DE TITANIO

ACCESSORIES
ACCESORIOS

SCREWDRIVERS
DESTORNILLADORES

IMPACT
DE IMPACTO

SLEEVE-DRIVE
INDUSTRIALES

INDUSTRIAL
INDUSTRIALES

PROTECTOR
PROTECTORES

AUTOMOTIVE

CONSTRUCTION
CONSTRUCCIÓN

RENEWAL KITS
JUEGOS DE PIEZAS REPUESTO

4261M Socket Set Juego de Vasos



4261M 18 Pieces Set/⚖️=4,870g	
METAL CASE:W445xH190xT50mm	
Sockets	Accessories
4405M 12-pt. Sockets 8, 10, 11, 12, 13, 14, 17, 19, 21, 22, 24, 26, 27	4753N 4760-125 4760-250 4768N-380 4770

4263M Socket Set Juego de Vasos



4263M 21 Pieces Set/⚖️=6,100g	
METAL CASE:W445xH190xT50mm	
Sockets	Accessories
4405M 12-pt. Sockets 8, 10, 11, 12, 13, 14, 15, 17, 19, 21, 22, 23, 24, 26, 27	4753N 4760-125 4760-250 4768N-380 4770 4715S

4273AM Socket Set Juego de Vasos



4273AM 30 Pieces Set/⚖️=6,940g	
METAL CASE:W446xH266xT50mm	
Sockets	Accessories
4405M 12-pt. Sockets 10, 11, 12, 13, 14, 17, 19, 21, 22, 23, 24, 26, 27	4753N 4760-125 4760-250 4768N-380 4770 4785
4405A 12-pt. Sockets 3/8, 7/16, 1/2, 9/16, 5/8, 11/16, 3/4, 13/16, 7/8, 15/16, 1	

P4241M-00 Socket Sets Juegos de Vasos

P4241M-05



P4241M-00 28 Pieces Set/⚖️=6,400g	
PLASTIC CASE:W425xH332xT65mm	
Sockets	Accessories
4400M 6-pt. Sockets 10, 11, 12, 13, 14, 15, 16, 17, 18, 19, 20, 21, 22, 23, 24, 25, 26, 27, 28, 29, 30, 32	4753J 4760-125 4760-250 4768J-380 4770 4785

P4241M-05 28 Pieces Set/⚖️=6,400g	
PLASTIC CASE:W425xH332xT65mm	
Sockets	Accessories
4405M 12-pt. Sockets 10, 11, 12, 13, 14, 15, 16, 17, 18, 19, 20, 21, 22, 23, 24, 25, 26, 27, 28, 29, 30, 32	4753J 4760-125 4760-250 4768J-380 4770 4785

1/2" Hand Sockets

Z-SERIES
HAND
MANUALES
TITANIUM
DE TITANIO
ACCESSORIES
ACCESORIOS
SCREWDRIVERS
DESTORNILLADORES
IMPACT
DE IMPACTO
SLEEVE-DRIVE
INDUSTRIAL
INDUSTRIALES
PROTECTOR
PROTECTORES
AUTOMOTIVE
CONSTRUCTION
CONSTRUCCION
RENEWAL KITS
JUEGOS DE PIEZAS/REPUESTO

4275		24 Pieces Set/△=5,340g	
METAL CASE:W445xH190xT50mm			
Sockets	Accessories		
4400M 6-pt. Sockets 10, 11, 12, 13, 14, 15, 16, 17, 18, 19, 21, 22, 24			4750N
4300C Spark Plug Sockets 16, 20.8			4760-125
4300M Wheel Nut Sockets 17(L60), 19(L60), 21(L60)			4760-250
			4768N-380
			4770
			4785

4275 Socket Set
Juego de Vasos



4276		17 Pieces Set/△=2,890g	
METAL CASE:W370xH150xT50mm			
Sockets	Accessories		
4010M.50 Bit Sockets 6, 7, 8, 10, 12, 14			4752N
4025.60 TORX® Bit Sockets T20, T25, T27, T30, T40, T45, T50, T55, T60			4763-125

4276 Socket Set
Juego de Vasos



4277		27 Pieces Set/△=5,660g	
METAL CASE:W445xH190xT50mm			
Sockets	Accessories		
4405M 12-pt. Sockets 10, 12, 13, 14, 15, 16, 17, 18, 19, 21, 22, 24			4750N
4305M 12-pt. Deep Sockets 10, 12, 13, 14, 15, 16, 17, 18, 19, 21, 22, 24			4760-125
			4768N-380

4277 Socket Set
Juego de Vasos



4279AM		36 Pieces Set/△=6,000g	
METAL CASE:W445xH190xT50mm			
Sockets	Accessories		
4405M 12-pt. Sockets 10, 11, 12, 13, 14, 15, 16, 17, 18, 19, 21, 22, 23, 24, 26, 27, 30, 32			4753N
4405A 12-pt. Sockets 3/8, 7/16, 1/2, 9/16, 5/8, 11/16, 3/4, 13/16, 7/8, 15/16, 1.1/16, 1.1/8, 1.1/4			4760-125
			4760-250
			4770
			4785

4279AM Socket Set
Juego de Vasos



4289M		18 Pieces Set/△=4,200g	
METAL CASE:W445xH190xT50mm			
Sockets	Accessories		
4405M 12-pt. Sockets 8, 10, 12, 13, 14, 17, 19, 21, 22, 24, 27, 30, 32			4753N
			4760-125
			4760-250
			4768N-450
			4771

4289M Socket Set
Juego de Vasos



Hand Sockets 3/4"

Z-SERIES
HAND
MANUALES
TITANIUM
DE TITANIO
ACCESSORIES
ACCESORIOS
SCREWDRIVERS
DESTORNILLADORES
IMPACT
DE IMPACTO
SLEEVE-DRIVE
INDUSTRIAL
INDUSTRIALES
PROTECTOR
PROTECTORES
AUTOMOTIVE
CONSTRUCTION
CONSTRUCCIÓN
RENEWAL KITS
JUEGOS DE PIEZAS/REPUÉSTO

6400M • 6400A

6-point Sockets
Vasos Hexagonales

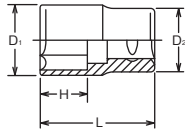

6400M 6405M (mm)	D ₁ (mm)	D ₂ (mm)	H (mm)	L (mm)	(g)	(pcs.)
14	22.1	34	11	50	160	10
16	24.6	34	12	50	167	10
17	26	34	12.5	50	175	5
18	27	34	13	50	178	5
19	28.5	34	13.5	50	179	5
20	29.5	34	14	50	185	5
21	31	34	14.5	50	185	5
22	32	34	15	50	187	5
23	33.5	34	16	50	187	5
24	34.5	34	17	50	200	5
25	36	34	17.5	50	217	5
26	37	34	18	50	222	5
27	38.5	37	19	53	254	5
28	39.5	38	19.5	53	298	5
29	41	38	20	55	292	5
30	42	38	21	55	301	5
31	43.5	38	22	57	294	5
32	44.5	40	23	57	351	5
33	46	40	23.5	57	384	5
34	47	40	24	57	397	5
35	48.5	42	24.5	59	422	5
36	49.5	42	25	59	438	5
37	51	42	25.5	59	484	5
38	52	45	26	59	523	5
39	53.5	45	26.5	59	538	5
40	54.5	45	27	62	550	5
41	56	47	28	62	633	5
42	57	47	28.5	62	652	2
43	58.5	47	29	62	659	2
44	59.5	47	29.5	62	657	2
45	61	47	30	68	734	2
46	62	47	31	68	791	2
47	63.5	48	31.5	68	816	2
48	64.5	45	32	68	800	2
50	67	48	34	68	880	2
52	69.5	53	33	72	925	2
54	72	55	33	72	1040	2
55	73.5	53	36	72	1006	2
56	74.5	53	36	72	1092	2
57	76	53	36	72	1169	2
58	77	53	36	72	1149	2
60	79.5	58	39	76	1402	2
63	83.5	58	39	76	1494	2
65	86	63	42	80	1608	2
70	92	68	45	84	1785	2
75	98.5	73	48	86	2186	1
78	102.1	73	55	86	2425	1
80	104.5	78	52	90	2475	1
85	111	78	52	90	2620	1

6405M • 6405A

12-point Sockets
Vasos Bihexagonales

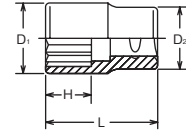

6400A 6405A (inch)	D ₁ (mm)	D ₂ (mm)	H (mm)	L (mm)	(g)	(pcs.)
5/8	24.6	34	12	50	168	10
11/16	27	34	13	50	178	5
3/4	28.5	34	13.5	50	179	5
25/32	29.5	34	14	50	185	5
13/16	31	34	14.5	50	185	5
7/8	32	34	15	50	187	5
15/16	34.5	34	17	50	200	5
31/32	36	34	17.5	50	217	5
1	37	34	18	50	222	5
1. 1/16	38.5	37	19	53	254	5
1. 1/8	41	38	20	53	292	5
1. 3/16	42	38	21	55	301	5
1. 1/4	44.5	40	23	57	351	5
1. 5/16	46	40	23.5	57	384	5
1. 3/8	48.5	42	24.5	57	422	5
1. 7/16	51	42	25.5	59	484	5
1. 1/2	52	45	26	59	523	5
1. 9/16	54.5	45	27	59	550	5
1. 5/8	56	47	28	62	633	5
1.11/16	58.5	47	29	62	659	2
1. 3/4	59.5	47	29.5	62	657	2
1.13/16	62	47	31	68	791	2
1. 7/8	64.5	45	32	68	892	2
1.15/16	66	48	32.5	68	870	2
2	68.5	52	34.5	68	949	2
2. 1/16	71	54	33	72	983	2
2. 1/8	72	55	33	72	1040	2
2. 3/16	74.5	53	36	72	1092	2
2. 1/4	76	53	36	72	1169	2
2. 5/16	78.5	53	36	72	1344	2
2. 3/8	79.5	58	39	76	1402	2
2. 7/16	82	58	39	76	1420	2
2. 1/2	84.5	58	39	76	1497	2
2. 9/16	86	63	42	80	1608	2
2. 5/8	88.5	63	42	80	1709	2
2.11/16	89.5	63	42	80	1634	2
2. 3/4	92	68	45	84	1785	2
2.13/16	94.5	68	45	84	2018	2
2. 7/8	96	68	45	84	2062	2
2.15/16	98.5	73	48	86	2186	1
3	101	73	48	86	2309	1
3. 1/8	104.5	78	52	90	2475	1

6425

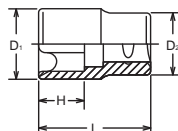

TORX® Sockets
Vasos TORX®



6425 (E)	D ₁ (mm)	D ₂ (mm)	H (mm)	L (mm)	(g)	(pcs.)
E18	22.1	34	11.9	50	156	5
E20	24.6	34	13.3	50	166	5
E22	27.1	34	14.4	50	178	5
E24	28.6	34	16	50	185	5
E26	31.1	34	17.7	55	217	5
E28	32.1	34	24.1	60	237	5
E30	35	34	24.1	60	242	5
E32	36.1	34	24.1	60	247	5

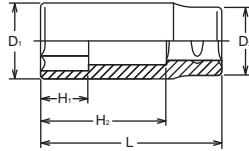

6300M • 6300A 6-point Deep Sockets Vasos Hexagonales Largos



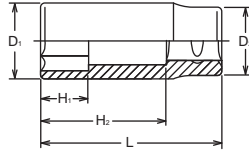

6300M 6305M (mm)	D ₁ (mm)	D ₂ (mm)	H ₁ (mm)	H ₂ (mm)	L (mm)	 (g)	 (pcs.)
17	26	34	18	64	90	278	5
18	27	34	19	64	90	281	5
19	28.5	34	20	64	90	292	5
20	29.5	34	21	64	90	334	5
21	31	34	22	64	90	343	5
22	32	34	23	64	90	347	5
23	33.5	34	24	64	90	361	5
24	34.5	34	25	64	90	352	5
25	36	34	26	64	90	369	5
26	37	34	27	64	90	384	5
27	38.5	37	28	64	90	425	5
28	39.5	38	29	63	90	470	5
29	41	38	30	63	90	503	5
30	42	38	31	63	90	503	5
31	43.5	38	32	62	90	517	5
32	44.5	40	34	62	90	544	5
33	46	40	34	62	90	557	5
34	47	40	35	61	90	570	5
35	48.5	42	36	61	90	622	5
36	49.5	42	37	61	90	631	2
38	52	45	39	60	90	710	2
40	54.5	45	41	60	90	742	2
41	56	47	42	59	90	802	2
42	57	47	43	59	90	829	2
44	59.5	47	45	59	90	838	2
46	62	47	47	58	90	906	2
48	64.5	50	49	57	90	998	2
50	67	48	51	57	90	1005	2
52	69.5	53	49	-	100	1270	2
53	71	54	49	-	100	1338	2
54	72	55	49	-	100	1351	2
55	73.5	53	52	-	100	1388	2
56	74.5	53	52	-	100	1389	2
57	76	53	52	-	100	1467	2
58	77	53	52	-	100	1480	2
60	79.5	58	55	-	100	1626	2
63	83.5	58	55	-	100	1740	2
65	86	63	65	-	100	1939	2

6305M • 6305A 12-point Deep Sockets Vasos Bihexagonales Largos



6300A 6305A (inch)	D ₁ (mm)	D ₂ (mm)	H ₁ (mm)	H ₂ (mm)	L (mm)	 (g)	 (pcs.)
3/4	28.5	34	20	64	90	292	5
25/32	29.5	34	21	64	90	334	5
13/16	31	34	22	64	90	343	5
7/8	32	34	23	64	90	347	5
15/16	34.5	34	25	64	90	352	5
1	37	34	27	64	90	384	5
1. 1/16	38.5	37	28	64	90	425	5
1. 1/8	41	38	30	63	90	503	5
1. 3/16	42	38	31	63	90	503	5
1. 1/4	44.5	40	34	62	90	544	5
1. 5/16	46	40	34	62	90	557	5
1. 3/8	48.5	42	36	61	90	622	5
1. 7/16	51	42	38	61	90	656	2
1. 1/2	52	45	39	60	90	710	2
1. 9/16	54.5	45	41	60	90	742	2
1. 5/8	56	47	42	59	90	802	2
1.11/16	58.5	47	44	59	90	831	2
1. 3/4	59.5	47	45	59	90	838	2
1.13/16	62	47	47	58	90	906	2
2	68.5	52	52	57	90	1061	2
2. 1/16	71	54	49	-	100	1338	2
2. 1/8	72	55	49	-	100	1351	2
2. 3/16	74.5	53	52	-	100	1389	2
2. 1/4	76	53	52	-	100	1467	2
2. 5/16	78.5	53	52	-	100	1787	2
2. 3/8	79.5	58	55	-	100	1626	2
2. 7/16	82	58	55	-	100	1715	2

6012M.75 (mm)	D (mm)	H ₁ (mm)	H ₂ (mm)	L (mm)	 (g)	 (pcs.)
12	35	15.5	40	75	253	10
14	35	15.5	40	75	265	10
15	35	15.5	40	75	271	10
16	35	15.5	40	75	285	10
17	35	15.5	40	75	292	10
18	35	15.5	40	75	302	10
19	35	15.5	40	75	312	10
20	35	15.5	40	75	323	10
21	38	15.5	40	75	330	10
22	38	22.5	40	75	340	10
24	38	22.5	40	75	362	10
27	38	22.5	40	75	402	10
30	38	28.5	40	75	445	10
32	38	28.5	40	75	485	10
36	42	28.5	40	75	663	10

6012M-75 Inhex Sockets Vasos con Punta Hexagonal

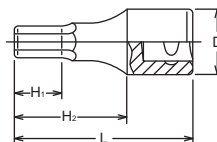

Z-SERIES
HAND
MANUALES
TITANIUM
DE TITANIO
ACCESSORIES
ACCESORIOS
SCREWDRIVERS
DESTORNILLADORES
IMPACT
DE IMPACTO
SLEEVE-DRIVE
INDUSTRIAL
INDUSTRIALES
PROTECTOR
PROTECTORES
AUTOMOTIVE
CONSTRUCTION
CONSTRUCCION
RENEWAL KITS
JUEGOS DE PIEZAS/REPLUSTO

Hand Sockets **3/4"**

Z-SERIES
HAND
MANUALES
TITANIUM
DE TITANIO
ACCESSORIES
ACCESORIOS
SCREWDRIVERS
DESTORNILLADORES
IMPACT
DE IMPACTO
SLEEVE-DRIVE
INDUSTRIAL
INDUSTRIALES
PROTECTOR
PROTECTORES
AUTOMOTIVE
CONSTRUCTION
CONSTRUCCIÓN
RENEWAL KITS
JUEGOS DE PIEZAS REPUESTO

6749 6749-1000 ⚠ 6749-HEAD PIPE-400 · -800

Reversible Ratchet
Llave de Carraca Reversible



* Renewal Kits → 6749RK → P304

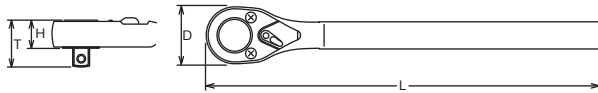

	D (mm)	T (mm)	H (mm)	L (mm)	Weight (g)	Qty (pce.)
6749	68	49.6	29.6	565	2840	1
6749-1000	68	49.6	29.6	965	3960	1
New 6749-HEAD	68	49.6	29.6	165	1730	1
New PIPE-400	-	-	-	400	1110	1
New PIPE-800	-	-	-	800	2230	1



⚠ 6749-1000 have longer handle than standard, and can be loaded to excessive torque value. In the interest of your own safety always apply load evenly and progressively to avoid breakage and possible injury.



6752 6752-HEAD PIPE-400

Reversible Ratchet
Llave de Carraca Reversible



* Renewal Kits → 6752RK → P305

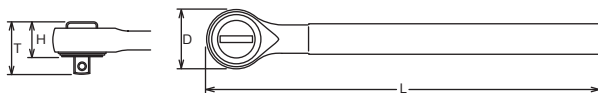

	D (mm)	T (mm)	H (mm)	L (mm)	Weight (g)	Qty (pce.)
6752	67	55.5	35.5	500	2360	1
New 6752-HEAD	67	55.5	35.5	100	1250	1
New PIPE-400	-	-	-	400	1110	1

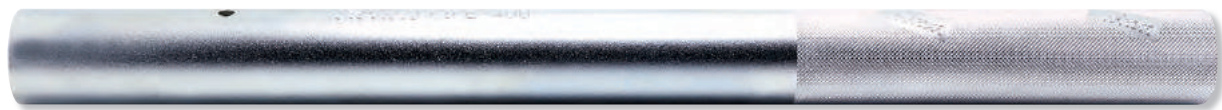

6755 Ratchet Adaptor
Adaptador de carraca

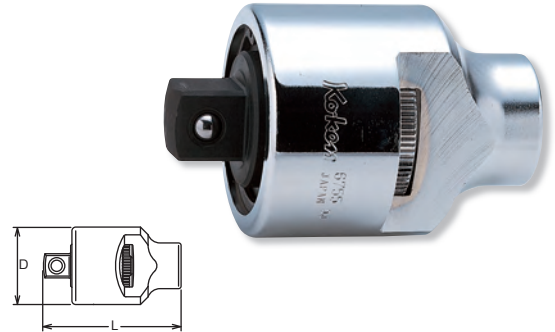

60

* Renewal Kits → 6755RK → P306

	D (mm)	L (mm)	(g)	(pcs.)
6755	62	97	1162	1

6760 Extension Bars
Alargaderas



6760	D (mm)	L (mm)	(g)	(pcs.)
75	35	75	335	10
100	35	100	434	10
125	35	125	528	10
150	35	150	624	2
200	35	200	815	1
300	35	300	1203	1
400	35	400	1585	1



Hand Sockets 3/4"

Z-SERIES
HAND MANUALES
TITANIUM DE TITANIO
ACCESSORIES ACCESORIOS
SCREWDRIVERS DESTORNILLADORES
IMPACT DE IMPACTO
SLEEVE-DRIVE
INDUSTRIAL INDUSTRIALES
PROTECTOR PROTECTORES
AUTOMOTIVE
CONSTRUCTION CONSTRUCCION
RENEWAL KITS JUEGOS DE PIEZAS REPUESTO

6768 Hinge Handle
Mango Articulado

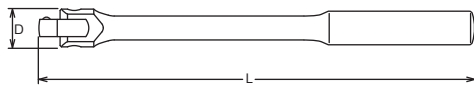

* Renewal Kits → **6768RK** → P306

	D (mm)	L (mm)	(g)	(pce.)
6768	42	450	1780	1

6768-600 · -1000 Hinge Handles
Mangos Articulados ⚠
6768-HEAD
PIPE-400 · -800

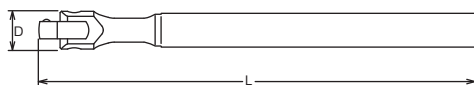

* Renewal Kits → **6768RK** → P306

	D (mm)	L (mm)	(g)	(pce.)
6768				
600	42	600	2900	1
1000	42	1000	3500	1
6768-HEAD	42	200	1250	1
PIPE-400	-	400	1110	1
PIPE-800	-	800	2230	1

⚠ 6768-600/-1000 have longer handle than standard, and can be loaded to excessive torque value. In the interest of your own safety always apply load evenly and progressively to avoid breakage and possible injury.

6785 T-Handle
Mango Corredizo



OVAL SHAPE SHANK

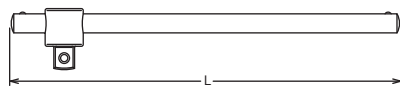
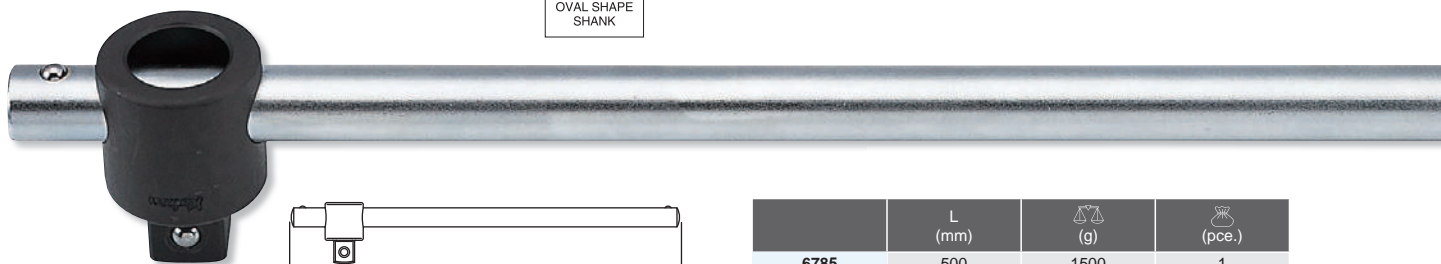

	L (mm)	(g)	(pce.)
6785	500	1500	1

6788 L-Handle
Mango Acodado

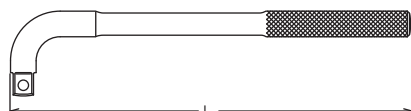
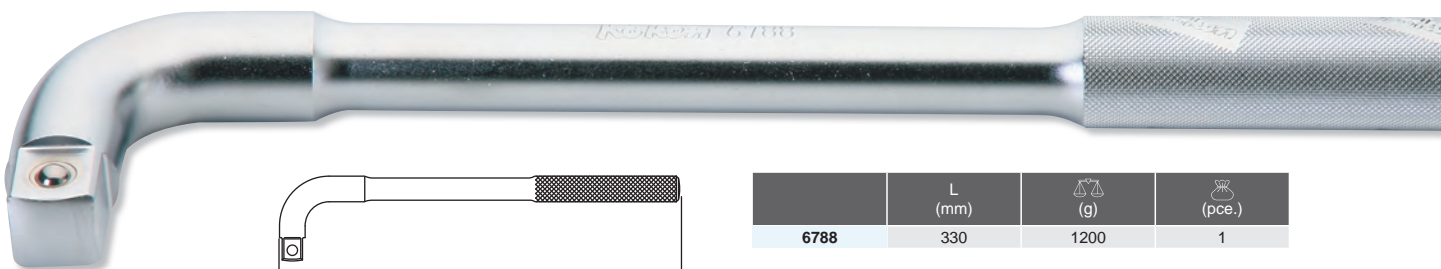

	L (mm)	(g)	(pce.)
6788	330	1200	1

6770 Universal Joint
Articulación Universal

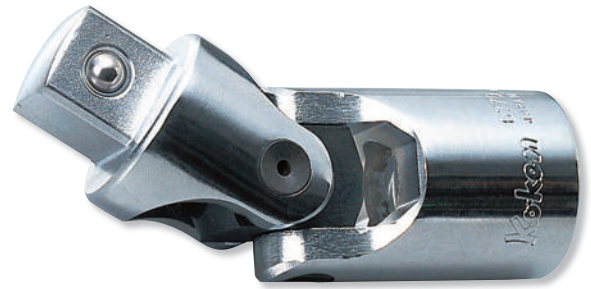

	L (mm)	(g)	(pcs.)
6770	105	500	2

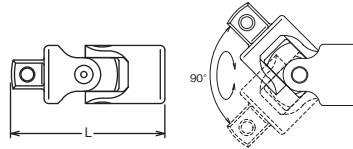

6644A Adaptor Warranty 668Nm
Adaptador Garantía 668Nm ⚠

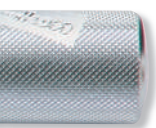
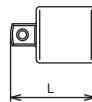

6688A Adaptor
Adaptador

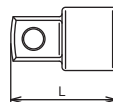

	(sq.)	(sq.)	L (mm)	(g)	(pcs.)
6644A	3/4"	1/2"	47	136	5
6688A	3/4"	1"	60	285	5

⚠ Adapting down from bigger square drive to smaller square drive may lead to excessive torque and possibly cause breakage.

La adaptación de mayor a menor de un cuadrado conductor puede conducir a un par excesivo que puede causar roturas.

Z-SERIES
HAND
MANUALES
TITANIUM
DE TITANIO
ACCESSORIES
ACCESORIOS
SCREWDRIVERS
DESTORNILLADORES
IMPACT
DE IMPACTO
SLEEVE-DRIVE
INDUSTRIAL
INDUSTRIALES
PROTECTOR
PROTECTORES
AUTOMOTIVE
CONSTRUCTION
CONSTRUCCION
RENEWAL KITS
JUEGOS DE PIEZAS/REPLUSTO

Hand Sockets 3/4"

Z-SERIES
HAND
MANUALES

TITANIUM
DE TITANIO

ACCESSORIES
ACCESORIOS

SCREWDRIVERS
DESTORNILLADORES

IMPACT
DE IMPACTO

SLEEVE-DRIVE

INDUSTRIAL
INDUSTRIALES

PROTECTOR
PROTECTORES



AUTOMOTIVE

CONSTRUCTION
CONSTRUCCIÓN

RENEWAL KITS
JUEGOS DE PIEZAS/REPUSTO

6201M • 6201A Socket Sets Juegos de Vasos

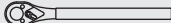
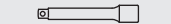
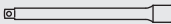

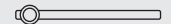

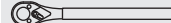
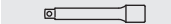
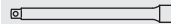
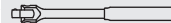
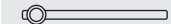
6201M		16 Pieces Set/△=17,300g	
METAL CASE:W580xH200xT85mm			
Sockets		Accessories	
	6405M 12-pt. Sockets 22, 24, 27, 30, 32, 36, 41, 46, 50, 55, 60		6749
			6760-200
			6760-400
			6768
			6785

6201A		18 Pieces Set/△=17,600g	
METAL CASE:W580xH200xT85mm			
Sockets		Accessories	
	6405A 12-pt. Sockets 7/8, 15/16, 1.1/16, 1.1/8, 1.1/4, 1.5/16, 1.7/16, 1.1/2, 1.5/8, 1.11/16, 1.13/16, 1.7/8, 2		6749
			6760-200
			6760-400
			6768
			6785

6212M • 6212A Socket Sets Juegos de Vasos

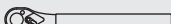
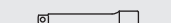
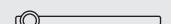



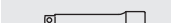
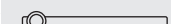



6212M		12 Pieces Set/△=11,000g	
METAL CASE:W580xH124xT70mm			
Sockets		Accessories	
	6405M 12-pt. Sockets 22, 24, 27, 30, 32, 36, 41, 46, 50		6749
			6760-200
			6785



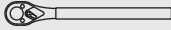



6212A		12 Pieces Set/△=11,000g	
METAL CASE:W580xH124xT70mm			
Sockets		Accessories	
	6405A 12-pt. Sockets 7/8, 15/16, 1.1/16, 1.3/16, 1.1/4, 1.7/16, 1.5/8, 1.13/16, 2		6749
			6760-200
			6785

Sockets in sets can be supplied in 6-pt. or 12-pt. format.

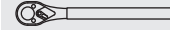
6260M • 6260A Socket Sets Juegos de Vasos





6260M		20 Pieces Set/△=15,800g	
METAL CASE:W580×H200×T85mm			
Sockets		Accessories	
 6405M 12-pt. Sockets 21, 23, 26, 29, 31, 32, 34, 35, 36, 38, 41, 46, 50		6749	
		6760-75	
 6101 Drag Link Socket		6760-200	
		6760-400	
		6770	
		6785	

6260A		25 Pieces Set/△=19,000g	
METAL CASE:W580×H200×T85mm			
Sockets		Accessories	
 6405A 12-pt. Sockets 15/16, 31/32, 1, 1.1/16, 1.1/8, 1.3/16, 1.1/4, 1.5/16, 1.3/8, 1.7/16, 1.1/2, 1.9/16, 1.5/8, 1.11/16, 1.3/4, 1.13/16, 1.7/8, 2		6749	
		6760-75	
 6101 Drag Link Socket		6760-200	
		6760-400	
		6770	
		6785	

6268M Socket Sets Juegos de Vasos

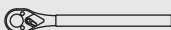
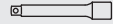

6268M		15 Pieces Set/△=12,500g	
METAL CASE:W580×H124×T70mm			
Sockets		Accessories	
 6405M 12-pt. Sockets 19, 22, 24, 27, 29, 30, 32, 36, 38, 41, 46, 50		6749	
		6760-200	
		6768	

Z-SERIES
HAND
MANUALES
TITANIUM
DE TITANIO
ACCESSORIES
ACCESORIOS
SCREWDRIVERS
DESTORNILLADORES
DE IMPACTO
SLEEVE-DRIVE
INDUSTRIAL
INDUSTRIALES
PROTECTOR
PROTECTORES
AUTOMOTIVE
CONSTRUCTION
CONSTRUCCION
RENEWAL KITS
JUEGOS DE PIEZAS/REPOSTO

8400M • 8400A

6-point Sockets
Vasos Hexagonales

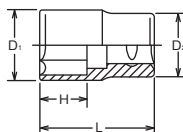

8400M 8405M (mm)	D ₁ (mm)	D ₂ (mm)	H (mm)	L (mm)	(g)	(pce.)
24	36.5	44	17	60	348	1
27	40.5	44	19	60	362	1
28	41.5	44	19.5	60	368	1
29	43	44	20	60	378	1
30	44	45	21	65	410	1
32	46.5	45	23	65	455	1
33	48	46	23.5	65	485	1
34	49	46	24	65	500	1
35	50.5	48	24.5	65	536	1
36	51.5	48	25	65	600	1
38	54	50	26	65	624	1
39	55.5	50	26.5	65	650	1
40	56.5	53	27	65	686	1
41	58	53	28	68	747	1
42	59	53	28.5	68	789	1
43	60.5	53	29	68	810	1
45	63	53	30	68	844	1
46	64	53	31	72	928	1
47	65.5	53	31.5	72	942	1
48	66.5	53	32	72	960	1
50	69	53	34	72	943	1
52	71.5	53	38	72	987	1
54	74	55	37	72	1016	1
55	75.5	53	42	77	1167	1
56	76.5	53	42	77	1160	1
58	79	53	41	77	1200	1
60	81.5	58	46	82	1440	1
62	84	58	46	82	1510	1
63	85.5	58	45	82	1470	1
64	86.5	58	46	82	1540	1
65	88	63	49	86	1683	1
67	90.5	63	49	86	1840	1
68	91.5	63	49	86	1800	1
70	94	68	50	88	1963	1
71	95.5	68	50	88	2200	1
72	96.5	68	51	88	2250	1
75	100.5	73	53	90	2204	1
78	104	75	52.5	90	2500	1
80	106.5	75	58	95	2550	1
83	110.5	78	57	95	2730	1
85	113	80	57	95	2680	1
90	119	80	59	100	3420	1
95	125.5	85	58	100	4900	1
100	131.5	85	57	100	4840	1

8405M • 8405A

12-point Sockets
Vasos Bihexagonales

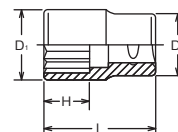
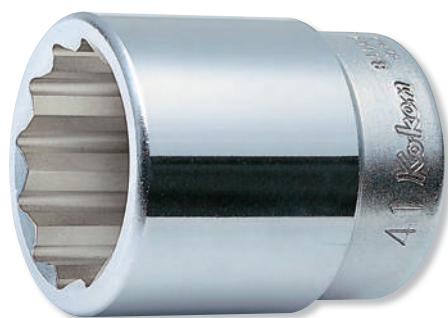

8400A 8405A (inch)	D ₁ (mm)	D ₂ (mm)	H (mm)	L (mm)	(g)	(pce.)
15/16	36.5	44	17	60	355	1
1. 3/16	44	45	21	65	410	1
1. 1/4	46.5	45	23	65	455	1
1. 5/16	48	46	23.5	65	485	1
1. 3/8	50.5	48	24.5	65	536	1
1. 7/16	53	50	25.5	65	607	1
1. 1/2	54	50	26	65	624	1
1. 9/16	56.5	53	27	65	686	1
1. 5/8	58	53	28	68	747	1
1.11/16	60.5	53	29	68	830	1
1. 3/4	61.5	53	29.5	68	807	1
1.13/16	64	53	31	72	928	1
1. 7/8	66.5	53	32	72	936	1
1.15/16	68	53	32.5	72	941	1
2	70.5	53	37	72	976	1
2. 1/16	73	54	37	72	1027	1
2. 1/8	74	55	37	72	1016	1
2. 3/16	76.5	53	41	77	1192	1
2. 1/4	78	53	41	77	1177	1
2. 5/16	80.5	53	41	77	1292	1
2. 3/8	81.5	58	46	82	1440	1
2. 7/16	84	58	45	82	1495	1
2. 1/2	86.5	58	45	82	1497	1
2. 9/16	88	63	49	86	1683	1
2. 5/8	90.5	63	49	86	1840	1
2.11/16	91.5	63	49	86	1800	1
2. 3/4	94	68	50	88	1963	1
2.13/16	96.5	68	50	88	2035	1
2. 7/8	98	70	50	88	2100	1
2.15/16	100.5	73	53	90	2204	1
3	103	75	53	90	2406	1
3. 1/8	106.5	75	58	95	2550	1
3. 1/4	110.5	78	57	95	2730	1
3. 3/8	114	80	57	95	3050	1
3. 1/2	119	80	59	100	3420	1
3. 3/4	125.5	85	58	100	4900	1

8012M.80 (mm)	D (mm)	H ₁ (mm)	H ₂ (mm)	L (mm)	(g)	(pcs.)
17	44.2	15.5	45	80	400	5
19	44.2	15.5	45	80	410	5
22	47.9	22.5	45	80	436	5
24	47.9	22.5	45	80	471	5
27	47.9	22.5	45	80	526	5
30	47.9	22.5	45	80	658	5
32	47.9	22.5	45	80	715	5
36	54.2	22.5	45	80	945	5

8012M-80 Inhex Sockets Vasos con Punta de Hexagonal

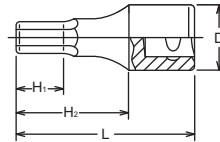

8760 Extension Bars Alargaderas

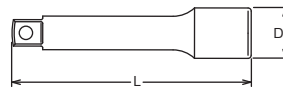

8760	D (mm)	L (mm)	(g)	(pce.)
200	44	200	1300	1
400	44	400	2570	1

8770 Universal Joint Articulación Universal

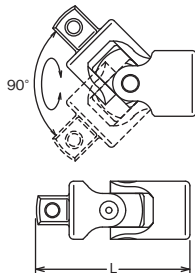

8770	L (mm)	(g)	(pce.)
8770	143	1170	1

8866A Adaptor Warranty 1850Nm Adaptador Garantía 1850Nm

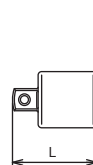

8866A	(mm)	(mm)	L (mm)	(g)	(pcs.)
8866A	1"	3/4"	60	338	5

 Adapting down from bigger square drive to smaller square drive may lead to excessive torque and possibly cause breakage.

La adaptación de mayor a menor de un cuadrado conductor puede conducir a un par excesivo que puede causar roturas.

Z-SERIES
HAND
MANUALES
TITANIUM
DE TITANIO
ACCESSORIES
ACCESORIOS
SCREWDRIVERS
DESTORNILLADORES
IMPACT
DE IMPACTO
SLEEVE-DRIVE
INDUSTRIAL
INDUSTRIALES
PROTECTOR
PROTECTORES
AUTOMOTIVE
CONSTRUCTION
CONSTRUCCION
RENEWAL KITS
JUEGOS DE PIEZAS/REPUESTO

Z-SERIES
HAND
MANUALES
TITANIUM
DE TITANIO
ACCESSORIES
ACCESORIOS
SCREWDRIVERS
DESTORNILLADORES
IMPACT
DE IMPACTO
SLEEVE-DRIVE
INDUSTRIAL
INDUSTRIALES
PROTECTOR
PROTECTORES
AUTOMOTIVE
CONSTRUCTION
CONSTRUCCIÓN
RENEWAL KITS
JUEGOS DE PIEZAS/REPUESTO

8749 Reversible Ratchet
Llave de Carraca Reversible

8749-1000 ⚠

8749-HEAD

PIPE-580 · -800



RATCHET
HANDLE

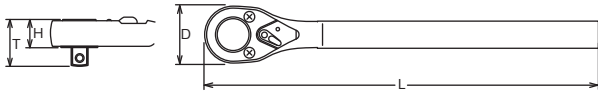

* Renewal Kits → 8749RK → P304

	D (mm)	T (mm)	H (mm)	L (mm)	(g)	(pce.)
8749	70	62.2	36.2	800	4090	1
8749-1000	70	62.2	36.2	1020	4664	1
New 8749-HEAD	70	62.2	36.2	220	2490	1
New PIPE-580	-	-	-	580	1610	1
New PIPE-800	-	-	-	800	2230	1

⚠ 8749-1000 have longer handle than standard, and can be loaded to excessive torque value. In the interest of your own safety always apply load evenly and progressively to avoid breakage and possible injury.

8768 Hinge Handle
Mango Articulado

8768-1000 ⚠

8768-HEAD

PIPE-400 · -800



* Renewal Kits → 8768RK → P306

	D (mm)	L (mm)	(g)	(pce.)
8768	55	600	3190	1
8768-1000	55	1000	4348	1
New 8768-HEAD	55	200	1480	1
New PIPE-400	-	400	1110	1
New PIPE-800	-	800	2230	1

⚠ 8768-1000 have longer handle than standard, and can be loaded to excessive torque value. In the interest of your own safety always apply load evenly and progressively to avoid breakage and possible injury.

8785 T-Handle
Mango Corredizo

8785-700 ⚠

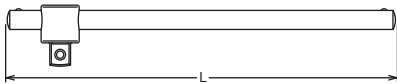

	L (mm)	(g)	(pce.)
8785	550	3190	1
8785-700	700	3906	1

⚠ 8785-700 have longer handle than standard, and can be loaded to excessive torque value. In the interest of your own safety always apply load evenly and progressively to avoid breakage and possible injury.

8788 L-Handle
Mango Acodado



	L (mm)	(g)	(pce.)
8788	600	3600	1

1" Hand Sockets













Z-SERIES	HAND MANUALES	TITANIUM DE TITANIO	ACCESSORIES ACCESORIOS	SCREWDRIVERS DESTORNILLADORES	IMPACT DE IMPACTO	SLEEVE-DRIVE	INDUSTRIAL INDUSTRIALES	PROTECTOR PROTECTORES	AUTOMOTIVE	CONSTRUCTION CONSTRUCCION	RENEWAL KITS JUEGOS DE PIEZAS/REPUERTO
----------	---------------	---------------------	------------------------	-------------------------------	-------------------	--------------	-------------------------	-----------------------	------------	---------------------------	--

Z-SERIES
HAND MANUALES
TITANIUM DE TITANIO
ACCESSORIES ACCESORIOS
SCREWDRIVERS DESTORNILLADORES
IMPACT DE IMPACTO
SLEEVE-DRIVE
INDUSTRIAL INDUSTRIALES
PROTECTOR PROTECTORES
AUTOMOTIVE
CONSTRUCTION CONSTRUCCION
RENEWAL KITS JUEGOS DE PIEZAS REPUSTO

8200M • 8200A Socket Sets Juegos de Vasos







8200M 12 Pieces Set/🔧=18,600g	
METAL CASE:W600xH150xT110mm	
Sockets	Accessories
 8405M 12-pt. Sockets 35, 38, 41, 46, 50, 54, 58, 63	 8760-200  8760-400  8770  8785

8200A 12 Pieces Set/🔧=18,600g	
METAL CASE:W600xH150xT110mm	
Sockets	Accessories
 8405A 12-pt. Sockets 1.7/16, 1.1/2, 1.5/8, 1.13/16, 2, 2.1/8, 2.1/4, 2.1/2	 8760-200  8760-400  8770  8785

8225M Socket Set Juego de Vasos



8225M 15 Pieces Set/🔧=27,000g	
METAL CASE:W620xH217xT97mm	
Sockets	Accessories
 8405M 12-pt. Sockets 32, 33, 36, 41, 46, 50, 55, 60, 65, 70, 75, 80	 8749  8760-200  8760-400





Sockets in sets can be supplied in 6-pt. or 12-pt. format.

Titanium Sockets

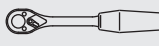

TI4261M Socket Set Titanium
Juego de Vasos de Titanio



TI4261M		18 Pieces Set/Δ=4,280g	
WOODEN CASE:W445xH190xT60mm			
Sockets		Accessories	
	TI4400M 6-pt. Sockets 8, 10, 11, 12, 13, 14, 17, 19, 21, 22, 24, 26, 27		TI4749J
			TI4760-125
			TI4760-250
			TI4768J-380
			TI4770

Characteristic of Titanium

- Light weight** : Makes it effective for operating tools. The specific gravity is only about 58% of chrome molybdenum steel which is used for our normal products.
- Non-Corrosion** : Corrosion Resistance is greatly improved against salt water and any kind of chemical products.
- Non-Magnetic** : Non-Magnetic material will prevent the tools from magnetizing.

Características del Titanio

- Peso ligero** : Aumenta la eficiencia de las herramientas de trabajo. El peso específico es aproximadamente sólo el 58% del acero al cromo-molibdeno de nuestros productos normales.
- No se oxida** : Se aumenta significativamente la resistencia a la corrosión por ambiente salino o por cualquier clase de productos químicos.
- No es magnético** : Material paramagnético que evita la magnetización de las herramientas.

Pentagonal drive is designed to avoid using with normal square drive items, so that it will provide extra safety and much more strength.

El diseño de conductor pentagonal evita su utilización con conductores normales cuadrados, proporcionando más seguridad y mucha mayor resistencia.



Accessories



Z-SERIES
HAND
MANUALES
TITANIUM
DE TITANIO
ACCESSORIES
ACCESORIOS
SCREWDRIVERS
DESTORNILLADORES
IMPACT
DE IMPACTO
SLEEVE-DRIVE
INDUSTRIAL
INDUSTRIALES
PROTECTOR
PROTECTORES
AUTOMOTIVE
CONSTRUCTION
RENEWAL KITS
JUEGOS DE PIEZAS REPUËSTO CONSTRUCCION

4100M • 4100A

 Screw and Stud Pullers
Extractores de Espárragos y Tornillos

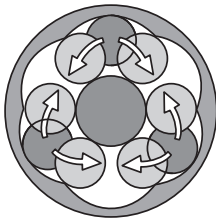
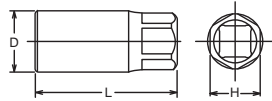



Screw and Stud Pullers

Hexagon body design can lessen the excessive load on cages and rollers inside the pullers.

Extractores de Tornillos y Espárragos

El diseño hexagonal del cuerpo evita cargas excesivas en las celdas y rodillos internos del extractor.

4100M (mm)		D (mm)	L (mm)	H (mm)	(g)	(pcs.)
5	1/2"	24	65	21	145	10
6		24	65	21	150	10
7		24	65	21	150	10
8		24	65	21	147	10
9		28	75	21	217	10
10		28	75	21	213	10
10.5		28	75	21	202	10
11		28	75	21	218	10
12		28	75	21	220	10
14		34	75	27	340	5
16	-⚠	34	75	27	315	5

4100A (inch)		D (mm)	L (mm)	H (mm)	(g)	(pcs.)
1/4	1/2"	24	65	21	150	10
5/16		24	65	21	147	10
3/8		28	75	21	213	10
7/16		28	75	21	218	10
1/2		28	75	21	191	10
9/16		34	75	27	340	5
5/8	-⚠	34	75	27	315	5

* Renewal Kits → 4100MRK/4100ARK → P307

⚠ 4100M-16 and 4100A-5/8 do not have 1/2" square drive.
Drive the outer hexagon part with 27mm sockets or ring wrenches.

4100M-16 y 4100A-5/8 no tienen conductores cuadrados de 1/2"
Apretar la parte hexagonal exterior con vasos de 27mm o llaves de tuerca.

Tolerance/Tolerancia

4100M (mm)	4100A (inch)
5	1/4
6	5/16
7	3/8
8	7/16
9	1/2
10	9/16
10.5	5/8
11	
12	
14	
16	

4211M • 4211A

 Screw and Stud Pullers Sets
Juegos de Extractores de Tornillos y Espárragos



4211M	4 Pieces Set/△=1,040g
METAL CASE:W215xH80xT47mm	
PULLER	
	4100M Stud Pullers 6, 8, 10, 12

4211A	4 Pieces Set/△=1,040g
METAL CASE:W215xH80xT47mm	
PULLER	
	4100A Stud Pullers 1/4, 5/16, 3/8, 1/2

4214M

 Screw and Stud Pullers Set
Juegos de Extractores de Tornillos y Espárragos



4214M	5 Pieces Set/△=1,450g
METAL CASE:W215xH80xT47mm	
PULLER	
	4100M Stud Pullers 6, 8, 10, 12, 14

6100M (mm)	□	D (mm)	L (mm)	H (mm)	(g)	(pcs.)
18	3/4"	48	100	36	840	1
20		48	100	36	816	1
22		48	100	36	745	1
24	⚠	48	100	36	739	1
27		63	125	46	1707	1
28		63	125	46	1701	1
29		63	125	46	1696	1
30		63	125	46	1691	1

* Renewal Kits → 6100MRK → P307

⚠ 6100M-22 to -30 do not have 3/4" square drive.
Drive the outer hexagon part with sockets or ring wrenches (size 22-24mm = 36H, 27-30mm = 46H).

6100M-22-30 no tienen conductores cuadrados de 3/4"
Apretar la parte hexagonal exterior con vasos o llaves de tuerca (medidas 22-24mm = 36H, 27-30mm = 46H)

Tolerance/Tolerancia

6100M (mm)	Tolerance/Tolerancia
18	16.9-18
20	18.8-20
22	20.8-22
24	22.7-24
27	25.7-27
28	26.7-28
29	27.6-29
30	28.6-30

14100M (mm)	□	D ₁ (mm)	D ₂ (mm)	L (mm)	(g)	(pcs.)	⚡
6	1/2"	24	25	48	126	10	*1
7		24	25	48	126	10	*1
8		24	25	48	122	10	*1
9		28	30	48	181	10	*2
10		28	30	48	181	10	*2
12		28	30	48	175	10	*2

14100A (inch)	□	D ₁ (mm)	D ₂ (mm)	L (mm)	(g)	(pcs.)	⚡
1/4	1/2"	24	25	48	126	10	*1
5/16		24	25	48	122	10	*1
3/8		28	30	48	181	10	*2
7/16		28	30	48	181	10	*2
1/2		28	30	48	180	10	*2

*1 C-Ring=1401C, Pin/O-Ring=1401A/B
*2 C-Ring=1402C, Pin/O-Ring=1402A/B

→ P254-255

Tolerance/Tolerancia

14100M (mm)	14100A (inch)
6	5.6- 6
7	6.6- 7
8	7.6- 8
9	8.4- 9
10	9.4-10
12	11.4-12

6100M ○ Screw and Stud Pullers
Extractores de Tornillos y Espárragos

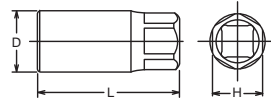

14100M • 14100A ○ Impact Screw and Stud Pullers
Extractores de Tornillos y Espárragos de Impacto

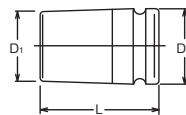

Z-SERIES
HAND
MANUALES
TITANIUM
DE TITANIO
ACCESSORIES
ACCESORIOS
SCREWDRIVERS
DESTORNILLADORES
IMPACT
DE IMPACTO
SLEEVE-DRIVE
INDUSTRIAL
INDUSTRIALES
PROTECTOR
PROTECTORES
AUTOMOTIVE
CONSTRUCTION
CONSTRUCCION
RENEWAL KITS
JUEGOS DE PIEZAS/REPUESTO

Stud Puller & Setter

Z-SERIES
HAND MANUALES
TITANIUM DE TITANIO
ACCESSORIES ACCESORIOS
SCREWDRIVERS DESTORNILLADORES
IMPACT DE IMPACTO
SLEEVE-DRIVE
INDUSTRIAL INDUSTRIALES
PROTECTOR PROTECTORES
AUTOMOTIVE
RENEWAL KITS CONSTRUCTION JUEGOS DE PIEZAS REPUES TO CONSTRUCCION

141S Stud Puller Ratchets Extractores de Espárragos de Carraca



141S (mm)	D (mm)	L (mm)	(g)	(pce.)
6	28	120	150	1
8	28	120	150	1
10	32	120	153	1
12	32	120	152	1

141 Stud Puller Ratchets Extractores de Espárragos de Carraca



141 (inch)	D (mm)	L (mm)	(g)	(pce.)
5/16	28	120	150	1
3/8	32	120	153	1
1/2	32	120	152	1

141 (mm)	D (mm)	L (mm)	(g)	(pce.)
6	28	205	215	1
8	28	205	215	1
10	32	205	234	1
12	32	205	233	1

141 (inch)	D (mm)	L (mm)	(g)	(pce.)
5/16	28	205	215	1
3/8	32	205	234	1
1/2	32	205	233	1

141P Stud Puller Ratchets Extractores de Espárragos de Carraca

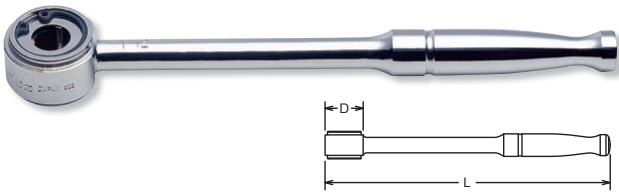

141P (mm)	D (mm)	L (mm)	(g)	(pce.)
6	28	205	210	1
8	28	205	210	1
10	32	205	229	1
12	32	205	227	1

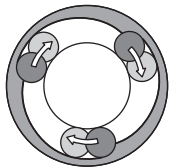

The three roller system can protect the studs from damage.

El sistema de tres rodillos puede proteger los espárragos de cualquier daño.



1201 Stud Puller Ratchets Set Juego de Extractores de Espárragos de Carraca



1201 4 Pieces Set/973g

METAL CASE:W240xH100xT32mm

PULLER

141S Stud Puller Ratchet
6, 8, 10, 12

4104 Screw and Stud Puller Extractor de Tornillos y Espárragos



4104	1/2	Tolerance		D (mm)	L (mm)	(g)	(pcs.)
		min	max				
		φ 6	φ 19	54	56	489	2

4103M (mm)	□	D ₁ (mm)	D ₂ (mm)	H (mm)	L (mm)	(g)	(pcs.)
6(1.0)	1/2"	10.3	22	9	37	54	10
7(1.0)		11.5	22	10	37	58	10
8(1.25)		13.2	22	11	37	60	10
10(1.25)		15.3	23	13	44	86	10
10(1.5)		15.3	23	13	44	86	10
12(1.25)		17.8	23	14	44	86	10
12(1.75)		17.8	23	14	44	86	10

⚠ Depend on the stud bolt and using torque, 4103M/13103M/14103M may cause a scratch against the stud bolts or got stuck itself during a work.



4203M	4 Pieces Set/△=530g
METAL CASE:W130xH65xT26mm	
Stud Bolt Setter	
○ 4103M Stud Bolt Setters	
6(1.0), 8(1.25), 10(1.5), 12(1.75)	
4203MF	4 Pieces Set/△=530g
METAL CASE:W130xH65xT26mm	
Stud Bolt Setter	
○ 4103M Stud Bolt Setters	
6(1.0), 8(1.25), 10(1.25), 12(1.25)	

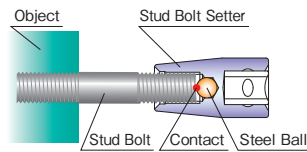

A special socket for installing a stud bolt. Inside steel ball prevent the stud bolt stuck onto the socket. After installing a stud bolt, turn to anti-clockwise to removing the socket.

13103M (mm)	□	D ₁ (mm)	D ₂ (mm)	H (mm)	L (mm)	(g)	(pcs.)	⊕
5(0.8)	3/8"	9.5	19	8	32	39	10	*1
6(1.0)		10.8	19	9	32	41	10	*1
7(1.0)		12.5	19	10	32	44	10	*1
8(1.25)		13.5	19	11	35	49	10	*1
10(1.25)		15.8	19	13	35	49	10	*1
10(1.5)		15.8	19	13	35	49	10	*1

*1 C-Ring=1301C, Pin/O-Ring=1301A/B → P254-255

⚠ Depend on the stud bolt and using torque, 4103M/13103M/14103M may cause a scratch against the stud bolts or got stuck itself during a work.

14103M (mm)	□	D ₁ (mm)	D ₂ (mm)	H (mm)	L (mm)	(g)	(pcs.)	⊕
6(1.0)	1/2"	12	25	11	42	75	10	*1
7(1.0)		13.2	25	12	42	78	10	*1
8(1.25)		14.5	25	15	42	81	10	*1
10(1.25)		17	25	18	49	106	10	*1
10(1.5)		17	25	18	49	106	10	*1
12(1.25)		19.5	25	19	49	107	10	*1
12(1.75)		19.5	25	19	49	107	10	*1
14(1.5)		22	25	21	55	128	10	*1
14(2.0)		22	25	21	55	128	10	*1

*1 C-Ring=1401C, Pin/O-Ring=1401A/B → P254-255

⚠ Depend on the stud bolt and using torque, 4103M/13103M/14103M may cause a scratch against the stud bolts or got stuck itself during a work.

4103M ○ Stud Bolt Setters Vasos para apretar pernos ⚠

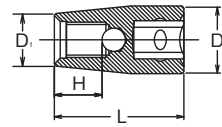

4203M ○ Stud Bolt Setters Set Juego de Vasos para apretar Pernos
4203MF ○



13103M ○ Impact Stud Bolt Setters Vasos para apretar Pernos de Impacto ⚠

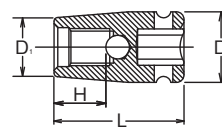

14103M ○ Impact Stud Bolt Setters Vasos para apretar Pernos de Impacto ⚠

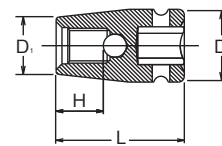



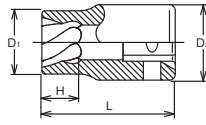

Z-SERIES
 HAND
 MANUALES
 TITANIUM
 DE TITANIO
 ACCESSORIES
 ACCESORIOS
 SCREWDRIVERS
 DESTORNILLADORES
 IMPACT
 DE IMPACTO
 SLEEVE-DRIVE
 INDUSTRIAL
 INDUSTRIALES
 PROTECTOR
 PROTECTORES
 AUTOMOTIVE
 CONSTRUCTION
 CONSTRUCCION
 RENEWAL KITS
 JUEGOS DE HEZAS/REPLUSTO

Z-SERIES
HAND MANUALES
TITANIUM DE TITANIO
ACCESSORIES ACCESORIOS
SCREWDRIVERS DESTORNILLADORES
IMPACT DE IMPACTO
SLEEVE-DRIVE
INDUSTRIAL INDUSTRIALES
PROTECTOR PROTECTORES
AUTOMOTIVE
CONSTRUCTION CONSTRUCCIÓN
RENEWAL KITS JUEGOS DE PIEZAS REPUESTO

2127  NUTTWISTER® AFLOJA TUERCAS



2127 (mm)		D ₁ (mm)	D ₂ (mm)	H (mm)	L (mm)	 (g)	 (pcs.)
4		7	13	4	23	14	10
4.5		7.4	13	4	23	14	10
5		8	13	5	23	14	10
5.5		8.8	13	5	23	14	10
6		9.5	13	6	23	14	10
7		10.9	13	6	23	14	10
8		11.5	13	8	23	14	10
9		13	13	8	23	15	10
9.5		13.8	13	10	23	16	10
10		14.8	13	10	23	17	10

RS2127/6   Socket Set on Rail Juego de Vasos en Regleta



RS2127/6	6 Pieces Set/Rail 150mm	 (g)
4, 4.5, 5, 5.5, 6, 7		105





RS2127/10   Socket Set on Rail Juego de Vasos en Regleta

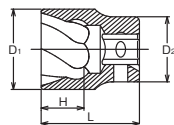

RS2127/10	10 Pieces Set/Rail 150mm	 (g)
4, 4.5, 5, 5.5, 6, 7, 8, 9, 9.5, 10		180

3127  NUTTWISTER® AFLOJA TUERCAS



3127 (mm)		D ₁ (mm)	D ₂ (mm)	H (mm)	L (mm)	 (g)	 (pcs.)
8		11.5	19	8	32	40	10
9		13	19	8	32	40	10
9.5		13.8	19	8	32	41	10
10		14.8	19	10	32	41	10
11		16	19	10	32	43	10
12		17	19	12	32	44	10
13		18.5	19	12	32	46	10
14		19.7	19	14	32	48	10
15		20.7	19	14	32	52	10
16		22.2	22	14	32	66	10
17	23.5	22	16	35	80	10	
19	26	22	16	35	92	10	

RS3127/8   Socket Set on Rail Juego de Vasos en Regleta



RS3127/8	8 Pieces Set/Rail 200mm	 (g)
8, 9, 10, 11, 12, 13, 14, 16		420

3128.80 (mm)		D ₁ (mm)	D ₂ (mm)	H (mm)	L (mm)	(g)	(pcs.)
8	3/8"	11.5	19	6	80	58	10
9		13	19	6	80	61	10
10		14.8	19	8	80	66	10
11		16	19	8	80	70	10
12		17	19	10	80	77	10
13		18.5	19	10	80	80	10
14		19.7	19	12	80	82	10

3128-80 NUTTWISTER® (Long type)
AFLOJA TUERCAS (Serie Larga)

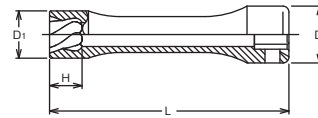

4127 (mm)		D ₁ (mm)	D ₂ (mm)	H (mm)	L (mm)	(g)	(pcs.)
14	1/2"	19.7	30	14	42	125	5
17		23.5	30	16	42	137	5
19		26	30	16	42	146	5
21		28	30	17	42	153	5
22		29.5	30	17	42	158	5
24		32	30	18	42	174	5
25.4		33.5	30	18	42	183	5

4127 NUTTWISTER®
AFLOJA TUERCAS

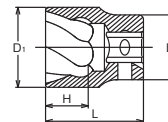

RS4127/6	6 Pieces Set/Rail 200mm	(g)
17, 19, 21, 22, 24, 25.4		960

RS4127/6 Socket Set on Rail
Juego de Vasos en Regleta



4128-120 NUTTWISTER® (Long type)
AFLOJA TUERCAS (Serie Larga)

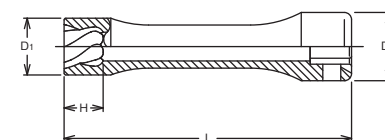

4128.120 (mm)		D ₁ (mm)	D ₂ (mm)	H (mm)	L (mm)	(g)	(pcs.)
17	1/2"	23.5	30	16	120	227	10
19		26	30	16	120	247	10
21		28	30	17	120	262	10
22		29.5	30	17	120	259	10

A very effective method and easy solution for removing rounded off nuts, bolts and studs. The sharp edges of the NUTTWISTER® Socket opening will tighten around the nut, bolt or stud and turn it easily off.

Un método muy efectivo y una fácil solución para aflojar tuercas, pernos y espárragos redondeados por desgaste. Las afiladas aristas de la boca del vaso AFLOJA TUERCAS NUTTWISTER®, aprietan contra la tuerca, perno o espárrago, haciéndolo girar fácilmente.



Z-SERIES
HAND
MANUALES
TITANIUM
DE TITANIO
ACCESSORIES
ACCESORIOS
SCREWDRIVERS
DESTORNILLADORES
IMPACT
DE IMPACTO
SLEEVE-DRIVE
INDUSTRIAL
INDUSTRIALES
PROTECTOR
PROTECTORES
AUTOMOTIVE
CONSTRUCTION
RENEWAL KITS
JUEGOS DE PIEZAS/REPUERTO

Z-SERIES
HAND
MANUALES
TITANIUM
DE TITANIO
ACCESSORIES
ACCESORIOS
SCREWDRIVERS
DESTORNILLADORES
IMPACT
DE IMPACTO
SLEEVE-DRIVE
INDUSTRIAL
INDUSTRIALES
PROTECTOR
PROTECTORES
AUTOMOTIVE
CONSTRUCTION
RENEWAL KITS
JUEGOS DE PIEZAS/REPUÉS
CONSTRUCCIÓN

3129-32 BOLTTWISTER®
AFLOJA PERNOS

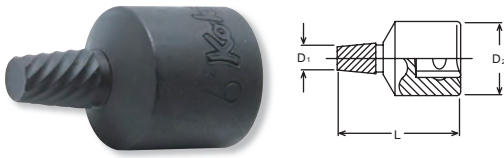

3129.32 (mm)	□	D ₁ (mm)	D ₂ (mm)	L (mm)	(g)	(pcs.)
2	3/8"	2	19	32	32	10
3		3	19	32	33	10
4		4	19	32	33	10
6		6	19	32	35	10
8		8	19	32	37	10
10		10	19	32	40	10

RS3129/6-L32 Socket Set on Rail
Juego de Vasos en Regleta



RS3129/6-L32	6 Pieces Set/Rail 150mm	(g)
2, 3, 4, 6, 8, 10		250

3129-60 BOLTTWISTER®
AFLOJA PERNOS

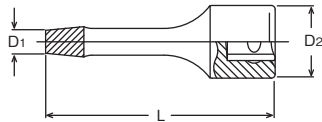

3129.60 (mm)	□	D ₁ (mm)	D ₂ (mm)	L (mm)	(g)	(pcs.)
2	3/8"	2	19	60	38	10
3		3	19	60	42	10
4		4	19	60	44	10
6		6	19	60	47	10
8		8	19	60	53	10
10		10	19	60	64	10

RS3129/6-L60 Socket Set on Rail
Juego de Vasos en Regleta





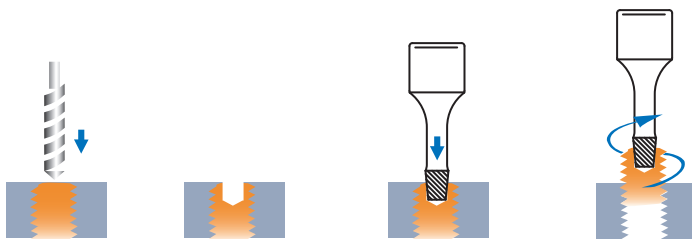

RS3129/6-L60	6 Pieces Set/Rail 150mm	(g)
2, 3, 4, 6, 8, 10		320







Effective method and easy solution for removing twisted off bolt. Drill a hole in the center of bolt and drive BOLTTWISTER® firmly into the hole. The sharp spiral edges will hold the broken bolt and easily remove it.

Un método efectivo y una fácil solución para aflojar pernos rotos. Taladrar un agujero en el centro del perno e introducir el AFLOJA PERNOS BOLTTWISTER® presionando y girando. Las afiladas aristas espirales agarran el perno roto sacándolo.

BOLTTWISTER	Bolt size	Drill size
2	M5	φ 2.4- 2.6
3	M6	φ 3.2- 3.5
4	M8	φ 4.2- 4.5
6	M10-M12	φ 6.2- 6.5
8	M14-M16	φ 8.2- 8.5
10	M18-M20	φ 10.2-10.5
12	M22-M24	φ 12.2-12.5
14	M27-M30	φ 14.2-14.5
16	M33	φ 16.2-16.5

4129.37 (mm)		D ₁ (mm)	D ₂ (mm)	L (mm)	 (g)	 (pcs.)
8		8	24	37	59	10
10		10	24	37	63	10
12		12	24	37	67	10
14		14	24	37	72	10
16		16	24	37	78	10

RS4129/5-L37	5 Pieces Set/Rail 150mm	 (g)
8, 10, 12, 14, 16		370

4129.75 (mm)		D ₁ (mm)	D ₂ (mm)	L (mm)	 (g)	 (pcs.)
8		8	24	75	80	10
10		10	24	75	94	10
12		12	24	75	110	10
14		14	24	75	130	10
16		16	24	75	150	10

RS4129/5-L75	5 Pieces Set/Rail 150mm	 (g)
8, 10, 12, 14, 16		600

4129-37 BOLTTWISTER® AFLOJA PERNOS

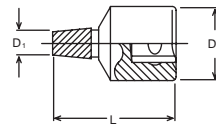

RS4129/5-L37  Socket Set on Rail
Juego de Vasos en Regleta



4129-75 BOLTTWISTER® AFLOJA PERNOS

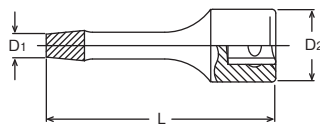

RS4129/5-L75  Socket Set on Rail
Juego de Vasos en Regleta



Z-SERIES
HAND
MANUALES
TITANIUM
DE TITANIO
ACCESSORIES
ACCESORIOS
SCREWDRIVERS
DESTORNILLADORES
IMPACT
DE IMPACTO
SLEEVE-DRIVE
INDUSTRIAL
INDUSTRIALES
PROTECTOR
PROTECTORES
AUTOMOTIVE
CONSTRUCTION
CONSTRUCCION
RENEWAL KITS
JUEGOS DE PIEZAS/REPOSTO

T-Type Wrench

Z-SERIES
HAND MANUALES
TITANIUM DE TITANIO
ACCESSORIES ACCESORIOS
SCREWDRIVERS DESTORNILLADORES
IMPACT DE IMPACTO
SLEEVE-DRIVE
INDUSTRIAL INDUSTRIALES
PROTECTOR PROTECTORES
AUTOMOTIVE
CONSTRUCTION CONSTRUCCIÓN
RENEWAL KITS JUEGOS DE PIEZAS REPUESTO

156M 6-point Deep Hexagonal Larga

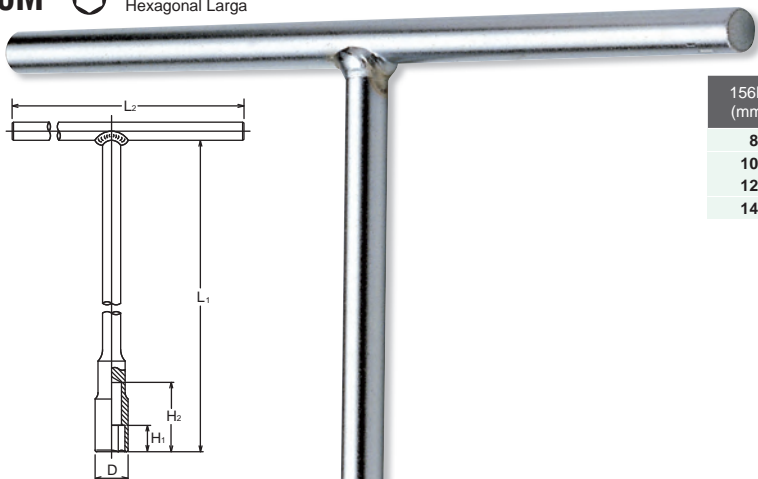

156M (mm)	D (mm)	H ₁ (mm)	H ₂ (mm)	L ₁ (mm)	L ₂ (mm)	(g)	(pce.)
8	12	9	41	355	200	231	1
10	14.5	11	41	355	200	289	1
12	16.8	13	41	355	200	429	1
14	20	16	41	355	200	454	1

104M • 104A 6-point Hexagonal

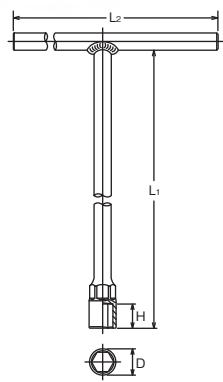

104M (mm)	D (mm)	H (mm)	L ₁ (mm)	L ₂ (mm)	(g)	(pce.)
6	9.5	8	200	180	150	1
7	11	9	200	180	152	1
8	12	10	250	200	183	1
9	14	12	250	200	188	1
10	14	13	250	200	230	1
11	16	14	250	200	234	1
12	18	15	250	250	384	1
13	18.5	17	300	250	412	1
14	20	18	300	250	428	1
15	21	19	300	250	443	1
16	22.5	21	350	300	528	1
17	24	22	350	300	707	1
18	25	23	350	300	707	1
19	26.5	25	350	300	717	1
21	29	27	350	300	1070	1
22	30	28	350	300	1062	1
24	33	30	350	300	1140	1

104A (inch)	D (mm)	H (mm)	L ₁ (mm)	L ₂ (mm)	(g)	(pce.)
1/4	9.5	8	200	180	150	1
5/16	12	10	250	200	183	1
3/8	14	12	250	200	188	1
7/16	16	14	250	200	234	1
1/2	18.5	17	300	250	412	1
9/16	20	18	300	250	428	1
5/8	22.5	21	350	300	528	1
3/4	26.5	25	350	300	717	1

3116M  Universal with 6-point Socket
Con articulación universal con Vaso Hexagonal

124M-600 (2B)  Ball Joint plus Nut Grip Socket
Con articulación de rótula y Vaso Sujeta Tuerca

3116M (mm)	D (mm)	H (mm)	L ₁ (mm)	L ₂ (mm)	(g)	(pce.)
10	14.5	8	800	190	796	1
12	17	10.3	800	190	797	1
13	18	11.3	800	190	797	1
14	19.5	11.3	800	190	797	1
15	21	12.8	800	190	799	1
16	22	12.8	800	190	806	1
17	23.6	13.8	800	190	801	1
18	24	13.8	800	190	809	1

124M.600 (mm)	D (mm)	H (mm)	L ₁ (mm)	L ₂ (mm)	(g)	(pce.)
8(2B)	12	5	600	200	332	1
10(2B)	14.5	6	600	200	334	1
12(2B)	16.8	7	600	200	424	1
13(2B)	18	8	600	200	425	1
14(2B)	19.5	8.5	600	200	527	1
17(2B)	23.3	9.5	600	200	538	1

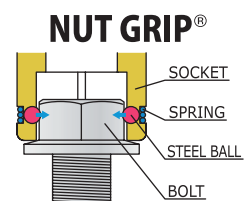
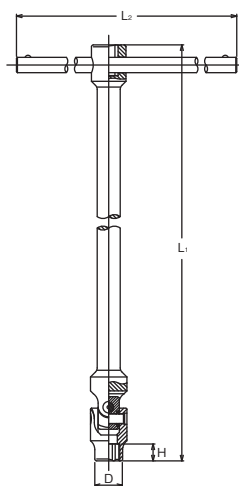

Twin balls at the 6-point opening hold bolt-nut tightly for safe and reliable work.

Las dos bolas de la boca Hexagonal sujetan el perno-tuerca permitiendo un trabajo seguro y fiable.

Z-SERIES
HAND
MANUALES
TITANIUM
DE TITANIO
ACCESSORIES
ACCESORIOS
SCREWDRIVERS
DESTORNILLADORES
IMPACT
DE IMPACTO
SLEEVE-DRIVE
INDUSTRIAL
INDUSTRIALES
PROTECTOR
PROTECTORES
AUTOMOTIVE
CONSTRUCTION
CONSTRUCCION
RENEWAL KITS
JUEGOS DE HERRAMIENTAS

T-Type Wrench

Z-SERIES
HAND MANUALES
TITANIUM DE TITANIO
ACCESSORIES ACCESORIOS
SCREWDRIVERS DESTORNILLADORES
IMPACT DE IMPACTO
SLEEVE-DRIVE
INDUSTRIAL INDUSTRIALES
PROTECTOR PROTECTORES
AUTOMOTIVE
CONSTRUCTION CONSTRUCCIÓN
RENEWAL KITS JUEGOS DE PIEZAS REPUESTO

157H



For Inhex Screws
Para Tornillos de Seis Lados en el Interior (Inhex)

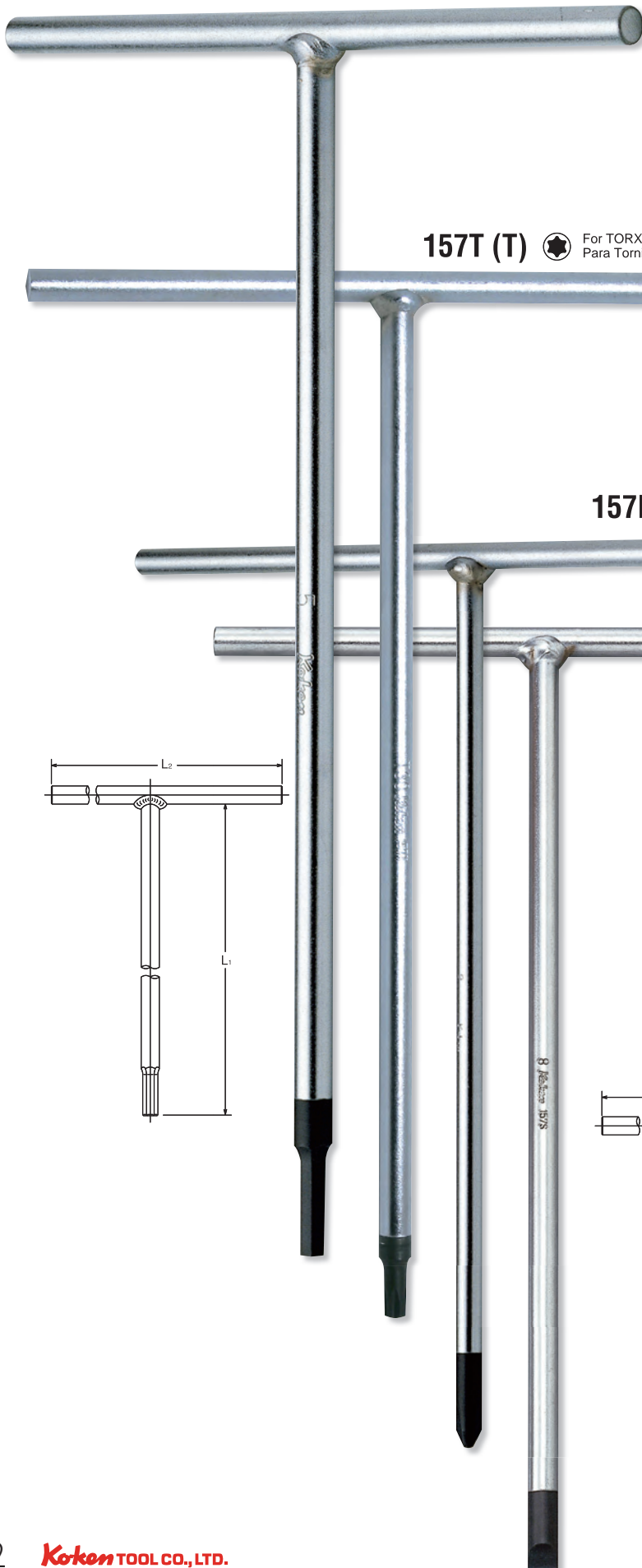

157H (mm)	L ₁ (mm)	L ₂ (mm)	(g)	(pce.)
3	160	100	57	1
4	200	120	70	1
5	250	160	90	1
6	300	190	147	1
7	300	190	193	1
8	300	190	245	1
10	300	190	433	1
12	320	210	662	1
14	340	220	879	1
17	340	220	1369	1

157T (T)



For TORX® Screws
Para Tornillos TORX®

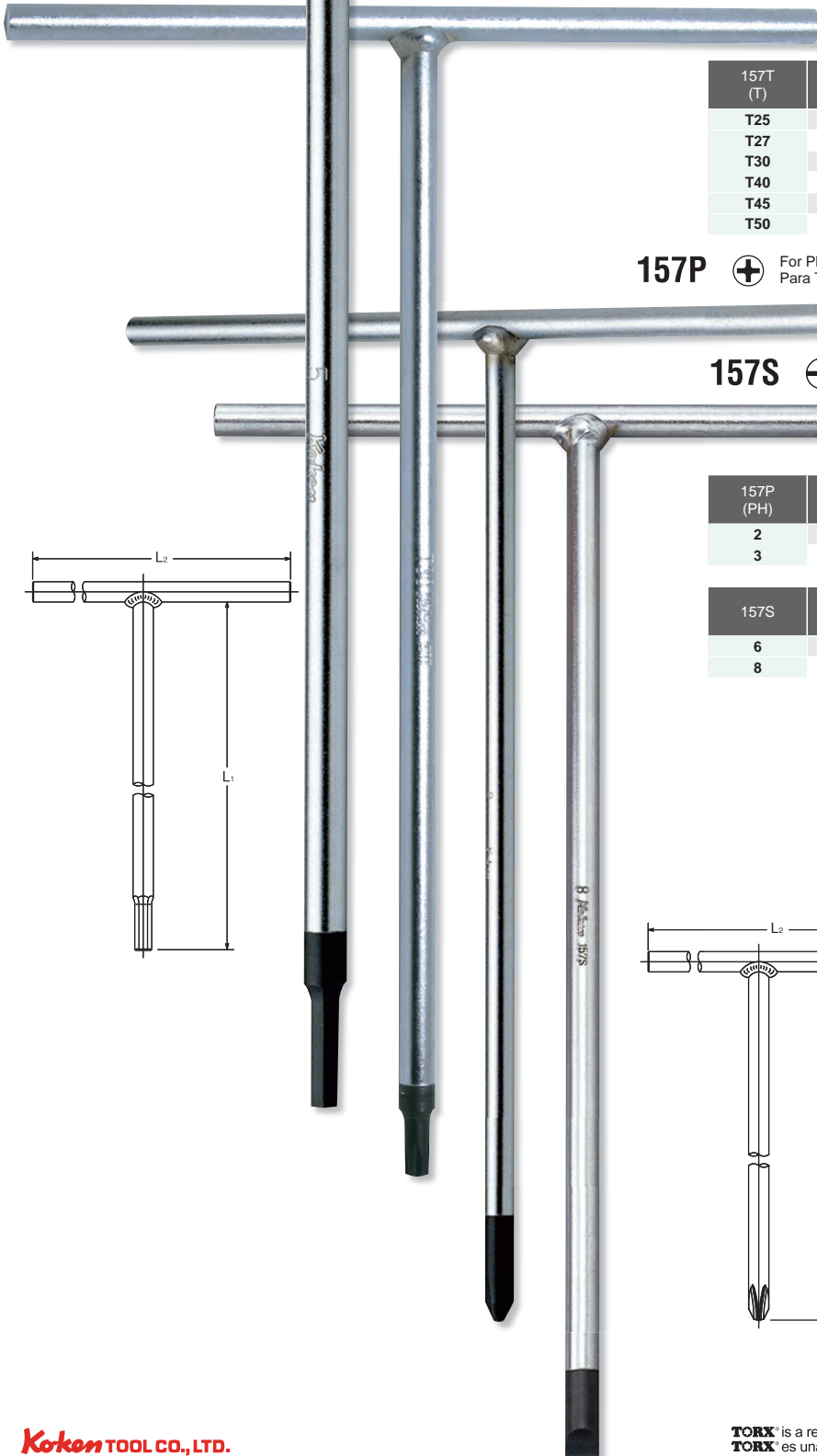

157T (T)	L ₁ (mm)	L ₂ (mm)	(g)	(pce.)
T25	250	180	95	1
T27	250	180	96	1
T30	250	180	167	1
T40	250	180	168	1
T45	250	180	213	1
T50	250	180	215	1

157P



For Phillips Screws
Para Tornillos Phillips

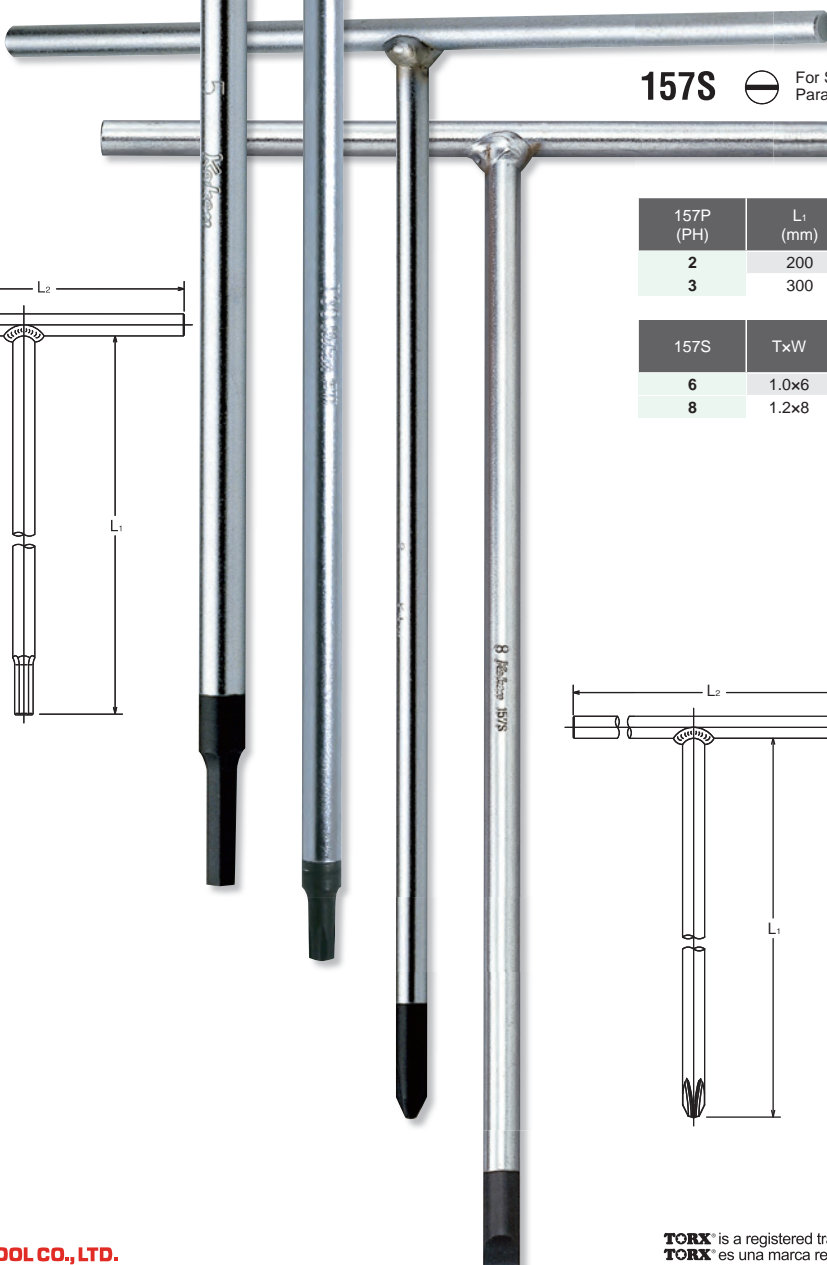

157P (PH)	L ₁ (mm)	L ₂ (mm)	(g)	(pce.)
2	200	180	84	1
3	300	180	189	1

157S	T×W	L ₁ (mm)	L ₂ (mm)	(g)	(pce.)
6	1.0×6	200	180	84	1
8	1.2×8	250	180	170	1

157S



For Slotted Heads
Para Cabezas Ranuradas

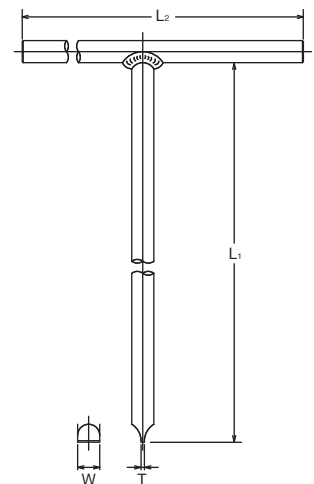
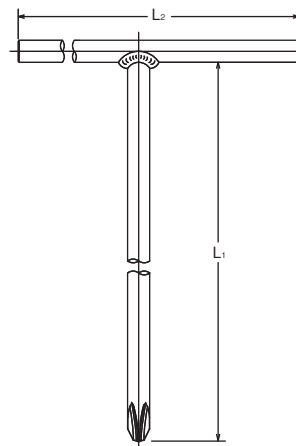
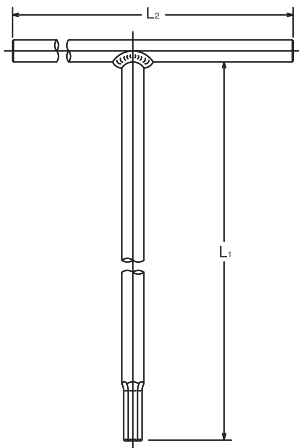
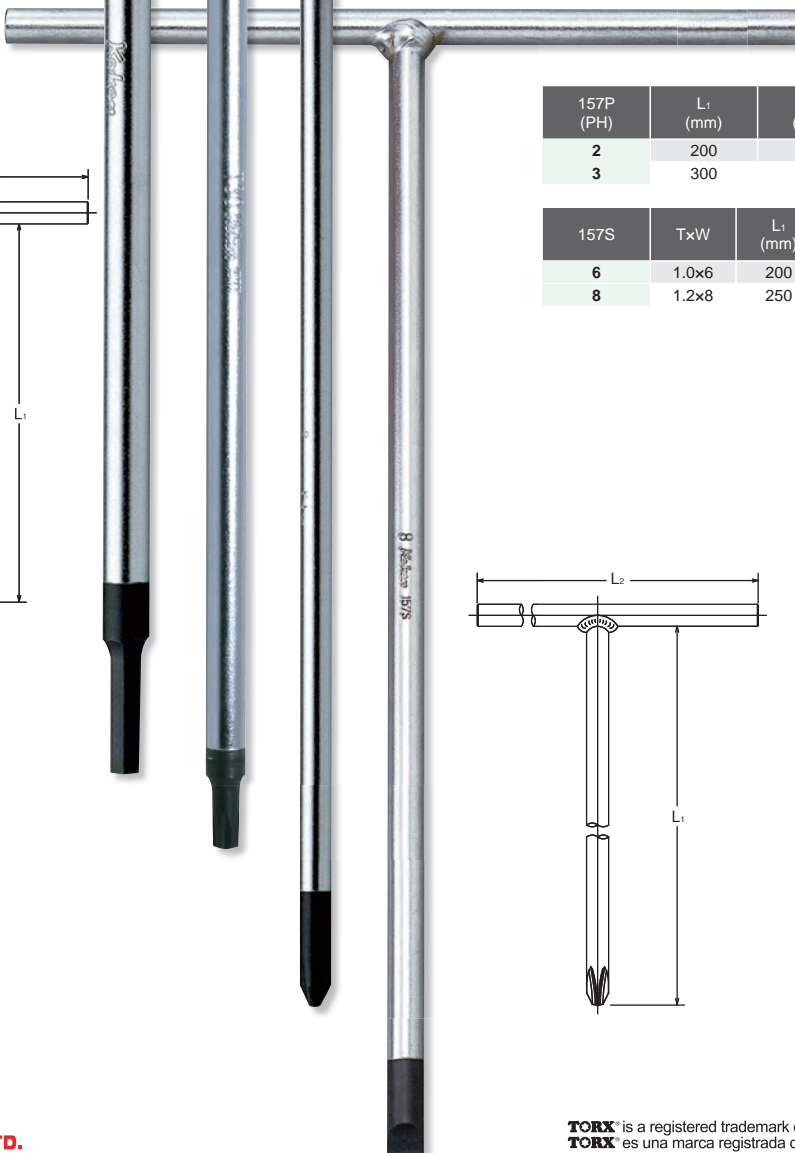

2715  T-Handle
Llaves en T



3715  T-Handle
Llaves en T

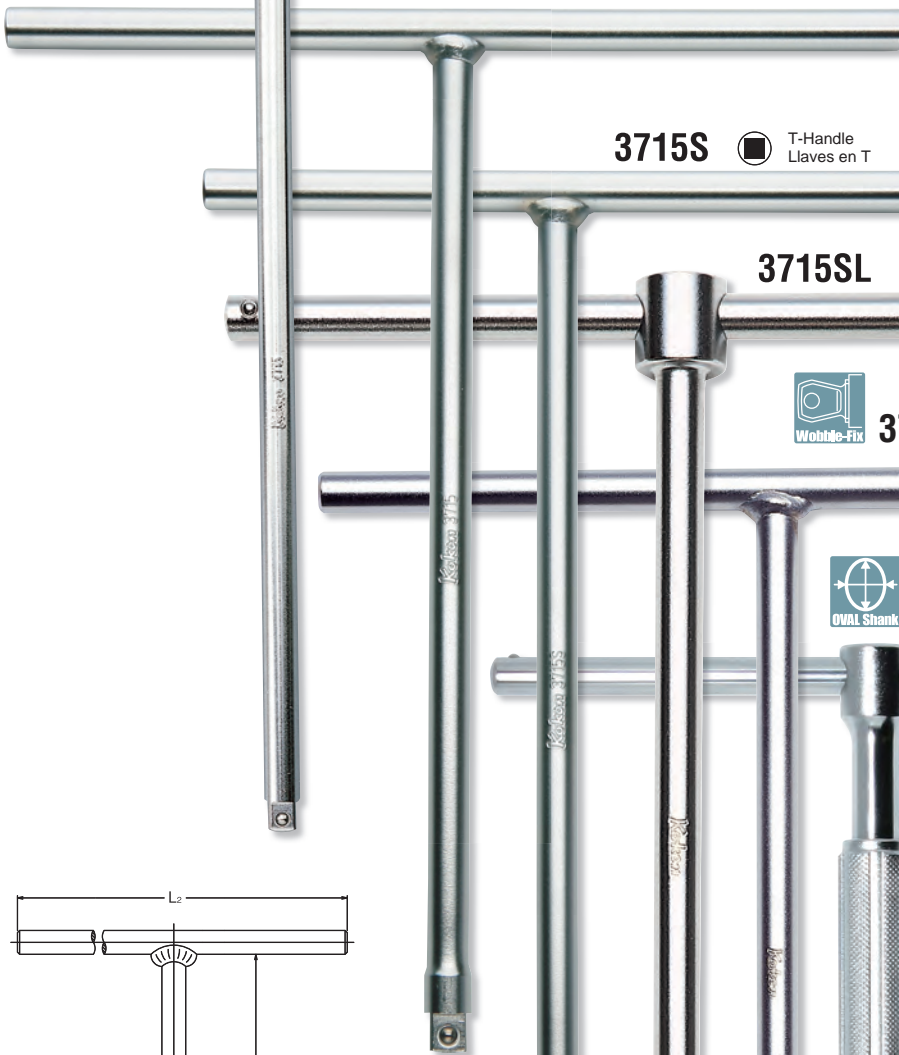

3715S  T-Handle
Llaves en T



3715SL  T-Handle
Llaves en T



3716  T-Handle
Llaves en T 



WOBBLE-FIX
EXTENSION BAR



3715SLK  T-Handle
Llaves en T



OVAL SHAPE
SHANK

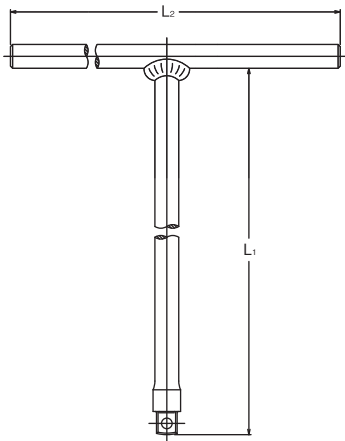





Photo: 3715SLK

		L ₁ (mm)	L ₂ (mm)	 (g)	 (pce.)
2715	1/4"	200	120	130	1

		L ₁ (mm)	L ₂ (mm)	 (g)	 (pce.)
3715	3/8"	268	240	386	1
3715S		268	190	347	1
3715SL		237	200	325	1
3715SLK		236	200	470	1
3716		268	240	379	1

 2715/3715/3716
This tool is used sockets in hard to reach places. 3716 has a reduced square drive and similar function as offset extension bars.

Z-SERIES
HAND
MANUALES
TITANIUM
DE TITANIO
ACCESSORIES
ACCESORIOS
SCREWDRIVERS
DESTORNILLADORES
IMPACT
DE IMPACTO
SLEEVE-DRIVE
INDUSTRIAL
INDUSTRIALES
PROTECTOR
PROTECTORES
AUTOMOTIVE
CONSTRUCTION
CONSTRUCCION
RENEWAL KITS
JUEGOS DE PIEZAS/REPOSTO

T-Type Wrench

Z-SERIES
HAND MANUALES
TITANIUM DE TITANIO
ACCESSORIES ACCESORIOS
SCREWDRIVERS DESTORNILLADORES
IMPACT DE IMPACTO
SLEEVE-DRIVE
INDUSTRIAL INDUSTRIALES
PROTECTOR PROTECTORES
AUTOMOTIVE
CONSTRUCTION CONSTRUCCION
RENEWAL KITS JUEGOS DE PIEZAS REPUSTO

4715  T-Handle
Llaves en T







4715S  T-Handle
Llaves en T

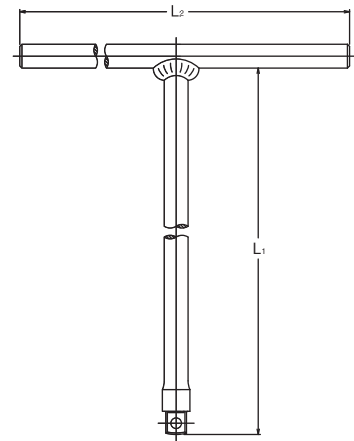

4715SL  T-Handle
Llaves en T





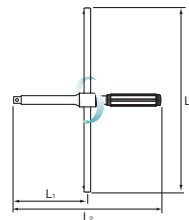
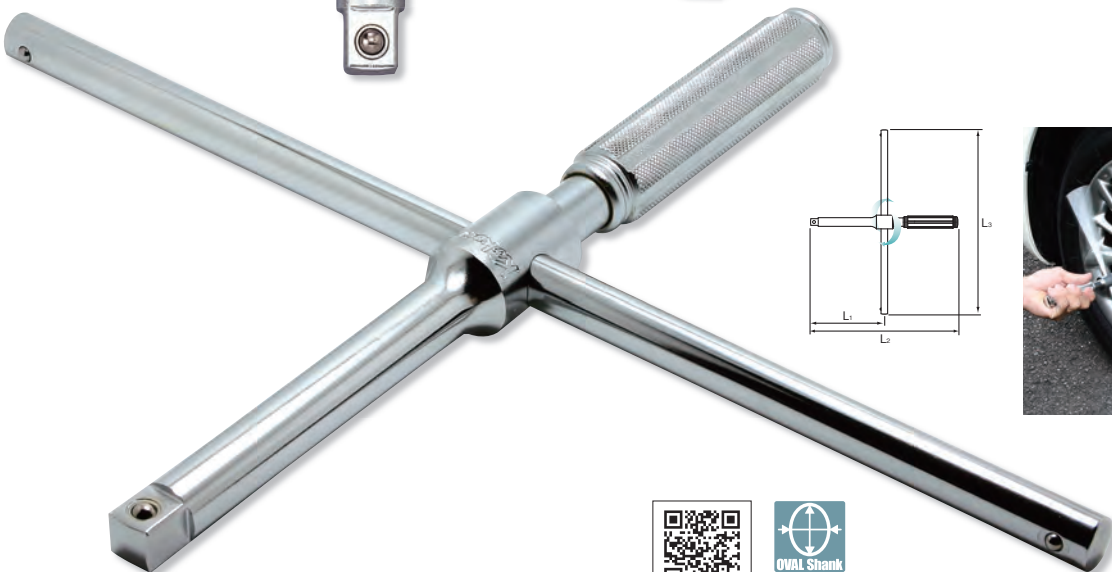

		L ₁ (mm)	L ₂ (mm)	 (g)	 (pce.)
4715		267	255	475	1
4715S		267	170	402	1
4715SL		250	250	640	1

4711X  Spinning Cross Wrench





FREE-TURN
CROSS WRENCH



		L ₁ (mm)	L ₂ (mm)	L ₃ (mm)	 (g)	 (pce.)
4711X		140	280	350	945	1

3131E		D ₁ (mm)	D ₂ (mm)	L (mm)	(g)	(pcs.)
New	□ 2.1 x ø2.8	6.8	18	40	45	10
New	□ 2.7 x ø3.5	8	18	40	46	10
New	□ 3.4 x ø4.5	9.5	18	40	47	10
New	□ 4.9 x ø6	11.5	18	40	48	10
New	□ 6.5 x ø7	12.5	18	40	49	10
New	□ 7 x ø9	15	18	40	48	10
New	□ 9 x ø11	17	18	40	48	10
New	□ 9 x ø12	18	18	40	48	10

For DIN352, DIN351, DIN2181, DIN5157 tap

3264		10 Pieces Set/△=1.050g		
Sockets		Accessories		
	3131E		160K	
	□ 2.1xø2.8, □ 2.7xø3.5,			3760-125
	□ 3.4xø4.5, □ 4.9xø6,			
	□ 6.5xø7, □ 7xø9,			
	□ 9xø11, □ 9xø12,			

3131A	□	S(mm)		L (mm)	(g)	(pcs.)
		Min.	Max.			
1	□ 3/8"	2.0	5.0	42	80	5
2	□ 3/8"	4.5	8.0	47	100	5

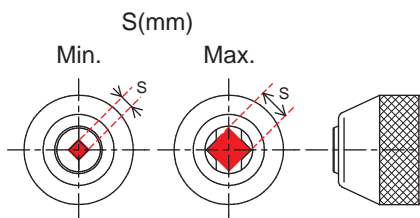

Tap is not included.

	□	C (mm)	L (mm)	(g)	(pcs.)
160K	□ 3/8"	10	220	130	1
160K-1/2	□ 1/2"	10	220	135	1

	□	D (mm)	H ₁ (mm)	H ₂ (mm)	d (mm)	A (mm)	L (mm)	(g)	(pcs.)
3132-20	□ 3/8"	28	7	17	8	45	60	130	5
4132-25		34	9	22	14	40	60	170	2
4132-38	□ 1/2"	48	13	24	18	60	80	315	2
4132-50		60	16	27	30	85	105	740	2



Die is not included.



3131E Tap Holder Adaptadores para machos de terrajas

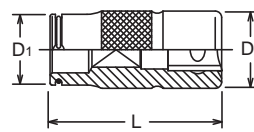

3264 Tap Holder, Set Juego de adaptadores para machos de terrajas



3131A Tap Holder, Adjustable Adaptadores para machos de terrajas

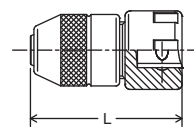

160K Handle Llave

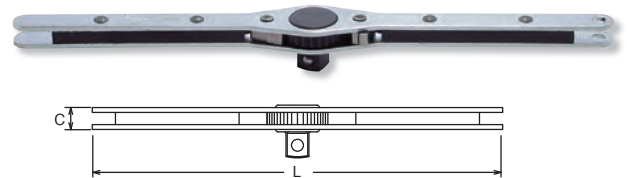

3132 Die Holders Adaptadores

4132

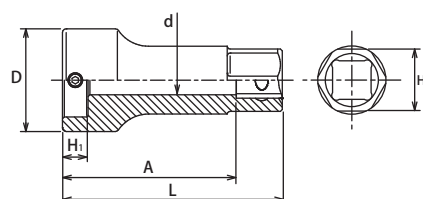



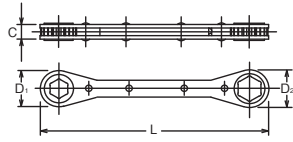

Ratcheting Ring Wrench

Z-SERIES
HAND
MANUALES
TITANIUM
DE TITANIO
ACCESSORIES
ACCESORIOS
SCREWDRIVERS
DESTORNILLADORES
IMPACT
DE IMPACTO
SLEEVE-DRIVE
INDUSTRIAL
INDUSTRIALES
PROTECTOR
PROTECTORES
AUTOMOTIVE
CONSTRUCTION
CONSTRUCCIÓN
RENEWAL KITS
JUEGOS DE PIEZAS REPUESTO

102NM • 102NA Without Reverse Lever Sin palanca de inversión





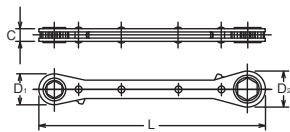

102NM (mm)	L (mm)	D ₁ (mm)	D ₂ (mm)	C (mm)	 (g)	 (pcs.)
6x7	108	15.3	16.4	7.5	60	10
7x8	108	15.3	16.4	7.5	60	10
8x9	134	17.1	19.7	7.5	80	10
8x10	134	17.1	19.7	7.5	80	10
10x11	140	20.1	22.7	7.5	87	10
10x12	140	20.1	22.7	7.5	87	10
11x13	145	23.6	24.6	9	112	10
12x13	145	23.6	24.6	9	112	10
12x14	145	23.6	24.6	9	112	10

102NA (inch)	L (mm)	D ₁ (mm)	D ₂ (mm)	C (mm)	 (g)	 (pcs.)
7/32x 1/4	108	15.3	16.4	7.5	60	10
1/4 x 9/32	108	15.3	16.4	7.5	60	10
1/4 x 5/16	108	15.3	16.4	7.5	60	10
5/16x11/32	134	17.1	19.7	7.5	80	10
5/16x 3/8	134	17.1	19.7	7.5	80	10
3/8 x 7/16	140	20.1	22.7	7.5	87	10
7/16x 1/2	145	23.6	24.6	9	112	10
1/2 x 9/16	145	23.6	24.6	9	112	5

102KM • 102KA Reversible Reversible





102KM (mm)	L (mm)	D ₁ (mm)	D ₂ (mm)	C (mm)	 (g)	 (pcs.)
6x7	108	15.3	16.4	7.2	51	10
7x8	108	15.3	16.4	7.2	51	10
8x9	134	17	20	9.1	76	10
8x10	134	17	20	9.1	76	10
10x11	141	21	23.5	9.1	84	10
10x12	141	21	23.5	9.1	84	10
12x13	146	24	25	9.1	89	10
12x14	146	24	25	9.1	89	5
13x17	200	27.1	31.8	11.5	190	5
14x17	200	27.1	31.8	11.5	200	5

102KA (inch)	L (mm)	D ₁ (mm)	D ₂ (mm)	C (mm)	 (g)	 (pcs.)
7/32x 1/4	108	15.3	16.4	7.2	51	10
1/4 x 5/16	108	15.3	16.4	7.2	51	10
5/16x11/32	134	17	20	9	76	10
3/8 x 7/16	141	21	23.5	9.1	84	10
1/2 x 9/16	146	24	25	9.1	89	5

102KM.BH With Twin Openings (Two-in-One) Con Bocas Gemelas (Dos en Uno)



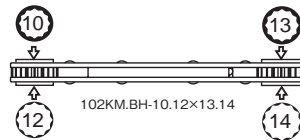

102KM.BH (mm)	L (mm)	D ₁ (mm)	D ₂ (mm)	C (mm)	 (g)	 (pcs.)
5.5 • 6x 7 • 8	108	15.3	16.4	10	60	10
8 • 10x12•13	141	21	23.5	13	87	10
9 • 10x11•12	141	21	23.5	13	87	10
10 • 12x13•14	146	24	25	13	98	10
13 • 14x15•17	200	27.1	31.8	16	200	5



102KT Reversible TORX® Reversible TORX®



102KT (E)	L (mm)	D ₁ (mm)	D ₂ (mm)	C (mm)	 (g)	 (pcs.)
E 4xE 6	108	15.3	16.4	7.5	51	10
E 6xE 8	108	15.3	16.4	7.5	51	10
E10xE12	134	17	20	9	76	10

103KM (mm)	L (mm)	D ₁ (mm)	D ₂ (mm)	C (mm)	(g)	(pcs.)
6x 7	108	15.3	16.4	7.5	51	5
7x 8	108	15.3	16.4	7.5	51	5
8x 9	134	17	20	9	76	5
8x10	134	17	20	9	76	5
10x11	140	21	23.5	9	84	5
10x12	140	21	23.5	9	84	5
12x13	145	24	25	9	89	5
12x14	145	24	25	9	89	5

103KA (inch)	L (mm)	D ₁ (mm)	D ₂ (mm)	C (mm)	(g)	(pcs.)
7/32x 1/4	108	15.3	16.4	7.5	51	5
1/4 x 5/16	108	15.3	16.4	7.5	51	5
5/16x11/32	134	17	20	9	76	5
5/16x 3/8	134	17	20	9	76	5
3/8 x 7/16	140	21	23.5	9	84	5
7/16x 1/2	145	24	25	9	89	5
1/2 x 9/16	145	24	25	9	89	5

103KA.BH (inch)	L (mm)	D ₁ (mm)	D ₂ (mm)	C (mm)	(g)	(pcs.)
1/4x5/16	108	15.3	16.4	7.5	51	5
3/8x7/16	140	21	23.5	9	84	5
1/2x9/16	145	24	25	9	89	5

103KT (E)	L (mm)	D ₁ (mm)	D ₂ (mm)	C (mm)	(g)	(pcs.)
E 4xE 6	104	15.3	16.4	7.5	51	5
E 6xE 8	104	15.3	16.4	7.5	51	5
E10xE12	128	17	20	9	76	5
E14xE16	139	24	25	9	89	5

R810 (inch)	L (mm)	D ₁ (mm)	D ₂ (mm)	C (mm)	(g)	(pcs.)
1/4x5/16	108	15.3	16.4	7.5	60	10
3/8x7/16	140	20.1	22.7	7.5	87	10
1/2x9/16	145	23.6	24.6	9	112	10

**103KM · 103KA
103KA.BH**

- Reversible
- Reversible
- Reversible(12P)
- Reversible(12P)

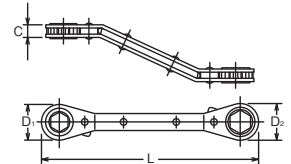

103KT

- Reversible TORX®
- Reversible TORX®

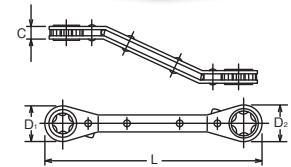

R810

- Reversible
- Reversible



154M

- Push and Pull-Ratchets
- Llaves de Carraca de Empuje y Tracción

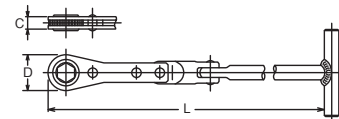

154M (mm)	L (mm)	D (mm)	C (mm)	(g)	(pcs.)
8	294	17.1	7.5	178	2
10	297	20.1	7.5	183	2
12	300	23.6	9	189	2
13	301	24.6	9	194	2
14	301	24.6	9	194	2



154ML

- Push and Pull-Ratchets
- Llaves de Carraca de Empuje y Tracción

154ML (mm)	L (mm)	D (mm)	C (mm)	(g)	(pcs.)
10	297	20.1	7.5	230	2
12	300	23.6	9	252	2

Ratcheting Ring Wrench

Z-SERIES
HAND MANUALES
TITANIUM DE TITANIO
ACCESSORIES ACCESORIOS
SCREWDRIVERS DESTORNILLADORES
IMPACT DE IMPACTO
SLEEVE-DRIVE
INDUSTRIAL INDUSTRIALES
PROTECTOR PROTECTORES
AUTOMOTIVE
CONSTRUCTION CONSTRUCCIÓN
RENEWAL KITS JUEGOS DE PIEZAS REPUÉS

137  For 1/4" and 3/8" Square Drive Sockets
Para Vasos con Conductor Cuadrado de 1/4" y 3/8"

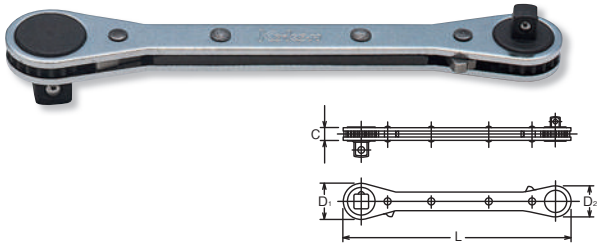

	L (mm)	D ₁ (mm)	D ₂ (mm)	C (mm)	(g)	(pcs.)
137	141	23.5	21	9	104	5

1/4" x 3/8"

138   For Bits 101
Para Puntas 101

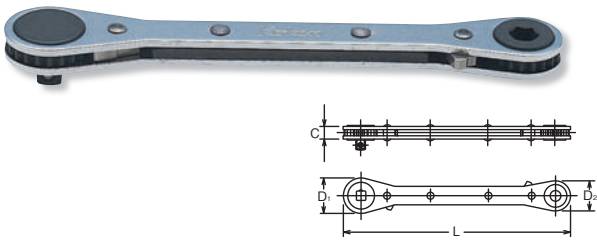

	L (mm)	D ₁ (mm)	D ₂ (mm)	C (mm)	(g)	(pcs.)
138	141	23.5	21	9	97	10

1/4" x 1/4"

139  For 1/4" Square Drive Sockets
Para Vasos con Conductor Cuadrado de 1/4"

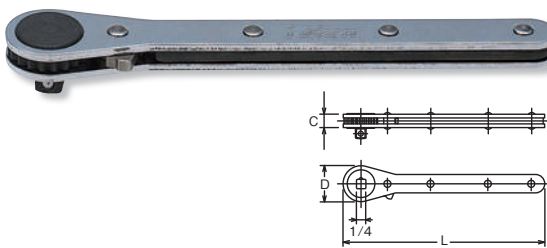

	L (mm)	D (mm)	C (mm)	(g)	(pcs.)
139	125	20.1	7.5	80	10

1/4"

145KM-10H  Reversible, 10mm 6-point
Reversible, 10mm Hexagonal

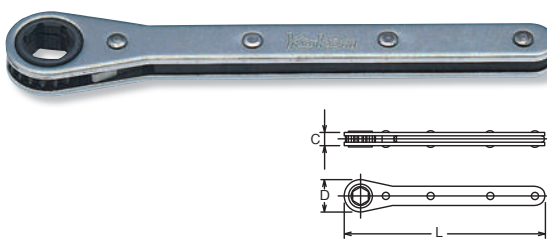

145KM (mm)	L (mm)	D (mm)	C (mm)	(g)	(pcs.)
10H	125	20.1	7.5	72	10



145KM-10H+150.10H-8 2753N+2400M-8

150-10H  Sockets with 10mm 6-point Drive End
Vasos con Conductor Hexagonal 10mm



150.10H (mm)	D (mm)	H (mm)	L (mm)	(g)	(pcs.)
5	12	3.5	11	6	10
6	12	4.5	12.5	7	10
7	12	5	14	7	10
8	12	6	15.5	7	10
9	13	6	16	7	10
10	14.3	7	17	9	10
12	17.4	9	19.5	14	10



1203  Sockets with 10mm 6-point Drive End in Set with Ratchet
Juego de Vasos con Conductor Hex con Llave de Carraca







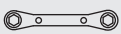



1203 7 Pieces Set  =250g







METAL CASE: W130xH65xT20mm



Sockets	Accessory
 150.10H 5, 6, 7, 8, 9, 10	145KM-10H

R810A		5 Pieces Set/📦=208g	
METAL CASE:W130xH65xT20mm			
Bits	Accessory		
 101P Phillips Bits 1, 2, 3		102NA-1/4x5/16	
 101S Slotted Bit 1x7			

R810B		10 Pieces Set/📦=268g	
METAL CASE:W130xH65xT20mm			
Bits	Accessory		
 101P Phillips Bits 1, 2, 3		102NA-1/4x5/16	
 101S Slotted Bit 1x7			
 128H Hex Bits 3, 4, 5, 6, 8			

R810C		12 Pieces Set/📦=227g	
METAL CASE:W130xH65xT20mm			
Bits, Sockets	Accessories		
 101P Phillips Bits 1, 2, 3		102NA-1/4x5/16	
 101S Slotted Bit 1x7			
 2400M Sockets 5, 6, 7, 8, 9, 10		101A	

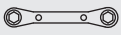
R810D		17 Pieces Set/📦=336g	
METAL CASE:W130xH65xT20mm			
Bits, Sockets	Accessories		
 101P Phillips Bits 1, 2, 3		102NA-1/4x5/16	
 101S Slotted Bit 1x7			
 128H Hex Bits 3, 4, 5, 6, 8		101A	
 2400M Sockets 5, 6, 7, 8, 9, 10			

R810E		9 Pieces Set/📦=445g	
METAL CASE:W130xH65xT20mm			
Sockets	Accessories		
 2300M Deep Sockets 6, 7, 8, 9, 10, 11, 12		102NA-1/4x5/16	
		101A	



R810A Bit Set
Juego de Puntas



R810B Bit Set
Juego de Puntas



R810C Bit and Socket Set
Juego de Puntas y Vasos



R810D Bit and Socket Set
Juego de Puntas y Vasos



R810E Socket Set
Juego de Vasos



Z-SERIES
HAND
MANUALES
TITANIUM
DE TITANIO
ACCESSORIES
ACCESORIOS
SCREWDRIVERS
DESTORNILLADORES
DE IMPACTO
IMPACT
SLEEVE-DRIVE
SLEEVES-DRIVE
INDUSTRIAL
INDUSTRIALES
PROTECTOR
PROTECTORES
AUTOMOTIVE
CONSTRUCTION
CONSTRUCCION
RENEWAL KITS
JUEGOS DE PIEZAS/REUESTO

Ratcheting Ring Wrench

Z-SERIES

HAND
MANUALES

TITANIUM
DE TITANIO

ACCESSORIES
ACCESORIOS

SCREWDRIVERS
DESTORNILLADORES

IMPACT
DE IMPACTO

SLEEVE-DRIVE

INDUSTRIAL
INDUSTRIALES

PROTECTOR
PROTECTORES

AUTOMOTIVE

CONSTRUCTION
CONSTRUCCIÓN

RENEWAL KITS
JUEGOS DE PIEZAS REPUESTO

101P Phillips Bits Puntas Phillips

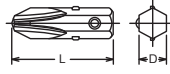

101P (PH)	D (mm)	L (mm)	(g)	(pcs.)
1	6.35	20.5	3	10
2	6.35	20.5	4	10
3	6.35	20.5	5	10

101S Bits for Slotted Head Puntas Rectas/Planas

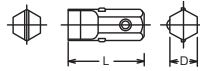

101S	D (mm)	L (mm)	(g)	(pcs.)
1.0x7	6.35	15	3	10
1.2x7	6.35	15	3	10

101H Hex Bits Puntas Hexagonales

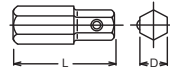

101H (mm)	D (mm)	L (mm)	(g)	(pcs.)
3	6.35	20.5	5	10
4	6.35	20.5	5	10
5	6.35	20.5	5	10
6	6.35	20.5	5	10
7	6.35	20.5	6	10
8	6.35	20.5	7	10

101B Ball point Hex Bits Puntas Hexagonales con bola

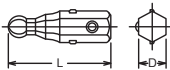

101B (mm)	D (mm)	L (mm)	(g)	(pcs.)
3	6.35	25	4	10
4	6.35	25	4	10
5	6.35	25	5	10
6	6.35	25	5	10

 Ball point bits have less strength due to the special design. Make sure to use them correctly.

101T (T) TORX® Bits Puntas TORX®

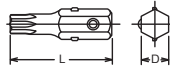

101T (T)	D (mm)	L (mm)	(g)	(pcs.)
T 9	6.35	25	4	10
T10	6.35	25	4	10
T15	6.35	25	5	10
T20	6.35	25	5	10
T25	6.35	25	5	10
T27	6.35	25	6	10
T30	6.35	25	6	10

101T (TH) Tamper-Resistant TORX® Bits Punta TORX®, indeformable

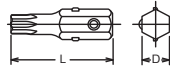

101T (TH)	D (mm)	L (mm)	(g)	(pcs.)
T10H	6.35	25	4	10
T15H	6.35	25	4	10
T20H	6.35	25	5	10
T25H	6.35	25	5	10
T27H	6.35	25	6	10
T30H	6.35	25	6	10





 Tamper Resistant TORX® Bits have less strength due to special design. Make sure to use it correctly.

128H (mm)	D (mm)	L (mm)	(g)	(pcs.)
3	8	32	11	10
4	8	32	11	10
5	8	32	12	10
6	8	32	12	10
8	8	32	13	10

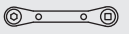
128T (T)	D (mm)	L (mm)	(g)	(pcs.)
T10	8	32	9	10
T15	8	32	9	10
T20	8	32	9	10
T25	8	32	10	10
T27	8	32	10	10
T30	8	32	11	10

101A	D (mm)	S (mm)	L (mm)	(g)	(pcs.)
	8	6.35	20	8	10

1202		15 Pieces Set/ 420g
METAL CASE: W190xH60xT30mm		
Bits	Accessory	
<ul style="list-style-type: none"> 101P Phillips Bits 1, 2, 3 101S Slotted Bit 1x7 101B Ballpoint Hex Bits 3, 4, 5, 6 101T Torx® Bits T10, T15, T20, T25, T27, T30 	 138	

2254M		12 Pieces Set/ 450g
METAL CASE: W160xH100xT28mm		
Bits	Accessories	
<ul style="list-style-type: none"> 101P Phillips Bits 1, 2, 3 101S Slotted Bits 1x7, 1.2x7 101H Hex Bits 3, 4, 5 	<ul style="list-style-type: none">  102NA-1/4x5/16  2769F  101A  2137 	

128H Hex Bits Puntas Hexagonales

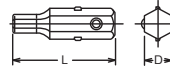

128T TORX® Bits Puntas TORX®

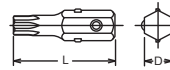

101A Adaptor Adaptador

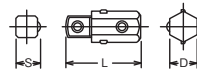

1202 Bit Set Juego de Puntas



2254M Bit Set Juego de Puntas



Z-SERIES
HAND
MANUALES
TITANIUM
DE TITANIO
ACCESSORIES
ACCESORIOS
SCREWDRIVERS
DESTORNILLADORES
IMPACT
DE IMPACTO
SLEEVE-DRIVE
INDUSTRIAL
INDUSTRIALES
PROTECTOR
PROTECTORES
AUTOMOTIVE
CONSTRUCTION
CONSTRUCCION
RENEWAL KITS
JUEGOS DE PIEZAS/REPOSTO

ATTACK DRIVER®

Z-SERIES
HAND
MANUALES
TITANIUM
DE TITANIO
ACCESSORIES
ACCESORIOS
SCREWDRIVERS
DESTORNILLADORES
IMPACT
DE IMPACTO
SLEEVE-DRIVE
INDUSTRIAL
INDUSTRIALES
PROTECTOR
PROTECTORES
AUTOMOTIVE
CONSTRUCTION
CONSTRUCCIÓN
RENEWAL KITS
JUEGOS DE PIEZAS REPUES TO

3112N Attack Driver
Destornillador de Impacto



	□	L (mm)	(g)	(pce.)
3112N	3/8"	159	730	1
3112G		159	810	1

* Renewal Kits → 3112RK → P306

3112G Attack Driver
Destornillador de Impacto



	□	L (mm)	(g)	(pce.)
4112N	1/2"	163	730	1
4112G		163	810	1

* Renewal Kits → 4112RK → P306

4112N Attack Driver
Destornillador de Impacto



	□	L (mm)	(g)	(pce.)
6112	3/4"	190	1900	1

* Renewal Kits → 6112RK → P306



Black finished head prevents peeling off the chrome plate by striking the head.

4112G Attack Driver
Destornillador de Impacto



6112 Attack Driver
Destornillador de Impacto

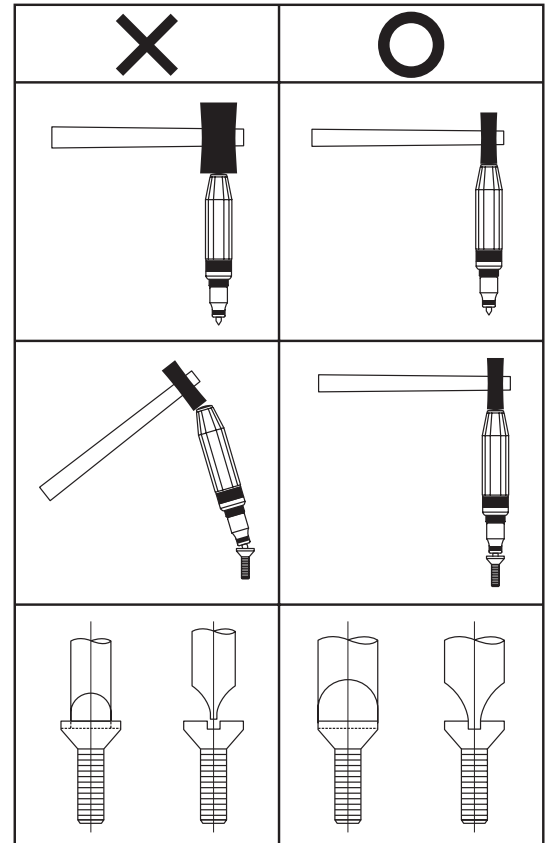

AN318A 6 Pieces Set/△=1,070g
METAL CASE:W190xH59xT45mm

Bits	Accessories
100P.32 Phillips Bits 2, 3	3112N
100S.32 Slotted Bits 9, 11	3138

AN112A 6 Pieces Set/△=1,070g
METAL CASE:W190xH59xT45mm

Bits	Accessories
100P.32 Phillips Bits 2, 3	4112N
100S.32 Slotted Bits 9, 11	4138

100P, S Bits → P166

AG318A 6 Pieces Set/△=1,150g
METAL CASE:W220xH82xT60mm

Bits	Accessories
100P.32 Phillips Bits 2, 3	3112G
100S.32 Slotted Bits 9, 11	3138

AG112A 6 Pieces Set/△=1,150g
METAL CASE:W220xH82xT60mm

Bits	Accessories
100P.32 Phillips Bits 2, 3	4112G
100S.32 Slotted Bits 9, 11	4138

100P, S Bits → P166

AN112C 8 Pieces Set/△=1,350g
METAL CASE:W220xH82xT60mm

Bits	Accessories
100P.80 Phillips Bits 1, 2, 3	4112N
100S.80 Slotted Bits 7, 9, 12	4138

100P, S Bits → P166

AG112F 25 Pieces Set/△=1,530g
METAL CASE:W220xH82xT60mm

Bits	Accessories
100P.32 Phillips Bits 2, 3	4112G
100P.32 PZ Bits PZ2, PZ3	4138
100S.32 Slotted Bits 9, 11	
100H.32 Hex Bits 4, 5, 6, 7, 8, 10	
100T.32 TORX® Bits T25, T27, T30, T40, T45, T50	
100X.32 XZN Bits M5, M6, M8, M10, M12	

100P, S, H, T, X Bits → P166

AG112H 18 Pieces Set/△=1,480g
METAL CASE:W220xH82xT60mm

Bits	Accessories
100P.32 Phillips Bits 2, 3, 4	4112G
100S.32 Slotted Bits 8, 9, 10, 12, 14	4138
100H.32 Hex Bits 5, 6, 8, 10	
100T.32 TORX® Bits T30, T40, T45, T50	

100P, S, H, T Bits → P166

AN318A Attack Driver Set
Juego de Destornilladores de Impacto
AN112A



AG318A Attack Driver Set
Juego de Destornilladores de Impacto
AG112A



AN112C Attack Driver Set
Juego de Destornilladores de Impacto



AG112F Attack Driver Set
Juego de Destornilladores de Impacto



AG112H Attack Driver Set
Juego de Destornilladores de Impacto



Z-SERIES
HAND
MANUALES
TITANIUM
DE TITANIO
ACCESSORIES
ACCESORIOS
SCREWDRIVERS
DESTORNILLADORES
IMPACT
DE IMPACTO
SLEEVE-DRIVE
INDUSTRIAL
INDUSTRIALES
PROTECTOR
PROTECTORES
AUTOMOTIVE
CONSTRUCTION
JUEGOS DE PIEZAS REPUSTO
CONSTRUCCIÓN
RENEWAL KITS
JUEGOS DE PIEZAS REPUSTO
CONSTRUCCIÓN

108P-25 · -32 · -50  Phillips Bits
Puntas Phillips

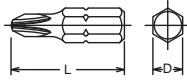

108S-25 · -39  Bits for Slotted head
Puntas Rectas/Planas

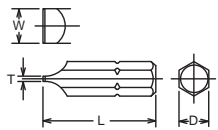

108H-25  Hex Bits
Puntas Hexagonales

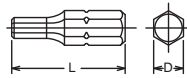

108T-25 (T)  TORX® Bits
Puntas TORX®

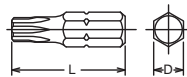

108T-25 (TH)  Tamper-Resistant TORX® Bits
Punta TORX®, indeformable 

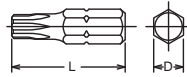

 Tamper Resistant TORX® Bits have less strength due to special design.
Make sure to use it correctly.

108A  Adaptor
Adaptador

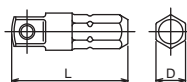

108P.25 (PH)	D (mm)	L (mm)	(g)	(pcs.)
1	6.35	25	5	10
2	6.35	25	5	10
3	6.35	25	6	10

108P.32 (PH)	D (mm)	L (mm)	(g)	(pcs.)
1	6.35	32	7	10
2	6.35	32	7	10
3	6.35	32	8	10

108P.50 (PH)	D (mm)	L (mm)	(g)	(pcs.)
1	6.35	50	10	10
2	6.35	50	11	10
3	6.35	50	11	10

108S.25	TxW (mm)	D (mm)	L (mm)	(g)	(pcs.)
3	0.5x3	6.35	25	3	10
4	0.6x4	6.35	25	3	10
4.5	0.6x4.5	6.35	25	4	10
5	0.8x5	6.35	25	5	10
5.5	0.8x5.5	6.35	25	5	10
6	1.0x6	6.35	25	5	10
8	1.2x8	6.35	25	6	10

108S.39	TxW (mm)	D (mm)	L (mm)	(g)	(pcs.)
3	0.5x3	6.35	39	6	10
4	0.6x4	6.35	39	6	10
4.5	0.6x4.5	6.35	39	6	10
5	0.8x5	6.35	39	7	10
5.5	0.8x5.5	6.35	39	8	10
6	1.0x6	6.35	39	9	10
8	1.2x8	6.35	39	12	10

108H.25 (mm)	D (mm)	L (mm)	(g)	(pcs.)
3	6.35	25	4	10
4	6.35	25	5	10
5	6.35	25	5	10
6	6.35	25	6	10
7	6.35	25	7	10
8	6.35	25	8	10
10	6.35	25	11	10

108H.25 (inch)	D (mm)	L (mm)	(g)	(pcs.)
1/8	6.35	25	4	10
9/64	6.35	25	5	10
5/32	6.35	25	5	10
3/16	6.35	25	5	10
7/32	6.35	25	6	10
1/4	6.35	25	7	10

108T.25 (T)	D (mm)	L (mm)	(g)	(pcs.)
T 8	6.35	25	4	10
T10	6.35	25	4	10
T15	6.35	25	4	10
T20	6.35	25	5	10
T25	6.35	25	6	10
T27	6.35	25	6	10
T30	6.35	25	6	10
T40	6.35	25	6	10

108T.25 (TH)	D (mm)	L (mm)	(g)	(pcs.)
T10H	6.35	25	4	10
T15H	6.35	25	4	10
T20H	6.35	25	5	10
T25H	6.35	25	6	10
T27H	6.35	25	6	10
T30H	6.35	25	6	10
T40H	6.35	25	6	10

108A.25	D (mm)	L (mm)	(g)	(pcs.)
1/4B	6.35	25	10	10

	□	D ₁ (mm)	D ₂ (mm)	L (mm)	⚖ (g)	◇ (pcs.)
2137	1/4"	12	12	22.5	13	10
3137	3/8"	13	16.5	30	30	10
4137	1/2"	13	22	38	53	10

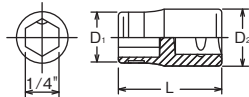
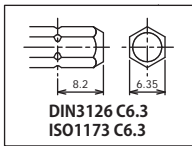

2137 ○ Bit Holder
Porta-punta



3137 ○ Bit Holder
Porta-punta



4137 ○ Bit Holder
Porta-punta



12139 ○ Impact Bit Holder
Porta-punta de Impacto



13139 ○ Impact Bit Holder
Porta-punta de Impacto



14139 ○ Impact Bit Holder
Porta-punta de Impacto



	□	D ₁ (mm)	D ₂ (mm)	L (mm)	⚖ (g)	◇ (pcs.)	⚡
12139-1/4	1/4"	11	13	25	15	10	*1
13139-1/4	3/8"	11	19	30	32	10	*2
14139-1/4	1/2"	11	25	35	62	10	*3

*1 Pin/O-Ring=1200A/B

*2 C-Ring=1301C, Pin/O-Ring=1301A/B

*3 C-Ring=1401C, Pin/O-Ring=1401A/B

→ P254-255

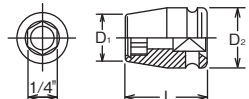
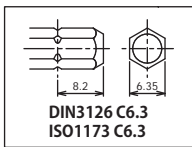

13142-D6.3 ○ Impact Bit Holder for 1/4" (6.3) Bits
Porta-punta de Impacto para Puntas 1/4" (6.3) ⚠

14142-D6.3 ○



	□	D ₁ (mm)	D ₂ (mm)	L (mm)	⚖ (g)	◇ (pcs.)	⚡
13142-D6.3	3/8"	16	19	45	60	10	*1
14142-D6.3	1/2"	16	25	55	97	10	*2

*1 C-Ring=1301C, Pin/O-Ring=1301A/B

*2 C-Ring=1401C, Pin/O-Ring=1401A/B

→ P254-255

Lock & Quick Release

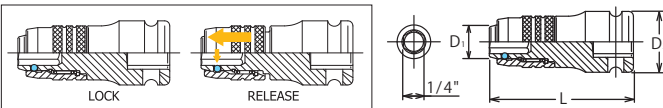

⚠ You may not hold the sliding part while moving to avoid heating up by friction and reduction by wear.

	D (mm)	H (mm)	L (mm)	⚖ (g)	◇ (pcs.)
2749P-1/4HF	25	12	125	96	10
2774P-1/4HF	25	12	165	133	2

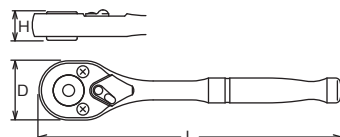
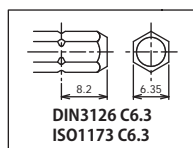

2749P-1/4HF ○ Reversible Ratchet, for Bits 1/4"
Llave de Carraca Reversible, para Puntas 1/4"



2774P-1/4HF ○ Flexible Ratchet, Reversible, for Bits 1/4"
Llave de Carraca Reversible, para Puntas 1/4"



Z-SERIES
HAND
MANUALES
TITANIUM
DE TITANIO
ACCESSORIES
ACCESORIOS
SCREWDRIVERS
DESTORNILLADORES
IMPACT
DE IMPACTO
SLEEVE-DRIVE
INDUSTRIAL
INDUSTRIALES
PROTECTOR
PROTECTORES
AUTOMOTIVE
CONSTRUCTION
CONSTRUCCION
RENEWAL KITS
JUEGOS DE PIEZAS/REPUESTO

100P-32 · -80 · -125 Phillips Bits Puntas Phillips



100P.32 (PH)	D (mm)	L (mm)	(g)	(pcs.)
1	8	32	11	10
2	8	32	11	10
3	8	32	12	10
4	8	32	12	10

100P-32 (PZ) PZ Bits Puntas PZ



100S-32 · -80 Bits for Slotted Head Puntas Rectas/Planas

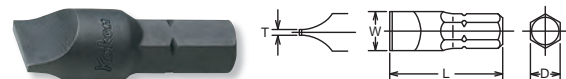

100S.32	TxW (mm)	D (mm)	L (mm)	(g)	(pcs.)
6	1 x 6	8	32	10	10
7	1 x 7	8	32	11	10
8	1.2x 8	8	32	12	10
9	1.6x 9	8	32	12	10
10	1.6x10	8	32	13	10
11	1.6x11	8	32	15	10
12	2 x12	8	32	18	10
14	2 x14	8	32	21	10

100H-32 Hex Bits Puntas Hexagonales



100T-32 (T) TORX® Bits Puntas TORX®

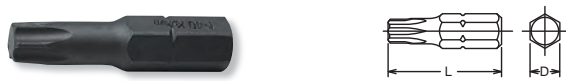

100T-32 (TH) Tamper-Resistant TORX® Bits Punta TORX®, indeformable



 Tamper Resistant TORX® Bits have less strength due to special design. Make sure to use it correctly.

100X-32 (XZN) XZN Bits Puntas XZN

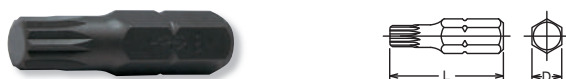

100P.80 (PH)	D (mm)	L (mm)	(g)	(pcs.)
1	8	80	30	10
2	8	80	30	10
3	8	80	31	10
4	8	80	32	10

100P.125 (PH)	D (mm)	L (mm)	(g)	(pcs.)
2	8	125	48	10
3	8	125	49	10

100P.32 (PZ)	D (mm)	L (mm)	(g)	(pcs.)
PZ2	8	32	10	10
PZ3	8	32	11	10

100S.80	TxW (mm)	D (mm)	L (mm)	(g)	(pcs.)
6	1 x 6	8	80	29	10
7	1 x 7	8	80	30	10
8	1.2x 8	8	80	31	10
9	1.6x 9	8	80	32	10
10	1.6x10	8	80	33	10
11	1.6x11	8	80	33	10
12	2 x12	8	80	34	10
14	2 x14	8	80	37	10

100H.32 (mm)	D (mm)	L (mm)	(g)	(pcs.)
3	8	32	11	10
4	8	32	11	10
5	8	32	12	10
6	8	32	12	10
7	8	32	13	10
8	8	32	13	10
9	8	32	16	10
10	8	32	16	10
11	8	32	20	10
12	8	32	23	10
14	8	32	29	10

100T.32 (T)	D (mm)	L (mm)	(g)	(pcs.)
T10	8	32	9	10
T15	8	32	9	10
T20	8	32	9	10
T25	8	32	10	10
T27	8	32	10	10
T30	8	32	11	10
T40	8	32	12	10
T45	8	32	12	10
T50	8	32	12	10
T55	8	32	12	10

100T.32 (TH)	D (mm)	L (mm)	(g)	(pcs.)
T10H	8	32	9	10
T15H	8	32	9	10
T20H	8	32	9	10
T25H	8	32	10	10
T27H	8	32	10	10
T30H	8	32	11	10
T40H	8	32	12	10
T45H	8	32	12	10
T50H	8	32	12	10
T55H	8	32	12	10

100X.32 (XZN)	D (mm)	L (mm)	(g)	(pcs.)
M 5	8	32	10	10
M 6	8	32	11	10
M 8	8	32	12	10
M10	8	32	16	10
M12	8	32	19	10

	□	D ₁ (mm)	D ₂ (mm)	L (mm)	(g)	(pcs.)
2138	1/4"	16	16	26	32	10
3138	3/8"	16	18	38	55	10
4138	1/2"	16	22	38	62	10

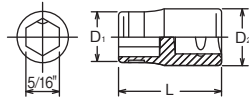
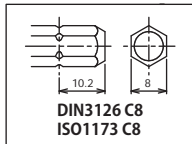

2138 ○ Bit Holder
Porta-punta



3138 ○ Bit Holder
Porta-punta



4138 ○ Bit Holder
Porta-punta



	□	D ₁ (mm)	D ₂ (mm)	L (mm)	(g)	(pcs.)	⊖
12140-5/16	1/4"	14	13	25	15	10	*1
13140-5/16	3/8"	14	19	30	32	10	*2
14140-5/16	1/2"	14	25	35	62	10	*3

*1 Pin/O-Ring=1200A/B

*2 C-Ring=1301C, Pin/O-Ring=1301A/B

*3 C-Ring=1401C, Pin/O-Ring=1401A/B → P254-255

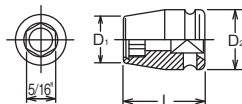
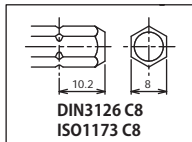

12140 ○ Impact Bit Holder
Porta-punta de Impacto



13140 ○ Impact Bit Holder
Porta-punta de Impacto



14140 ○ Impact Bit Holder
Porta-punta de Impacto



	D (mm)	H (mm)	L (mm)	(g)	(pcs.)
2749P-5/16HF	25	14	125	96	10
2774P-5/16HF	25	14	165	133	2

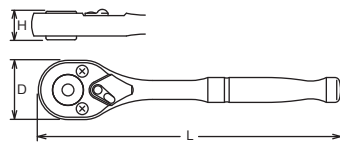
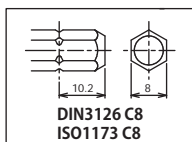

2749P-5/16HF ○ Reversible Ratchet, for Bits 5/16"
Llave de Carraca Reversible, para Puntas 5/16"



2774P-5/16HF ○ Flexible Ratchet, reversible, for Bits 5/16"
Llave de Carraca Reversible, para Puntas 5/16"



121P-50 · -70 · -100 · -150 Phillips Bits Puntas Phillips

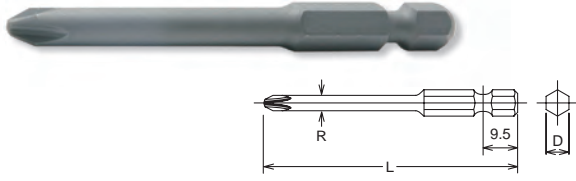

121P.50 (PH)	D (mm)	R (mm)	L (mm)	(g)	(pcs.)
1	6.35	4.5	50	12	10
2	6.35	5.5	50	12	10
3	6.35	-	50	13	10

121H-50 · -70 · -100 · -150 Hex Bits Puntas Hexagonales

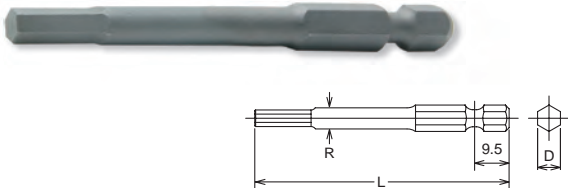

121H.50 (mm)	D (mm)	R (mm)	L (mm)	(g)	(pcs.)
2	6.35	3	50	11	10
2.5	6.35	3	50	12	10
3	6.35	3.5	50	12	10
4	6.35	4.5	50	12	10
5	6.35	5.6	50	13	10
6	6.35	-	50	14	10

121T-50 · -70 · -100 · -150 (T) TORX® Bits Puntas TORX®

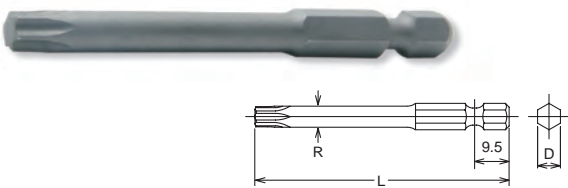

121T.50 (T)	D (mm)	R (mm)	L (mm)	(g)	(pcs.)
T10	6.35	3	50	12	10
T15	6.35	3.5	50	12	10
T20	6.35	4.1	50	12	10
T25	6.35	4.6	50	12	10
T27	6.35	5.2	50	13	10
T30	6.35	5.7	50	13	10
T40	6.35	-	50	14	10

121P.70 (PH)	D (mm)	R (mm)	L (mm)	(g)	(pcs.)
1	6.35	4.5	70	15	10
2	6.35	5.5	70	15	10
3	6.35	-	70	16	10

121P.100 (PH)	D (mm)	R (mm)	L (mm)	(g)	(pcs.)
1	6.35	4.5	100	23	10
2	6.35	5.5	100	23	10
3	6.35	-	100	24	10

121P.150 (PH)	D (mm)	R (mm)	L (mm)	(g)	(pcs.)
1	6.35	4.5	150	30	10
2	6.35	5.5	150	35	10
3	6.35	-	150	36	10

121H.70 (mm)	D (mm)	R (mm)	L (mm)	(g)	(pcs.)
2	6.35	3	70	13	10
2.5	6.35	3	70	15	10
3	6.35	3.5	70	15	10
4	6.35	4.5	70	15	10
5	6.35	5.6	70	16	10
6	6.35	-	70	18	10

121H.100 (mm)	D (mm)	R (mm)	L (mm)	(g)	(pcs.)
2	6.35	3	100	22	10
2.5	6.35	3	100	23	10
3	6.35	3.5	100	23	10
4	6.35	4.5	100	23	10
5	6.35	5.6	100	24	10
6	6.35	-	100	26	10

121H.150 (mm)	D (mm)	R (mm)	L (mm)	(g)	(pcs.)
2	6.35	3.5	150	35	10
2.5	6.35	3.5	150	35	10
3	6.35	3.5	150	37	10
4	6.35	4.5	150	37	10
5	6.35	5.6	150	38	10
6	6.35	-	150	39	10

121T.70 (T)	D (mm)	R (mm)	L (mm)	(g)	(pcs.)
T10	6.35	3.5	70	16	10
T15	6.35	3.5	70	16	10
T20	6.35	4.1	70	16	10
T25	6.35	4.6	70	16	10
T27	6.35	5.2	70	17	10
T30	6.35	5.7	70	17	10
T40	6.35	-	70	18	10

121T.100 (T)	D (mm)	R (mm)	L (mm)	(g)	(pcs.)
T10	6.35	3.5	100	24	10
T15	6.35	3.5	100	24	10
T20	6.35	4.1	100	24	10
T25	6.35	4.6	100	24	10
T27	6.35	5.2	100	24	10
T30	6.35	5.7	100	25	10
T40	6.35	-	100	26	10

121T.150 (T)	D (mm)	R (mm)	L (mm)	(g)	(pcs.)
T10	6.35	3.5	150	35	10
T15	6.35	3.5	150	37	10
T20	6.35	4.1	150	37	10
T25	6.35	4.6	150	37	10
T27	6.35	5.2	150	37	10
T30	6.35	5.7	150	38	10
T40	6.35	-	150	39	10

121T.70 (TH)	D (mm)	R (mm)	L (mm)	(g)	(pcs.)
T15H	6.35	3.5	70	15	10
T20H	6.35	4.1	70	16	10
T25H	6.35	4.6	70	16	10
T27H	6.35	5.2	70	17	10
T30H	6.35	5.7	70	17	10
T40H	6.35	-	70	18	10

121T.100 (TH)	D (mm)	R (mm)	L (mm)	(g)	(pcs.)
T15H	6.35	3.5	100	22	10
T20H	6.35	4.1	100	24	10
T25H	6.35	4.6	100	24	10
T27H	6.35	5.2	100	24	10
T30H	6.35	5.7	100	25	10
T40H	6.35	-	100	26	10

⚠ Tamper Resistant TORX® Bits have less strength due to special design. Make sure to use it correctly.

121T.50 (IP)	D (mm)	R (mm)	L (mm)	(g)	(pcs.)
20IP	6.35	4.1	50	12	10
25IP	6.35	4.6	50	12	10
27IP	6.35	5.2	50	13	10
30IP	6.35	5.7	50	13	10
40IP	6.35	-	50	14	10

121T.70 (IP)	D (mm)	R (mm)	L (mm)	(g)	(pcs.)
20IP	6.35	4.1	70	16	10
25IP	6.35	4.6	70	16	10
27IP	6.35	5.2	70	17	10
30IP	6.35	5.7	70	17	10
40IP	6.35	-	70	18	10

	□	D ₁ (mm)	D ₂ (mm)	L (mm)	(g)	(pcs.)	⚡
12137E	1/4"	12	13	36	22	10	*1
13137H	3/8"	13	19	42	77	10	*2
13137E	3/8"	12	19	40	40	10	*2
14137E	1/2"	12	25	48	70	10	*3

*1 Pin/O-Ring=1200A/B

*2 C-Ring=1301C, Pin/O-Ring=1301A/B → P254-255

*3 C-Ring=1401C, Pin/O-Ring=1401A/B

	□	D ₁ (mm)	D ₂ (mm)	L (mm)	(g)	(pcs.)	⚡
12142-F6.3	1/4"	16.5	13	36	22	10	*1
13142-F6.3	3/8"	16.5	19	45	60	10	*2
14142-F6.3	1/2"	16.5	25	55	100	10	*3

*1 Pin/O-Ring=1200A/B

*2 C-Ring=1301C, Pin/O-Ring=1301A/B → P254-255

*3 C-Ring=1401C, Pin/O-Ring=1401A/B

Lock & Quick Release

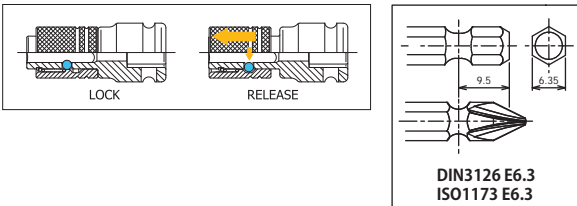

⚠ You may not hold the sliding part while moving to avoid heating up by friction and reduction by wear.

121T-70 · -100 (TH)

⚠ Tamper-Resistant TORX® Bits Punta TORX®, indeformable **⚠**

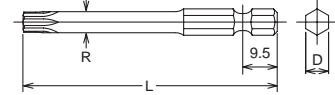

121T-50 · -70 (IP)

TORXPLUS® Bits Putas TORXPLUS®

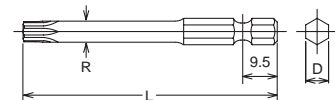

13137H

Impact Bit Holder for 1/4"(6.3) Bits Porta-punta de impacto para Puntas 1/4"(6.3)

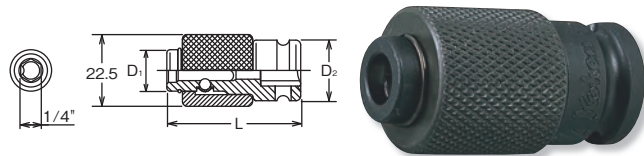

12137E

Impact Bit Holder for 1/4"(6.3) Bits Porta-punta de impacto para Puntas 1/4"(6.3)

13137E

14137E

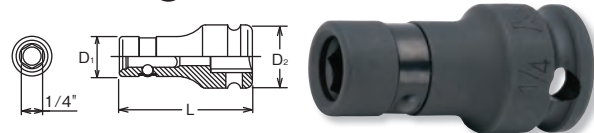

12142-F6.3

Impact Bit Holder for 1/4"(6.3) Bits Porta-punta de impacto para Puntas 1/4"(6.3) **⚠**

13142-F6.3

14142-F6.3

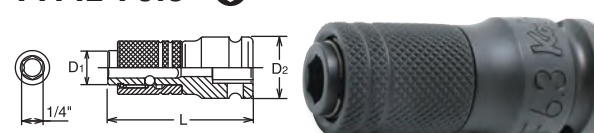



Bit & Slide Socket **1/4"**

Z-SERIES
HAND MANUALES
TITANIUM DE TITANIO
ACCESSORIES ACCESORIOS
SCREWDRIVERS DESTORNILLADORES
IMPACT DE IMPACTO
SLEEVE-DRIVE
INDUSTRIAL INDUSTRIALES
PROTECTOR PROTECTORES
AUTOMOTIVE
CONSTRUCTION CONSTRUCCIÓN
RENEWAL KITS JUEGOS DE PIEZAS REPUESTO

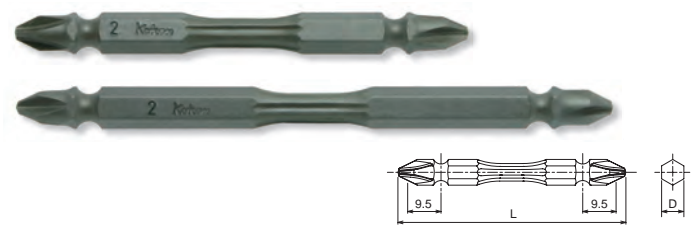
123PT-75 · -100 Double Ended Torsion Bits Puntas Phillips, simétricas, Torsion



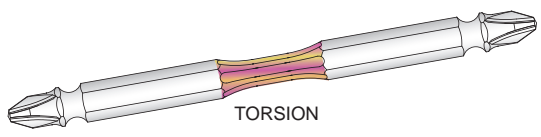

123PT (PH)	D (mm)	L (mm)	 (g)	 (pcs.)
2	6.35	75	18	10
2	6.35	100	24	10

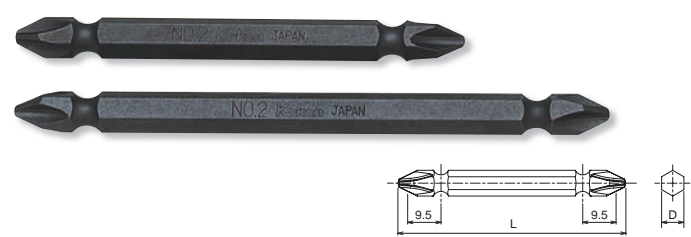

123PN-75 · -100 Double Ended Bits Puntas Phillips, simétricas

123PG-75 · -100 Magnetic type





123PN.75 123PG.75 (PH)	D (mm)	L (mm)	 (g)	 (pcs.)
1	6.35	75	16	10
2	6.35	75	16	10
3	6.35	75	17	10

123PN.100 123PG.100 (PH)	D (mm)	L (mm)	 (g)	 (pcs.)
1	6.35	100	23	10
2	6.35	100	23	10
3	6.35	100	24	10

165LM Slide Socket with Magnet



165LM.45 (mm)	D (mm)	H (mm)	L (mm)	 (g)	 (pcs.)
8	13.5	3.5	45	55	10
10	16	4.2	45	58	10
12	18.5	5.6	45	65	10
13	20	6	45	68	10
14	21	6.4	45	70	10

Slide the socket by pulling holder, and pull back the socket to lock on the bit groove.
Ring magnet holds a bolt or nut for easy work.

 You may not hold the sliding part while moving to avoid heating up by friction and reduction by wear.

 The magnet could be broken with any impacts. Please handle with care.



Nut Setter

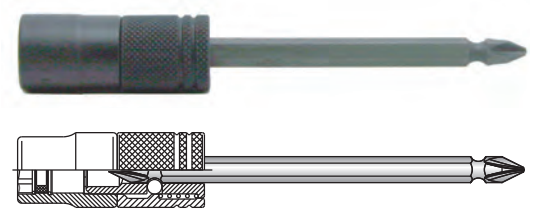

Phillips Bit

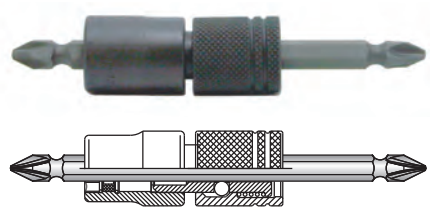

113-50 Nut Setters Vasos para apretar tuercas Hexagonales

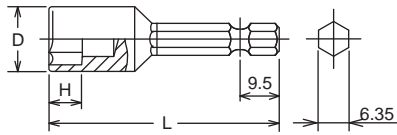

113.50 (mm)	D (mm)	H (mm)	L (mm)	(g)	(pcs.)
5.5	9	4	50	15	10
6	10	5	50	17	10
7	11	5	50	19	10
8	12	6	50	20	10
10	14.2	7	50	31	10
12	17	8	50	39	10
13	18	8	50	42	10
14	19	9	50	46	10

113.50 (inch)	D (mm)	H (mm)	L (mm)	(g)	(pcs.)
1/4	10	5	50	17	10
5/16	12	6	50	20	10
3/8	14.2	7	50	31	10
1/2	18	8	50	42	10

113-75 • -100 • -150 • -200 • -250 Nut Setters Vasos para apretar tuercas Hexagonales

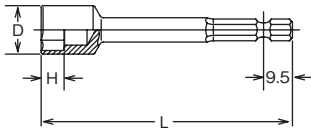

113.75 (mm)	D (mm)	H (mm)	L (mm)	(g)	(pcs.)
7	11.5	5	75	31	10
8	12.7	6	75	32	10
10	14.5	7	75	35	10
12	17	8	75	42	10
13	18	8	75	41	10
14	19	9	75	43	10

113.100 (mm)	D (mm)	H (mm)	L (mm)	(g)	(pcs.)
7	11.5	5	100	40	10
8	12.7	6	100	41	10
10	14.5	7	100	45	10
12	17	8	100	52	10
13	18	8	100	51	10
14	19	9	100	53	10

113.150 (mm)	D (mm)	H (mm)	L (mm)	(g)	(pcs.)
7	11.5	5	150	59	10
8	12.7	6	150	60	10
10	14.5	7	150	64	10
12	17	8	150	70	10
13	18	8	150	76	10
14	19	9	150	78	10

113.200 (mm)	D (mm)	H (mm)	L (mm)	(g)	(pcs.)
7	11.5	5	200	78	10
8	12.7	6	200	79	10
10	14.5	7	200	83	10
12	17	8	200	91	10
13	18	8	200	93	10
14	19	9	200	95	10

113.250 (mm)	D (mm)	H (mm)	L (mm)	(g)	(pcs.)
7	11.5	5	250	99	10
8	12.7	6	250	100	10
10	14.5	7	250	105	10
12	17	8	250	113	10
13	18	8	250	114	10
14	19	9	250	119	10

113.50 (E)	D (mm)	H (mm)	L (mm)	(g)	(pcs.)
E 4	6.1	4.5	50	12	10
E 5	7.5	4.5	50	15	10
E 6	8.3	5.0	50	17	10
E 7	8.8	5.8	50	18	10
E 8	10.1	6.6	50	19	10
E10	12	7.4	50	20	10

113-50 (E) Nut Setters, TORX® Vasos para apretar tuercas, TORX®

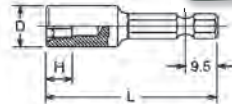

113.50	D (mm)	H (mm)	L (mm)	(g)	(pcs.)
7(2B)	11	5	50	20	10
8(2B)	12	6	50	21	10
10(2B)	14.2	7	50	26	10
13(2B)	18	8	50	31	10



113-50 (2B) Nut Setters Nut Grip® Vasos para apretar tuercas con 2 bolas

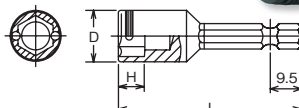

115-50  Nut Setters with Magnet
Vasos para tuercas con Imán

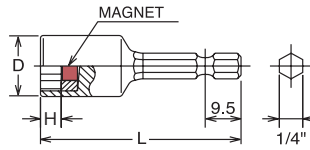

115.50 (mm)	D (mm)	H (mm)	L (mm)	(g)	(pcs.)
5.5	9	2.1	50	15	10
6	10	2.4	50	17	10
7	11	2.8	50	19	10
8	12	3.5	50	20	10
10	14.2	4.2	50	29	10
12	17	5.6	50	40	10
13	18	6	50	50	10
14	19	6.4	50	60	10

115.50 (inch)	D (mm)	H (mm)	L (mm)	(g)	(pcs.)
1/4	10	2.4	50	17	10
5/16	12	3.5	50	20	10
3/8	14.2	4.2	50	29	10
1/2	18	6	50	50	10

115-75 • -100 • -150 • -200 • -250  Nut Setters with Magnet
Vasos para tuercas con Imán

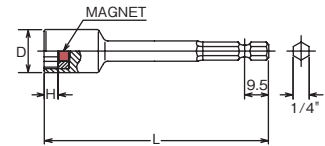

115.75 (mm)	D (mm)	H (mm)	L (mm)	(g)	(pcs.)
7	11.5	2.8	75	32	10
8	12.7	3.5	75	33	10
10	14.5	4.2	75	38	10
12	17	5.6	75	46	10
13	18	6	75	49	10
14	19	6.4	75	52	10

115.100 (mm)	D (mm)	H (mm)	L (mm)	(g)	(pcs.)
7	11.5	2.8	100	41	10
8	12.7	3.5	100	42	10
10	14.5	4.2	100	50	10
12	17	5.6	100	58	10
13	18	6	100	62	10
14	19	6.4	100	65	10

115.150 (mm)	D (mm)	H (mm)	L (mm)	(g)	(pcs.)
7	11.5	2.8	150	60	10
8	12.7	3.5	150	61	10
10	14.5	4.2	150	68	10
12	17	5.6	150	77	10
13	18	6	150	82	10
14	19	6.4	150	85	10

115.200 (mm)	D (mm)	H (mm)	L (mm)	(g)	(pcs.)
7	11.5	2.8	200	79	10
8	12.7	3.5	200	80	10
10	14.5	4.2	200	88	10
12	17	5.6	200	97	10
13	18	6	200	102	10
14	19	6.4	200	105	10

115.250 (mm)	D (mm)	H (mm)	L (mm)	(g)	(pcs.)
7	11.5	2.8	250	101	10
8	12.7	3.5	250	103	10
10	14.5	4.2	250	110	10
12	17	5.6	250	118	10
13	18	6	250	122	10
14	19	6.4	250	124	10



113UN-100 · -150 · -200 6-point Universal Joint Nut Setters Vasos para apretar tuercas Hexagonales con Articulación Universal



113UN.100 (mm)	D (mm)	H (mm)	L (mm)	(g)	(pcs.)
8	13	7	100	50	10
10	15	8	100	53	10
12	17	10	100	56	10
13	18	10	100	65	10
14	19.2	10	100	67	10

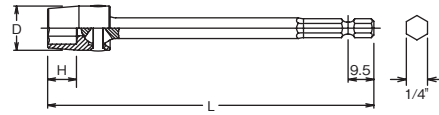

113UN.150 (mm)	D (mm)	H (mm)	L (mm)	(g)	(pcs.)
8	13	7	150	65	10
10	15	8	150	70	10
12	17	10	150	77	10
13	18	10	150	92	10
14	19.2	10	150	92	10

113UN.200 (mm)	D (mm)	H (mm)	L (mm)	(g)	(pcs.)
8	13	7	200	75	10
10	15	8	200	87	10
12	17	10	200	98	10
13	18	10	200	116	10
14	19.2	10	200	116	10

115G-75 · -100 · -150 · -200 · -250 Nut Setters with sliding Magnet Vasos para tuercas con Imán Corredizo

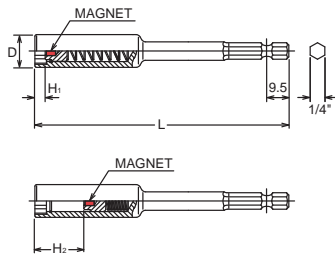

115G.75 (mm)	D (mm)	H ₁ (mm)	H ₂ (mm)	L (mm)	(g)	(pcs.)
7	11.5	3.5	26	75	34	10
8	12.7	4	26	75	41	10
10	14.5	4.5	26	75	48	10
12	17	6	26	75	65	10
13	18	6.5	25	75	70	10
14	19	7	24	75	73	10

115G.100 (mm)	D (mm)	H ₁ (mm)	H ₂ (mm)	L (mm)	(g)	(pcs.)
7	11.5	3.5	26	100	51	10
8	12.7	4	26	100	51	10
10	14.5	4.5	26	100	57	10
12	17	6	26	100	77	10
13	18	6.5	25	100	80	10
14	19	7	24	100	82	10

115G.150 (mm)	D (mm)	H ₁ (mm)	H ₂ (mm)	L (mm)	(g)	(pcs.)
7	11.5	3.5	26	150	67	10
8	12.7	4	26	150	70	10
10	14.5	4.5	26	150	77	10
12	17	6	26	150	95	10
13	18	6.5	25	150	100	10
14	19	7	24	150	105	10

115G.200 (mm)	D (mm)	H ₁ (mm)	H ₂ (mm)	L (mm)	(g)	(pcs.)
7	11.5	3.5	26	200	86	10
8	12.7	4	26	200	89	10
10	14.5	4.5	26	200	96	10
12	17	6	26	200	119	10
13	18	6.5	25	200	125	10
14	19	7	24	200	128	10

115G.250 (mm)	D (mm)	H ₁ (mm)	H ₂ (mm)	L (mm)	(g)	(pcs.)
8	12.7	4	26	250	110	10
10	14.5	4.5	26	250	120	10
12	17	6	26	250	130	10

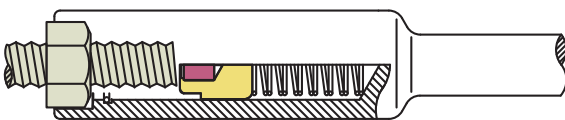

Sliding magnet system provides bolt clearance and magnetic function at the same time. The item 115G is mainly designed for assembly line work.

El sistema de imán corredizo proporciona espacio para el perno y al mismo tiempo acción magnética. El artículo 115G está diseñado específicamente para líneas de montaje.

Z-SERIES
HAND
MANUALES
TITANIUM
DE TITANIO
ACCESSORIES
ACCESORIOS
SCREWDRIVERS
DESTORNILLADORES
IMPACT
DE IMPACTO
SLEEVE-DRIVE
INDUSTRIAL
INDUSTRIALES
PROTECTOR
PROTECTORES
AUTOMOTIVE
CONSTRUCTION
CONSTRUCCION
RENEWAL KITS
JUEGOS DE PIEZAS/REPUESTO

Z-SERIES
HAND
MANUALES
TITANIUM
DE TITANIO
ACCESSORIES
ACCESORIOS
SCREWDRIVERS
DESTORNILLADORES
IMPACT
DE IMPACTO
SLEEVE-DRIVE
INDUSTRIAL
INDUSTRIALES
PROTECTOR
PROTECTORES
AUTOMOTIVE
CONSTRUCTION
CONSTRUCCIÓN
RENEWAL KITS
JUEGOS DE PIEZAS/REPUES

183H-35 · -75 · -150

Hex Bits
Puntas Hexagonales

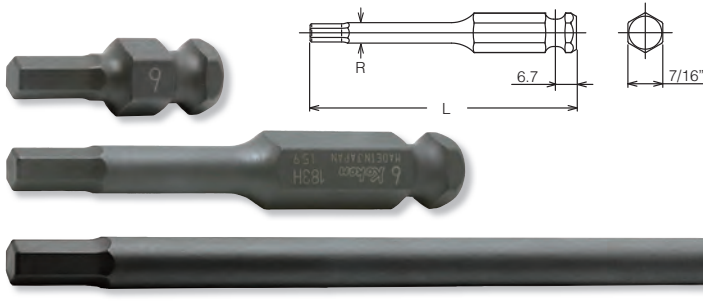

183H.35 (inch)	L (mm)	(g)	(pcs.)
3/16	35	15	10
7/32	35	16	10
1/4	35	18	10
5/16	35	20	10
3/8	35	26	10
7/16	35	28	10
1/2	35	38	10

183H.35 (mm)	L (mm)	(g)	(pcs.)
3	35	15	10
4	35	15	10
5	35	15	10
6	35	18	10
7	35	19	10
8	35	20	10
10	35	26	10
11	35	28	10
12	35	30	10
14	35	35	10
16	35	47	10
17	35	50	10
18	35	53	10
19	35	56	10

183H.75 (mm)	L (mm)	R (mm)	(g)	(pcs.)
3	75	6	34	10
4	75	6	35	10
5	75	6.5	36	10
6	75	7.5	39	10
7	75	8.5	44	10
8	75	9.5	47	10
10	75	-	57	10
11	75	-	60	10
12	75	-	65	10
14	75	-	79	10

183H.150 (mm)	L (mm)	R (mm)	(g)	(pcs.)
4	150	6	51	10
5	150	6.5	55	10
6	150	7.5	65	10
8	150	9.5	87	10
10	150	-	118	10
12	150	-	136	10

183T-35 · -75 · -150 (T)

TORX® Bits
Puntas TORX®

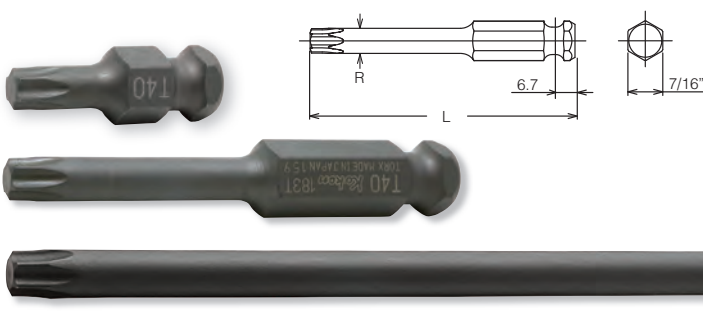

183T.35 (T)	L (mm)	(g)	(pcs.)
T25	35	18	10
T30	35	18	10
T40	35	20	10
T45	35	22	10
T50	35	26	10
T55	35	30	10
T60	35	38	10

183T.75 (T)	L (mm)	R (mm)	(g)	(pcs.)
T30	75	6	35	10
T40	75	6.9	37	10
T45	75	8	41	10
T50	75	9	45	10
T55	75	11.4	55	10
T60	75	13.5	67	10

183T.150 (T)	L (mm)	R (mm)	(g)	(pcs.)
T30	150	6	50	10
T40	150	6.9	58	10
T45	150	8	70	10
T50	150	9	82	10
T55	150	11.4	113	10

183T-35 · -75 (IP)

TORXPLUS® Bits
Puntas TORXPLUS®

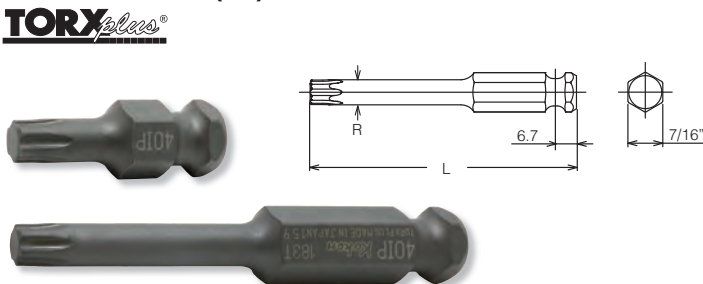

183T.35 (IP)	L (mm)	(g)	(pcs.)
30IP	35	18	10
40IP	35	20	10
45IP	35	22	10
50IP	35	26	10
55IP	35	30	10
60IP	35	38	10

183T.75 (IP)	L (mm)	R (mm)	(g)	(pcs.)
30IP	75	6	35	10
40IP	75	6.8	37	10
45IP	75	8	41	10
50IP	75	9	45	10
55IP	75	11.4	56	10
60IP	75	13.5	67	10

TORX is a registered trademark of Acument Intellectual Properties, LLC.
TORX es una marca registrada de Acument Intellectual Properties, LLC.
TORXPLUS is a registered trademark of Acument Intellectual Properties, LLC.
TORXPLUS es una marca registrada de Acument Intellectual Properties, LLC.

183X.35 (XZN)	L (mm)	(g)	(pcs.)
M 4	35	18	10
M 5	35	18	10
M 6	35	20	10
M 8	35	22	10
M10	35	26	10
M12	35	30	10
M14	35	38	10

183X-35 · -75 · -150 (XZN)

XZN Bits
Puntas XZN

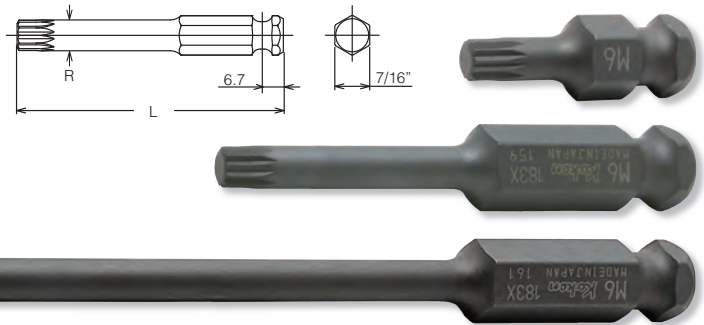

183X.75 (XZN)	L (mm)	R (mm)	(g)	(pcs.)
M 4	75	6	34	10
M 5	75	6	34	10
M 6	75	6.2	36	10
M 8	75	7.4	39	10
M10	75	9.8	54	10
M12	75	11.7	57	10
M14	75	13.5	67	10

183X.150 (XZN)	L (mm)	R (mm)	(g)	(pcs.)
M 5	150	6	50	10
M 6	150	6.2	53	10
M 8	150	7.4	64	10
M10	150	9.8	93	10
M12	150	11.7	121	10

	□	D (mm)	L (mm)	(g)	(pcs.)	⚡
13134	3/8"	22	32	70	10	*1
14134	1/2"	25	38	90	10	*2
16134	3/4"	44	52	200	2	*3

*1 C-Ring=1302C, Pin/O-Ring=1302A/B
*2 C-Ring=1401C, Pin/O-Ring=1401A/B
*3 C-Ring=1600C, Pin/O-Ring=1601A/B

→ P254-255

Replacement Screw : M8x5, ● 4mm

For
DIN3126 / ISO1173 E11.2 Bits

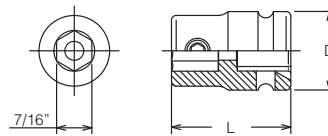
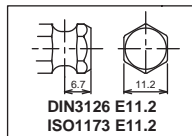

	□	D ₁ (mm)	D ₂ (mm)	L (mm)	(g)	(pcs.)	⚡
13142-F11.2	3/8"	18.9	22	46	116	10	*1
14142-F11.2	1/2"	18.9	25	46	207	10	*2

*1 C-Ring=1302C, Pin/O-Ring=1302A/B
*2 C-Ring=1401C, Pin/O-Ring=1401A/B

→ P254-255

For
DIN3126 / ISO1173 E11.2 Bits

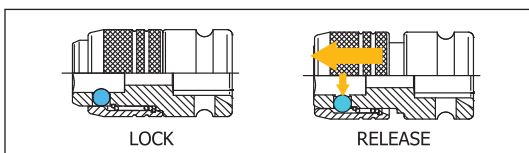
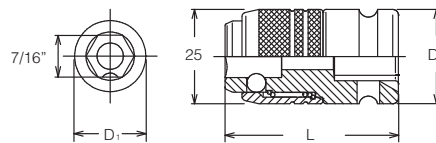
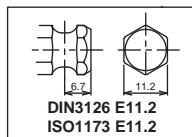

⚠ You may not hold the sliding part while moving to avoid heating up by friction and reduction by wear.

Z-SERIES
HAND
MANUALES
TITANIUM
DE TITANIO
ACCESSORIES
ACCESORIOS
SCREWDRIVERS
DESTORNILLADORES
IMPACT
DE IMPACTO
SLEEVE-DRIVE
INDUSTRIAL
INDUSTRIALES
PROTECTOR
PROTECTORES
AUTOMOTIVE
CONSTRUCTION
CONSTRUCCION
RENEWAL KITS
JUEGOS DE HERRAMIENTAS

110-35B · -50B · -100B · -150B  Adaptors
Adaptadores
-35P · -50P · -100P · -150P



110		TYPE	L (mm)	(g)	(pcs.)
35B	1/4"	Ball	35	9	10
35P		Pin	35	9	10
50B		Ball	50	15	10
50P		Pin	50	15	10
100B		Ball	100	34	10
100P		Pin	100	34	10
150B	Ball	150	54	10	
150P	Pin	150	54	10	

◆ DIN 3126 / ISO 1173 Form E 6.3

112-50B · -100B · -150B  Adaptors
Adaptadores
-50P · -100P · -150P

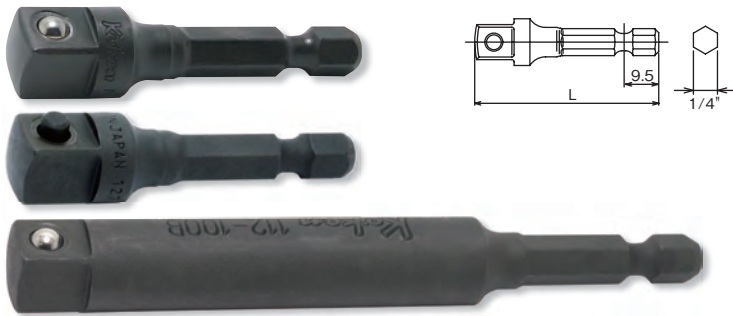

112		TYPE	L (mm)	(g)	(pcs.)
50B	3/8"	Ball	50	21	10
50P		Pin	50	21	10
100B		Ball	100	71	10
100P		Pin	100	71	10
150B		Ball	150	121	10
150P		Pin	150	121	10

◆ DIN 3126 / ISO 1173 Form E 6.3

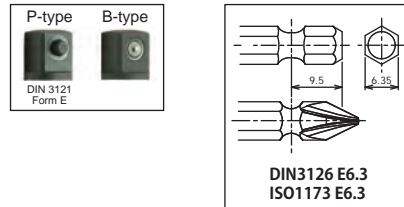

135E-60B · -60P  Adaptors
Adaptadores



135E		TYPE	L (mm)	(g)	(pcs.)
60B	1/2"	Ball	60	46	10
60P		Pin	60	46	10

◆ DIN 3126 / ISO 1173 Form E 6.3

117-50B · -100B  Adaptors
Adaptadores
-50P · -100P



117		TYPE	L (mm)	(g)	(pcs.)
50B	1/4"	Ball	50	15	10
50P		Pin	50	15	10
100B		Ball	100	71	10
100P		Pin	100	71	10

◆ DIN 3126 / ISO 1173 Form G7

120-50B · -50P  Adaptors
Adaptadores



120		TYPE	L (mm)	(g)	(pcs.)
50B	3/8"	Ball	50	27	10
50P		Pin	50	27	10

◆ DIN 3126 / ISO 1173 Form E8

186-75P  Adaptors with Pin
Adaptadores con Perno

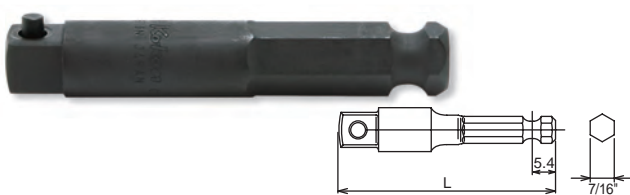

186-75P		L (mm)	(g)	(pcs.)
3/8	3/8"	75	65	10
1/2	1/2"	75	85	10

◆ DIN 3126 / ISO 1173 Form E11.2

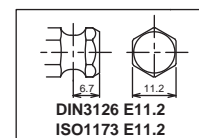

BD022-120P  Hammer Drill Adaptor
Adaptador para Taladro de Percusión

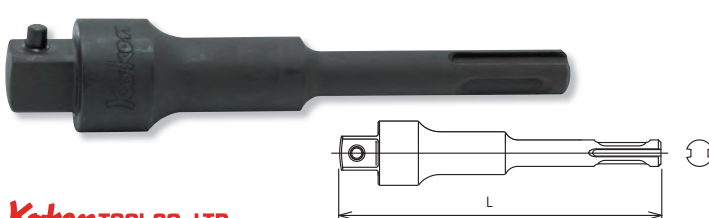

BD022-120P		L (mm)	(g)	(pcs.)
3/8	3/8"	120	100	10
1/2	1/2"	120	160	10

Screwdrivers



Screwdrivers

Z-SERIES
HAND MANUALES
TITANIUM DE TITANIO
ACCESSORIES ACCESORIOS
SCREWDRIVERS DESTORNILLADORES
IMPACT DE IMPACTO
SLEEVE-DRIVE
INDUSTRIAL INDUSTRIALES
PROTECTOR PROTECTORES
AUTOMOTIVE
CONSTRUCTION CONSTRUCCION
RENEWAL KITS JUEGOS DE PIEZAS REPUESTO

167M · 167A Socket Drivers Destornilladores de Vaso

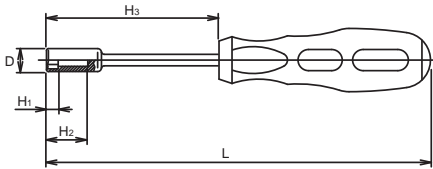



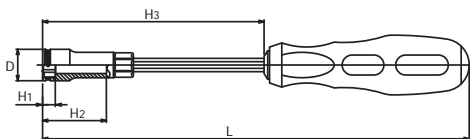

167M (mm)	D (mm)	H ₁ (mm)	H ₂ (mm)	H ₃ (mm)	L (mm)	 (g)	 (pcs.)
3	5.8	3	25	125	225	62	6
3.5	5.8	3	25	125	225	62	6
4	6.7	3.5	25	125	225	64	6
4.5	7.2	4.5	25	125	225	65	6
5	7.8	5	25	125	225	66	6
5.5	8.4	5.5	25	125	225	68	6
6	9.1	6	25	125	225	70	6
7	10.9	6.5	25	125	235	101	6
8	12	7	25	125	235	103	6
9	13.2	7.5	25	125	235	107	6
10	14.5	8	25	125	235	111	6
11	15.9	8.5	25	125	245	155	6
12	16.8	9	25	125	245	161	6
13	18.2	9.5	25	125	245	167	6
14	19.2	11	25	125	245	178	6

167A (inch)	D (mm)	H (mm)	H ₁ (mm)	H ₂ (mm)	L (mm)	 (g)	 (pcs.)
1/4	9.1	6	25	125	225	70	6

167C (2B) Interchangeable Socket Driver, Nut Grip®





167C(2B) (mm)	D (mm)	H ₁ (mm)	H ₂ (mm)	H ₃ (mm)	L (mm)	 (g)	 (pcs.)
7(2B)	11.5	4	38	122	235	120	6
8(2B)	12.3	5	38	122	235	125	6
10(2B)	14.2	6	38	122	235	130	6
12(2B)	17.3	7	38	122	235	135	6

167C/3-2B	4 Pieces Set/  =280g
PLASTIC BAG	
Socket Drivers	
 Socket:	7, 8, 10
 Grip:	167C-GRIP

168H-B  Ball point Hex Screwdrivers 



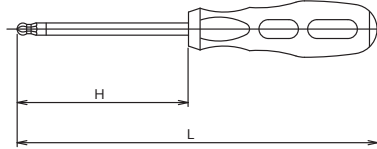

168H (mm)	H (mm)	L (mm)	 (g)	 (pcs.)
3B	80	150	25	6
4B	125	225	60	6
5B	125	235	85	6
6B	125	245	150	6
7B	125	245	151	6
8B	125	245	153	6





 Ball point Hex Screwdrivers have less strength due to the special design. Make sure to use them correctly.

168T (TH)  Tamper-Resistant TORX® Screwdrivers 

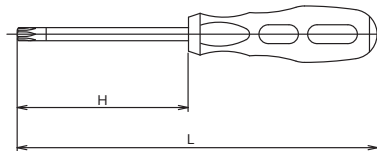

168T (TH)	H (mm)	L (mm)	 (g)	 (pcs.)
T10H	80	150	25	6
T15H	80	150	25	6
T20H	125	225	60	6
T25H	125	225	60	6
T27H	125	235	90	6
T30H	125	235	92	6
T40H	125	245	153	6



 Tamper Resistant TORX® Screwdrivers have less strength due to the special design. Make sure to use it correctly.

168T/7 (TH)  Set Juego 

168T/7-TH	 (g)
168T-T10H, T15H, T20H, T25H, T27H, T30H, T40H	480



168P (PZ)  PZ Screwdrivers

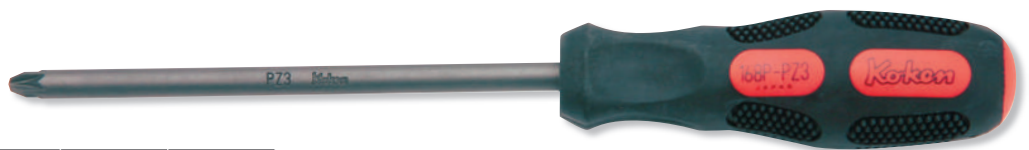

168P (PZ)	H (mm)	L (mm)	 (g)	 (pcs.)
PZ1	75	175	78	6
PZ2	100	210	129	6
PZ3	150	270	203	6

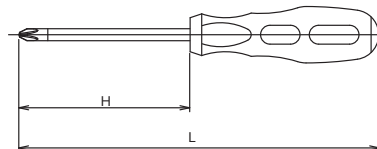

Screwdrivers

Z-SERIES
HAND MANUALES
TITANIUM DE TITANIO
ACCESSORIES ACCESORIOS
SCREWDRIVERS DESTORNILLADORES
IMPACT DE IMPACTO
SLEEVE-DRIVE
INDUSTRIAL INDUSTRIALES
PROTECTOR PROTECTORES
AUTOMOTIVE
CONSTRUCTION CONSTRUCCIÓN
RENEWAL KITS JUEGOS DE PIEZAS REPUES TO

166P  Screwdrivers (Blade-Through type)
Destornilladores

166S 

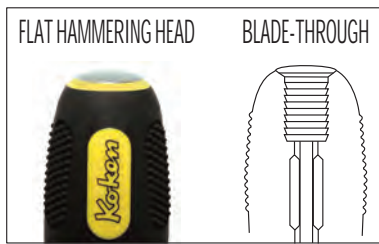
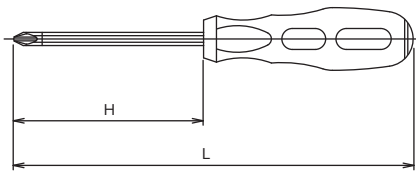
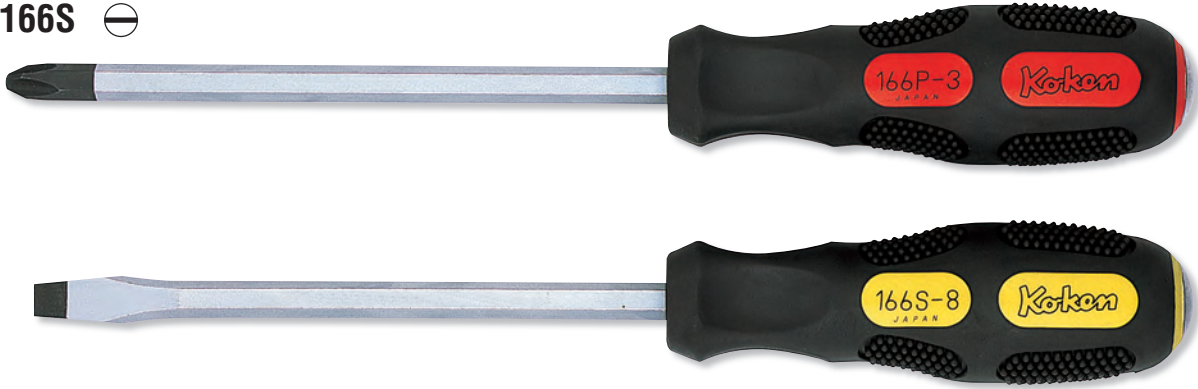



166P (PH)	H (mm)	L (mm)	(g)	(pcs.)
1	75	175	78	6
2	100	210	129	6
3	150	270	203	6

166S	H (mm)	L (mm)	(g)	(pcs.)
5	75	175	78	6
6	100	210	129	6
8	150	270	203	6



166PS/6   Set Juego



166PS/6	6 Pieces Set/△=885g
CARDBOARD BOX:W280xH115xT40mm	
Screwdrivers	
	166P Screwdrivers 1, 2, 3
	166S Screwdrivers 5, 6, 8

PK166PS/6   Set Juego



PK166PS/6	6 Pieces Set/△=950g
PLASTIC TRAY	
Screwdrivers	
	166P Screwdrivers 1, 2, 3
	166S Screwdrivers 5, 6, 8



Z-SERIES
HAND
MANUALES
TITANIUM
DE TITANIO
ACCESSORIES
ACCESORIOS
SCREWDRIVERS
DESTORNILLADORES
IMPACT
DE IMPACTO
SLEEVE-DRIVE
INDUSTRIAL
INDUSTRIALES
PROTECTOR
PROTECTORES
AUTOMOTIVE
CONSTRUCTION
CONSTRUCCION
RENEWAL KITS
JUEGOS DE PIEZAS/REPUESTO

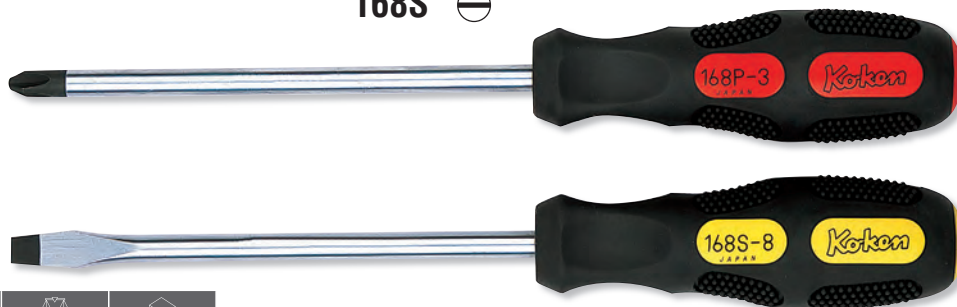
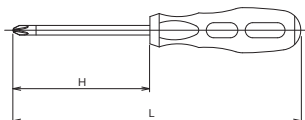

168P  Screwdrivers
Destornilladores
168S 



168P (PH)	H (mm)	L (mm)	(g)	(pcs.)
1	75	175	59	6
2	100	210	86	6
2(150)	150	260	100	6
2(200)	200	310	111	6
2(300)	300	410	133	6
3	150	270	150	6

168S	H (mm)	L (mm)	(g)	(pcs.)
5	75	175	59	6
6	100	210	86	6
6(150)	150	260	100	6
6(200)	200	310	111	6
6(300)	300	410	133	6
8	150	270	150	6

168PS/6 6 Pieces Set/  =660g
 CARDBOARD BOX:W280xH115xT40mm
 Screwdrivers
 **168P** Screwdrivers 1, 2, 3
 **168S** Screwdrivers 5, 6, 8

PK168PS/6 6 Pieces Set/  =720g
 PLASTIC TRAY
 Screwdrivers
 **168P** Screwdrivers 1, 2, 3
 **168S** Screwdrivers 5, 6, 8

168PS/6   Set Juego



PK168PS/6   Set Juego

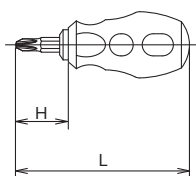

168CS	H (mm)	L (mm)	(g)	(pcs.)
2x6	22	86	46	6

168CS   Interchangeable Screwdrivers, Stubby

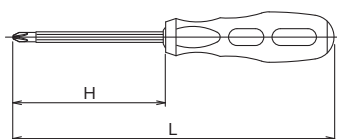

168C	H (mm)	L (mm)	(g)	(pcs.)
2x6	100	210	108	6
2x6(150)	150	260	120	6
2x6(200)	200	310	133	6

168C   Interchangeable Screwdrivers



Screwdrivers

Z-SERIES
HAND MANUALES
TITANIUM DE TITANIO
ACCESSORIES ACCESORIOS
SCREWDRIVERS DESTORNILLADORES
IMPACT DE IMPACTO
SLEEVE-DRIVE
INDUSTRIAL INDUSTRIALES
PROTECTOR PROTECTORES
AUTOMOTIVE
CONSTRUCTION CONSTRUCCIÓN
RENEWAL KITS JUEGOS DE PIEZAS REPUESTO

2769N-150 • -220 Spin Type Handle Mango Tipo Destornillador ⚠

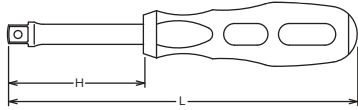

2769N		H (mm)	L (mm)	(g)	(pcs.)
150	1/4"	50	150	68	2
220		120	220	100	2

⚠ Plastic or rubber handles are not intended to act as insulation.
Los mangos de plástico o de goma no están previstos para aislamiento.

2769NWF-150 • -220 Spin Type Handle (Wobble-Fix) Mango Tipo Destornillador (Articulado-Fijo) ⚠

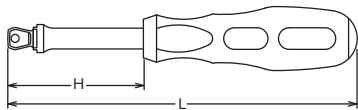

2769NWF		H (mm)	L (mm)	(g)	(pcs.)
150	1/4"	50	150	68	2
220		120	220	100	2

Wobble-Fix Extension Bar
Two way usage : One for as a flexible extension bar to provide at 15° angle operation, the other for use as a normal extension bar. This usage is Patent.

Alargadera Articulada-Fija
Dos formas de utilización : Una como alargadera flexible para poder trabajar con un ángulo de 15° y otra para utilizarse como alargadera normal. Esta aplicación está patentada.

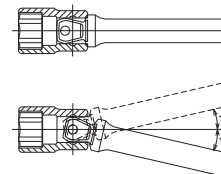

3769N-160 • -230 Spin Type Handle Mango Tipo Destornillador ⚠

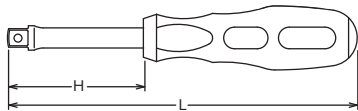

3769N		H (mm)	L (mm)	(g)	(pcs.)
160	3/8"	50	160	96	2
230		120	230	126	2

3769NWF-160 • -230 Spin Type Handle (Wobble-Fix) Mangos Tipo Destornillador (Articulado-Fijo) ⚠

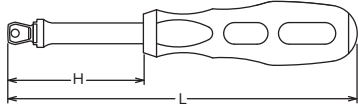

3769NWF		H (mm)	L (mm)	(g)	(pcs.)
160	3/8"	50	160	96	2
230		120	230	126	2

Impact Sockets

1/4"

3/8"

1/2"

5/8"

3/4"

1"

1-1/2"











































2-1/2"

3-1/2"



Impact Sockets

Impact Sockets	Square Drive																
	1/4" (6.35mm)SQ.			3/8" (9.5mm)SQ.			1/2" (12.7mm)SQ.			5/8" (15.9mm)SQ.			3/4" (19mm)SQ.				
	No.	mm	Page	No.	mm	Page	No.	mm	Page	No.	mm	Page	No.	mm	Page		
Standard Sockets	6-point	12400M 12400A	mm inch	186 186	13400M 13400A	mm inch	189 189	14400M 14400A	mm inch	202 202	15400M 15400A	mm inch	218 218	16400M 16400A	mm inch	220 220	
	6-point (Thin-walled)				13401M 13401A	mm inch	190 190	14401M 14401A	mm inch	203 203				16401M 16401A	mm inch	221 221	
	6-point (with Magnet)	12400MG 12400AG	mm inch	186 186	13400MG 13400AG	mm inch	189 189	14400MG	mm	204							
	12-point				13405M 13405A	mm inch	189 189	14405M 14405A	mm inch	202 202				16405M 16405A	mm inch	220 220	
	12-point (Thin-walled)				13406M 13406A	mm inch	190 190	14406M 14406A	mm inch	203 203							
	Surface	12410M	mm	186	13410M	mm	191	14410M	mm	204	15410M	mm	218	16410M	mm	221	
	PATHFINDER®	12465M	mm	187	13465M	mm	191	14465M	mm	205							
	TORX® (E)	12425	TORX®	187	13425	TORX®	191	14425	TORX®	205				16425	TORX®	222	
	TORXplus® (EP)				13425-EPL	TORXplus®	191	14425-EPL	TORXplus®	205				16425-EPL	TORXplus®	222	
	LH-S				13401LH	LH-STIX®	192	14401LH	LH-STIX®	206							
	for Self Tapping Screws	12460M 12460A	mm inch	187 187	13460M 13460A	mm inch	192 192										
	for Self Tapping Screws (with Magnet)	12460MG 12460AG	mm inch	187 187	13460MG 13460AG	mm inch	192 192										
	Double Square							14415M	mm	205							
	for Weld Nut				13400-WN		192	14400-WN		206							
	Short Sockets	6-point (Thin-walled)				13401MS	mm	190	14401MS	mm	204						
Semi Deep Sockets	6-point (Thin-walled)				13301X	mm	193	14301X	mm	206				16301X	mm	222	
	6-point (with Slide Magnet)				13300XG	mm	193										
Deep Sockets	6-point	12300M	mm	188	13300M 13300A	mm inch	193 193	14300M 14300A	mm inch	207 207	15300M	mm	219	16300M 16300A	mm inch	223 223	
	6-point (Thin-walled)				13301M 13301A	mm inch	194 194	14301M 14301A	mm inch	207 207				16301M 16301A	mm inch	223 223	
	6-point (with Slide Magnet)	12300G	mm	188	13300G	mm	195	14300G	mm	209							
	12-point				13305M	mm	194	14305M	mm	208				16305M	mm	224	
	12-point (Thin-walled)				13306M	mm	194	14306M	mm	208							
	Surface				13310M	mm	194	14310M	mm	208	15310M	mm	219	16310M	mm	224	
	PATHFINDER®	12365M	mm	188	13365M	mm	195	14365M	mm	209							
Extension Sockets	6-point				13145M	mm	199	14145M	mm	214							
	6-point (with Magnet)				13145MG	mm	199										
	12-point				13145M(12P)	mm	199										
Universal Sockets	6-point				13440M 13440A	mm inch	195 195	14440M 14440A	mm inch	209 209							
	6-point (Extension)				13146M	mm	200	14146M	mm	214							
	TORX® (E)				13440T	TORX®	195										
Bit Sockets	Hexagon				13012M	mm	196	14012M	mm	210							
	TORX® (T)				13025	TORX®	196	14025	TORX®	210							
Bit Sockets (Bit changeable)	Hexagon				13134M	mm	198	14134M	mm	212				16106-16 16107-22	mm mm	225 227	
	TORX® (T)				13134T(T)	TORX®	198	14134T(T)	TORX®	212				16106-16(T)	TORX®	225	
	TORXplus® (IP)				13134T(IP)	TORXplus®	198	14134T(IP)	TORXplus®	212							
Universal Bit Sockets	XZN (Triple Square)				13134X(XZN)	XZN	198	14134X(XZN)	XZN	212				16106-16(XZN)	XZN	225	
	Hexagon				13430M	mm	195										
Hexagon (Extension)					13147M	mm	200	14147M	mm	214							
Extension Bars		12760		188	13760		200	14760		215			16760		227		
Universal Joints		12770		188	13770 13771 13772		201 201 201	14770 14771 14772		215 215 215	15770		219	16770 16771		228 228	
					13322A 13344A		201 201	14433A 14455A 14466A		216 216 216	15544A 15566A		219	16644A 16655A 16688A		228 228 228	
					12222AL		188	13333AL		201	14444AL		215	15555AL		219	
Locking Adaptors																	

Impact Sockets		Square Drive											
		1"(25.4mm)SQ.		1.1/2"(38.1mm)SQ.		2.1/2"(63.5mm)SQ.		3.1/2"(88.9mm)SQ.					
		No.	Page	No.	Page	No.	Page	No.	Page				
Standard Sockets	 6-point	18400M mm 230 18400A inch 230	17400M mm 240 17400A inch 240	19400M mm 244 19400A inch 244	10400M mm 246 10400A inch 246								
	 6-point (Thin-walled)	18401M mm 231 18401A inch 231											
	 6-point (with Magnet)												
	 12-point	18405M mm 231 18405A inch 231	17405M mm 241 17405A inch 241										
	 12-point (Thin-walled)												
	 Surface	18410M mm 232											
	 PATHFINDER®												
	 TORX® (E)												
	 TORXplus® (EP)												
	 LH-S												
	 for Self Tapping Screws												
	 for Self Tapping Screws (with Magnet)												
	 Double Square												
	 for Weld Nut												
Short Sockets	 6-point (Thin-walled)												
Semi Deep Sockets	 6-point (Thin-walled)	18301X mm 233											
	 6-point (with Slide Magnet)												
Deep Sockets	 6-point	18300M mm 233 18300A inch 233	17300M mm 241 17300A inch 241	19300M mm 245									
	 6-point (Thin-walled)	18301M mm 234 18301A inch 234											
	 6-point (with Slide Magnet)												
	 12-point												
	 12-point (Thin-walled)												
	 Surface	18310M mm 234											
	 PATHFINDER®												
Extension Sockets	 6-point	18104M mm 232											
	 6-point (with Magnet)												
	 12-point												
Universal Sockets	 6-point												
	 6-point (Extension)												
	 TORX® (E)												
Bit Sockets	 Hexagon												
	 TORX® (T)												
Bit Sockets (Bit changeable)	 Hexagon	18106-16 mm 235 18107-22 mm 237	17108-32 mm 242										
	 TORX® (T)	18106-16(T) TORX® 235											
	 TORXplus® (IP)												
	 XZN (Triple Square)	18106-16(XZN) XZN 235											
Universal Bit Sockets	 Hexagon												
	 Hexagon (Extension)												
Extension Bars		18760 238	17760 243	19760 245									
Universal Joints		18770 238 18771 238	17770 243	19770 245									
Adaptors		18866A 239 18877A 239	17788A 243 17799A 243	19977A 245 10099A 246									
Locking Adaptors		18888AL 238											

Z-SERIES
HAND
MANUALES
DE TITANIO
TITANIUM
ACCESORIOS
ACCESORIOS
DESTORNILLADORES
SCREWDRIEVERS
DE IMPACTO
SLEEVE-DRIVE
INDUSTRIAL
INDUSTRIALES
PROTECTOR
PROTECTORES
AUTOMOTIVE
CONSTRUCTION
RENEWAL KITS
JUEGOS DE PIEZAS/REPUESTO

Z-SERIES
HAND MANUALES
TITANIUM DE TITANIO
ACCESSORIES ACCESORIOS
SCREWDRIVERS DESTORNILLADORES
IMPACT DE IMPACTO
SLEEVE-DRIVE
INDUSTRIAL INDUSTRIALES
PROTECTOR PROTECTORES
AUTOMOTIVE
CONSTRUCTION CONSTRUCCIÓN
RENEWAL KITS JUEGOS DE PIEZAS/REPUES

12400M • 12400A ○ 6-point Sockets Vasos Hexagonales

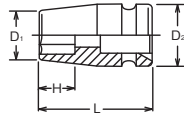

FLAT DRIVE®

FLAT DRIVE®

Flat drive is designed to guarantee a flat surface contact between the socket and the bolt/nut. The Flat contact reduces wear and allows to transmit a higher torque value. The Flat Drive System is also used for the square drive end as well as the hexagonal or bi-hexagonal openings of the socket.

El diseño de contacto plano garantiza una superficie de contacto plana entre el vaso y el perno/tuerca. El contacto plano reduce el desgaste y permite transmitir más par. El Sistema de Contacto Plano se utiliza tanto para el extremo del cuadrado conductor como para la boca del vaso Hex o Bihex.

12400M (mm)	D ₁ (mm)	D ₂ (mm)	H (mm)	L (mm)	(g)	(pcs.)	⊕
4	7.5	13	4	23	14	10	*1
4.5	8.1	13	4	23	14	10	*1
5	8.8	13	4	23	14	10	*1
5.5	9.4	13	4	23	14	10	*1
6	10	13	5	23	14	10	*1
7	11.3	13	5	23	14	10	*1
8	12.5	13	6	23	14	10	*1
9	13.8	13	7	23	14	10	*1
10	15	13	7	23	15	10	*1
11	16.3	13	8	23	18	10	*1
12	17.5	13	8	23	19	10	*1
13	18.8	13	8	23	19	10	*1
14	20	13	9	23	20	10	*1

12400A (inch)	D ₁ (mm)	D ₂ (mm)	H (mm)	L (mm)	(g)	(pcs.)	⊕
5/32	7.5	13	4	23	14	10	*1
3/16	8.1	13	4	23	14	10	*1
7/32	9.4	13	4	23	16	10	*1
1/4	10	13	5	23	14	10	*1
9/32	11.3	13	5	23	14	10	*1
5/16	12.5	13	6	23	14	10	*1
11/32	13.8	13	7	23	14	10	*1
3/8	15	13	7	23	15	10	*1
7/16	16.3	13	8	23	18	10	*1
1/2	18.8	13	8	23	19	10	*1
9/16	20	13	9	23	20	10	*1

*1 Pin/O-Ring=1200A/B → P255

12400MG • 12400AG ○ 6-point Sockets with Magnet Vasos Hexagonales con Imán

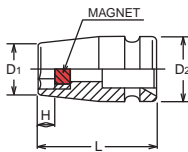

12400MG (mm)	D ₁ (mm)	D ₂ (mm)	H (mm)	L (mm)	(g)	(pcs.)	⊕
4	7.5	13	2.1	23	12	10	*1
4.5	8.1	13	2.1	23	13	10	*1
5	8.8	13	2.1	23	15	10	*1
5.5	9.4	13	2.1	23	15	10	*1
6	10	13	2.4	23	16	10	*1
7	11.3	13	2.8	23	16	10	*1
8	12.5	13	3.5	23	17	10	*1
9	13.8	13	3.8	23	18	10	*1
10	15	13	4.2	23	18	10	*1
11	16.3	13	4.9	23	21	10	*1
12	17.5	13	5.6	25	21	10	*1
13	18.8	13	6	25	21	10	*1
14	20	13	6.4	25	20	10	*1

12400AG (inch)	D ₁ (mm)	D ₂ (mm)	H (mm)	L (mm)	(g)	(pcs.)	⊕
3/16	8.1	13	2.1	23	13	10	*1
1/4	10	13	2.4	23	16	10	*1
5/16	12.5	13	3.5	23	17	10	*1
11/32	13.8	13	3.8	23	18	10	*1
3/8	15	13	4.2	23	18	10	*1
7/16	16.3	13	4.9	23	21	10	*1
1/2	18.8	13	6	25	21	10	*1
9/16	20	13	6.4	25	20	10	*1

*1 Pin/O-Ring=1200A/B → P255

12410M ○ Surface Drive Sockets Vasos Surface Drive (de Contacto Curvo)

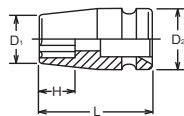

SURFACE DRIVE

SURFACE DRIVE

Surface drive sockets are designed to retain contact with flat sides of nut to transmit high torque and reduce nut wear. These sockets are ideal for use on polished nuts, aluminum nuts and nuts with worn out points.

Los vasos de contacto curvo se diseñan para mantener el contacto con las caras planas de la tuerca y transmitir un alto par reduciendo el desgaste de la tuerca. Estos vasos son ideales para utilizarse en tuercas pulidas, tuercas de aluminio y tuercas con puntas gastadas.

12410M (mm)	D ₁ (mm)	D ₂ (mm)	H (mm)	L (mm)	(g)	(pcs.)	⊕
6	10	13	5	23	14	10	*1
7	11.3	13	5	23	15	10	*1
8	12.5	13	6	23	15	10	*1
9	13.8	13	7	23	14	10	*1
10	15	13	7	23	14	10	*1
11	16.3	13	8	23	17	10	*1
12	17.5	13	8	23	19	10	*1
13	18.8	13	8	23	19	10	*1

*1 Pin/O-Ring=1200A/B → P255

12465M (mm)	D ₁ (mm)	D ₂ (mm)	H (mm)	L (mm)	(g)	(pcs.)	
10	15	13	8	23	17	10	*1
11	16.3	13	8	23	18	10	*1
12	17.5	13	9	23	18	10	*1
13	18.8	13	9	23	20	10	*1

*1 Pin/O-Ring=1200A/B → P255



PATHFINDER®

12465M Pathfinder Sockets Vasos Pathfinder (Guía)

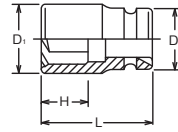

12425 (E)	D ₁ (mm)	D ₂ (mm)	H (mm)	L (mm)	(g)	(pcs.)	
E 4	6.6	13	4.6	23	14	10	*1
E 5	7.7	13	5.2	23	15	10	*1
E 6	8.7	13	5.4	23	15	10	*1
E 7	9.2	13	6.6	23	15	10	*1
E 8	9.7	13	7	23	15	10	*1
E10	12.2	13	8.2	23	15	10	*1

*1 Pin/O-Ring=1200A/B → P255

12425 TORX® Sockets Vasos TORX®

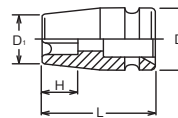

TORX® (E)

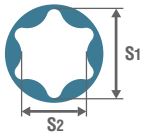

E	E4	E5	E6	E7	E8	E10	E11	E12	E14	E16	E18	E20	E22	E24	E26	E28	E30	E32
S ₁ (ref. mm)	3.7	4.6	5.6	6.1	7.4	9.3	9.9	11.0	12.8	14.6	16.5	18.3	20.1	22.0	23.7	25.5	27.3	29.0
S ₂ (ref. mm)	2.7	3.3	4.0	4.3	5.3	6.8	7.1	7.9	9.2	10.5	11.9	13.2	14.8	15.7	17.5	18.3	20.0	21.3

12460M (mm)	D ₁ (mm)	D ₂ (mm)	H (mm)	L (mm)	(g)	(pcs.)	
5.5	9.7	13	4	23	15	10	*1
6	10.3	13	5	23	15	10	*1
7	11.6	13	5	23	16	10	*1
8	12.8	13	6	23	16	10	*1
10	15.3	13	7	23	19	10	*1
13	19.1	13	8	23	23	10	*1

*1 Pin/O-Ring=1200A/B → P255

12460A (inch)	D ₁ (mm)	D ₂ (mm)	H (mm)	L (mm)	(g)	(pcs.)	
1/4	10.3	13	5	23	15	10	*1
5/16	12.8	13	6	23	16	10	*1
3/8	15.3	13	7	23	19	10	*1
1/2	19.1	13	8	23	23	10	*1

12460M • 12460A

Sockets for Self-Tapping Screws Vasos con Imán para Tornillos Autorroscantes

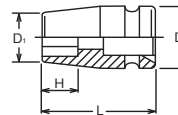

12460MG (mm)	D ₁ (mm)	D ₂ (mm)	H (mm)	L (mm)	(g)	(pcs.)	
5.5	9.7	13	2.1	23	16	10	*1
6	10.3	13	2.4	23	16	10	*1
7	11.6	13	2.8	23	16	10	*1
8	12.8	13	3.5	25	18	10	*1
10	15.3	13	4.2	28	20	10	*1
12	17.9	13	8	30	41	10	*1
13	19.1	13	6	30	23	10	*1
14	20	13	6.4	30	24	10	*1

*1 Pin/O-Ring=1200A/B → P255

12460MG • 12460AG With Magnet for Self-Tapping Screws Con Imán para Tornillos Autorroscantes

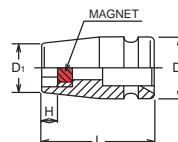

12460AG (inch)	D ₁ (mm)	D ₂ (mm)	H (mm)	L (mm)	(g)	(pcs.)	
1/4	10.3	13	2.4	23	16	10	*1
5/16	12.8	13	3.5	25	18	10	*1
3/8	15.3	13	4.2	28	20	10	*1
7/16	16.6	13	4.9	29	27	10	*1
1/2	19.1	13	6	30	23	10	*1

Impact Sockets 1/4"

Z-SERIES
HAND MANUALES
TITANIUM DE TITANIO
ACCESSORIES ACCESORIOS
IMPACT DE IMPACTO
SLEEVE-DRIVE
INDUSTRIAL INDUSTRIALES
PROTECTOR PROTECTORES
AUTOMOTIVE
CONSTRUCTION CONSTRUCCIÓN
RENEWAL KITS JUEGOS DE PIEZAS REPUÉSTO

12300M 6-point Sockets, Deep Vasos Hexagonales Largos



12300M (mm)	D ₁ (mm)	D ₂ (mm)	H ₁ (mm)	H ₂ (mm)	L (mm)	(g)	(pcs.)	
6	10	13	6	38	48	26	10	*1
7	11.3	13	7	38	48	30	10	*1
8	12.5	13	8	38	48	32	10	*1
10	15	13	10	37	48	34	10	*1
11	16.3	13	11	37	48	46	10	*1
12	17.5	13	12	37	48	49	10	*1
13	18.8	13	13	37	48	52	10	*1
14	20	13	14	36	48	57	10	*1

*1 Pin/O-Ring=1200A/B → P255

12365M Pathfinder Sockets, Deep Vasos Pathfinder (Guía) Largos



12365M (mm)	D ₁ (mm)	D ₂ (mm)	H ₁ (mm)	H ₂ (mm)	L (mm)	(g)	(pcs.)	
10	15	13	8	37	48	34	10	*1
11	16.3	13	8	37	48	46	10	*1
12	17.5	13	9	37	48	49	10	*1
13	18.8	13	9	37	48	52	10	*1

*1 Pin/O-Ring=1200A/B → P255

12300G Impact Socket with Sliding Magnet Vasos de Impacto con Imán Corredizo

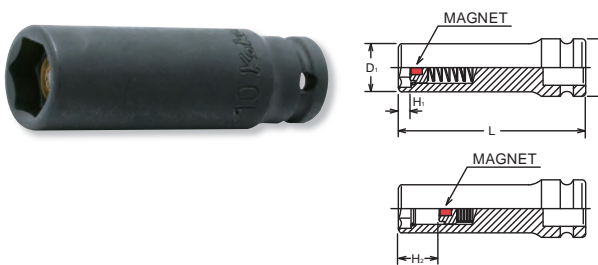

12300G (mm)	D ₁ (mm)	D ₂ (mm)	H ₁ (mm)	H ₂ (mm)	L (mm)	(g)	(pcs.)	
8	12.5	13	4	22	48	32	10	*1
10	15	13	4.5	20.5	48	34	10	*1
12	17.5	13	6	24.5	48	49	10	*1
13	18.8	13	6.5	23	48	52	10	*1
14	20	13	7	21	48	57	10	*1

*1 Pin/O-Ring=1200A/B → P255

12760 Extension Bars Alargaderas

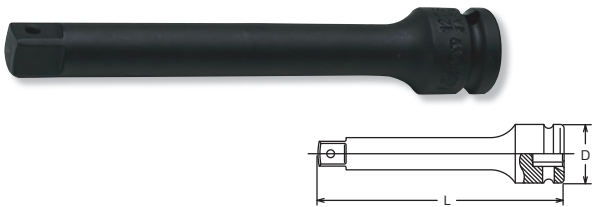

12760	D (mm)	L (mm)	(g)	(pcs.)	
55	13	55	26	10	*1
75	13	75	45	10	*1
100	13	100	50	10	*1
150	13	150	60	10	*1

*1 Pin/O-Ring=1200A/B → P255

12222AL Adaptor (Quick Release) Adaptador (Extracción Rápida)

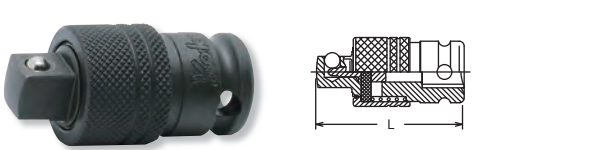

12222AL	L (mm)	(g)	(pcs.)	
12222AL	35	30	10	*1

*1 Pin/O-Ring=1200A/B → P255

Lock & Quick Release

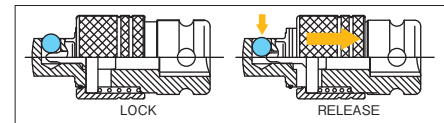

⚠ You may not hold the sliding part while moving to avoid heating up by friction and reduction by wear.

12770 Universal Joint Articulación Universal

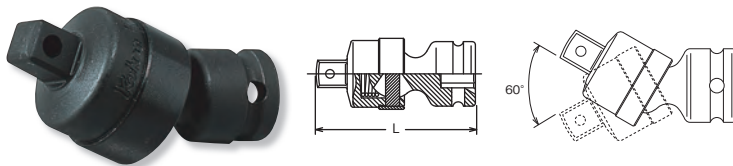

12770	L (mm)	(g)	(pcs.)	
12770	39	30	10	*1

*1 Pin/O-Ring=1200A/B → P255

12233A Adaptor Adaptador



12233A	(sq.)	(sq.)	L (mm)	(g)	(pcs.)	
12233A	1/4"	3/8"	22	15	10	*1
12233A-B	1/4"	3/8"	22	15	10	*1
12233A-P	1/4"	3/8"	22	15	10	*1

*1 Pin/O-Ring=1200A/B → P255

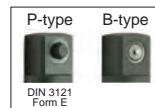



13400M · 13400A

6-point Sockets
Vasos Hexagonales

13400M (mm)	D ₁ (mm)	D ₂ (mm)	H (mm)	L (mm)	(g)	(pcs.)	
6	10.8	19	5	32	40	10	*1
7	12	19	5	32	40	10	*1
8	13.3	19	6	32	40	10	*1
9	14.5	19	7	32	40	10	*1
10	15.8	19	7	32	40	10	*1
11	17	19	8	32	41	10	*1
12	18.3	19	9	32	43	10	*1
13	19.5	22	10	32	56	10	*2
14	20.8	22	10	32	56	10	*2
15	22	22	11	32	56	10	*2
16	23.3	22	11	32	57	10	*2
17	24.5	22	12	32	60	10	*2
18	25.8	22	12	32	62	10	*2
19	27	22	12	32	67	10	*2
20	28.3	22	12	32	70	10	*2
21	29.5	22	12	32	71	10	*2
22	30.8	22	13	32	72	10	*2
23	32	22	13	32	75	10	*2
24	33.3	22	13	32	78	10	*2

*1 C-Ring=1301C, Pin/O-Ring=1301A/B
*2 C-Ring=1302C, Pin/O-Ring=1302A/B

→ P254-255

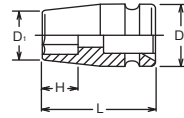

13400A (inch)	D ₁ (mm)	D ₂ (mm)	H (mm)	L (mm)	(g)	(pcs.)	
1/4	10.8	19	5	32	40	10	*1
5/16	13.3	19	6	32	40	10	*1
3/8	15.8	19	7	32	40	10	*1
7/16	17	19	8	32	41	10	*1
1/2	19.5	22	10	32	56	10	*2
9/16	20.8	22	10	32	56	10	*2
5/8	23.3	22	11	32	57	10	*2
11/16	24.5	22	12	32	60	10	*2
3/4	27	22	12	32	67	10	*2
13/16	29.5	22	12	32	71	10	*2
7/8	30.8	22	13	32	72	10	*2

*1 C-Ring=1301C, Pin/O-Ring=1301A/B
*2 C-Ring=1302C, Pin/O-Ring=1302A/B

→ P254-255

13405M · 13405A

12-point Sockets
Vasos Bihexagonales

13405M (mm)	D ₁ (mm)	D ₂ (mm)	H (mm)	L (mm)	(g)	(pcs.)	
8	13.3	19	6	32	40	10	*1
9	14.5	19	7	32	40	10	*1
10	15.8	19	7	32	40	10	*1
11	17	19	8	32	41	10	*1
12	18.3	19	9	32	43	10	*1
13	19.5	22	10	32	56	10	*2
14	20.8	22	10	32	56	10	*2
15	22	22	11	32	56	10	*2
16	23.3	22	11	32	57	10	*2
17	24.5	22	12	32	60	10	*2
18	25.8	22	12	32	62	10	*2
19	27	22	12	32	67	10	*2

*1 C-Ring=1301C, Pin/O-Ring=1301A/B
*2 C-Ring=1302C, Pin/O-Ring=1302A/B

→ P254-255

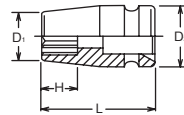

13405A (inch)	D ₁ (mm)	D ₂ (mm)	H (mm)	L (mm)	(g)	(pcs.)	
1/4	10.8	19	5	32	40	10	*1
5/16	13.3	19	6	32	40	10	*1
3/8	15.8	19	7	32	40	10	*1
7/16	17	19	8	32	41	10	*1
1/2	19.5	22	10	32	56	10	*2
9/16	20.8	22	10	32	56	10	*2
5/8	23.3	22	11	32	57	10	*2
11/16	24.5	22	12	32	60	10	*2
3/4	27	22	12	32	67	10	*2
13/16	29.5	22	12	32	71	10	*2
7/8	30.8	22	13	32	72	10	*2

*1 C-Ring=1301C, Pin/O-Ring=1301A/B
*2 C-Ring=1302C, Pin/O-Ring=1302A/B

→ P254-255

13400MG · 13400AG

6-point Sockets with Magnet
Vasos Hexagonales con Imán

13400MG (mm)	D ₁ (mm)	D ₂ (mm)	H (mm)	L (mm)	(g)	(pcs.)	
6	10.8	19	2.4	32	46	10	*1
7	12	19	2.8	32	45	10	*1
8	13.3	19	3.5	32	45	10	*1
9	14.5	19	3.8	32	44	10	*1
10	15.8	19	4.2	32	49	10	*1
11	17	19	4.9	32	50	10	*1
12	18.3	19	5.6	32	55	10	*1
13	19.5	22	6	32	70	10	*2
14	20.8	22	6.4	32	76	10	*2
15	22	22	6.8	32	76	10	*2
16	23.3	22	7	32	88	10	*2
17	24.5	22	7.5	32	95	10	*2
18	25.8	22	7.8	32	105	10	*2
19	27	22	8	32	116	10	*2
21	29.5	22	8	32	125	10	*2
22	30.8	22	9.5	32	135	10	*2

*1 C-Ring=1301C, Pin/O-Ring=1301A/B
*2 C-Ring=1302C, Pin/O-Ring=1302A/B

→ P254-255

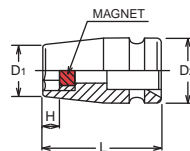

13400AG (inch)	D ₁ (mm)	D ₂ (mm)	H (mm)	L (mm)	(g)	(pcs.)	
1/4	10.8	19	2.4	32	46	10	*1
5/16	13.3	19	3.5	32	45	10	*1
11/32	14.5	19	3.8	32	44	10	*1
3/8	15.8	19	4.2	32	49	10	*1
7/16	17	19	4.9	32	50	10	*1
1/2	19.5	22	6	32	70	10	*2
9/16	20.8	22	6.4	32	76	10	*2
5/8	23.3	22	7	32	88	10	*2
11/16	24.5	22	7.5	32	95	10	*2
3/4	27	22	8	32	116	10	*2

*1 C-Ring=1301C, Pin/O-Ring=1301A/B
*2 C-Ring=1302C, Pin/O-Ring=1302A/B

→ P254-255

Impact Sockets **3/8"**

Z-SERIES
HAND MANUALES
TITANIUM DE TITANIO
ACCESSORIES ACCESORIOS
SCREWDRIVERS DESTORNILLADORES
IMPACT DE IMPACTO
SLEEVE-DRIVE
INDUSTRIAL INDUSTRIALES
PROTECTOR PROTECTORES
AUTOMOTIVE
CONSTRUCTION CONSTRUCCIÓN
RENEWAL KITS JUEGOS DE PIEZAS/REPUUESTO

13401M • 13401A

6-point Socket, Thin Walled
Vasos Hexagonales de Pared Delgada

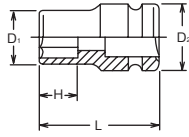

13401A (inch)	D ₁ (mm)	D ₂ (mm)	H (mm)	L (mm)	(g)	(pcs.)	
1/4	9.8	18.5	5	32	28	10	*1
5/16	12.3	18.5	6	32	31	10	*1
3/8	14.8	18.5	7	32	34	10	*1
7/16	16	18.5	8	32	35	10	*1
1/2	18.5	21.5	10	32	43	10	*2
9/16	19.8	21.5	10	32	49	10	*2
5/8	22.3	21.5	11	32	51	10	*2
11/16	23.5	21.5	12	32	54	10	*2
3/4	26	21.5	12	32	60	10	*2
13/16	28.5	21.5	12	32	70	10	*2
7/8	29.8	21.5	13	32	73	10	*2

*1 C-Ring=1301C, Pin/O-Ring=1301A/B
*2 C-Ring=1302C, Pin/O-Ring=1302A/B

13401M (mm)	D ₁ (mm)	D ₂ (mm)	H (mm)	L (mm)	(g)	(pcs.)	
6	9.8	18.5	5	32	28	10	*1
7	11	18.5	5	32	30	10	*1
8	12.3	18.5	6	32	31	10	*1
9	13.5	18.5	7	32	32	10	*1
10	14.8	18.5	7	32	34	10	*1
11	16	18.5	8	32	35	10	*1
12	17.3	18.5	9	32	36	10	*1
13	18.5	21.5	10	32	43	10	*2
14	19.8	21.5	10	32	49	10	*2
15	21	21.5	11	32	49	10	*2
16	22.3	21.5	11	32	51	10	*2
17	23.5	21.5	12	32	54	10	*2
18	24.8	21.5	12	32	57	10	*2
19	26	21.5	12	32	60	10	*2
20	27.3	21.5	12	32	65	10	*2
21	28.5	21.5	12	32	70	10	*2
22	29.8	21.5	13	32	73	10	*2
23	31	21.5	13	32	73	10	*2
24	32.3	21.5	13	32	75	10	*2

*1 C-Ring=1301C, Pin/O-Ring=1301A/B
*2 C-Ring=1302C, Pin/O-Ring=1302A/B

RS13401M/9

Socket Set on Rail
Juego de Vasos en Regleta



RS13401M/9	9 Pieces Set/Rail 250mm	(g)
8, 10, 12, 13, 14, 17, 19, 21, 22		505

13406M • 13406A

12-point Socket, Thin Walled
Vasos Bihexagonales de Pared Delgada

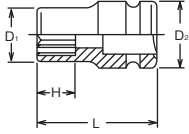

13406A (inch)	D ₁ (mm)	D ₂ (mm)	H (mm)	L (mm)	(g)	(pcs.)	
1/4	9.8	18.5	5	32	28	10	*1
5/16	12.3	18.5	6	32	31	10	*1
3/8	14.8	18.5	7	32	34	10	*1
7/16	16	18.5	8	32	35	10	*1
1/2	18.5	21.5	10	32	43	10	*2
9/16	19.8	21.5	10	32	49	10	*2
5/8	22.3	21.5	11	32	51	10	*2
11/16	23.5	21.5	12	32	54	10	*2
3/4	26	21.5	12	32	60	10	*2
13/16	28.5	21.5	12	32	70	10	*2
7/8	29.8	21.5	13	32	73	10	*2

*1 C-Ring=1301C, Pin/O-Ring=1301A/B
*2 C-Ring=1302C, Pin/O-Ring=1302A/B

13406M (mm)	D ₁ (mm)	D ₂ (mm)	H (mm)	L (mm)	(g)	(pcs.)	
6	9.8	18.5	5	32	28	10	*1
7	11	18.5	5	32	30	10	*1
8	12.3	18.5	6	32	31	10	*1
9	13.5	18.5	7	32	32	10	*1
10	14.8	18.5	7	32	34	10	*1
11	16	18.5	8	32	35	10	*1
12	17.3	18.5	9	32	36	10	*1
13	18.5	21.5	10	32	43	10	*2
14	19.8	21.5	10	32	49	10	*2
15	21	21.5	11	32	49	10	*2
16	22.3	21.5	11	32	51	10	*2
17	23.5	21.5	12	32	54	10	*2
18	24.8	21.5	12	32	57	10	*2
19	26	21.5	12	32	60	10	*2
20	27.3	21.5	12	32	65	10	*2
21	28.5	21.5	12	32	70	10	*2
22	29.8	21.5	13	32	73	10	*2
23	31	21.5	13	32	73	10	*2
24	32.3	21.5	13	32	75	10	*2

*1 C-Ring=1301C, Pin/O-Ring=1301A/B
*2 C-Ring=1302C, Pin/O-Ring=1302A/B

13401MS

6-point Short Sockets, Thin-walled.
Vasos Hexagonales de Pared Delgada, Short

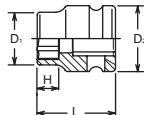

RS13401MS/5

Socket Set on Rail
Juego de Vasos en Regleta



13401MS (mm)	D ₁ (mm)	D ₂ (mm)	H (mm)	L (mm)	(g)	(pcs.)	
8	12.3	18.5	6	22	25	10	*1
10	14.8	18.5	6	22	25	10	*1
12	17.3	18.5	10	22	20	10	*1
13	18.5	21.5	10	22	30	10	*2
14	19.8	21.5	10	22	30	10	*2

*1 C-Ring=1301C, Pin/O-Ring=1301A/B
*2 C-Ring=1302C, Pin/O-Ring=1302A/B

RS13401MS/5	5 Pieces Set/Rail 150mm	(g)
8, 10, 12, 13, 14		180

13410M (mm)	D ₁ (mm)	D ₂ (mm)	H (mm)	L (mm)	(g)	(pcs.)	
6	10.8	19	5	32	40	10	*1
7	12	19	5	32	40	10	*1
8	13.3	19	6	32	40	10	*1
9	14.5	19	7	32	40	10	*1
10	15.8	19	7	32	40	10	*1
11	17	19	8	32	42	10	*1
12	18.3	19	9	32	50	10	*1
13	19.5	22	10	32	56	10	*2
14	20.8	22	10	32	56	10	*2
15	22	22	11	32	56	10	*2
16	23.3	22	11	32	57	10	*2
17	24.5	22	12	32	60	10	*2
18	25.8	22	12	32	62	10	*2
19	27	22	12	32	67	10	*2
22	30.8	22	13	32	72	10	*2

*1 C-Ring=1301C, Pin/O-Ring=1301A/B

*2 C-Ring=1302C, Pin/O-Ring=1302A/B 

13465M (mm)	D ₁ (mm)	D ₂ (mm)	H (mm)	L (mm)	(g)	(pcs.)	
8	13.3	19	8	32	40	10	*1
10	15.8	19	8	32	43	10	*1
11	17	19	8	32	44	10	*1
12	18.3	19	9	32	47	10	*1
13	19.5	22	9	32	55	10	*2
14	20.8	22	11	32	56	10	*2
15	22	22	11	32	56	10	*2
16	23.3	22	11	32	57	10	*2
17	24.5	22	12	32	60	10	*2
18	25.8	22	13	32	63	10	*2
19	27	22	13	32	66	10	*2

*1 C-Ring=1301C, Pin/O-Ring=1301A/B

*2 C-Ring=1302C, Pin/O-Ring=1302A/B 

13425 (E)	D ₁ (mm)	D ₂ (mm)	H (mm)	L (mm)	(g)	(pcs.)	
E 4	9.7	19	4.6	32	44	10	*1
E 5	10.2	19	5.2	32	43	10	*1
E 6	10.7	19	5.4	32	44	10	*1
E 7	11.2	19	6.6	32	44	10	*1
E 8	11.7	19	7	32	44	10	*1
E10	12.2	19	8.2	32	42	10	*1
E12	14.2	19	9.3	32	43	10	*1
E14	17.2	19	10.6	32	44	10	*1
E16	18.2	19	11.8	32	42	10	*1

*1 C-Ring=1301C, Pin/O-Ring=1301A/B 

TORX® (E)

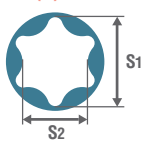

E	E4	E5	E6	E7	E8	E10	E11	E12	E14	E16	E18	E20	E22	E24	E26	E28	E30	E32
S ₁ (ref. mm)	3.7	4.6	5.6	6.1	7.4	9.3	9.9	11.0	12.8	14.6	16.5	18.3	20.1	22.0	23.7	25.5	27.3	29.0
S ₂ (ref. mm)	2.7	3.3	4.0	4.3	5.3	6.8	7.1	7.9	9.2	10.5	11.9	13.2	14.8	15.7	17.5	18.3	20.0	21.3

13425-EPL (EPL)	D ₁ (mm)	D ₂ (mm)	H (mm)	L (mm)	(g)	(pcs.)	
8EPL	12	19	5.2	32	44	10	*1
10EPL	13.3	19	6.2	32	44	10	*1
12EPL	15.8	19	7.2	32	44	10	*1
14EPL	18.3	19	8.1	32	46	10	*1
16EPL	19.5	19	9.2	32	41	10	*1

*1 C-Ring=1301C, Pin/O-Ring=1301A/B 

TORXplus® (EP/EPL)

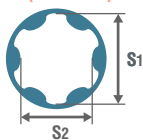

EP/EPL	8EP	10EP	12EP	14EP	16EP	18EP	20EP	22EP	24EP	26EP	28EP	30EP	32EP
S ₁ (ref. mm)	7.4	9.3	11.0	12.8	14.6	16.5	18.3	20.1	22.0	23.7	25.5	27.3	29.0
S ₂ (ref. mm)	5.3	6.8	7.9	9.2	10.5	11.9	13.2	14.8	15.7	17.5	18.3	20.0	21.3

13410M Surface Drive Sockets Vasos Surface Drive (de Contacto Curvo)



SURFACE DRIVE

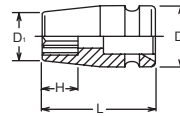

13465M Pathfinder Sockets Vasos Pathfinder (Guía)



PATHFINDER®

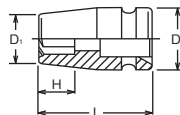

13425 TORX® Sockets Vasos TORX®

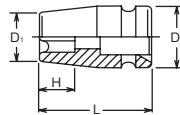

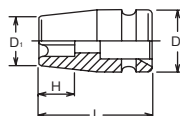

13425-EPL TORXPLUS® Sockets Vasos TORXPLUS®

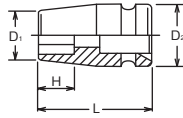

Z-SERIES
HAND MANUALES
TITANIUM DE TITANIO
SCREWDRIVERS ACCESORIOS DESTORNILLADORES ACCESORIOS
IMPACT DE IMPACTO
SLEEVE-DRIVE
INDUSTRIAL INDUSTRIALES
PROTECTOR PROTECTORES
AUTOMOTIVE
CONSTRUCTION CONSTRUCCIÓN
RENEWAL KITS JUEGOS DE PIEZAS REPUESTO

13460M • 13460A For Self-Tapping Screws Para Tornillos Autorroscantes





13460M (mm)	D ₁ (mm)	D ₂ (mm)	H (mm)	L (mm)	(g)	(pcs.)	
6	11.4	19	5	32	43	10	*1
7	12.8	19	5	32	44	10	*1
8	14.1	19	6	32	44	10	*1
10	16.6	19	7	32	45	10	*1
12	19	19.2	9	32	48	10	*2
13	20.3	22	10	32	60	10	*2

13460A (inch)	D ₁ (mm)	D ₂ (mm)	H (mm)	L (mm)	(g)	(pcs.)	
1/4	11.4	19	5	32	43	10	*1
3/8	16.6	19	7	32	45	10	*1
1/2	20.3	22	10	32	60	10	*2

*1 C-Ring=1301C, Pin/O-Ring=1301A/B → P254-255
*2 C-Ring=1302C, Pin/O-Ring=1302A/B

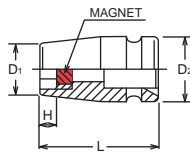
13460MG • 13460AG Sockets with Magnets for Self-Tapping Screws Vasos con Imán para Tornillos Autorroscantes





13460MG (mm)	D ₁ (mm)	D ₂ (mm)	H (mm)	L (mm)	(g)	(pcs.)	
6	11.4	19	2.4	32	44	10	*1
7	12.8	19	2.8	32	46	10	*1
8	14.1	19	3.5	32	48	10	*1
10	16.6	19	4.2	33	54	10	*1
13	20.3	22	6	34	81	10	*2

13460AG (inch)	D ₁ (mm)	D ₂ (mm)	H (mm)	L (mm)	(g)	(pcs.)	
1/4	11.4	19	2.4	32	44	10	*1
5/16	14.1	19	3.5	32	48	10	*1
3/8	16.6	19	4.2	33	54	10	*1
1/2	20.3	22	6	34	81	10	*2

*1 C-Ring=1301C, Pin/O-Ring=1301A/B → P254-255
*2 C-Ring=1302C, Pin/O-Ring=1302A/B

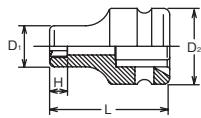
13401LH LHS Sockets Vasos LHS



13401LH (LH-S)	D ₁ (mm)	D ₂ (mm)	H (mm)	L (mm)	(g)	(pcs.)	
5S	11	19	5	32	32	10	*1
6S	12.3	19	5.6	32	34	10	*1
8S	16	19	6.8	32	36	10	*1
10S	18.5	22	8	32	50	10	*2
12S	22.3	22	9.2	32	58	10	*2
14S	24.8	22	10.4	32	63	10	*2
16S	28.5	22	11.6	32	77	10	*2

*1 C-Ring=1301C, Pin/O-Ring=1301A/B → P254-255
*2 C-Ring=1302C, Pin/O-Ring=1302A/B

LHSTIX®

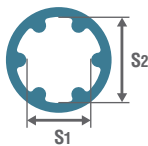

LH-S		LH-5S	LH-6S	LH-8S	LH-10S	LH-12S	LH-14S	LH-16S
S ₁	(ref. mm)	5.6	6.8	9.0	11.3	13.6	15.8	18.1
S ₂	(ref. mm)	7.5	9.0	12.0	15.0	18.0	21.0	24.0

13400-WN Weld Nut Sockets

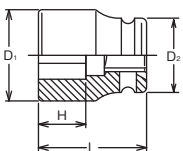

13400-WN	D ₁ (mm)	D ₂ (mm)	H (mm)	L (mm)	(g)	(pcs.)	
6WN	15.8	19	6	32	48	10	*1
8WN	18.3	19	8	32	48	10	*1
9WN	19.5	22	9	32	47	10	*2
10WN	20.8	22	10	32	65	10	*2
12WN	24.5	22	12	32	73	10	*2
14WN	27	22	14	32	79	10	*2
17WN	32	22	17	35	110	10	*2

*1 C-Ring=1301C, Pin/O-Ring=1301A/B → P254-255
*2 C-Ring=1302C, Pin/O-Ring=1302A/B

WN



WN		6WN	8WN	9WN	10WN	12WN	14WN	17WN
S	(ref. mm)	6	8	9	10	12	14	17

13301X (mm)	D ₁ (mm)	D ₂ (mm)	H ₁ (mm)	H ₂ (mm)	L (mm)	(g)	(pcs.)	
7	11	18.5	7	36.5	50	40	10	*1
8	12.3	18.5	8	36.5	50	40	10	*1
10	14.8	18.5	10	36.5	50	46	10	*1
11	16	18.5	11	36.5	50	49	10	*1
12	17.3	18.5	12	36.5	50	53	10	*1
13	18.5	21.5	13	36.5	50	67	10	*2
14	19.8	21.5	14	36.5	50	70	10	*2
15	21	21.5	15	35.5	50	75	10	*2
16	22.3	21.5	16	35.5	50	78	10	*2
17	23.5	21.5	17	35.5	50	82	10	*2
18	24.8	21.5	18	34.5	50	86	10	*2
19	26	21.5	19	34.5	50	93	10	*2
21	28.5	21.5	21	34.5	50	104	10	*2
22	29.8	21.5	22	33.5	50	110	10	*2
23	31	21.5	23	33.5	50	115	10	*2
24	32.3	21.5	24	32.5	50	120	10	*2

*1 C-Ring=1301C, Pin/O-Ring=1301A/B

*2 C-Ring=1302C, Pin/O-Ring=1302A/B

→ P254-255

RS13301X/9	9 Pieces Set/Rail 250mm	(g)
8, 10, 12, 13, 14, 17, 19, 21, 22		710



FLAT DRIVE®

13301X 6-point Sockets, Semi-Deep Vasos Hexagonales Medianos de Pared Delgada

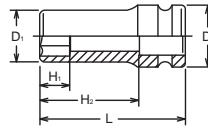

RS13301X/9 Socket Set on Rail Juego de Vasos en Regleta



13300XG (mm)	D ₁ (mm)	D ₂ (mm)	H ₁ (mm)	H ₂ (mm)	L (mm)	(g)	(pcs.)	
7	12	19	3.5	19	50	52	10	*1
8	13.3	19	4	20.5	50	40	10	*1
10	15.8	19	4.5	20	50	46	10	*1
11	17	19	5	20	50	50	10	*1
12	18.3	19	6	20	50	55	10	*1
13	19.5	22	6.5	19	50	70	10	*2
14	20.8	22	7	18	50	75	10	*2
16	23.2	22	7.5	20	50	114	10	*2
17	24.4	22	8	20	50	126	10	*2

*1 C-Ring=1301C, Pin/O-Ring=1301A/B

*2 C-Ring=1302C, Pin/O-Ring=1302A/B

→ P254-255



SLIDE MAGNET

13300XG Impact Sockets with Sliding Magnet Vasos de Impacto con Imán Corredizo

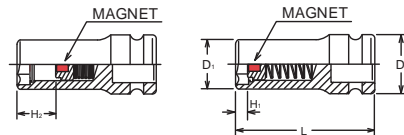

13300M · 13300A 6-point Sockets, Deep Vasos Hexagonales Largos

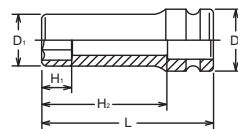

13300M (mm)	D ₁ (mm)	D ₂ (mm)	H ₁ (mm)	H ₂ (mm)	L (mm)	(g)	(pcs.)	
6	10.8	19	6	66.5	80	77	10	*1
7	12	19	7	66.5	80	82	10	*1
8	13.3	19	8	66.5	80	82	10	*1
9	14.5	19	9	66.5	80	88	10	*1
10	15.8	19	10	66.5	80	94	10	*1
11	17	19	11	66.5	80	110	10	*1
12	18.3	19	12	66.5	80	111	10	*1
13	19.5	22	13	66.5	80	138	10	*2
14	20.8	22	14	66.5	80	148	10	*2
15	22	22	15	65.5	80	157	10	*2
16	23.3	22	16	65.5	80	156	10	*2
17	24.5	22	17	65.5	80	168	10	*2
18	25.8	22	18	64.5	80	190	10	*2
19	27	22	19	64.5	80	192	10	*2
20	28.3	22	20	64.5	80	224	10	*2
21	29.5	22	21	64.5	80	226	10	*2
22	30.8	22	22	63.5	80	231	10	*2
24	33.2	22	24	63.5	80	242	10	*2

*1 C-Ring=1301C, Pin/O-Ring=1301A/B

*2 C-Ring=1302C, Pin/O-Ring=1302A/B

→ P254-255

13300A (inch)	D ₁ (mm)	D ₂ (mm)	H ₁ (mm)	H ₂ (mm)	L (mm)	(g)	(pcs.)	
1/4	10.8	19	6	66.5	80	77	10	*1
5/16	13.3	19	8	66.5	80	82	10	*1
3/8	15.8	19	10	66.5	80	94	10	*1
7/16	17	19	11	66.5	80	110	10	*1
1/2	19.5	22	13	66.5	80	138	10	*2
9/16	20.8	22	14	66.5	80	148	10	*2
5/8	23.3	22	16	65.5	80	156	10	*2
11/16	24.5	22	17	65.5	80	168	10	*2
3/4	27	22	19	64.5	80	192	10	*2
13/16	29.5	22	21	64.5	80	226	10	*2
7/8	30.8	22	22	63.5	80	231	10	*2

*1 C-Ring=1301C, Pin/O-Ring=1301A/B

*2 C-Ring=1302C, Pin/O-Ring=1302A/B

→ P254-255

Z-SERIES
HAND
MANUALES
TITANIUM
DE TITANIO
ACCESSORIES
ACCESORIOS
SCREWDRIVERS
DESTORNILLADORES
IMPACT
DE IMPACTO
SLEEVE-DRIVE
INDUSTRIAL
INDUSTRIALES
PROTECTOR
PROTECTORES
AUTOMOTIVE
CONSTRUCTION
CONSTRUCCION
RENEWAL KITS
JUEGOS DE HERRAMIENTAS

Impact Sockets **3/8"**

Z-SERIES
HAND MANUALES
TITANIUM DE TITANIO
ACCESSORIES ACCESORIOS
IMPACT DE IMPACTO
SLEEVE-DRIVE
INDUSTRIAL INDUSTRIALES
PROTECTOR PROTECTORES
AUTOMOTIVE
CONSTRUCTION CONSTRUCCIÓN
RENEWAL KITS JUEGOS DE PIEZAS REPUES TO

13301M • 13301A 6-point Deep Sockets, Thin Walled Vasos Hexagonales Largos de Pared Delgada

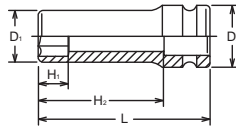

13301M (mm)	D ₁ (mm)	D ₂ (mm)	H ₁ (mm)	H ₂ (mm)	L (mm)	⚖️ (g)	📦 (pcs.)	⚡
6	10	18.5	6	66.5	80	65	10	*1
7	11	18.5	7	66.5	80	66	10	*1
8	12.3	18.5	8	66.5	80	68	10	*1
9	13.5	18.5	9	66.5	80	70	10	*1
10	14.8	18.5	10	66.5	80	72	10	*1
11	16	18.5	11	66.5	80	80	10	*1
12	17.3	18.5	12	66.5	80	85	10	*1
13	18.5	21.5	13	66.5	80	100	10	*2
14	19.8	21.5	14	66.5	80	110	10	*2
15	21	21.5	15	65.5	80	120	10	*2
16	22.3	21.5	16	65.5	80	130	10	*2
17	23.5	21.5	17	65.5	80	136	10	*2
18	24.8	21.5	18	64.5	80	145	10	*2
19	26	21.5	19	64.5	80	155	10	*2
20	27.3	21.5	20	64.5	80	170	10	*2
21	28.5	21.5	21	64.5	80	181	10	*2
22	29.8	21.5	22	63.5	80	190	10	*2
24	32.3	21.5	24	63.5	80	216	10	*2

13305M 12-point Sockets, Deep Vasos Bihexagonales Largos

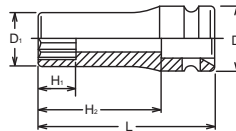

13301A (inch)	D ₁ (mm)	D ₂ (mm)	H ₁ (mm)	H ₂ (mm)	L (mm)	⚖️ (g)	📦 (pcs.)	⚡
1/4	10	18.5	6	66.5	80	65	10	*1
5/16	12.3	18.5	8	66.5	80	68	10	*1
3/8	14.8	18.5	10	66.5	80	72	10	*1
7/16	16	18.5	11	66.5	80	80	10	*1
1/2	18.5	21.5	13	66.5	80	100	10	*2
9/16	19.8	21.5	14	66.5	80	110	10	*2
5/8	22.3	21.5	16	65.5	80	130	10	*2
11/16	23.5	21.5	17	65.5	80	136	10	*2
3/4	26	21.5	19	64.5	80	155	10	*2
13/16	28.5	21.5	21	64.5	80	181	10	*2
7/8	29.8	21.5	22	63.5	80	190	10	*2

*1 C-Ring=1301C, Pin/O-Ring=1301A/B → P254-255
*2 C-Ring=1302C, Pin/O-Ring=1302A/B

13306M 12-point Deep Sockets, Thin-Walled Vasos Bihexagonales Largos de Pared Delgada

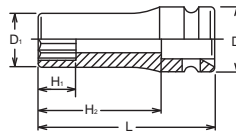

13305M (mm)	D ₁ (mm)	D ₂ (mm)	H ₁ (mm)	H ₂ (mm)	L (mm)	⚖️ (g)	📦 (pcs.)	⚡
8	13.3	19	8	66.5	80	82	10	*1
10	15.8	19	10	66.5	80	94	10	*1
11	17	19	11	66.5	80	110	10	*1
12	18.3	19	12	66.5	80	111	10	*1
13	19.5	22	13	66.5	80	138	10	*2
14	20.8	22	14	66.5	80	148	10	*2
17	24.5	22	17	65.5	80	168	10	*2

*1 C-Ring=1301C, Pin/O-Ring=1301A/B → P254-255
*2 C-Ring=1302C, Pin/O-Ring=1302A/B

13310M Surface Drive Sockets, Deep Vasos Surface Drive (de Contacto Curvo) Largos

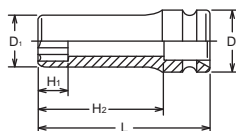

13310M (mm)	D ₁ (mm)	D ₂ (mm)	H ₁ (mm)	H ₂ (mm)	L (mm)	⚖️ (g)	📦 (pcs.)	⚡
7	12	19	7	66.5	80	77	10	*1
8	13.3	19	8	66.5	80	90	10	*1
9	14.5	19	9	66.5	80	90	10	*1
10	15.8	19	10	66.5	80	97	10	*1
11	17	19	11	66.5	80	110	10	*1
12	18.3	19	12	66.5	80	105	10	*1
13	19.5	22	13	66.5	80	135	10	*2
14	20.8	22	14	66.5	80	145	10	*2
15	22	22	15	65.5	80	160	10	*2
16	23.3	22	16	65.5	80	156	10	*2
17	24.5	22	17	65.5	80	168	10	*2
18	25.8	22	18	64.5	80	190	10	*2
19	27	22	19	64.5	80	190	10	*2

*1 C-Ring=1301C, Pin/O-Ring=1301A/B → P254-255
*2 C-Ring=1302C, Pin/O-Ring=1302A/B

13300G (mm)	D ₁ (mm)	D ₂ (mm)	H ₁ (mm)	H ₂ (mm)	L (mm)	(g)	(pcs.)	
8	13.3	19	4	26.5	80	82	10	*1
10	15.8	19	4.5	26	80	105	10	*1
12	18.3	19	6	26	80	136	10	*1
13	19.5	22	6.5	25	80	165	10	*2
14	20.8	22	7	24	80	186	10	*2
15	22	22	7	24	80	195	10	*2
16	23.3	22	8	27	80	210	10	*2
17	24.5	22	8	27	80	220	10	*2
19	27	22	9	28	80	230	10	*2

*1 C-Ring=1301C, Pin/O-Ring=1301A/B

*2 C-Ring=1302C, Pin/O-Ring=1302A/B

→ P254-255



SLIDE MAGNET

13300G Impact Sockets with Sliding Magnet

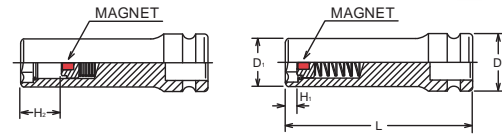

13365M (mm)	D ₁ (mm)	D ₂ (mm)	H ₁ (mm)	H ₂ (mm)	L (mm)	(g)	(pcs.)	
8	13.3	19	7	66.5	80	90	10	*1
10	15.8	19	8	66.5	80	99	10	*1
11	17	19	8	66.5	80	108	10	*1
12	18.3	19	9	66.5	80	110	10	*1
13	19.5	22	9	66.5	80	142	10	*2
14	20.8	22	11	66.5	80	144	10	*2
15	22	22	11	65.5	80	150	10	*2
16	23.3	22	11	65.5	80	159	10	*2
17	24.5	22	12	65.5	80	170	10	*2
18	25.8	22	13	64.5	80	201	10	*2
19	27	22	13	64.5	80	203	10	*2

*1 C-Ring=1301C, Pin/O-Ring=1301A/B

*2 C-Ring=1302C, Pin/O-Ring=1302A/B

→ P254-255



PATHFINDER®

13365M Pathfinder Sockets deep

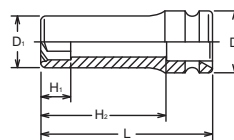

13325 (E)	D ₁ (mm)	D ₂ (mm)	H ₁ (mm)	H ₂ (mm)	L (mm)	(g)	(pcs.)	
E 7	11.2	19	6.6	66.5	80	75	10	*1
E 8	11.7	19	7	66.5	80	80	10	*1
E10	12.2	19	8.2	66.5	80	85	10	*1
E12	14.2	19	9.3	66.5	80	90	10	*1
E14	17.2	19	10.6	66.5	80	110	10	*1
E16	18.2	19	11.8	66.5	80	110	10	*1

*1 C-Ring=1301C, Pin/O-Ring=1301A/B

→ P254-255

13325 TORX® Deep Sockets

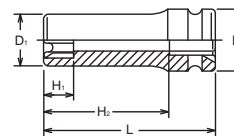

13440M (mm)	D (mm)	H (mm)	L (mm)	(g)	(pcs.)	
10	15.8	5	57	115	10	*2
11	17	6	57	115	10	*2
12	18.3	6	57	115	10	*2
13	19.5	6	57	115	10	*2
14	20.8	7	59	120	10	*2
15	22	7	59	120	10	*2
16	23.3	8	59	120	10	*2
17	24.5	8	59	120	10	*2
18	25.8	9	61	126	10	*2
19	27	10	61	130	10	*2
20	29.5	10	61	135	10	*2
21	30.7	14	66	175	10	*2
22	32	13	61	185	10	*2
24	34.5	13	63	190	10	*2

13440A (inch)	D (mm)	H (mm)	L (mm)	(g)	(pcs.)	
3/8	15.8	5	57	115	10	*2
7/16	17	6	57	115	10	*2
1/2	19.5	6	57	115	10	*2
9/16	20.8	7	59	120	10	*2
5/8	23.3	8	59	120	10	*2
11/16	24.5	8	59	120	10	*2
3/4	27	10	61	130	10	*2

*2 C-Ring=1302C, Pin/O-Ring=1302A/B

→ P254-255

13440M • 13440A Universal Sockets



13440T TORX® Universal Sockets



13430M Universal Inhex Sockets

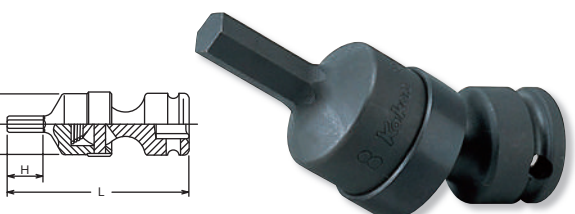

13440T (E)	D (mm)	H (mm)	L (mm)	(g)	(pcs.)	
E10	13.3	8.2	58	115	10	*2
E12	15.8	9.3	58	115	10	*2
E14	17	10.6	58	115	10	*2

*2 C-Ring=1302C, Pin/O-Ring=1302A/B

→ P254-255

13430M (mm)	D (mm)	H (mm)	L (mm)	(g)	(pcs.)	
5	24	15	74	120	10	*2
6	24	15	74	131	10	*2
8	24	20	74	136	10	*2
10	24	20	74	141	10	*2
17	24	7	53	150	10	*2

*2 C-Ring=1302C, Pin/O-Ring=1302A/B

→ P254-255

TORX is a registered trademark of Acument Intellectual Properties, LLC.
TORX es una marca registrada de Acument Intellectual Properties, LLC.

Z-SERIES
HAND
MANUALES
TITANIUM
DE TITANIO
ACCESSORIES
ACCESORIOS
DESTORNILLADORES
DE IMPACTO
SLEEVE-DRIVE
INDUSTRIAL
INDUSTRIALES
PROTECTOR
PROTECTORES
AUTOMOTIVE
CONSTRUCTION
CONSTRUCCION
RENEWAL KITS
JUEGOS DE HERRAMIENTAS

Impact Sockets **3/8"**

Z-SERIES
HAND MANUALES
TITANIUM DE TITANIO
SCREWDRIVERS ACCESSORIES DESTORNILLADORES ACCESORIOS
IMPACT DE IMPACTO
SLEEVE-DRIVE
INDUSTRIAL INDUSTRIALES
PROTECTOR PROTECTORES
AUTOMOTIVE
CONSTRUCTION CONSTRUCCION
RENEWAL KITS JUEGOS DE PIEZAS REPUES TO

13012M-52 Inhex Sockets Vasos con Punta Hexagonal

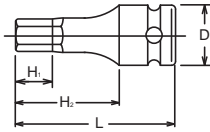



13012M.52 (mm)	D (mm)	H ₁ (mm)	H ₂ (mm)	L (mm)	(g)	(pcs.)	
3	18	10	34	52	33	10	*1
4	18	15.5	34	52	35	10	*1
5	18	15.5	34	52	35	10	*1
6	18	15.5	34	52	39	10	*1
7	18	15.5	34	52	44	10	*1
8	21	15.5	34	52	60	10	*2
10	21	15.5	34	52	70	10	*2
12	21	15.5	34	52	79	10	*2
14	21	15.5	34	52	92	10	*2

*1 C-Ring=1301C, Pin/O-Ring=1301A/B
*2 C-Ring=1302C, Pin/O-Ring=1302A/B 

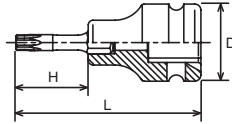
13025-50 · -90 TORX® Bit Sockets Vasos con Punta TORX®



13025.50 (T)	D (mm)	H (mm)	L (mm)	(g)	(pcs.)	
T20	19	23.5	50	35	10	*1
T25	19	23.5	50	35	10	*1
T27	19	23.5	50	35	10	*1
T30	19	23.5	50	35	10	*1
T40	19	23.5	50	39	10	*1
T45	19	23.5	50	60	10	*1
T50	19	23.5	50	70	10	*1
T55	22	23.5	50	79	10	*2

*1 C-Ring=1301C, Pin/O-Ring=1301A/B
*2 C-Ring=1302C, Pin/O-Ring=1302A/B 

13025.90 (T)	D (mm)	H (mm)	L (mm)	(g)	(pcs.)	
T20	19	63.5	90	43	10	*1
T25	19	63.5	90	45	10	*1
T27	19	63.5	90	47	10	*1
T30	19	63.5	90	50	10	*1
T40	19	63.5	90	58	10	*1
T45	19	63.5	90	66	10	*1
T50	19	63.5	90	80	10	*1
T55	22	63.5	90	120	10	*2

*1 C-Ring=1301C, Pin/O-Ring=1301A/B
*2 C-Ring=1302C, Pin/O-Ring=1302A/B 

RS13025/8-L50 Socket Set on Rail Juego de Vasos en Regleta



RS13025/8-L50	8 Pieces Set/Rail 200mm	(g)
T20, T25, T27, T30, T40, T45, T50, T55		380

13134 Impact Bit Holder Porta-punta de Impacto

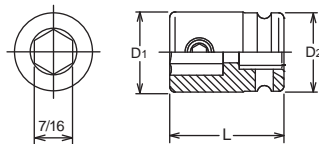

13134	D ₁ (mm)	D ₂ (mm)	L (mm)	(g)	(pcs.)	
13134	22.5	22	32	70	10	*2

*2 C-Ring=1302C, Pin/O-Ring=1302A/B 

 Replacement Screw : M8x5, ● 4mm

For
DIN3126 / ISO1173 E11.2 Bits

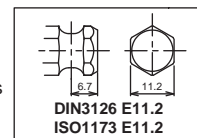

13142-F11.2 Impact Bit Holder (Quick Release) Porta-punta de Impacto (Extracción Rápida)

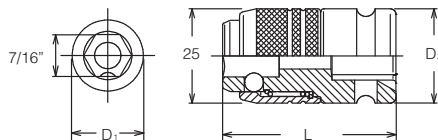

13142-F11.2	D ₁ (mm)	D ₂ (mm)	L (mm)	(g)	(pcs.)	
13142-F11.2	18.9	22	46	116	10	*2

*2 C-Ring=1302C, Pin/O-Ring=1302A/B 

For
DIN3126 / ISO1173 E11.2 Bits

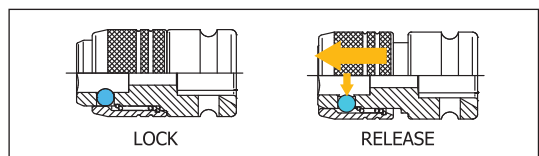
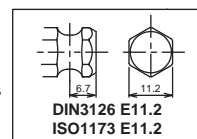

 You may not hold the sliding part while moving to avoid heating up by friction and reduction by wear.

Z-SERIES
HAND
MANUALES
TITANIUM
DE TITANIO
ACCESSORIES
ACCESORIOS
SCREWDRIVERS
DESTORNILLADORES
IMPACT
DE IMPACTO
SLEEVE-DRIVE
INDUSTRIAL
INDUSTRIALES
PROTECTOR
PROTECTORES
AUTOMOTIVE
CONSTRUCTION
CONSTRUCCION
RENEWAL KITS
JUEGOS DE PIEZAS/REPLUSTO

183H-35 · -75 · -150

Hex Bits
Puntas Hexagonales

183H.35 (inch)	L (mm)	(g)	(pcs.)
3/16	35	15	10
7/32	35	16	10
1/4	35	18	10
5/16	35	20	10
3/8	35	26	10
7/16	35	28	10
1/2	35	38	10

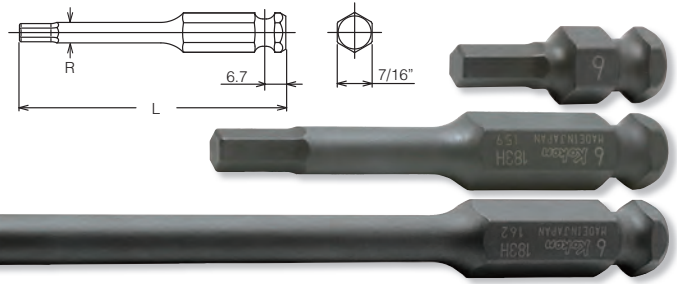

183H.35 (mm)	L (mm)	(g)	(pcs.)
3	35	15	10
4	35	15	10
5	35	15	10
6	35	18	10
7	35	19	10
8	35	20	10
10	35	26	10
11	35	28	10
12	35	30	10
14	35	35	10
16	35	47	10
17	35	50	10
18	35	53	10
19	35	56	10

183H.75 (mm)	L (mm)	R (mm)	(g)	(pcs.)
3	75	6	34	10
4	75	6	35	10
5	75	6.5	36	10
6	75	7.5	39	10
7	75	8.5	44	10
8	75	9.5	47	10
10	75	-	57	10
11	75	-	60	10
12	75	-	65	10
14	75	-	79	10

183H.150 (mm)	L (mm)	R (mm)	(g)	(pcs.)
4	150	6	51	10
5	150	6.5	55	10
6	150	7.5	65	10
8	150	9.5	87	10
10	150	-	118	10
12	150	-	136	10

183T-35 · -75 · -150 (T)

TORX® Bits
Puntas TORX®

183T.35 (T)	L (mm)	(g)	(pcs.)
T25	35	18	10
T30	35	18	10
T40	35	20	10
T45	35	22	10
T50	35	26	10
T55	35	30	10
T60	35	38	10

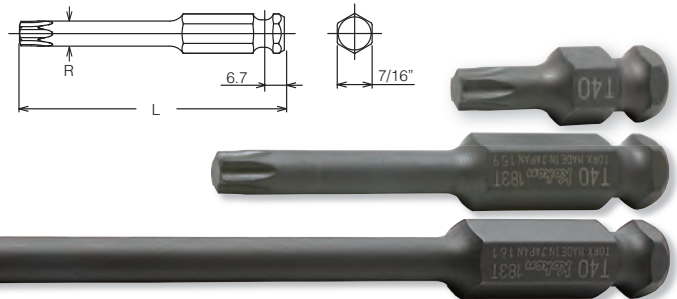

183T.75 (T)	L (mm)	R (mm)	(g)	(pcs.)
T30	75	6	35	10
T40	75	6.9	37	10
T45	75	8	41	10
T50	75	9	45	10
T55	75	11.4	55	10
T60	75	13.5	67	10

183T.150 (T)	L (mm)	R (mm)	(g)	(pcs.)
T30	150	6	50	10
T40	150	6.9	58	10
T45	150	8	70	10
T50	150	9	82	10
T55	150	11.4	113	10

183T.35 (IP)	L (mm)	(g)	(pcs.)
30IP	35	18	10
40IP	35	20	10
45IP	35	22	10
50IP	35	26	10
55IP	35	30	10
60IP	35	38	10

183T-35 · -75 (IP)

TORXPLUS® Bits
Puntas TORXPLUS®

TORXplus®

183T.75 (IP)	L (mm)	R (mm)	(g)	(pcs.)
30IP	75	6	35	10
40IP	75	6.8	37	10
45IP	75	8	41	10
50IP	75	9	45	10
55IP	75	11.4	56	10
60IP	75	13.5	67	10

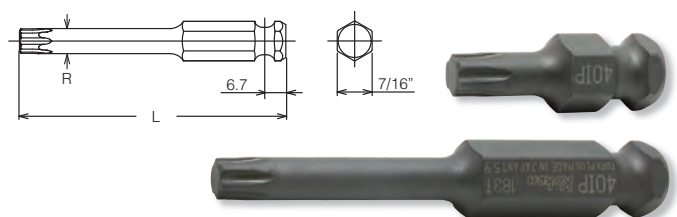

TORX is a registered trademark of Acument Intellectual Properties, LLC.
TORX es una marca registrada de Acument Intellectual Properties, LLC.
TORXplus is a registered trademark of Acument Intellectual Properties, LLC.
TORXplus es una marca registrada de Acument Intellectual Properties, LLC.

Impact Sockets **3/8"**

Z-SERIES
HAND MANUALES
TITANIUM DE TITANIO
ACCESSORIES ACCESORIOS
SCREWDRIVERS DESTORNILLADORES
IMPACT DE IMPACTO
SLEEVE-DRIVE
INDUSTRIAL INDUSTRIALES
PROTECTOR PROTECTORES
AUTOMOTIVE
RENEWAL KITS CONSTRUCTION JUEGOS DE PIEZAS REPUSTO CONSTRUCCIÓN

183X-35 · -75 · -150 (XZN)

XZN Bits
Puntas XZN

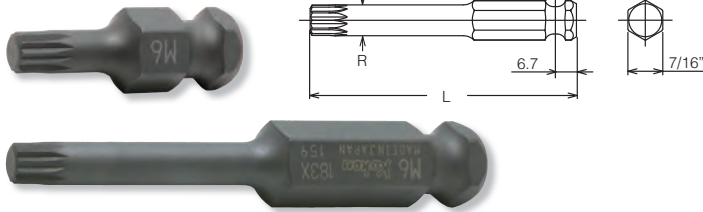

183X.75 (XZN)	L (mm)	R (mm)	(g)	(pcs.)
M 4	75	6	34	10
M 5	75	6	34	10
M 6	75	6.2	36	10
M 8	75	7.4	39	10
M10	75	9.8	54	10
M12	75	11.7	57	10
M14	75	13.5	67	10

183X.35 (XZN)	L (mm)	(g)	(pcs.)
M 4	35	18	10
M 5	35	18	10
M 6	35	20	10
M 8	35	22	10
M10	35	26	10
M12	35	30	10
M14	35	38	10

183X.150 (XZN)	L (mm)	R (mm)	(g)	(pcs.)
M 5	150	6	50	10
M 6	150	6.2	53	10
M 8	150	7.4	64	10
M10	150	9.8	93	10
M12	150	11.7	121	10

13134M-52 · -92

Hex Bit Sockets
Vasos con Punta Hexagonal



13134M-52/-92 (mm)	D (mm)	H (mm)	L (mm)	L (mm)	R (mm)	L=52 (g)	L=92 (g)	(pcs.)	(V)
3	22	20.6	52	92	6	85	104	10	*2
4	22	20.6	52	92	6	85	105	10	*2
5	22	20.6	52	92	6.5	85	106	10	*2
6	22	20.6	52	92	7.5	88	109	10	*2
8	22	20.6	52	92	9.5	90	117	10	*2
10	22	20.6	52	92	-	96	127	10	*2
12	22	20.6	52	92	-	100	135	10	*2
14	22	20.6	52	92	-	105	149	10	*2

*2 C-Ring=1302C, Pin/O-Ring=1302A/B → P254-255

13134T-52 · -92 (T)

TORX® Bit Sockets
Vasos con Punta TORX®

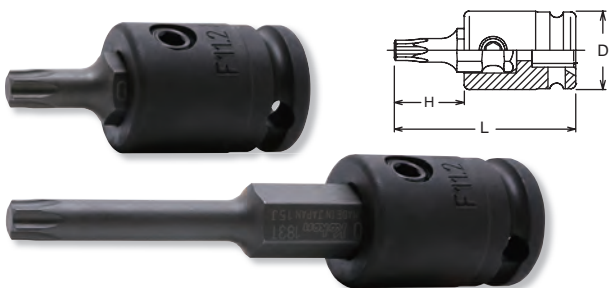

13134T-52/-92 (T)	D (mm)	H (mm)	L (mm)	L (mm)	R (mm)	L=52 (g)	L=92 (g)	(pcs.)	(V)
T30	22	20.6	52	92	6	88	105	10	*2
T40	22	20.6	52	92	6.9	90	107	10	*2
T45	22	20.6	52	92	8	92	111	10	*2
T50	22	20.6	52	92	9	96	115	10	*2
T55	22	20.6	52	92	11.4	100	125	10	*2
T60	22	20.6	52	92	13.5	108	137	10	*2

*2 C-Ring=1302C, Pin/O-Ring=1302A/B → P254-255

13134T-52 · -92 (IP)

TORXPLUS® Bit Sockets
Vasos con Punta TORXPLUS®



13134T-52/-92 (IP)	D (mm)	H (mm)	L (mm)	L (mm)	R (mm)	L=52 (g)	L=92 (g)	(pcs.)	(V)
30IP	22	20.6	52	92	6	88	105	10	*2
40IP	22	20.6	52	92	6.8	90	107	10	*2
45IP	22	20.6	52	92	8	92	111	10	*2
50IP	22	20.6	52	92	9	96	115	10	*2
55IP	22	20.6	52	92	11.4	100	126	10	*2
60IP	22	20.6	52	92	13.5	108	139	10	*2

*2 C-Ring=1302C, Pin/O-Ring=1302A/B → P254-255

13134X-52 · -92 (XZN)

XZN Bit Sockets
Vasos con Punta XZN



13134X-52/-92 (XZN)	D (mm)	H (mm)	L (mm)	L (mm)	R (mm)	L=52 (g)	L=92 (g)	(pcs.)	(V)
M 5	22	20.6	52	92	6	88	104	10	*2
M 6	22	20.6	52	92	6.2	90	106	10	*2
M 8	22	20.6	52	92	7.4	92	109	10	*2
M10	22	20.6	52	92	9.8	96	124	10	*2
M12	22	20.6	52	92	11.7	100	129	10	*2
M14	22	20.6	52	92	13.5	108	139	10	*2

*2 C-Ring=1302C, Pin/O-Ring=1302A/B → P254-255

TORX is a registered trademark of Acument Intellectual Properties, LLC.
TORX es una marca registrada de Acument Intellectual Properties, LLC.
TORXplus is a registered trademark of Acument Intellectual Properties, LLC.
TORXplus es una marca registrada de Acument Intellectual Properties, LLC.

13145M.100 (mm)	D ₁ (mm)	D ₂ (mm)	H (mm)	L (mm)	(g)	(pce.)	
8	13.3	19	8	100	90	1	*1
10	15.8	19	10	100	92	1	*1
12	18.3	19	12	100	100	1	*1
13	19.5	19	13	100	108	1	*1
14	20.8	19	14	100	112	1	*1
17	24.5	19	17	100	140	1	*1

13145M.150 (mm)	D ₁ (mm)	D ₂ (mm)	H (mm)	L (mm)	(g)	(pce.)	
6	10.8	19	6	150	105	1	*1
8	13.3	19	8	150	110	1	*1
10	15.8	19	10	150	120	1	*1
12	18.3	19	12	150	128	1	*1
13	19.5	19	13	150	137	1	*1
14	20.8	19	14	150	146	1	*1
15	22	19	15	150	155	1	*1
17	24.5	19	17	150	163	1	*1

13145M.200 (mm)	D ₁ (mm)	D ₂ (mm)	H (mm)	L (mm)	(g)	(pce.)	
6	10.8	19	6	200	136	1	*1
8	13.3	19	8	200	141	1	*1
10	15.8	19	10	200	151	1	*1
12	18.3	19	12	200	159	1	*1
13	19.5	19	13	200	168	1	*1
14	20.8	19	14	200	177	1	*1
15	22	19	15	200	186	1	*1
17	24.5	19	17	200	194	1	*1

*1 C-Ring=1301C, Pin/O-Ring=1301A/B → P254-255

13145M-100 · -150 · -200 · -250

Extra Long Sockets
Vasos Extra-Largos

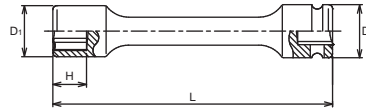

13145M.250 (mm)	D ₁ (mm)	D ₂ (mm)	H (mm)	L (mm)	(g)	(pce.)	
6	10.8	19	6	250	167	1	*1
8	13.3	19	8	250	172	1	*1
10	15.8	19	10	250	182	1	*1
12	18.3	19	12	250	190	1	*1
13	19.5	19	13	250	199	1	*1
14	20.8	19	14	250	208	1	*1
15	22	19	15	250	217	1	*1
17	24.5	19	17	250	225	1	*1

*1 C-Ring=1301C, Pin/O-Ring=1301A/B → P254-255

13145MG.100 (mm)	D ₁ (mm)	D ₂ (mm)	H (mm)	L (mm)	(g)	(pce.)	
8	13.3	19	3.5	100	90	1	*1
10	15.8	19	4.2	100	93	1	*1
12	18.3	19	5.6	100	105	1	*1
13	19.5	19	6	100	115	1	*1
14	20.8	19	6.4	100	120	1	*1

13145MG.150 (mm)	D ₁ (mm)	D ₂ (mm)	H (mm)	L (mm)	(g)	(pce.)	
8	13.3	19	3.5	150	120	1	*1
10	15.8	19	4.2	150	125	1	*1
12	18.3	19	5.6	150	136	1	*1
13	19.5	19	6	150	145	1	*1
14	20.8	19	6.4	150	150	1	*1

13145MG.200 (mm)	D ₁ (mm)	D ₂ (mm)	H (mm)	L (mm)	(g)	(pce.)	
10	15.8	19	4.2	200	182	1	*1
12	18.3	19	5.6	200	190	1	*1
13	19.5	19	6	200	208	1	*1
14	20.8	19	6.4	200	225	1	*1

*1 C-Ring=1301C, Pin/O-Ring=1301A/B → P254-255

13145MG-100 · -150 · -200

Extra Long Sockets with Magnet
Vasos Extra-Largos con Imán

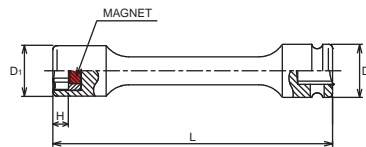

13145M.100 (12P) (mm)	D ₁ (mm)	D ₂ (mm)	H (mm)	L (mm)	(g)	(pce.)	
10	15.8	19	10	100	91	1	*1
12	18.3	19	12	100	100	1	*1

13145M.150 (12P) (mm)	D ₁ (mm)	D ₂ (mm)	H (mm)	L (mm)	(g)	(pce.)	
10	15.8	19	10	150	120	1	*1
12	18.3	19	12	150	128	1	*1

13145M.200 (12P) (mm)	D ₁ (mm)	D ₂ (mm)	H (mm)	L (mm)	(g)	(pce.)	
10	15.8	19	10	200	151	1	*1
12	18.3	19	12	200	159	1	*1

*1 C-Ring=1301C, Pin/O-Ring=1301A/B → P254-255

13145M-100 (12P) · -150 (12P) · -200 (12P)

Extra Long 12-point Sockets
Vasos Bihexagonales, Extra-Largos

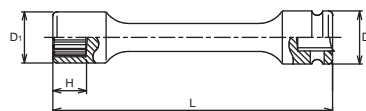

Z-SERIES
HAND
MANUALES
TITANIUM
DE TITANIO
ACCESSORIES
ACCESORIOS
DESTORNILLADORES
SCREWDRIVERS
DE IMPACTO
IMPACT
SLEEVE-DRIVE
INDUSTRIAL
INDUSTRIALES
PROTECTOR
PROTECTORES
AUTOMOTIVE
CONSTRUCTION
CONSTRUCCION
RENEWAL KITS
JUEGOS DE HERRAMIENTAS

Z-SERIES
HAND MANUALES
TITANIUM DE TITANIO
ACCESSORIES ACCESORIOS
SCREWDRIVERS DESTORNILLADORES
IMPACT DE IMPACTO
SLEEVE-DRIVE
INDUSTRIAL INDUSTRIALES
PROTECTOR PROTECTORES
AUTOMOTIVE
CONSTRUCTION CONSTRUCCIÓN
RENEWAL KITS JUEGOS DE PIEZAS REPUESTO

13146M-150 · -200 · -250

Extra Long Universal Sockets
Vasos Extra Largo con Articulación Universal



13146M.150 (mm)	D ₁ (mm)	D ₂ (mm)	H (mm)	L (mm)	(g)	(pce.)	
8	12	19	6	150	128	1	*1
10	14.3	19	7	150	131	1	*1
12	18	19	8	150	133	1	*1
13	19.3	19	8.5	150	132	1	*1
14	20	19	9	150	132	1	*1

13146M.200 (mm)	D ₁ (mm)	D ₂ (mm)	H (mm)	L (mm)	(g)	(pce.)	
8	12	19	6	200	159	1	*1
10	14.3	19	7	200	162	1	*1
12	18	19	8	200	164	1	*1
13	19.3	19	8.5	200	163	1	*1
14	20	19	9	200	163	1	*1

13146M.250 (mm)	D ₁ (mm)	D ₂ (mm)	H (mm)	L (mm)	(g)	(pce.)	
8	12	19	6	250	190	1	*1
10	14.3	19	7	250	193	1	*1
12	18	19	8	250	195	1	*1
13	19.3	19	8.5	250	194	1	*1
14	20	19	9	250	194	1	*1

*1 C-Ring=1301C, Pin/O-Ring=1301A/B → P254-255

13147M-150 · -200

Extra Long Universal Inhex Sockets
Vasos Inhex Extra Largos con Articulación Universal

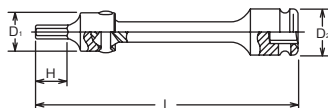

13147M.150 (mm)	D ₁ (mm)	D ₂ (mm)	H (mm)	L (mm)	(g)	(pce.)	
4	21	19	15	150	125	1	*1
5	21	19	15	150	128	1	*1
6	21	19	15	150	132	1	*1
8	21	19	15	150	136	1	*1
10	21	19	15	150	140	1	*1

13147M.200 (mm)	D ₁ (mm)	D ₂ (mm)	H (mm)	L (mm)	(g)	(pce.)	
4	21	19	15	200	156	1	*1
5	21	19	15	200	159	1	*1
6	21	19	15	200	163	1	*1
8	21	19	15	200	167	1	*1
10	21	19	15	200	171	1	*1

*1 C-Ring=1301C, Pin/O-Ring=1301A/B → P254-255

13760 Extension Bars Alargaderas

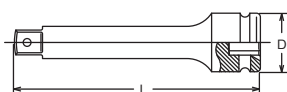

13760	D (mm)	L (mm)	(g)	(pcs.)	
50	22	50	70	10	*2
75	22	75	95	10	*2
100	22	100	120	10	*2
125	22	125	141	5	*2
150	22	150	165	5	*2
200	22	200	210	5	*2
250	22	250	260	5	*2

*2 C-Ring=1302C, Pin/O-Ring=1302A/B → P254-255

	L (mm)	(g)	(pcs.)	
13333AL	45	62	10	*1

*1 C-Ring=1301C, Pin/O-Ring=1301A/B → P254-255

Lock & Quick Release

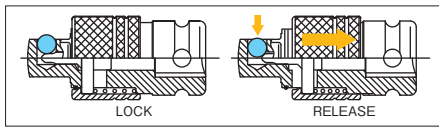

⚠ You may not hold the sliding part while moving to avoid heating up by friction and reduction by wear.

	L (mm)	(g)	(pcs.)	
13770	56	110	10	*2
13770-B	56	110	10	*2
13770-P	56	110	10	*2
13771	48	92	10	*2
13771-B	48	92	10	*2
13771-P	48	92	10	*2

*2 C-Ring=1302C, Pin/O-Ring=1302A/B → P254-255

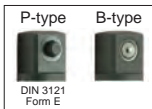
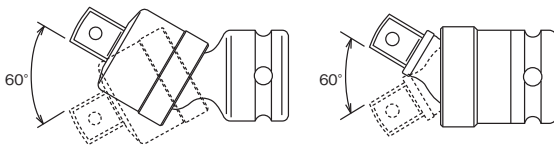

	D ₁ (mm)	D ₂ (mm)	L (mm)	(g)	(pcs.)	
13772-B	22	19	75	120	5	*1
13772-P	22	19	75	120	5	*1

*1 C-Ring=1301C, Pin/O-Ring=1301A/B → P254-255

⚠ 13772 and 14772 have less load capacity than standard. In the interest of your safety always use properly.

	(sq.)	(sq.)	L (mm)	(g)	(pcs.)	
13322A	3/8"	1/4"	27	25	10	*1
13322A-B	3/8"	1/4"	27	25	10	*1
13322A-P	3/8"	1/4"	27	25	10	*1

*1 C-Ring=1301C, Pin/O-Ring=1301A/B → P254-255

⚠ Adapting down from bigger square drive to smaller square drive may lead to excessive torque load and possibly cause breakage. Always stay within safe torque of the smaller square drive.

	(sq.)	(sq.)	L (mm)	(g)	(pcs.)	
13344A	3/8"	1/2"	32.5	53	10	*2
13344A-B	3/8"	1/2"	32.5	53	10	*2
13344A-P	3/8"	1/2"	32.5	53	10	*2

*2 C-Ring=1302C, Pin/O-Ring=1302A/B → P254-255

13241M 11 Pieces Set/△=850g

METAL CASE:W240xH30xT35mm

Sockets

13400M 6-pt. Sockets
9, 10, 11, 12, 13, 14, 15, 16, 17, 18, 19

13242M 11 Pieces Set/△=1,140g

METAL CASE:W310xH90xT48mm

Sockets

13400M 6-pt. Sockets
9, 10, 11, 12, 13, 14, 15, 16, 17, 18, 19



LOCKING ADAPTOR

13333AL Adaptor (Quick Release)
Adaptador (Extracción Rápida) **⚠**

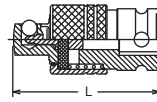

13770 Universal Joint
Articulación Universal

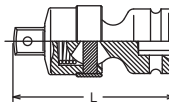

13771 Universal Joint
Articulación Universal

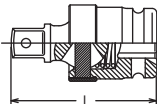

13772 Universal Double Joint
Articulación Universal **⚠**



UNIVERSAL DOUBLE JOINT



13322A Adaptor
Adaptador **⚠**

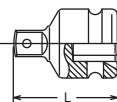

13344A Adaptor
Adaptador

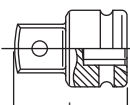

13241M Socket Set
Juego de Vasos



13242M Socket Set
Juego de Vasos



Z-SERIES
HAND
MANUALES
TITANIUM
DE TITANIO
ACCESSORIES
ACCESORIOS
SCREWDRIVERS
DESTORNILLADORES
IMPACT
DE IMPACTO
SLEEVE-DRIVE
INDUSTRIAL
INDUSTRIALES
PROTECTOR
PROTECTORES
AUTOMOTIVE
CONSTRUCTION
CONSTRUCCION
RENEWAL KITS
JUEGOS DE PIEZAS/REPOSTO

Impact Sockets 1/2"

Z-SERIES
 HAND MANUALES
 TITANIUM DE TITANIO
 ACCESSORIES ACCESORIOS
 SCREWDRIVERS DESTORNILLADORES
 IMPACTO DE IMPACTO
 SLEEVE-DRIVE
 INDUSTRIAL INDUSTRIALES
 PROTECTOR PROTECTORES
 AUTOMOTIVE
 CONSTRUCTION CONSTRUCCIÓN
 RENEWAL KITS JUEGOS DE PIEZAS REPUESTO

14400M • 14400A ⊙ 6-point Sockets Vasos Hexagonales

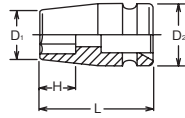

14400A (inch)	D ₁ (mm)	D ₂ (mm)	H (mm)	L (mm)	(g)	(pcs.)	⊙
1/4	12	25	5	38	80	10	*1
5/16	14.5	25	6	38	85	10	*1
3/8	17	25	7	38	85	10	*1
7/16	18.2	25	8	38	85	10	*1
1/2	20.7	25	10	38	85	10	*1
9/16	22	25	10	38	85	10	*1
19/32	23.2	30	11	38	130	10	*2
5/8	24.5	30	11	38	130	10	*2
11/16	25.7	30	12	38	130	10	*2
3/4	28.2	30	13	38	125	10	*2
13/16	30.7	30	14	38	120	10	*2
7/8	32	30	14	38	130	10	*2
15/16	34.5	30	14	38	135	10	*2
1	35.7	30	14	38	135	10	*2
1. 1/16	38.2	30	16	40	160	10	*2
1. 1/8	40.7	30	17	42	190	10	*2
1. 3/16	42	30	17	42	190	10	*2
1. 1/4	44.5	30	18	42	216	10	*2
1. 5/16	45.7	30	19	46	260	5	*2
1. 3/8	47	30	19	46	263	5	*2
1. 1/2	52	30	20	53	365	5	*2

*1 C-Ring=1401C, Pin/O-Ring=1401A/B → P254-255
 *2 C-Ring=1402C, Pin/O-Ring=1402A/B

14400M (mm)	D ₁ (mm)	D ₂ (mm)	H (mm)	L (mm)	(g)	(pcs.)	⊙
8	14.5	25	6	38	85	10	*1
9	15.7	25	7	38	85	10	*1
10	17	25	7	38	85	10	*1
11	18.2	25	8	38	85	10	*1
12	19.5	25	9	38	85	10	*1
13	20.7	25	10	38	85	10	*1
14	22	25	10	38	85	10	*1
15	23.2	30	11	38	130	10	*2
16	24.5	30	11	38	130	10	*2
17	25.7	30	12	38	130	10	*2
18	27	30	13	38	130	10	*2
19	28.2	30	13	38	125	10	*2
20	29.5	30	13	38	127	10	*2
21	30.7	30	14	38	120	10	*2
22	32	30	14	38	130	10	*2
23	33.2	30	14	38	130	10	*2
24	34.5	30	14	38	135	10	*2
25	35.7	30	14	38	135	10	*2
26	37	30	14	38	160	10	*2
27	38.2	30	16	40	160	10	*2
28	39.5	30	16	40	170	10	*2
29	40.7	30	17	42	190	10	*2
30	42	30	17	42	190	10	*2
31	43.2	30	17	42	213	10	*2
32	44.5	30	18	42	216	10	*2
33	45.7	30	19	46	260	5	*2
34	47	30	19	46	263	5	*2
35	48.2	30	19	46	275	5	*2
36	49.5	30	20	46	285	5	*2
38	52	30	20	53	360	5	*2
41	55.7	30	21	55	411	2	*2

*1 C-Ring=1401C, Pin/O-Ring=1401A/B → P254-255
 *2 C-Ring=1402C, Pin/O-Ring=1402A/B

14405M • 14405A ⊙ 12-point Sockets Vasos Bihexagonales

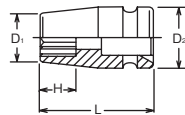

14405A (inch)	D ₁ (mm)	D ₂ (mm)	H (mm)	L (mm)	(g)	(pcs.)	⊙
5/16	14.5	25	6	38	85	10	*1
3/8	17	25	7	38	85	10	*1
7/16	18.2	25	8	38	85	10	*1
1/2	20.7	25	10	38	85	10	*1
9/16	22	25	10	38	85	10	*1
5/8	24.5	30	11	38	130	10	*2
11/16	25.7	30	12	38	130	10	*2
3/4	28.2	30	13	38	125	10	*2
13/16	30.7	30	14	38	120	10	*2
7/8	32	30	14	38	130	10	*2
15/16	34.5	30	14	38	135	10	*2
1	35.7	30	14	38	135	10	*2
1. 1/16	38.2	30	16	40	160	10	*2
1. 1/8	40.7	30	17	42	190	10	*2
1. 3/16	42	30	17	42	190	10	*2
1. 1/4	44.5	30	18	42	216	10	*2
1. 5/16	45.7	30	19	46	260	5	*2
1. 3/8	47	30	19	46	263	5	*2
1. 1/2	52	30	20	53	365	5	*2

*1 C-Ring=1401C, Pin/O-Ring=1401A/B → P254-255
 *2 C-Ring=1402C, Pin/O-Ring=1402A/B

14405M (mm)	D ₁ (mm)	D ₂ (mm)	H (mm)	L (mm)	(g)	(pcs.)	⊙
8	14.5	25	6	38	85	10	*1
9	15.7	25	7	38	85	10	*1
10	17	25	7	38	85	10	*1
11	18.2	25	8	38	84	10	*1
12	19.5	25	9	38	84	10	*1
13	20.7	25	10	38	84	10	*1
14	22	25	10	38	84	10	*1
15	23.2	30	11	38	130	10	*2
16	24.5	30	11	38	127	10	*2
17	25.7	30	12	38	128	10	*2
18	27	30	13	38	130	10	*2
19	28.2	30	13	38	125	10	*2
20	29.5	30	13	38	127	10	*2
21	30.7	30	14	38	120	10	*2
22	32	30	14	38	130	10	*2
23	33.2	30	14	38	132	10	*2
24	34.5	30	14	38	133	10	*2
26	37	30	14	38	147	10	*2
27	38.2	30	16	40	157	10	*2
28	39.5	30	16	40	170	10	*2
30	42	30	17	42	190	10	*2
32	44.5	30	18	42	216	10	*2
36	49.5	30	20	46	285	5	*2
41	55.7	30	21	55	411	2	*2

*1 C-Ring=1401C, Pin/O-Ring=1401A/B → P254-255
 *2 C-Ring=1402C, Pin/O-Ring=1402A/B

1/2" Impact Sockets

14401M (mm)	D ₁ (mm)	D ₂ (mm)	H (mm)	L (mm)	(g)	(pcs.)	
8	13	24	6	38	57	10	*1
9	14.2	24	7	38	58	10	*1
10	15.5	24	7	38	60	10	*1
11	16.7	24	8	38	62	10	*1
12	18	24	9	38	63	10	*1
13	19.2	24	10	38	65	10	*1
14	20.5	24	10	38	67	10	*1
15	21.7	29	11	38	100	10	*2
16	23	29	11	38	102	10	*2
17	24.2	29	12	38	105	10	*2
18	25.5	29	13	38	105	10	*2
19	26.7	29	13	38	107	10	*2
20	28	29	13	38	108	10	*2
21	29.2	29	14	38	109	10	*2
22	30.5	29	14	38	114	10	*2
23	31.7	29	14	38	118	10	*2
24	33	29	14	38	122	10	*2
25	34.2	29	14	38	129	10	*2
26	35.5	29	14	38	131	10	*2
27	36.7	29	16	40	145	10	*2
28	38	29	16	40	152	10	*2
29	39.2	29	17	42	165	10	*2
30	40.5	29	17	42	178	10	*2
31	41.7	29	17	42	185	10	*2
32	43	29	18	42	188	10	*2
33	44.2	29	19	46	219	5	*2
34	45.5	29	19	46	248	5	*2
35	46.7	29	19	46	250	5	*2
36	48	29	20	46	264	5	*2
38	50.5	29	20	53	316	5	*2
41	54.2	29	21	55	374	2	*2

*1 C-Ring=1401C, Pin/O-Ring=1401A/B
*2 C-Ring=1402C, Pin/O-Ring=1402A/B



14401M • 14401A

6-point Sockets, Thin Walled
Vasos Hexagonales de Pared Delgada

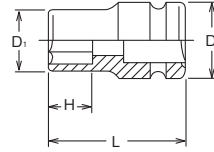

14401A (inch)	D ₁ (mm)	D ₂ (mm)	H (mm)	L (mm)	(g)	(pcs.)	
1/4	10.5	24	5	38	55	10	*1
5/16	13	24	6	38	57	10	*1
3/8	15.5	24	7	38	60	10	*1
7/16	16.7	24	8	38	62	10	*1
1/2	19.2	24	10	38	65	10	*1
9/16	20.5	24	10	38	67	10	*1
5/8	23	29	11	38	102	10	*2
11/16	24.2	29	12	38	105	10	*2
3/4	26.7	29	13	38	107	10	*2
13/16	29.2	29	14	38	109	10	*2
7/8	30.5	29	14	38	114	10	*2
15/16	33	29	14	38	122	10	*2
1	34.2	29	14	38	129	10	*2
1. 1/16	35.5	29	14	40	131	10	*2
1. 1/8	39.2	29	17	42	165	10	*2
1. 3/16	40.5	29	17	42	178	10	*2
1. 1/4	43	29	18	42	188	10	*2
1. 5/16	44.2	29	19	46	219	5	*2
1. 3/8	45.5	29	19	46	248	5	*2

*1 C-Ring=1401C, Pin/O-Ring=1401A/B
*2 C-Ring=1402C, Pin/O-Ring=1402A/B

RS14401M/10	10 Pieces Set/Rail 300mm	(g)
10, 12, 13, 14, 17, 19, 21, 22, 24, 27		1,010



RS14401M/10

Socket Set on Rail
Juego de Vasos en Regleta



14406M • 14406A

12-point Sockets, Thin Walled
Vasos Bihexagonales de Pared Delgada

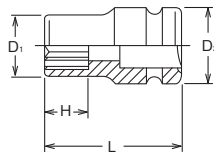

14406M (mm)	D ₁ (mm)	D ₂ (mm)	H (mm)	L (mm)	(g)	(pcs.)	
8	13	24	6	38	57	10	*1
9	14.2	24	7	38	58	10	*1
10	15.5	24	7	38	60	10	*1
11	16.7	24	8	38	62	10	*1
12	18	24	9	38	63	10	*1
13	19.2	24	10	38	65	10	*1
14	20.5	24	10	38	67	10	*1
15	21.7	29	11	38	100	10	*2
16	23	29	11	38	102	10	*2
17	24.2	29	12	38	105	10	*2
18	25.5	29	13	38	105	10	*2
19	26.7	29	13	38	107	10	*2
20	28	29	13	38	108	10	*2
21	29.2	29	14	38	109	10	*2
22	30.5	29	14	38	114	10	*2
23	31.7	29	14	38	118	10	*2
24	33	29	14	38	122	10	*2
25	34.2	29	14	38	129	10	*2
26	35.5	29	14	38	131	10	*2
27	36.7	29	16	40	145	10	*2
28	38	29	16	40	152	10	*2
29	39.2	29	17	42	165	10	*2
30	40.5	29	17	42	178	10	*2
31	41.7	29	17	42	185	10	*2
32	43	29	18	42	188	10	*2
33	44.2	29	19	46	219	5	*2
34	45.5	29	19	46	248	5	*2
36	48	29	20	46	264	5	*2

*1 C-Ring=1401C, Pin/O-Ring=1401A/B
*2 C-Ring=1402C, Pin/O-Ring=1402A/B

14406A (inch)	D ₁ (mm)	D ₂ (mm)	H (mm)	L (mm)	(g)	(pcs.)	
1/4	10.5	24	5	38	55	10	*1
5/16	13	24	6	38	57	10	*1
3/8	15.5	24	7	38	60	10	*1
7/16	16.7	24	8	38	62	10	*1
1/2	19.2	24	10	38	65	10	*1
9/16	20.5	24	10	38	67	10	*1
5/8	23	29	11	38	102	10	*2
11/16	24.2	29	12	38	105	10	*2
3/4	26.7	29	13	38	107	10	*2
13/16	29.2	29	14	38	109	10	*2
7/8	30.5	29	14	38	114	10	*2
15/16	33	29	14	38	122	10	*2
1	34.2	29	14	38	129	10	*2
1. 1/16	35.5	29	14	40	131	10	*2
1. 1/8	39.2	29	17	42	165	10	*2
1. 3/16	40.5	29	17	42	178	10	*2
1. 1/4	43	29	18	42	188	10	*2
1. 5/16	44.2	29	19	46	219	5	*2
1. 3/8	45.5	29	19	46	248	5	*2

*1 C-Ring=1401C, Pin/O-Ring=1401A/B
*2 C-Ring=1402C, Pin/O-Ring=1402A/B

Z-SERIES
HAND
MANUALES
TITANIUM
DE TITANIO
ACCESSORIES
ACCESORIOS
SCREWDRIVERS
DESTORNILLADORES
IMPACT
DE IMPACTO
SLEEVE-DRIVE
INDUSTRIAL
INDUSTRIALES
PROTECTOR
PROTECTORES
AUTOMOTIVE
CONSTRUCTION
CONSTRUCCION
RENEWAL KITS
JUEGOS DE PIEZAS/REPUESTO

Impact Sockets 1/2"

Z-SERIES
HAND MANUALES
TITANIUM DE TITANIO
ACCESSORIES ACCESORIOS
SCREWDRIVERS DESTORNILLADORES
IMPACT DE IMPACTO
SLEEVE-DRIVE
INDUSTRIAL INDUSTRIALES
PROTECTOR PROTECTORES
AUTOMOTIVE
CONSTRUCTION CONSTRUCCIÓN
RENEWAL KITS JUEGOS DE PIEZAS REPUESTO

14401MS

6-point Short Sockets, Thin-walled.
Vasos Hexagonales de Pared Delgada, Short

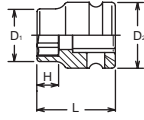

14401MS (mm)	D ₁ (mm)	D ₂ (mm)	H (mm)	L (mm)	(g)	(pcs.)	
New 10	15.5	24	4.5	23	41	10	*1
New 12	18	24	5.5	24	42	10	*1
New 13	19.2	24	6.5	25	43	10	*1
14	20.5	24	6.5	25	43	10	*1
17	24.2	29	7.5	26	76	10	*2
19	26.7	29	9.5	28	79	10	*2
New 21	29.2	29	10	28.5	79	10	*2
22	30.5	29	10	28.5	84	10	*2
24	33	29	10	28.5	87	10	*2
New 27	36.7	29	10	28.5	100	10	*2

*1 C-Ring=1401C, Pin/O-Ring=1401A/B
*2 C-Ring=1402C, Pin/O-Ring=1402A/B

RS14401MS/10

Socket Set on Rail
Juego de Vasos en Regleta



RS14401MS/10	10 Pieces Set/Rail 300mm	(g)
New	10, 12, 13, 14, 17, 19, 21, 22, 24, 27	740

14400MG

6-point Sockets with Magnet
Vasos Hexagonales con Imán

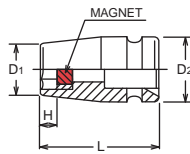

14400MG (mm)	D ₁ (mm)	D ₂ (mm)	H (mm)	L (mm)	(g)	(pcs.)	
8	14.5	25	3.5	38	95	10	*1
10	17	25	4.2	38	95	10	*1
12	19.5	25	5.6	38	100	10	*1
13	20.7	25	6	38	100	10	*1
14	22	25	6.4	38	105	10	*1
15	23.2	30	6.8	38	140	10	*2
16	24.5	30	7	38	145	10	*2
17	25.7	30	7.5	38	145	10	*2
18	27	30	7.8	38	147	10	*2
19	28.2	30	8	38	147	10	*2
21	30.7	30	8	38	165	10	*2

*1 C-Ring=1401C, Pin/O-Ring=1401A/B
*2 C-Ring=1402C, Pin/O-Ring=1402A/B

14410M

Surface Drive Sockets
Vasos Surface Drive (de Contacto Curvo)

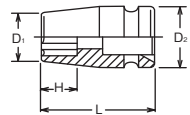

14410M (mm)	D ₁ (mm)	D ₂ (mm)	H (mm)	L (mm)	(g)	(pcs.)	
10	17	25	7	38	100	10	*1
11	18.2	25	8	38	103	10	*1
12	19.5	25	9	38	110	10	*1
13	20.7	25	10	38	113	10	*1
14	22	25	10	38	115	10	*1
15	23.2	30	11	38	120	10	*2
16	24.5	30	11	38	120	10	*2
17	25.7	30	12	38	126	10	*2
18	27	30	13	38	121	10	*2
19	28.2	30	13	38	124	10	*2
20	29.5	30	13	38	123	10	*2
21	30.7	30	14	38	120	10	*2
22	32	30	14	38	130	10	*2
24	34.5	30	14	38	134	10	*2
25	35.7	30	14	38	135	10	*2
26	37	30	14	38	160	10	*2
27	38.2	30	16	40	160	10	*2
28	39.5	30	16	40	170	10	*2
29	40.7	30	17	42	190	10	*2
30	42	30	17	42	190	10	*2
31	43.2	30	17	42	213	10	*2
32	44.5	30	18	42	216	10	*2
34	47	30	19	46	263	5	*2
36	49.5	30	20	46	263	5	*2

*1 C-Ring=1401C, Pin/O-Ring=1401A/B
*2 C-Ring=1402C, Pin/O-Ring=1402A/B

SURFACE DRIVE

Surface drive sockets are designed to retain contact with flat sides of nut to transmit high torque and reduce nut wear. These sockets are ideal for use on polished nuts, aluminum nuts and nuts with worn out points.

Los vasos de contacto se diseñan para mantener el contacto con las caras planas de la tuerca y transmitir un alto par reduciendo el desgaste de la tuerca. Estos vasos son ideales para utilizarse en tuercas pulidas, tuercas de aluminio y tuercas con puntas gastadas

14465M (mm)	D ₁ (mm)	D ₂ (mm)	H (mm)	L (mm)	(g)	(pcs.)	
10	17	25	8	38	89	10	*1
11	18.2	25	8	38	87	10	*1
12	19.5	25	9	38	87	10	*1
13	20.7	25	9	38	86	10	*1
14	22	25	11	38	86	10	*1
15	23.2	30	11	38	131	10	*2
16	24.5	30	11	38	131	10	*2
17	25.7	30	12	38	132	10	*2
18	27	30	13	38	128	10	*2
19	28.2	30	13	38	128	10	*2
20	29.5	30	14	38	125	10	*2
21	30.7	30	14	38	128	10	*2
22	32	30	15	38	130	10	*2
23	33.2	30	15	38	135	10	*2
24	34.5	30	15	38	135	10	*2
26	37	30	15	38	152	10	*2
27	38.2	30	16	40	169	10	*2

*1 C-Ring=1401C, Pin/O-Ring=1401A/B
 *2 C-Ring=1402C, Pin/O-Ring=1402A/B
 → P254-255



14465M Pathfinder Sockets Vasos Pathfinder (Guía)

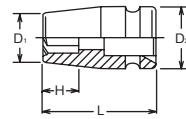

PATHFINDER®

The beveled flats of the 6-point opening of the PATHFINDER socket engage the nut almost immediately. PATHFINDER sockets are ideal for use with power tools in automatic assembly processes, as the power tool does not have to be totally stopped for the socket to engage the nut.

Las caras biseladas de la boca hexagonal del vaso GUÍA acoplan el vaso inmediatamente. Los vasos GUÍA son ideales para su utilización con herramientas mecánicas en procesos de montaje automáticos, ya que no es necesario que la herramienta esté completamente parada para acoplar el vaso a la tuerca.

14415M (mm)	D ₁ (mm)	D ₂ (mm)	H (mm)	L (mm)	(g)	(pcs.)	
14	25.7	30	10	38	138	10	*1
15	27	30	11	38	145	10	*1
16	29.5	30	11	38	150	10	*1
17	30.7	30	12	38	155	10	*1
18	32	30	13	38	165	10	*1
19	33.2	30	14	38	170	10	*1
22	38.2	30	14	40	185	10	*1
24	42	30	14	42	215	10	*1
27	45.7	30	16	46	278	5	*1
28	47	30	16	46	285	5	*1
29	49.5	30	17	46	326	5	*2

*1 C-Ring=1402C, Pin/O-Ring=1402A/B
 → P254-255

14415M Double Square Sockets Vasos Octagonales

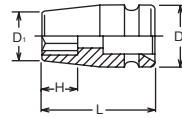

14425 (E)	D ₁ (mm)	D ₂ (mm)	H (mm)	L (mm)	(g)	(pcs.)	
E10	14.2	25	8.2	38	86	10	*1
E11	14.7	25	8.7	38	86	10	*1
E12	15.2	25	9.3	38	85	10	*1
E14	18.2	25	10.6	38	88	10	*1
E16	19.2	25	11.8	38	88	10	*1
E18	22.2	25	13	38	89	10	*1
E20	24.2	30	14.4	38	134	10	*2
E22	26.2	30	15.5	40	140	10	*2
E24	28.2	30	17	40	138	10	*2

*1 C-Ring=1401C, Pin/O-Ring=1401A/B
 *2 C-Ring=1402C, Pin/O-Ring=1402A/B
 → P254-255

14425 TORX® Sockets Vasos TORX®

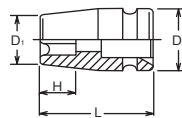

14425-EPL TORXPLUS® Sockets Vasos TORXPLUS®

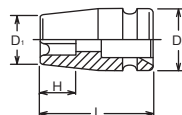

14425-EPL (EPL)	D ₁ (mm)	D ₂ (mm)	H (mm)	L (mm)	(g)	(pcs.)	
10EPL	14.5	25	6.2	38	86	10	*1
12EPL	17	25	7.2	38	86	10	*1
14EPL	18.2	25	8.1	38	88	10	*1
16EPL	20.7	25	9.1	38	88	10	*1
18EPL	22	25	10.2	40	90	10	*1
20EPL	24.5	30	11.2	42	135	10	*2

*1 C-Ring=1401C, Pin/O-Ring=1401A/B
 *2 C-Ring=1402C, Pin/O-Ring=1402A/B
 → P254-255

Impact Sockets 1/2"

Z-SERIES
HAND MANUALES
TITANIUM DE TITANIO
ACCESSORIES ACCESORIOS
SCREWDRIVERS DESTORNILLADORES
IMPACT DE IMPACTO
SLEEVE-DRIVE
INDUSTRIAL INDUSTRIALES
PROTECTOR PROTECTORES
AUTOMOTIVE
RENEWAL KITS CONSTRUCCION JUEGOS DE PIEZAS REPUESTO CONSTRUCCION

14400-WN Weld Nut Sockets

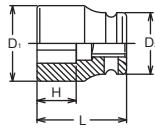

14400-WN	D ₁ (mm)	D ₂ (mm)	H (mm)	L (mm)	(g)	(pcs.)	
8WN	18.3	25	8	38	93	10	*1
9WN	19.5	25	9	38	93	10	*1
10WN	20.8	25	10	38	92	10	*1
12WN	24.5	30	12	38	139	10	*2
14WN	27	30	14	38	136	10	*2
17WN	32	30	17	40	150	10	*2

*1 C-Ring=1401C, Pin/O-Ring=1401A/B
*2 C-Ring=1402C, Pin/O-Ring=1402A/B → P254-255

WN

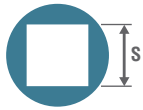

WN	6WN	8WN	9WN	10WN	12WN	14WN	17WN
S (ref. mm)	6	8	9	10	12	14	17

14401LH LHS Sockets Vasos LHS

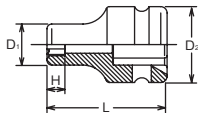

14401LH (LH-S)	D ₁ (mm)	D ₂ (mm)	H (mm)	L (mm)	(g)	(pcs.)	
6S	13	25	5.6	38	65	10	*1
8S	16.7	25	6.8	38	69	10	*1
10S	19.2	25	8	38	75	10	*1
12S	23	30	9.2	38	115	10	*2
14S	25.5	30	10.4	38	121	10	*2
16S	29.2	30	11.6	38	128	10	*2

*1 C-Ring=1401C, Pin/O-Ring=1401A/B
*2 C-Ring=1402C, Pin/O-Ring=1402A/B → P254-255

LHSTIX®

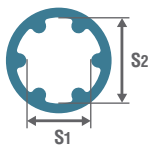

LH-S	LH-5S	LH-6S	LH-8S	LH-10S	LH-12S	LH-14S	LH-16S
S ₁ (ref. mm)	5.6	6.8	9.0	11.3	13.6	15.8	18.1
S ₂ (ref. mm)	7.5	9.0	12.0	15.0	18.0	21.0	24.0

14301X 6-point Sockets, Semi-Deep Vasos Hexagonales Madianos de pared Delgada

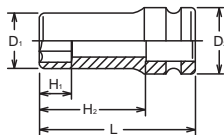

14301X (mm)	D ₁ (mm)	D ₂ (mm)	H ₁ (mm)	H ₂ (mm)	L (mm)	(g)	(pcs.)	
8	13	24	8	42	60	72	10	*1
9	14.2	24	9	42	60	75	10	*1
10	15.5	24	10	42	60	79	10	*1
11	16.7	24	11	42	60	82	10	*1
12	18	24	12	42	60	88	10	*1
13	19.2	24	13	42	60	92	10	*1
14	20.5	24	14	42	60	97	10	*1
15	21.7	29	15	42	60	125	10	*2
16	23	29	16	42	60	135	10	*2
17	24.2	29	17	42	60	142	10	*2
18	25.5	29	18	42	60	148	10	*2
19	26.7	29	19	41	60	151	10	*2
21	29.2	29	21	41	60	170	10	*2
22	30.5	29	22	45	65	187	10	*2
23	31.7	29	23	45	65	192	10	*2
24	33	29	24	45	65	202	10	*2
25	34.2	29	25	44	65	210	10	*2
26	35.5	29	26	44	65	218	10	*2
27	36.7	29	27	44	65	231	10	*2
30	40.5	29	30	44	65	268	10	*2
32	43	29	32	44	65	296	10	*2
33	44.2	29	33	44	65	318	2	*2
34	45.5	29	34	44	65	330	2	*2
36	48	29	36	44	65	350	2	*2

*1 C-Ring=1401C, Pin/O-Ring=1401A/B
*2 C-Ring=1402C, Pin/O-Ring=1402A/B → P254-255

RS14301X/10 Socket Set on Rail Juego de Vasos en Regleta



RS14301X/10	10 Pieces Set/Rail 300mm	(g)
10, 12, 13, 14, 17, 19, 21, 22, 24, 27		1,585

1/2" Impact Sockets



14300M • 14300A ⊖ 6-point Deep Sockets Vasos Hexagonales Largos

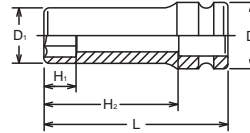

14300M (mm)	D ₁ (mm)	D ₂ (mm)	H ₁ (mm)	H ₂ (mm)	L (mm)	⚖️ (g)	📦 (pcs.)	⊖
8	14.5	25	8	62	80	137	10	*1
9	15.7	25	9	62	80	138	10	*1
10	17	25	10	62	80	140	10	*1
11	18.2	25	11	62	80	156	10	*1
12	19.5	25	12	62	80	162	10	*1
13	20.7	25	13	62	80	162	10	*1
14	22	25	14	62	80	174	10	*1
15	23.2	30	15	62	80	220	10	*2
16	24.5	30	16	62	80	232	10	*2
17	25.7	30	17	62	80	232	10	*2
18	27	30	18	62	80	232	10	*2
19	28.2	30	19	61	80	240	10	*2
20	29.5	30	20	61	80	265	10	*2
21	30.7	30	21	61	80	265	10	*2
22	32	30	22	65	85	290	10	*2
23	33.2	30	23	65	85	300	10	*2
24	34.5	30	24	65	85	329	10	*2
25	35.7	30	25	65	85	345	10	*2
26	37	30	26	64	85	350	10	*2
27	38.2	30	27	64	85	385	10	*2
28	39.5	30	28	64	85	390	10	*2
29	40.7	30	29	63	85	416	10	*2
30	42	30	30	63	85	457	10	*2
31	43.2	30	31	63	85	505	10	*2
32	44.5	30	32	63	85	542	10	*2
33	45.7	30	33	62	85	562	2	*2
34	47	30	33	62	85	570	2	*2
35	48.2	30	35	62	85	600	2	*2
36	49.5	30	36	61	85	635	2	*2
38	52	30	38	60	85	655	2	*2
41	55.7	30	38	60	85	686	2	*2

*1 C-Ring=1401C, Pin/O-Ring=1401A/B → P254-255
*2 C-Ring=1402C, Pin/O-Ring=1402A/B

14300A (inch)	D ₁ (mm)	D ₂ (mm)	H ₁ (mm)	H ₂ (mm)	L (mm)	⚖️ (g)	📦 (pcs.)	⊖
5/16	14.5	25	8	62	80	137	10	*1
3/8	17	25	10	62	80	140	10	*1
7/16	18.2	25	11	62	80	156	10	*1
1/2	20.7	25	13	62	80	162	10	*1
9/16	22	25	14	62	80	174	10	*1
5/8	24.5	30	16	62	80	232	10	*2
11/16	25.7	30	17	62	80	232	10	*2
3/4	28.2	30	19	61	80	259	10	*2
13/16	30.7	30	21	61	80	265	10	*2
7/8	32	30	22	65	85	290	10	*2
15/16	34.5	30	24	65	85	329	10	*2
1	35.7	30	25	65	85	345	10	*2
1. 1/16	38.2	30	27	64	85	385	10	*2
1. 1/8	40.7	30	29	63	85	416	10	*2
1. 3/16	42	30	30	63	85	457	10	*2
1. 1/4	44.5	30	32	63	85	542	10	*2
1. 7/16	50.7	30	37	61	85	580	2	*2
1. 1/2	52	30	38	61	85	600	2	*2

*1 C-Ring=1401C, Pin/O-Ring=1401A/B → P254-255
*2 C-Ring=1402C, Pin/O-Ring=1402A/B



14301M • 14301A ⊖ 6-point Deep Sockets, Thin-walled Vasos Hexagonales Largos de Pared Delgada

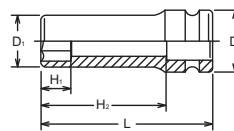

14301M (mm)	D ₁ (mm)	D ₂ (mm)	H ₁ (mm)	H ₂ (mm)	L (mm)	⚖️ (g)	📦 (pcs.)	⊖
8	13	24	8	62	80	87	10	*1
9	14.2	24	9	62	80	92	10	*1
10	15.5	24	10	62	80	98	10	*1
11	16.7	24	11	62	80	104	10	*1
12	18	24	12	62	80	111	10	*1
13	19.2	24	13	62	80	120	10	*1
14	20.5	24	14	62	80	127	10	*1
15	21.7	29	15	62	80	169	10	*2
16	23	29	16	62	80	173	10	*2
17	24.2	29	17	62	80	182	10	*2
18	25.5	29	18	62	80	192	10	*2
19	26.7	29	19	61	80	197	10	*2
20	28	29	20	61	80	203	10	*2
21	29.2	29	21	61	80	218	10	*2
22	30.5	29	22	65	85	244	10	*2
23	31.7	29	23	65	85	253	10	*2
24	33	29	24	65	85	261	10	*2
25	34.2	29	25	65	85	282	10	*2
26	35.5	29	26	64	85	299	10	*2
27	36.7	29	27	64	85	314	10	*2
28	38	29	29	64	85	273	10	*2
29	39.2	29	29	63	85	280	10	*2
30	40.5	29	30	63	85	360	10	*2
31	41.7	29	31	63	85	370	10	*2
32	43	29	32	63	85	380	10	*2
34	45.5	29	34	62	85	411	2	*2
35	46.7	29	35	62	85	450	2	*2
36	48	29	36	61	85	460	2	*2
38	50.5	29	38	61	85	508	2	*2
41	54.2	29	38	60	85	552	2	*2

*1 C-Ring=1401C, Pin/O-Ring=1401A/B → P254-255
*2 C-Ring=1402C, Pin/O-Ring=1402A/B

14301A (inch)	D ₁ (mm)	D ₂ (mm)	H ₁ (mm)	H ₂ (mm)	L (mm)	⚖️ (g)	📦 (pcs.)	⊖
3/8	15.5	24	10	62	80	98	10	*1
7/16	16.7	24	11	62	80	104	10	*1
1/2	19.2	24	13	62	80	120	10	*1
9/16	20.5	24	14	62	80	127	10	*1
5/8	23	29	16	62	80	173	10	*2
11/16	24.2	29	17	62	80	182	10	*2
3/4	26.7	29	19	61	80	197	10	*2
13/16	29.2	29	21	61	80	218	10	*2
7/8	30.5	29	22	65	85	244	10	*2
15/16	33	29	24	65	85	261	10	*2
1. 1/16	36.7	29	27	64	85	314	10	*2
1. 1/8	39.2	29	29	63	85	349	10	*2

*1 C-Ring=1401C, Pin/O-Ring=1401A/B → P254-255
*2 C-Ring=1402C, Pin/O-Ring=1402A/B

Z-SERIES
HAND
MANUALES
TITANIUM
DE TITANIO
ACCESSORIES
ACCESORIOS
SCREWDRIVERS
DESTORNILLADORES
IMPACT
DE IMPACTO
SLEEVE-DRIVE
INDUSTRIAL
INDUSTRIALES
PROTECTOR
PROTECTORES
AUTOMOTIVE
CONSTRUCTION
CONSTRUCCION
RENEWAL KITS
JUEGOS DE HERRAMIENTAS

Impact Sockets 1/2"

Z-SERIES
HAND MANUALES
TITANIUM DE TITANIO
ACCESSORIES ACCESORIOS
IMPACT DE IMPACTO
SLEEVE-DRIVE
INDUSTRIAL INDUSTRIALES
PROTECTOR PROTECTORES
AUTOMOTIVE
CONSTRUCTION CONSTRUCCIÓN
RENEWAL KITS JUEGOS DE PIEZAS/REPUESTO

14305M 12-point Deep Sockets Vasos Bihexagonales Largos

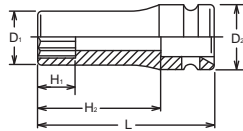

14306M 12-point Deep Sockets, Thin-Walled Vasos Bihexagonales Largos de Pared Delgada

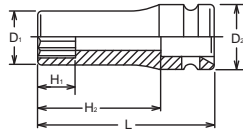

14310M Surface Drive Sockets, Deep Vasos Surface Drive (de Contacto Curvo) Largos

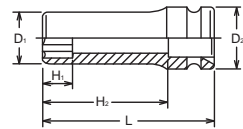

SURFACE DRIVE

Surface drive sockets are designed to retain contact with flat sides of nut to transmit high torque and reduce nut wear. These sockets are ideal for use on polished nuts, aluminum nuts and nuts with worn out points.

Los vasos de contacto curvo se diseñan para mantener el contacto con las caras planas de la tuerca y transmitir un alto par reduciendo el desgaste de la tuerca. Estos vasos son ideales para utilizarse en tuercas pulidas, tuercas de aluminio y tuercas con puntas gastadas.

14305M (mm)	D ₁ (mm)	D ₂ (mm)	H ₁ (mm)	H ₂ (mm)	L (mm)	(g)	(pcs.)	
8	14.5	25	8	62	80	137	10	*1
10	17	25	10	62	80	140	10	*1
11	18.2	25	11	62	80	156	10	*1
12	19.5	25	12	62	80	162	10	*1
13	20.7	25	13	62	80	162	10	*1
14	22	25	14	62	80	174	10	*1
15	23.2	30	15	62	80	220	10	*2
16	24.5	30	16	62	80	232	10	*2
17	25.7	30	17	62	80	232	10	*2
18	27	30	18	62	80	232	10	*2
19	28.2	30	19	61	80	259	10	*2
20	29.5	30	20	61	80	265	10	*2
21	30.7	30	21	61	80	265	10	*2
22	32	30	22	65	85	290	10	*2
23	33.2	30	23	65	85	300	10	*2
24	34.5	30	24	65	85	329	10	*2
26	37	30	26	64	85	350	10	*2
27	38.2	30	27	64	85	385	10	*2
28	39.5	30	30	64	85	390	10	*2
29	40.7	30	29	63	85	416	10	*2
30	42	30	30	63	85	457	10	*2
32	44.5	30	32	63	85	542	10	*2
33	45.7	30	33	62	85	562	2	*2
36	49.5	30	36	61	85	635	2	*2

*1 C-Ring=1401C, Pin/O-Ring=1401A/B
*2 C-Ring=1402C, Pin/O-Ring=1402A/B

14306M (mm)	D ₁ (mm)	D ₂ (mm)	H ₁ (mm)	H ₂ (mm)	L (mm)	(g)	(pcs.)	
8	13	24	8	62	80	88	10	*1
10	15.5	24	10	62	80	98	10	*1
11	16.7	24	11	62	80	105	10	*1
12	18	24	12	62	80	111	10	*1
13	19.2	24	13	62	80	120	10	*1
14	20.5	24	14	62	80	127	10	*1
15	21.7	29	15	62	80	169	10	*2
16	23	29	16	62	80	173	10	*2
17	24.2	29	17	62	80	182	10	*2
18	25.5	29	18	62	80	192	10	*2
19	26.7	29	19	61	80	197	10	*2
21	29.2	29	21	61	80	218	10	*2
22	30.5	29	22	65	85	244	10	*2
24	33	29	24	65	85	261	10	*2
26	35.5	29	26	64	85	290	10	*2
27	36.7	29	27	64	85	314	10	*2
30	40.5	29	30	63	85	360	10	*2
32	43	29	32	63	85	380	10	*2

*1 C-Ring=1401C, Pin/O-Ring=1401A/B
*2 C-Ring=1402C, Pin/O-Ring=1402A/B

14310M (mm)	D ₁ (mm)	D ₂ (mm)	H ₁ (mm)	H ₂ (mm)	L (mm)	(g)	(pcs.)	
10	17	25	10	62	80	136	10	*1
11	18.2	25	11	62	80	148	10	*1
12	19.5	25	12	62	80	156	10	*1
13	20.7	25	13	62	80	158	10	*1
14	22	25	14	62	80	170	10	*1
15	23.2	30	15	62	80	225	10	*2
16	24.5	30	16	62	80	228	10	*2
17	25.7	30	17	62	80	232	10	*2
18	27	30	18	62	80	232	10	*2
19	28.2	30	19	61	80	252	10	*2
20	29.5	30	20	61	80	260	10	*2
21	30.7	30	21	61	80	260	10	*2
22	32	30	22	65	85	290	10	*2
23	33.2	30	23	65	85	300	10	*2
24	34.5	30	24	65	85	322	10	*2
25	35.7	30	25	65	85	338	10	*2
26	37	30	26	64	85	350	10	*2
27	38.2	30	27	64	85	380	10	*2
28	39.5	30	28	64	85	390	10	*2
30	42	30	30	63	85	450	10	*2
32	44.5	30	32	63	85	535	10	*2
34	47	30	34	62	85	563	2	*2
36	49.5	30	36	61	85	630	2	*2

*1 C-Ring=1401C, Pin/O-Ring=1401A/B
*2 C-Ring=1402C, Pin/O-Ring=1402A/B

14300G (mm)	D ₁ (mm)	D ₂ (mm)	H ₁ (mm)	H ₂ (mm)	L (mm)	(g)	(pcs.)	
10	17	25	4.5	26	80	139	10	*1
12	19.5	25	6	26	80	165	10	*1
13	20.7	25	6.5	25	80	185	10	*1
14	22	25	7	24	80	189	10	*1
15	23.2	30	7	24	80	240	10	*2
16	24.5	30	7.5	26.5	80	270	10	*2
17	25.7	30	8	26.5	80	272	10	*2
18	27	30	8.5	26.5	80	290	10	*2
19	28.2	30	9	27.5	80	308	10	*2

*1 C-Ring=1401C, Pin/O-Ring=1401A/B

*2 C-Ring=1402C, Pin/O-Ring=1402A/B

→ P254-255



14300G Impact Socket with Sliding Magnet

Vasos de Impacto con Imán Corredizo

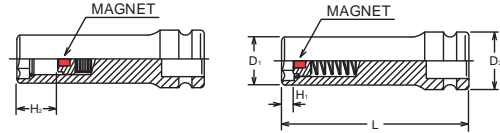

14365M (mm)	D ₁ (mm)	D ₂ (mm)	H ₁ (mm)	H ₂ (mm)	L (mm)	(g)	(pcs.)	
10	17	25	8	62	80	138	10	*1
11	18.2	25	8	62	80	144	10	*1
12	19.5	25	9	62	80	165	10	*1
13	20.7	25	9	62	80	170	10	*1
14	22	25	11	62	80	178	10	*1
15	23.2	30	11	62	80	237	10	*2
16	24.5	30	11	62	80	245	10	*2
17	25.7	30	12	62	80	263	10	*2
18	27	30	13	62	80	268	10	*2
19	28.2	30	13	61	80	270	10	*2
20	29.5	30	14	61	80	274	10	*2
21	30.7	30	14	61	80	287	10	*2
22	32	30	15	65	85	314	10	*2
23	33.2	30	15	65	85	320	10	*2
24	34.5	30	15	65	85	335	10	*2
26	37	30	15	64	85	388	10	*2
27	38.2	30	16	64	85	407	10	*2

*1 C-Ring=1401C, Pin/O-Ring=1401A/B

*2 C-Ring=1402C, Pin/O-Ring=1402A/B

→ P254-255



14365M Pathfinder Sockets, Deep

Vasos Pathfinder (Guía) Largos

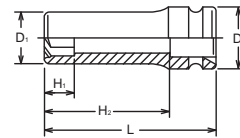

14325 (E)	D ₁ (mm)	D ₂ (mm)	H ₁ (mm)	H ₂ (mm)	L (mm)	(g)	(pcs.)	
E10	14.2	25	8.2	62	80	136	10	*1
E12	15.2	25	9.3	62	80	141	10	*1
E14	18.2	25	10.6	62	80	147	10	*1
E16	19.2	25	11.8	62	80	151	10	*1
E18	22.2	25	13	62	80	218	10	*1
E20	24.2	30	14.4	62	80	225	10	*2

*1 C-Ring=1401C, Pin/O-Ring=1401A/B

*2 C-Ring=1402C, Pin/O-Ring=1402A/B

→ P254-255

14325 TORX® Deep Sockets

Vasos TORX® Largos

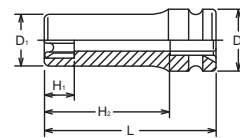

14440M (mm)	D (mm)	H (mm)	L (mm)	(g)	(pcs.)	
13	20.7	6	67.5	210	10	*2
14	22	7	69.5	210	10	*2
15	23.2	7	69.5	210	10	*2
16	24.5	8	69.5	206	10	*2
17	25.7	8	69.5	220	10	*2
18	27	9	69.5	218	10	*2
19	28.2	10	73.5	260	10	*2
20	29.5	10	73.5	270	10	*2
21	30.7	11	73.5	280	10	*2
22	32	13	73.5	290	10	*2
24	34.5	14	73.5	300	10	*2

14440A (inch)	D (mm)	H (mm)	L (mm)	(g)	(pcs.)	
1/2	20.7	6	67.5	210	10	*2
9/16	22	7	69.5	210	10	*2
5/8	24.5	8	69.5	206	10	*2
11/16	25.7	8	69.5	220	10	*2
3/4	28.2	10	73.5	260	10	*2

*2 C-Ring=1402C, Pin/O-Ring=1402A/B

→ P254-255

14440M • 14440A Universal Sockets

Vasos con Articulación Universal

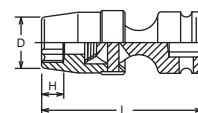

Z-SERIES
HAND
MANUALES
TITANIUM
DE TITANIO
ACCESSORIES
ACCESORIOS
SCREWDRIVERS
DESTORNILLADORES
IMPACT
DE IMPACTO
SLEEVE-DRIVE
INDUSTRIAL
INDUSTRIALES
PROTECTOR
PROTECTORES
AUTOMOTIVE
CONSTRUCTION
CONSTRUCCION
RENEWAL KITS
JUEGOS DE HERRAMIENTAS

Impact Sockets 1/2"

Z-SERIES
HAND MANUALES
TITANIUM DE TITANIO
ACCESSORIES ACCESORIOS
SCREWDRIVERS DESTORNILLADORES
IMPACT DE IMPACTO
SLEEVE-DRIVE
INDUSTRIAL INDUSTRIALES
PROTECTOR PROTECTORES
AUTOMOTIVE
CONSTRUCTION CONSTRUCCIÓN
RENEWAL KITS JUEGOS DE PIEZAS REPUESTO

14012M-60 Inhex Sockets Vasos Inhex



14012M.60 (mm)	D (mm)	H ₁ (mm)	H ₂ (mm)	L (mm)	(g)	(pcs.)	
4	25	15.5	38	60	68	10	*1
5	25	15.5	38	60	71	10	*1
6	25	15.5	38	60	74	10	*1
7	25	15.5	38	60	80	10	*1
8	25	15.5	38	60	84	10	*1
10	30	15.5	38	60	140	10	*2
12	30	15.5	38	60	150	10	*2
14	30	15.5	38	60	170	10	*2
16	30	15.5	38	60	180	10	*2
17	30	15.5	38	60	190	10	*2
19	30	15.5	38	60	210	10	*2

*1 C-Ring=1401C, Pin/O-Ring=1401A/B → P254-255
*2 C-Ring=1402C, Pin/O-Ring=1402A/B

RS14012M/10-L60 Socket Set on Rail Juego de Vasos en Regleta



RS14012M/10-L60	10 Pieces Set/Rail 300mm	(g)
4, 5, 6, 7, 8, 10, 12, 14, 17, 19		1,300

14025-60 · -100 TORX® Bit Sockets Vasos con Punta TORX®



14025.100 (T)	D (mm)	H (mm)	L (mm)	(g)	(pcs.)	
T30	25	73.5	100	85	10	*1
T40	25	73.5	100	95	10	*1
T45	25	73.5	100	102	10	*1
T50	25	73.5	100	120	10	*1
T55	25	73.5	100	155	10	*1
T60	30	73.5	100	220	10	*2

14025.60 (T)	D (mm)	H (mm)	L (mm)	(g)	(pcs.)	
T20	25	23.5	60	75	10	*1
T25	25	23.5	60	75	10	*1
T27	25	23.5	60	75	10	*1
T30	25	23.5	60	80	10	*1
T40	25	23.5	60	85	10	*1
T45	25	23.5	60	85	10	*1
T50	25	23.5	60	95	10	*1
T55	25	23.5	60	110	10	*1
T60	30	23.5	60	160	10	*2

*1 C-Ring=1401C, Pin/O-Ring=1401A/B → P254-255
*2 C-Ring=1402C, Pin/O-Ring=1402A/B

RS14025/6-L60 Socket Set on Rail Juego de Vasos en Regleta



RS14025/6-L60	6 Pieces Set/Rail 200mm	(g)
T30, T40, T45, T50, T55, T60		650

	D ₁ (mm)	D ₂ (mm)	L (mm)	(g)	(pcs.)	
14134	22.5	25	38	90	10	*1

*1 C-Ring=1401C, Pin/O-Ring=1401A/B → P254-255

 Replacement Screw : M8x5, ● 4mm

14134 Impact Bit Holder Porta-punta de Impacto

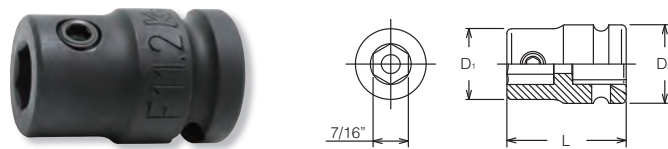

For DIN3126 / ISO1173 E11.2 Bits

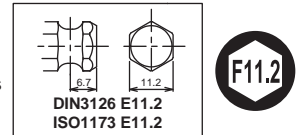

	D ₁ (mm)	D ₂ (mm)	L (mm)	(g)	(pcs.)	
14142-F11.2	18.9	25	46	207	10	*1

*1 C-Ring=1401C, Pin/O-Ring=1401A/B → P254-255

14142-F11.2 Impact Bit Holder (Quick Release) Porta-punta de Impacto (Extracción Rápida)

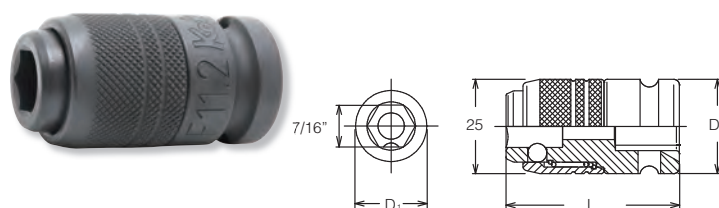

For DIN3126 / ISO1173 E11.2 Bits

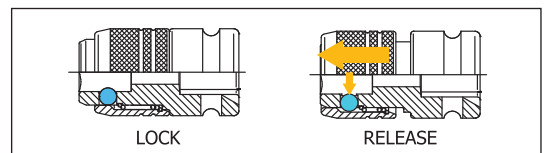
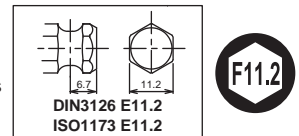

 You may not hold the sliding part while moving to avoid heating up by friction and reduction by wear.

183H.35 (inch)	L (mm)	(g)	(pcs.)
3/16	35	15	10
7/32	35	16	10
1/4	35	18	10
5/16	35	20	10
3/8	35	26	10
7/16	35	28	10
1/2	35	38	10

183H-35 · -75 · -150

Hex Bits
Puntas Hexagonales

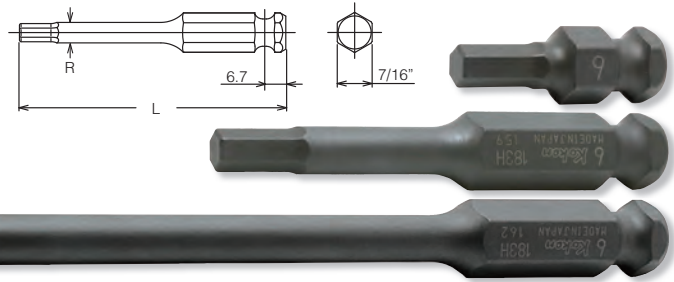

183H.35 (mm)	L (mm)	(g)	(pcs.)
3	35	15	10
4	35	15	10
5	35	15	10
6	35	18	10
7	35	19	10
8	35	20	10
10	35	26	10
11	35	28	10
12	35	30	10
14	35	35	10
16	35	47	10
17	35	50	10
18	35	53	10
19	35	56	10

183H.75 (mm)	L (mm)	R (mm)	(g)	(pcs.)
3	75	6	34	10
4	75	6	35	10
5	75	6.5	36	10
6	75	7.5	39	10
7	75	8.5	44	10
8	75	9.5	47	10
10	75	-	57	10
11	75	-	60	10
12	75	-	65	10
14	75	-	79	10

183H.150 (mm)	L (mm)	R (mm)	(g)	(pcs.)
4	150	6	51	10
5	150	6.5	55	10
6	150	7.5	65	10
8	150	9.5	87	10
10	150	-	118	10
12	150	-	136	10

183T.35 (T)	L (mm)	(g)	(pcs.)
T25	35	18	10
T30	35	18	10
T40	35	20	10
T45	35	22	10
T50	35	26	10
T55	35	30	10
T60	35	38	10

183T-35 · -75 · -150 (T)

TORX® Bits
Puntas TORX®

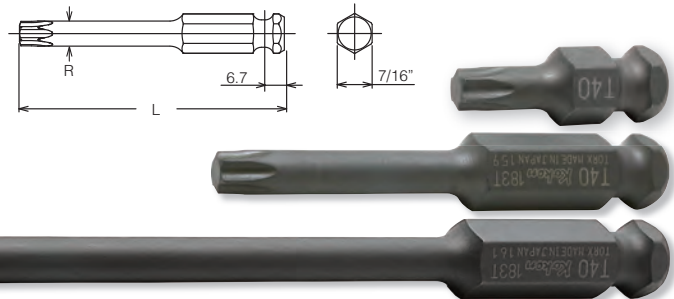

183T.150 (T)	L (mm)	R (mm)	(g)	(pcs.)
T30	150	6	50	10
T40	150	6.9	58	10
T45	150	8	70	10
T50	150	9	82	10
T55	150	11.4	113	10

183T.75 (T)	L (mm)	R (mm)	(g)	(pcs.)
T30	75	6	35	10
T40	75	6.9	37	10
T45	75	8	41	10
T50	75	9	45	10
T55	75	11.4	55	10
T60	75	13.5	67	10

183T.35 (IP)	L (mm)	(g)	(pcs.)
30IP	35	18	10
40IP	35	20	10
45IP	35	22	10
50IP	35	26	10
55IP	35	30	10
60IP	35	38	10

183T-35 · -75 (IP)

TORXPLUS® Bits
Puntas TORXPLUS®

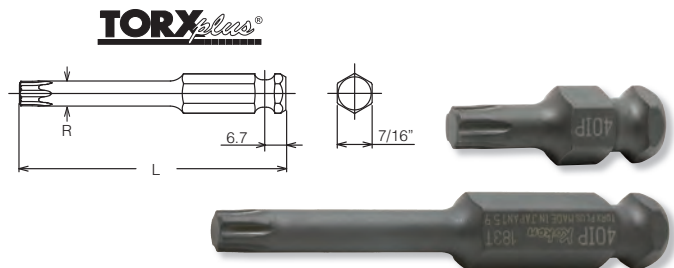

183T.75 (IP)	L (mm)	R (mm)	(g)	(pcs.)
30IP	75	6	35	10
40IP	75	6.8	37	10
45IP	75	8	41	10
50IP	75	9	45	10
55IP	75	11.4	56	10
60IP	75	13.5	67	10

TORX is a registered trademark of Acument Intellectual Properties, LLC.
TORX es una marca registrada de Acument Intellectual Properties, LLC.
TORXplus is a registered trademark of Acument Intellectual Properties, LLC.
TORXplus es una marca registrada de Acument Intellectual Properties, LLC.

Z-SERIES
HAND
MANUALES
TITANIUM
DE TITANIO
ACCESSORIES
ACCESORIOS
SCREWDRIVERS
DESTORNILLADORES
IMPACT
DE IMPACTO
SLEEVE-DRIVE
INDUSTRIAL
INDUSTRIALES
PROTECTOR
PROTECTORES
AUTOMOTIVE
CONSTRUCTION
CONSTRUCCION
RENEWAL KITS
JUEGOS DE PIEZAS/REPLUSTO

Impact Sockets **1/2"**

Z-SERIES
HAND MANUALES
TITANIUM DE TITANIO
ACCESSORIES ACCESORIOS
SCREWDRIVERS DESTORNILLADORES
IMPACT DE IMPACTO
SLEEVE-DRIVE
INDUSTRIAL INDUSTRIALES
PROTECTOR PROTECTORES
AUTOMOTIVE
CONSTRUCTION CONSTRUCCIÓN
RENEWAL KITS JUEGOS DE PIEZAS REPUESTO

183X-35 · -75 · -150 (XZN)

XZN Bits
Puntas XZN

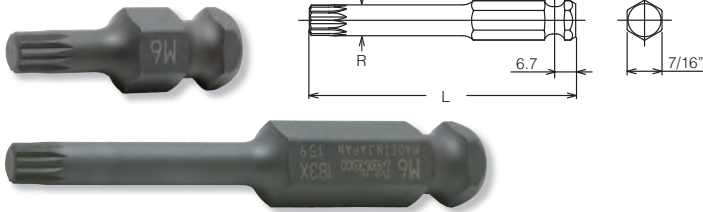

183X.75 (XZN)	L (mm)	R (mm)	(g)	(pcs.)
M 4	75	6	34	10
M 5	75	6	34	10
M 6	75	6.2	36	10
M 8	75	7.4	39	10
M10	75	9.8	54	10
M12	75	11.7	57	10
M14	75	13.5	67	10

183X.35 (XZN)	L (mm)	(g)	(pcs.)
M 4	35	18	10
M 5	35	18	10
M 6	35	20	10
M 8	35	22	10
M10	35	26	10
M12	35	30	10
M14	35	38	10

183X.150 (XZN)	L (mm)	R (mm)	(g)	(pcs.)
M 5	150	6	50	10
M 6	150	6.2	53	10
M 8	150	7.4	64	10
M10	150	9.8	93	10
M12	150	11.7	121	10

14134M-58 · -98

Hex Bit Sockets
Vasos con Punta Hexagonal



14134M-58/-98 (mm)	D (mm)	H (mm)	L (mm)	L (mm)	R (mm)	L=58 (g)	L=98 (g)	L=58 (pcs.)	L=98 (pcs.)	(V)
3	25	20.6	58	98	6	105	124	10	5	*1
4	25	20.6	58	98	6	105	125	10	5	*1
5	25	20.6	58	98	6.5	105	126	10	5	*1
6	25	20.6	58	98	7.5	108	129	10	5	*1
8	25	20.6	58	98	9.5	110	137	10	5	*1
10	25	20.6	58	98	-	116	147	10	5	*1
12	25	20.6	58	98	-	120	155	10	5	*1
14	25	20.6	58	98	-	125	169	10	5	*1

*1 C-Ring=1401C, Pin/O-Ring=1401A/B → P254-255

14134T-58 · -98 (T)

TORX® Bit Sockets
Vasos con Punta TORX®



14134T-58/-98 (T)	D (mm)	H (mm)	L (mm)	L (mm)	R (mm)	L=58 (g)	L=98 (g)	L=58 (pcs.)	L=98 (pcs.)	(V)
T30	25	20.6	58	98	6	108	125	10	5	*1
T40	25	20.6	58	98	6.9	110	127	10	5	*1
T45	25	20.6	58	98	8	112	131	10	5	*1
T50	25	20.6	58	98	9	116	135	10	5	*1
T55	25	20.6	58	98	11.4	120	145	10	5	*1
T60	25	20.6	58	98	13.5	128	157	10	5	*1

*1 C-Ring=1401C, Pin/O-Ring=1401A/B → P254-255

14134T-58 · -98 (IP)

TORXPLUS® Bit Sockets
Vasos con Punta TORXPLUS®



14134T-58/-98 (IP)	D (mm)	H (mm)	L (mm)	L (mm)	R (mm)	L=58 (g)	L=98 (g)	L=58 (pcs.)	L=98 (pcs.)	(V)
30IP	25	20.6	58	98	6	108	125	10	5	*1
40IP	25	20.6	58	98	6.8	110	127	10	5	*1
45IP	25	20.6	58	98	8	112	131	10	5	*1
50IP	25	20.6	58	98	9	116	135	10	5	*1
55IP	25	20.6	58	98	11.4	120	146	10	5	*1
60IP	25	20.6	58	98	13.5	128	159	10	5	*1

*1 C-Ring=1401C, Pin/O-Ring=1401A/B → P254-255

14134X-58 · -98 (XZN)

XZN Bit Sockets
Vasos con Punta XZN



14134X-58/-98 (XZN)	D (mm)	H (mm)	L (mm)	L (mm)	R (mm)	L=58 (g)	L=98 (g)	L=58 (pcs.)	L=98 (pcs.)	(V)
M 5	25	20.6	58	98	6	108	124	10	5	*1
M 6	25	20.6	58	98	6.2	110	126	10	5	*1
M 8	25	20.6	58	98	7.4	112	129	10	5	*1
M10	25	20.6	58	98	9.8	116	144	10	5	*1
M12	25	20.6	58	98	11.7	120	149	10	5	*1
M14	25	20.6	58	98	13.5	128	159	10	5	*1

*1 C-Ring=1401C, Pin/O-Ring=1401A/B → P254-255

TORX is a registered trademark of Acument Intellectual Properties, LLC.
TORX es una marca registrada de Acument Intellectual Properties, LLC.
TORXplus is a registered trademark of Acument Intellectual Properties, LLC.
TORXplus es una marca registrada de Acument Intellectual Properties, LLC.

	D ₁ (mm)	D ₂ (mm)	L (mm)	(g)	(pcs.)	
14106	28	30	43	160	10	*2

*2 C-Ring=1402C, Pin/O-Ring=1402A/B → P254-255



107.16 (mm)	L (mm)	(g)	(pcs.)
10	40	46	10
12	40	52	10
13	40	56	10
14	40	60	10
16	40	69	10
17	40	73	10
18	40	78	10
19	40	80	10
22	40	97	10

107.16 (inch)	L (mm)	(g)	(pcs.)
3/8	40	45	10
1/2	40	56	10
9/16	40	60	10
5/8	40	69	10
3/4	40	80	10

107.16(L100) (mm)	L (mm)	R (mm)	(g)	(pcs.)
10	100	13	122	10
12	100	15	146	10
14	100	-	166	10
17	100	-	193	10
19	100	-	232	10
22	100	-	254	10

107.16 (T)	L (mm)	(g)	(pcs.)
T55	50	57	10
T60	50	64	10
T70	50	73	10

107.16(L100) (T)	L (mm)	R (mm)	(g)	(pcs.)
T55	100	11.4	108	10
T60	100	13.4	130	10
T70	100	15.7	159	10

107.16 (IP)	L (mm)	(g)	(pcs.)
55IP	50	57	10
60IP	50	64	10
70IP	50	73	10

107.16 (XZN)	L (mm)	(g)	(pcs.)
M14	60	83	10
M16	60	93	10
M18	60	103	10

107.16(L100) (XZN)	L (mm)	R (mm)	(g)	(pcs.)
M14	100	13.4	131	10
M16	100	15.8	161	10
M18	100	17.1	177	10

14106 ○ Bit Holder for 107-16 Porta Punta

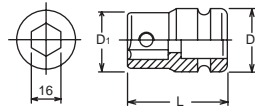

107-16 ○ Bits for Inhex screws Puntas para Tornillos Inhex

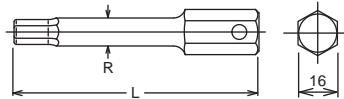
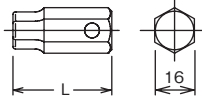

107-16 (T) ☆ TORX® Bits Puntas TORX®

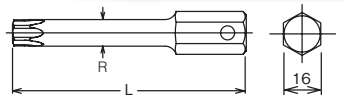
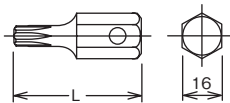

107-16 (IP) ☆ TORXPLUS® Bits Puntas TORXPLUS®

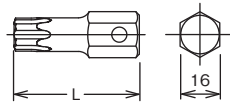

107-16 (XZN) ○ XZN Bits Puntas XZN

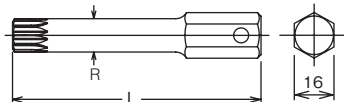
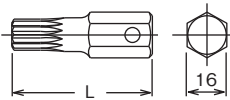

TORX is a registered trademark of Acument Intellectual Properties, LLC.
TORX es una marca registrada de Acument Intellectual Properties, LLC.
TORXPLUS is a registered trademark of Acument Intellectual Properties, LLC.
TORXPLUS es una marca registrada de Acument Intellectual Properties, LLC.

Z-SERIES
HAND
MANUALES
TITANIUM
DE TITANIO
ACCESSORIES
ACCESORIOS
SCREWDRIVERS
DESTORNILLADORES
IMPACT
DE IMPACTO
SLEEVE-DRIVE
INDUSTRIAL
INDUSTRIALES
PROTECTOR
PROTECTORES
AUTOMOTIVE
CONSTRUCTION
CONSTRUCCION
RENEWAL KITS
JUEGOS DE PIEZAS REPUESTO

Impact Sockets 1/2"

Z-SERIES
HAND MANUALES
TITANIUM DE TITANIO
SCREWDRIVERS ACCESSORIES DESTORNILLADORES ACCESORIOS
IMPACT DE IMPACTO
SLEEVE-DRIVE
INDUSTRIAL INDUSTRIALES
PROTECTOR PROTECTORES
AUTOMOTIVE
CONSTRUCTION CONSTRUCCIÓN
RENEWAL KITS JUEGOS DE PIEZAS REPUESTO

14145M-100 · -150 · 200 · -250

Extra Long 12-point Sockets
Vasos Bihexagonales, Extra-Largos

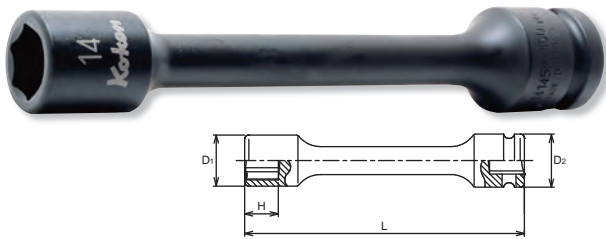

14145M.200 (mm)	D ₁ (mm)	D ₂ (mm)	H (mm)	L (mm)	(g)	(pce.)	
10	17	25	10	200	234	1	*1
12	19.5	25	12	200	248	1	*1
13	20.7	25	13	200	260	1	*1
14	22	25	14	200	272	1	*1
15	23.2	25	15	200	284	1	*1
16	24.5	25	16	200	290	1	*1
17	25.7	25	17	200	297	1	*1
18	27	25	18	200	305	1	*1
19	28.2	25	19	200	311	1	*1

*1 C-Ring=1401C, Pin/O-Ring=1401A/B → P254-255

14145M.100 (mm)	D ₁ (mm)	D ₂ (mm)	H (mm)	L (mm)	(g)	(pce.)	
10	17	25	10	100	155	1	*1
12	19.5	25	12	100	165	1	*1
14	22	25	14	100	180	1	*1
17	25.7	25	17	100	210	1	*1
19	28.2	25	19	100	230	1	*1

14145M.150 (mm)	D ₁ (mm)	D ₂ (mm)	H (mm)	L (mm)	(g)	(pce.)	
10	17	25	10	150	190	1	*1
12	19.5	25	12	150	204	1	*1
13	20.7	25	13	150	216	1	*1
14	22	25	14	150	228	1	*1
15	23.2	25	15	150	240	1	*1
16	24.5	25	16	150	245	1	*1
17	25.7	25	17	150	253	1	*1
18	27	25	18	150	260	1	*1
19	28.2	25	19	150	267	1	*1

14145M.250 (mm)	D ₁ (mm)	D ₂ (mm)	H (mm)	L (mm)	(g)	(pce.)	
10	17	25	10	250	278	1	*1
12	19.5	25	12	250	292	1	*1
13	20.7	25	13	250	304	1	*1
14	22	25	14	250	316	1	*1
15	23.2	25	15	250	328	1	*1
16	24.5	25	16	250	335	1	*1
17	25.7	25	17	250	341	1	*1
18	27	25	18	250	350	1	*1
19	28.2	25	19	250	355	1	*1

*1 C-Ring=1401C, Pin/O-Ring=1401A/B → P254-255

14146M-150 · -200 · -250

Extra Long Universal Sockets
Vasos con Articulación Universal Extra-Largos

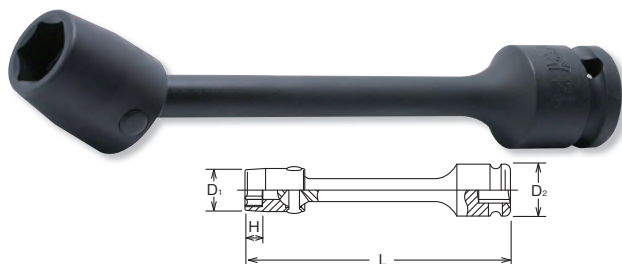

14146M.200 (mm)	D ₁ (mm)	D ₂ (mm)	H (mm)	L (mm)	(g)	(pce.)	
10	16	25	6.5	200	241	1	*1
12	19.3	25	7.5	200	244	1	*1
13	20	25	8	200	245	1	*1
14	21	25	8.5	200	247	1	*1
15	22	25	9	200	245	1	*1
16	23	25	9.5	200	244	1	*1
17	25	25	9.5	200	244	1	*1
18	26	25	11	200	250	1	*1
19	28	25	11.5	200	254	1	*1

*1 C-Ring=1401C, Pin/O-Ring=1401A/B → P254-255

14146M.150 (mm)	D ₁ (mm)	D ₂ (mm)	H (mm)	L (mm)	(g)	(pce.)	
10	16	25	6.5	150	197	1	*1
12	19.3	25	7.5	150	200	1	*1
13	20	25	8	150	201	1	*1
14	21	25	8.5	150	203	1	*1
15	22	25	9	150	201	1	*1
16	23	25	9.5	150	200	1	*1
17	25	25	9.5	150	200	1	*1
18	26	25	11	150	210	1	*1
19	28	25	11.5	150	210	1	*1

14146M.250 (mm)	D ₁ (mm)	D ₂ (mm)	H (mm)	L (mm)	(g)	(pce.)	
10	16	25	6.5	250	285	1	*1
12	19.3	25	7.5	250	288	1	*1
13	20	25	8	250	289	1	*1
14	21	25	8.5	250	291	1	*1
15	22	25	9	250	289	1	*1
16	23	25	9.5	250	288	1	*1
17	25	25	9.5	250	288	1	*1
18	26	25	11	250	290	1	*1
19	28	25	11.5	250	299	1	*1

*1 C-Ring=1401C, Pin/O-Ring=1401A/B → P254-255

14147M-150 · -200

Extra Long Universal Inhex Sockets
Vasos Inhex con Articulación Universal Extra-Largos

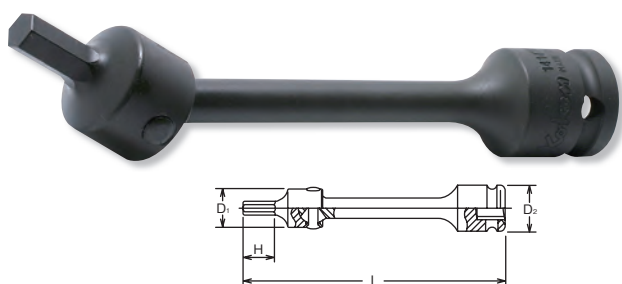

14147M.150 (mm)	D ₁ (mm)	D ₂ (mm)	H (mm)	L (mm)	(g)	(pce.)	
6	25	25	15	150	200	1	*1
8	25	25	15	150	205	1	*1
10	25	25	15	150	210	1	*1
12	25	25	15	150	217	1	*1

14147M.200 (mm)	D ₁ (mm)	D ₂ (mm)	H (mm)	L (mm)	(g)	(pce.)	
6	25	25	15	200	244	1	*1
8	25	25	15	200	249	1	*1
10	25	25	15	200	254	1	*1
12	25	25	15	200	261	1	*1

*1 C-Ring=1401C, Pin/O-Ring=1401A/B → P254-255

14760	D (mm)	L (mm)	(g)	(pcs.)	
50	30	50	150	10	*2
75	30	75	188	10	*2
100	30	100	240	10	*2
125	30	125	275	5	*2
150	30	150	300	5	*2
175	30	175	358	5	*2
200	30	200	405	5	*2
250	30	250	480	1	*2

*2 C-Ring=1402C, Pin/O-Ring=1402A/B → P254-255

14444AL	L (mm)	(g)	(pcs.)	
14444AL	60	128	10	*1

*1 C-Ring=1401C, Pin/O-Ring=1401A/B → P254-255

Lock & Quick Release

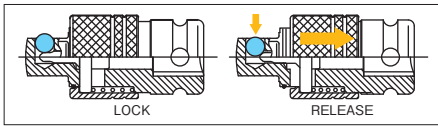

⚠ You may not hold the sliding part while moving to avoid heating up by friction and reduction by wear.



	L (mm)	(g)	(pcs.)	
14770	74	210	5	*2
14770-B	74	210	5	*2
14770-P	74	210	5	*2
14771	65	198	5	*2
14771-B	65	198	5	*2
14771-P	65	198	5	*2

*2 C-Ring=1402C, Pin/O-Ring=1402A/B → P254-255

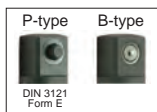
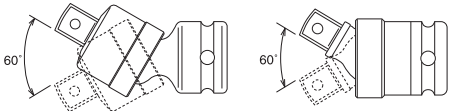

	D ₁ (mm)	D ₂ (mm)	L (mm)	(g)	(pcs.)	
14772-B	27	25	90	230	5	*1
14772-P	27	25	90	230	5	*1

*1 C-Ring=1401C, Pin/O-Ring=1401A/B → P254-255

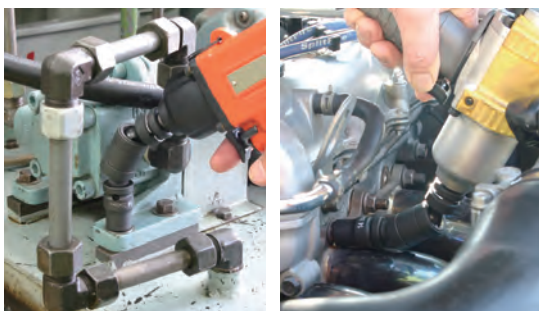

⚠ 13772 and 14772 have less load capacity than standard. In the interest of your safety always use properly.

14760 Extension Bars Alargaderas

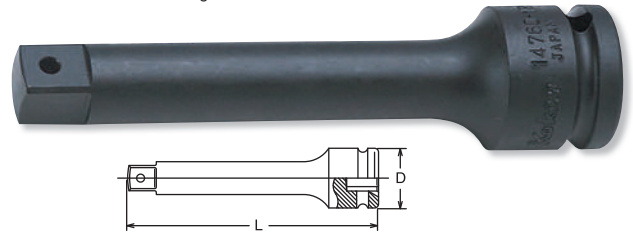

14444AL Adaptor (Quick Release) Adaptador (Extracción Rápida)



LOCKING ADAPTOR

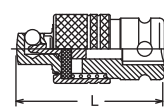

14770 Universal Joint Articulación Universal

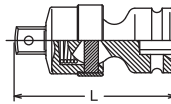

14771 Universal Joint Articulación Universal

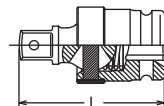

14772 Universal Double Joint Articulación Universal



UNIVERSAL DOUBLE JOINT

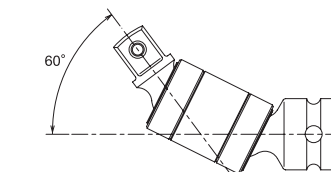
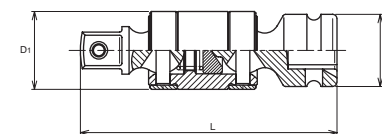

Z-SERIES
HAND
MANUALES
TITANIUM
DE TITANIO
ACCESSORIES
ACCESORIOS
SCREWDRIVERS
DESTORNILLADORES
IMPACT
DE IMPACTO
SLEEVE-DRIVE
INDUSTRIAL
INDUSTRIALES
PROTECTOR
PROTECTORES
AUTOMOTIVE
CONSTRUCTION
CONSTRUCCION
RENEWAL KITS
JUEGOS DE REPARACION

Impact Sockets **1/2"**

Z-SERIES
HAND MANUALES
TITANIUM DE TITANIO
ACCESSORIES ACCESORIOS
SCREWDRIVERS DESTORNILLADORES
IMPACT DE IMPACTO
SLEEVE-DRIVE
INDUSTRIAL INDUSTRIALES
PROTECTOR PROTECTORES
AUTOMOTIVE
CONSTRUCTION CONSTRUCCIÓN
RENEWAL KITS JUEGOS DE PIEZAS/REPUÉSTO

14433A Adaptor Adaptador

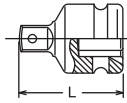

14455A Adaptor Adaptador

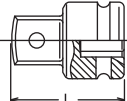

14466A Adaptor Adaptador

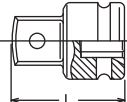

14209M Socket Set Juego de Vasos



14210M Socket Set Juego de Vasos



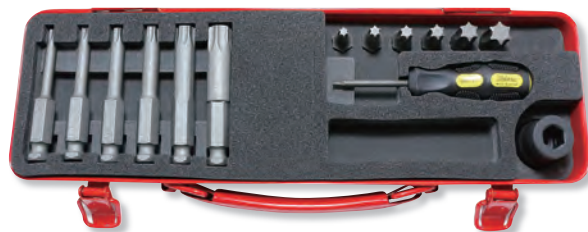

14210T Socket Set Juego de Vasos

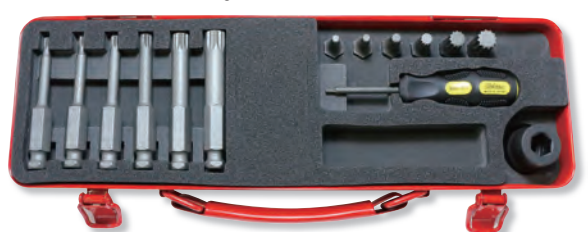

14210X Socket Set Juego de Vasos



	 (sq.)	 (sq.)	L (mm)	 (g)	 (pcs.)	
14433A	1/2"	3/8"	37.5	68	10	*1
14433A-B	1/2"	3/8"	37.5	68	10	*1
14433A-P	1/2"	3/8"	37.5	68	10	*1



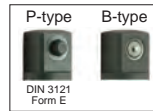

*1 C-Ring=1401C, Pin/O-Ring=1401A/B → P254-255

 Adapting down to a smaller square drive may lead to excessive torque load and possibly cause breakage. Always stay within limit torque of the smaller square drive.













	 (sq.)	 (sq.)	L (mm)	 (g)	 (pcs.)	
14455A	1/2"	5/8"	42	135	10	*2





*2 C-Ring=1402C, Pin/O-Ring=1402A/B → P254-255





	 (sq.)	 (sq.)	L (mm)	 (g)	 (pcs.)	
14466A	1/2"	3/4"	44	146	10	*2
14466A-B	1/2"	3/4"	44	146	10	*2

*2 C-Ring=1402C, Pin/O-Ring=1402A/B → P254-255

14209M		10 Pieces Set/  =830g
METAL CASE: W190xH59xT45mm		
Bits	Bit Holder	
 183H.35 Hex Bits 5, 6, 8, 10	 14134 Bit Holder	
 107.16 Hex Bits 12, 14, 17, 19	 14106 Bit Holder	

14210M		18 Pieces Set/  =1,250g
METAL CASE: W310xH90xT48mm		
Bits	Bit Holder	
 183H.35 Hex Bits 4, 5, 6, 7, 8, 10, 12, 14	 14134 Bit Holder	
 183H.75 Hex Bits 4, 5, 6, 7, 8, 10, 12, 14	 168H-4 (40) Screwdriver	

14210T		14 Pieces Set/  =1,080g
METAL CASE: W310xH90xT48mm		
Bits	Bit Holder	
 183T.35 TORX® Bits T30, T40, T45, T50, T55, T60	 14134 Bit Holder	
 183T.75 TORX® Bits T30, T40, T45, T50, T55, T60	 168H-4 (40) Screwdriver	

14210X		14 Pieces Set/  =1,040g
METAL CASE: W310xH90xT48mm		
Bits	Bit Holder	
 183X.35 XZN Bits M4, M5, M6, M8, M10, M12	 14134 Bit Holder	
 183X.75 XZN Bits M4, M5, M6, M8, M10, M12	 168H-4 (40) Screwdriver	



14207M	10 Pieces Set/△=2,700g
METAL CASE:W310xH90xT48mm	
Sockets	
 14300M 6-pt Deep Sockets	10, 12, 13, 14, 17, 19, 21, 22, 24, 27



14208M	13 Pieces Set/△=3,500g
METAL CASE:W395xH90xT50mm	
Sockets	
 14300M 6-pt Deep Sockets	10, 12, 13, 14, 15, 16, 17, 18, 19, 21, 22, 24, 27

14241M	13 Pieces Set/△=2,000g
METAL CASE:W196xH100xT45mm	
Sockets	
 14400M 6-pt. Sockets	10, 11, 12, 13, 14, 15, 16, 17, 19, 21, 22, 24, 27

14241M-05	13 Pieces Set/△=2,000g
METAL CASE:W196xH100xT45mm	
Sockets	
 14405M 12-pt. Sockets	10, 11, 12, 13, 14, 15, 16, 17, 19, 21, 22, 24, 27

14242M	12 Pieces Set/△=1,890g
METAL CASE:W310xH90xT48mm	
Sockets	
 14400M 6-pt. Sockets	10, 11, 12, 13, 14, 15, 16, 17, 19, 21, 22, 27

14245M-6P	18 Pieces Set/△=2,250g
METAL CASE:W310xH90xT48mm	
Sockets	Accessories
 14400M 6-pt.Sockets	 14760-125
10, 12, 13, 14, 16, 17, 18, 19, 21, 22, 24, 27	14770
	1401A, 1402A
	1401B, 1402B

14245M-12P	18 Pieces Set/△=2,250g
METAL CASE:W310xH90xT48mm	
Sockets	Accessories
 14405M 12-pt. Sockets	 14760-125
10, 12, 13, 14, 16, 17, 18, 19, 21, 22, 24, 27	14770
	1401A, 1402A
	1401B, 1402B

S14240M	14400M 98 Pieces Set/△=13,690g	
DISPLAY STAND:W510xH150xT230mm		
 10mm:8pcs	15mm:7pcs	22mm:6pcs
11mm:8pcs	16mm:7pcs	23mm:6pcs
12mm:8pcs	17mm:7pcs	24mm:6pcs
13mm:8pcs	19mm:7pcs	27mm:5pcs
14mm:8pcs	21mm:7pcs	

14207M  Socket Set
Juego de Vasos



14208M  Socket Set
Juego de Vasos



14241M  Socket Set
Juego de Vasos

14241M-05 



14242M  Socket Set
Juego de Vasos



14245M-6P  Socket Set
Juego de Vasos

14245M-12P 



S14240M  Display Stand
Expositor



Z-SERIES
HAND
MANUALES
TITANIUM
DE TITANIO
ACCESSORIES
ACCESORIOS
SCREWDRIVERS
DESTORNILLADORES
IMPACT
DE IMPACTO
SLEEVE-DRIVE
INDUSTRIAL
INDUSTRIALES
PROTECTOR
PROTECTORES
AUTOMOTIVE
CONSTRUCTION
CONSTRUCCION
RENEWAL KITS
JUEGOS DE HERRAMIENTAS

Impact Sockets **5/8"**



Z-SERIES
HAND MANUALES
TITANIUM DE TITANIO
ACCESSORIES ACCESORIOS
SCREWDRIVERS DESTORNILLADORES
IMPACT DE IMPACTO
SLEEVE-DRIVE
INDUSTRIAL INDUSTRIALES
PROTECTOR PROTECTORES
AUTOMOTIVE
RENEWAL KITS CONSTRUCTION JUEGOS DE PIEZAS REPUËSTO CONSTRUCCI3N

15400M 6-point Sockets Vasos Hexagonales

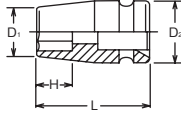

FLAT DRIVE®





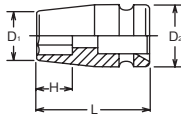

15400M (mm)	D ₁ (mm)	D ₂ (mm)	H (mm)	L (mm)	 (g)	 (pcs.)	
14	24	35	10	47.5	220	5	*1
17	27.8	35	12	47.5	225	5	*1
19	30.3	35	13	47.5	225	5	*1
21	32.8	35	15	47.5	225	5	*1
22	34	35	15	47.5	225	5	*1
23	35.4	35	16	47.5	225	5	*1
24	36.5	35	16	50.5	245	5	*1
26	39	35	16	50.5	260	1	*1

*1 Pin/O-Ring=1500A/B 

15400A 6-point Sockets Vasos Hexagonales



15400A (inch)	D ₁ (mm)	D ₂ (mm)	H (mm)	L (mm)	 (g)	 (pcs.)	
9/16	24	35	10	47.5	220	5	*1
5/8	26.5	35	11	47.5	225	5	*1
11/16	27.8	35	12	47.5	225	5	*1
3/4	30.3	35	13	47.5	225	5	*1
13/16	32.8	35	15	47.5	225	5	*1
7/8	34	35	15	47.5	225	5	*1
15/16	36.5	35	16	50.5	245	5	*1



*1 Pin/O-Ring=1500A/B 

15410M Surface Drive Sockets Vasos Surface Drive (de Contacto Curvo)

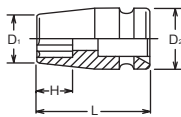

SURFACE DRIVE



15410M (mm)	D ₁ (mm)	D ₂ (mm)	H (mm)	L (mm)	 (g)	 (pcs.)	
14	24	35	10	47.5	220	5	*1
17	27.8	35	12	47.5	225	5	*1
19	30.3	35	13	47.5	225	5	*1
21	32.8	35	15	47.5	225	5	*1
22	34	35	15	47.5	225	5	*1
23	35.4	35	16	47.5	225	5	*1
24	36.5	35	16	50.5	245	5	*1
26	39	35	16	50.5	260	5	*1

*1 Pin/O-Ring=1500A/B 

SURFACE DRIVE

Surface drive sockets are designed to retain contact with flat sides of nut to transmit high torque and reduce nut wear. These sockets are ideal for use on polished nuts, aluminum nuts and nuts with worn out points.

Los vasos de contacto curvo se diseñan para mantener el contacto con las caras planas de la tuerca y transmitir un alto par reduciendo el desgaste de la tuerca. Estos vasos son ideales para utilizarse en tuercas pulidas, tuercas de aluminio y tuercas con puntas gastadas



15300M (mm)	D ₁ (mm)	D ₂ (mm)	H ₁ (mm)	H ₂ (mm)	L (mm)	(g)	(pcs.)	
14	24	35	14	71	90	295	2	*1
17	27.8	35	17	71	90	325	2	*1
19	30.3	35	19	71	90	350	2	*1
21	32.8	35	21	71	90	380	2	*1
22	34	35	22	71	90	390	2	*1

*1 Pin/O-Ring=1500A/B → P255



15300M 6-point Deep Sockets Vasos Hexagonales Largos

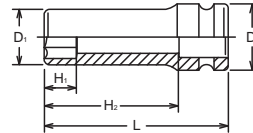

15310M (mm)	D ₁ (mm)	D ₂ (mm)	H ₁ (mm)	H ₂ (mm)	L (mm)	(g)	(pcs.)	
14	24	35	14	71	90	295	2	*1
17	27.8	35	17	71	90	325	2	*1
19	30.3	35	19	71	90	350	2	*1
21	32.8	35	21	71	90	380	2	*1
22	34	35	22	71	90	390	2	*1

*1 Pin/O-Ring=1500A/B → P255



15310M Surface Drive Sockets, Deep Vasos Surface Drive (de Contacto Curvo) Largos

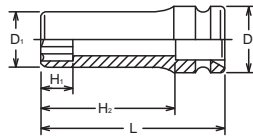

	L (mm)	(g)	(pce.)	
15555AL	70	310	1	*1

*1 Pin/O-Ring=1500A/B → P255

Lock & Quick Release

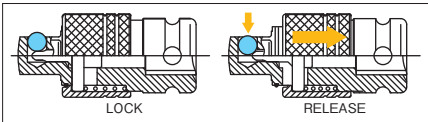

⚠ You may not hold the sliding part while moving to avoid heating up by friction and reduction by wear.

	L (mm)	(g)	(pce.)	
15770	88	420	1	*1

*1 Pin/O-Ring=1500A/B → P255

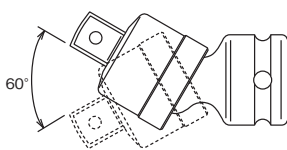

15555AL Adaptor (Quick Release) Adaptador (Extracción Rápida) ⚠



15770 Universal Joint Articulación Universal



	(sq.)	(sq.)	L (mm)	(g)	(pce.)	
15544A	5/8"	1/2"	46	165	1	*1
15544A-P	5/8"	1/2"	46	165	1	*1

*1 Pin/O-Ring=1500A/B → P255

⚠ Adapting down from bigger square drive to smaller square drive may lead to excessive torque load and possibly cause breakage. Always stay within safe torque of the smaller square drive.

15544A Adaptor Adaptador ⚠



15566A Adaptor Adaptador



	(sq.)	(sq.)	L (mm)	(g)	(pce.)	
15566A	5/8"	3/4"	48	200	1	*1

*1 Pin/O-Ring=1500A/B → P255

Z-SERIES
HAND
MANUALES
TITANIUM
DE TITANIO
ACCESSORIES
ACCESORIOS
SCREWDRIVERS
DESTORNILLADORES
IMPACT
DE IMPACTO
SLEEVE-DRIVE
INDUSTRIAL
INDUSTRIALES
PROTECTOR
PROTECTORES
AUTOMOTIVE
CONSTRUCTION
CONSTRUCCION
RENEWAL KITS
JUEGOS DE HERRAMIENTAS

Impact Sockets 3/4"

16400M • 16400A

6-point Sockets
Vasos Hexagonales

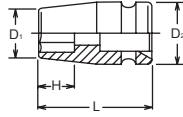

16400A (inch)	D ₁ (mm)	D ₂ (mm)	H (mm)	L (mm)	(g)	(pcs.)	
5/8	28.8	44	11	50	366	5	*1
11/16	30	44	12	50	355	5	*1
3/4	32.5	44	13	50	360	5	*1
13/16	35	44	15	50	374	5	*1
7/8	36.3	44	15	50	373	5	*1
15/16	38.8	44	16	50	370	5	*1
1	40	44	16	50	374	5	*1
1. 1/16	42.5	44	16	50	375	5	*1
1. 1/8	45	44	18	53	412	5	*1
1. 3/16	46.3	44	18	53	410	5	*1
1. 1/4	48.8	44	19	53	428	5	*1
1. 5/16	51.3	44	20	55	490	5	*1
1. 3/8	52.5	44	20	55	494	5	*1
1. 7/16	55	44	20	55	526	2	*1
1. 1/2	56.3	44	20	57	558	2	*1
1. 9/16	58.8	44	20	57	598	2	*1
1. 5/8	60	44	22	57	572	2	*1
1.11/16	62.5	44	23	62	720	2	*1
1. 3/4	65	44	23	62	757	2	*1
1.13/16	66.3	44	23	62	755	2	*1
1. 7/8	68.8	54	23	62	940	2	*2
1.15/16	70	54	23	62	912	2	*2
2	72.5	54	30	62	969	2	*2
2. 1/16	73.8	54	29	62	1011	2	*2
2. 1/8	76.3	54	29	62	1035	2	*2
2. 3/16	77.5	54	29	62	1056	2	*2
2. 1/4	80	54	32	65	1126	2	*2
2. 5/16	81.3	54	31	65	1163	2	*2
2. 3/8	83.8	54	31	65	1215	2	*2

16400M (mm)	D ₁ (mm)	D ₂ (mm)	H (mm)	L (mm)	(g)	(pcs.)	
16	28.8	44	11	50	367	5	*1
17	30	44	12	50	355	5	*1
18	31.3	44	13	50	372	5	*1
19	32.5	44	13	50	360	5	*1
20	33.8	44	14	50	375	5	*1
21	35	44	15	50	374	5	*1
22	36.3	44	15	50	373	5	*1
23	37.5	44	16	50	373	5	*1
24	38.8	44	16	50	370	5	*1
25	40	44	16	50	374	5	*1
26	41.3	44	16	50	378	5	*1
27	42.5	44	16	50	375	5	*1
28	43.8	44	16	50	383	5	*1
29	45	44	18	53	412	5	*1
30	46.3	44	18	53	410	5	*1
31	47.5	44	18	53	426	5	*1
32	48.8	44	19	53	428	5	*1
33	50	44	20	55	470	5	*1
34	51.3	44	20	55	490	5	*1
35	52.5	44	20	55	494	5	*1
36	53.8	44	20	55	498	5	*1
37	55	44	20	55	526	2	*1
38	56.3	44	20	57	558	2	*1
39	57.5	44	20	57	579	2	*1
40	58.8	44	20	57	598	2	*1
41	60	44	22	57	572	2	*1
42	61.3	44	22	57	617	2	*1
43	62.5	44	23	62	720	2	*1
44	63.8	44	23	62	761	2	*1
45	65	44	23	62	757	2	*1
46	66.3	44	23	62	755	2	*1
47	67.5	54	23	62	805	2	*2
48	68.8	54	23	62	940	2	*2
49	70	54	23	62	912	2	*2
50	71.3	54	30	62	930	2	*2
52	73.8	54	29	62	1011	2	*2
54	76.3	54	29	62	1035	2	*2
55	77.5	54	29	62	1056	2	*2
56	78.8	54	29	62	1091	2	*2
57	80	54	32	65	1126	2	*2
58	81.3	54	31	65	1163	2	*2
59	82.5	54	31	65	1185	2	*2
60	83.8	54	31	65	1215	2	*2
65	90	54	30	65	1325	2	*2
70	96.3	54	34	70	1570	1	*2

*1 C-Ring=1600C, Pin/O-Ring=1601A/B
 *2 C-Ring=1801C, Pin/O-Ring=1602A/B → P254-255

16405M • 16405A

12-point Sockets
Vasos Bihexagonales

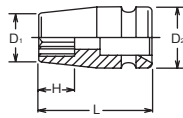

16405A (inch)	D ₁ (mm)	D ₂ (mm)	H (mm)	L (mm)	(g)	(pcs.)	
3/4	32.5	44	13	50	360	5	*1
13/16	35	44	15	50	374	5	*1
7/8	36.3	44	15	50	373	5	*1
15/16	38.8	44	16	50	370	5	*1
1	40	44	16	50	374	5	*1
1. 1/16	42.5	44	16	50	375	5	*1
1. 1/8	45	44	18	53	412	5	*1
1. 3/16	46.3	44	18	53	410	5	*1
1. 1/4	48.8	44	19	53	428	5	*1
1. 5/16	51.3	44	20	55	490	5	*1
1. 3/8	52.5	44	20	55	494	5	*1
1. 7/16	55	44	20	55	526	2	*1
1. 1/2	56.3	44	20	57	558	2	*1
1. 5/8	60	44	22	57	572	2	*1
1.11/16	62.5	44	23	62	720	2	*1
1. 3/4	65	44	23	62	757	2	*1
1. 7/8	68.8	54	23	62	940	2	*2
2	72.5	54	30	62	969	2	*2

16405M (mm)	D ₁ (mm)	D ₂ (mm)	H (mm)	L (mm)	(g)	(pcs.)	
17	30	44	12	50	355	5	*1
18	31.3	44	13	50	372	5	*1
19	32.5	44	13	50	360	5	*1
20	33.8	44	14	50	375	5	*1
21	35	44	15	50	374	5	*1
22	36.3	44	15	50	373	5	*1
23	37.5	44	16	50	373	5	*1
24	38.8	44	16	50	370	5	*1
25	40	44	16	50	374	5	*1
26	41.3	44	16	50	378	5	*1
27	42.5	44	16	50	375	5	*1
28	43.8	44	16	50	383	5	*1
29	45	44	18	53	412	5	*1
30	46.3	44	18	53	410	5	*1
32	48.8	44	19	53	428	5	*1
33	50	44	20	55	470	5	*1
34	51.3	44	20	55	490	5	*1
36	53.8	44	20	55	498	5	*1
38	56.3	44	20	57	558	2	*1
41	60	44	22	57	572	2	*1
42	61.3	44	22	57	617	2	*1
46	66.3	44	23	62	755	2	*1
50	71.3	54	30	62	930	2	*2
52	73.8	54	29	62	1011	2	*2
55	77.5	54	29	62	1056	2	*2
60	83.8	54	31	65	1215	2	*2
65	90	54	30	65	1325	2	*2

*1 C-Ring=1600C, Pin/O-Ring=1601A/B
 *2 C-Ring=1801C, Pin/O-Ring=1602A/B → P254-255

3/4" Impact Sockets



16401M • 16401A

6-point Sockets, Thin Walled
Vasos Hexagonales de Pared Delgada

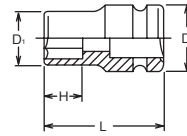

16401M (mm)	D ₁ (mm)	D ₂ (mm)	H (mm)	L (mm)	(g)	(pcs.)	⚡
17	28	43	12	50	300	5	*1
18	29.3	43	13	50	300	5	*1
19	30.5	43	13	50	300	5	*1
20	31.8	43	14	50	302	5	*1
21	33	43	15	50	305	5	*1
22	34.3	43	15	50	310	5	*1
23	35.5	43	16	50	315	5	*1
24	36.8	43	16	50	325	5	*1
25	38	43	16	50	326	5	*1
26	39.3	43	16	50	330	5	*1
27	40.5	43	16	50	340	5	*1
28	41.8	43	16	50	345	5	*1
29	43	43	18	53	355	5	*1
30	44.3	43	18	53	365	5	*1
31	45.5	43	18	53	375	5	*1
32	46.8	43	19	53	385	5	*1
33	48	43	20	55	395	5	*1
34	49.3	43	20	55	420	5	*1
35	50.5	43	20	55	430	5	*1
36	51.8	43	20	55	440	5	*1
37	53	43	20	55	460	2	*1
38	54.3	43	20	57	472	2	*1
40	56.8	43	20	57	525	2	*1
41	58	43	22	57	555	2	*1
42	59.3	43	22	57	565	2	*1
43	60.5	43	23	62	662	2	*1
44	61.8	43	23	62	670	2	*1
45	63	43	23	62	700	2	*1
46	64.3	43	23	62	710	2	*1

*1 C-Ring=1600C, Pin/O-Ring=1601A/B → P254-255

16401A (inch)	D ₁ (mm)	D ₂ (mm)	H (mm)	L (mm)	(g)	(pcs.)	⚡
11/16	28	43	12	50	300	5	*1
3/4	30.5	43	13	50	300	5	*1
13/16	33	43	15	50	305	5	*1
7/8	34.3	43	15	50	310	5	*1
15/16	36.8	43	16	50	325	5	*1
1	38	43	16	50	326	5	*1
1. 1/16	40.5	43	16	50	340	5	*1
1. 1/8	43	43	18	53	355	5	*1
1. 3/16	44.3	43	18	53	365	5	*1
1. 1/4	46.8	43	19	53	385	5	*1
1. 5/16	49.3	30	20	55	437	5	*1
1. 3/8	50.5	43	20	55	430	5	*1
1. 7/16	53	43	20	55	460	2	*1
1. 1/2	54.3	43	20	57	472	2	*1
1. 9/16	56.8	43	20	57	525	2	*1
1. 5/8	58	43	22	57	555	2	*1
1.13/16	64.3	43	23	62	710	2	*1
1. 7/8	66.8	53	23	62	868	2	*2

*1 C-Ring=1600C, Pin/O-Ring=1601A/B → P254-255

16410M (mm)	D ₁ (mm)	D ₂ (mm)	H (mm)	L (mm)	(g)	(pcs.)	⚡
16	28.8	44	11	50	367	5	*1
17	30	44	12	50	355	5	*1
18	31.3	44	13	50	372	5	*1
19	32.5	44	13	50	360	5	*1
21	35	44	15	50	374	5	*1
22	36.3	44	15	50	373	5	*1
24	38.8	44	16	50	370	5	*1
27	42.5	44	16	50	375	5	*1
30	46.3	44	18	53	410	5	*1
32	48.8	44	19	53	428	5	*1
33	50	44	20	55	470	5	*1
36	53.8	44	20	55	498	5	*1

*1 C-Ring=1600C, Pin/O-Ring=1601A/B → P254-255

16410M

Surface Drive Sockets
Vasos Surface Drive (de Contacto Curvo)



SURFACE DRIVE

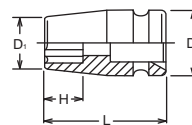

Z-SERIES
HAND
MANUALES
TITANIUM
DE TITANIO
ACCESSORIES
ACCESORIOS
SCREWDRIVERS
DESTORNILLADORES
IMPACT
DE IMPACTO
SLEEVE-DRIVE
INDUSTRIAL
INDUSTRIALES
PROTECTOR
PROTECTORES
AUTOMOTIVE
CONSTRUCTION
CONSTRUCCION
RENEWAL KITS
JUEGOS DE PIEZAS/REPUESTO

Impact Sockets **3/4"**

Z-SERIES
HAND MANUALES
TITANIUM DE TITANIO
ACCESSORIES ACCESORIOS
SCREWDRIVERS DESTORNILLADORES
IMPACT DE IMPACTO
SLEEVE-DRIVE
INDUSTRIAL INDUSTRIALES
PROTECTOR PROTECTORES
AUTOMOTIVE
CONSTRUCTION CONSTRUCCIÓN
RENEWAL KITS JUEGOS DE PIEZAS REPUESTO

16425 TORX® Sockets Vasos TORX®

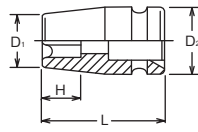

16425 (E)	D ₁ (mm)	D ₂ (mm)	H (mm)	L (mm)	(g)	(pcs.)	
E18	26.3	44	13	50	355	5	*1
E20	28.8	44	14.4	50	370	5	*1
E22	31.3	44	15.5	50	390	5	*1
E24	32.5	44	17	50	390	5	*1
E26	35	44	18.8	60	460	5	*1
E28	36.3	44	25.2	60	465	5	*1
E30	38.8	44	25.2	60	480	5	*1
E32	41.3	44	25.2	60	480	5	*1

*1 C-Ring=1600C, Pin/O-Ring=1601A/B → P254-255

TORX® (E)

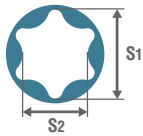

E	E4	E5	E6	E7	E8	E10	E11	E12	E14	E16	E18	E20	E22	E24	E26	E28	E30	E32
S ₁ (ref. mm)	3.7	4.6	5.6	6.1	7.4	9.3	9.9	11.0	12.8	14.6	16.5	18.3	20.1	22.0	23.7	25.5	27.3	29.0
S ₂ (ref. mm)	2.7	3.3	4.0	4.3	5.3	6.8	7.1	7.9	9.2	10.5	11.9	13.2	14.8	15.7	17.5	18.3	20.0	21.3

16425-EPL TORXPLUS® Sockets Vasos TORXPLUS®

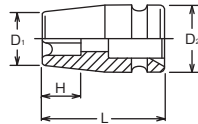

16425-EPL (EPL)	D ₁ (mm)	D ₂ (mm)	H (mm)	L (mm)	(g)	(pcs.)	
24EPL	32.5	44	12.2	55	427	5	*1
32EPL	40	44	16.1	62	488	2	*1

*1 C-Ring=1600C, Pin/O-Ring=1601A/B → P254-255

TORXplus® (EP/EPL)

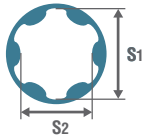

EP/EPL	8EP	10EP	12EP	14EP	16EP	18EP	20EP	22EP	24EP	26EP	28EP	30EP	32EP
S ₁ (ref. mm)	7.4	9.3	11.0	12.8	14.6	16.5	18.3	20.1	22.0	23.7	25.5	27.3	29.0
S ₂ (ref. mm)	5.3	6.8	7.9	9.2	10.5	11.9	13.2	14.8	15.7	17.5	18.3	20.0	21.3

16301X 6-point Semi-Deep Sockets, Thin Walled Vasos Hexagonales Medianos de Pared Delgada

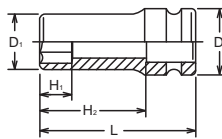

16301X (mm)	D ₁ (mm)	D ₂ (mm)	H ₁ (mm)	H ₂ (mm)	L (mm)	(g)	(pcs.)	
17	28	43	17	49	75	370	2	*1
18	29.3	43	18	49	75	380	2	*1
19	30.5	43	19	49	75	393	2	*1
20	31.8	43	20	49	75	400	2	*1
21	33	43	21	49	75	408	2	*1
22	34.3	43	22	49	75	418	2	*1
23	35.5	43	23	49	75	425	2	*1
24	36.8	43	24	49	75	435	2	*1
25	38	43	25	49	75	449	2	*1
26	39.3	43	26	49	75	455	2	*1
27	40.5	43	27	48	75	464	2	*1
28	41.8	43	28	48	75	479	2	*1
29	43	43	29	48	75	489	2	*1
30	44.3	43	30	48	75	506	2	*1
31	45.5	43	31	47	75	518	2	*1
32	46.8	43	32	47	75	535	2	*1
33	48	43	33	47	75	548	2	*1
35	50.5	43	35	46	75	585	2	*1
36	51.8	43	36	46	75	603	2	*1
37	53	43	37	46	75	645	2	*1
38	54.3	43	38	50	80	691	2	*1
40	56.8	43	38	50	80	725	2	*1
41	58	43	38	49	80	755	2	*1
46	64.3	43	38	48	80	808	2	*1

*1 C-Ring=1600C, Pin/O-Ring=1601A/B → P254-255

TORX is a registered trademark of Acument Intellectual Properties, LLC.
 TORX es una marca registrada de Acument Intellectual Properties, LLC.
 TORXplus is a registered trademark of Acument Intellectual Properties, LLC.
 TORXplus es una marca registrada de Acument Intellectual Properties, LLC.



16300M • 16300A 6-point Sockets, Deep Vasos Hexagonales Largos

16300M (mm)	D ₁ (mm)	D ₂ (mm)	H ₁ (mm)	H ₂ (mm)	L (mm)	(g)	(pcs.)	
14	26.3	44	14	74	100	497	2	*1
16	28.8	44	16	74	100	524	2	*1
17	30	44	17	74	100	544	2	*1
18	31.3	44	18	74	100	642	2	*1
19	32.5	44	19	74	100	655	2	*1
20	33.8	44	20	74	100	680	2	*1
21	35	44	21	74	100	700	2	*1
22	36.3	44	22	74	100	700	2	*1
23	37.5	44	23	74	100	720	2	*1
24	38.8	44	24	74	100	705	2	*1
25	40	44	25	74	100	715	2	*1
26	41.3	44	26	74	100	710	2	*1
27	42.5	44	27	73	100	710	2	*1
28	43.8	44	28	73	100	800	2	*1
29	45	44	29	73	100	835	2	*1
30	46.3	44	30	73	100	840	2	*1
31	47.5	44	31	72	100	815	2	*1
32	48.8	44	32	72	100	875	2	*1
33	50	44	33	72	100	920	2	*1
34	51.3	44	34	72	100	950	2	*1
35	52.5	44	35	71	100	980	2	*1
36	53.8	44	36	71	100	960	2	*1
37	55	44	37	71	100	970	2	*1
38	56.3	44	38	70	100	990	2	*1
39	57.5	44	38	70	100	1040	2	*1
40	58.8	44	38	70	100	1060	2	*1
41	60	44	38	69	100	1120	2	*1
42	61.3	44	38	69	100	1153	2	*1
43	62.5	44	38	69	100	1200	2	*1
46	66.3	44	38	68	100	1305	2	*1
48	68.8	54	38	68	100	1480	2	*2
50	71.3	54	61	-	100	1469	2	*2
55	77.5	54	59	-	100	1620	2	*2
60	83.8	54	56	-	100	1835	2	*2

*1 C-Ring=1600C, Pin/O-Ring=1601A/B → P254-255
*2 C-Ring=1801C, Pin/O-Ring=1602A/B

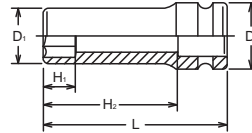

16300A (inch)	D ₁ (mm)	D ₂ (mm)	H ₁ (mm)	H ₂ (mm)	L (mm)	(g)	(pcs.)	
3/4	32.5	44	19	74	100	655	2	*1
13/16	35	44	21	74	100	700	2	*1
7/8	36.3	44	22	74	100	700	2	*1
15/16	38.8	44	24	74	100	705	2	*1
1	40	44	25	74	100	715	2	*1
1. 1/16	42.5	44	27	73	100	765	2	*1
1. 1/8	45	44	29	73	100	835	2	*1
1. 3/16	46.3	44	30	73	100	840	2	*1
1. 1/4	48.8	44	32	72	100	875	2	*1
1. 5/16	51.3	44	34	72	100	950	2	*1
1. 3/8	52.5	44	35	71	100	980	2	*1
1. 7/16	55	44	37	71	100	970	2	*1
1. 1/2	56.3	44	38	70	100	990	2	*1
1. 9/16	58.8	44	38	70	100	1060	2	*1
1. 5/8	60	44	38	69	100	1120	2	*1
1. 11/16	62.5	44	38	69	100	1200	2	*1
1. 3/4	65	44	38	68	100	1284	2	*1
1. 13/16	66.3	44	38	68	100	1305	2	*1
1. 7/8	68.8	54	38	67	100	1561	2	*2
2	72.5	54	60	-	100	1516	2	*2

*1 C-Ring=1600C, Pin/O-Ring=1601A/B → P254-255
*2 C-Ring=1801C, Pin/O-Ring=1602A/B

16301M • 16301A 6-point Deep Sockets, Thin Walled Vasos Hexagonales Largos de Pared Delgada



16301M (mm)	D ₁ (mm)	D ₂ (mm)	H ₁ (mm)	H ₂ (mm)	L (mm)	(g)	(pcs.)	
16	26.8	43	16	74	100	435	2	*1
17	28	43	17	74	100	470	2	*1
18	29.3	43	18	74	100	475	2	*1
19	30.5	43	19	74	100	480	2	*1
20	31.8	43	20	74	100	491	2	*1
21	33	43	21	74	100	505	2	*1
22	34.3	43	22	74	100	528	2	*1
23	35.5	43	23	74	100	542	2	*1
24	36.8	43	24	74	100	560	2	*1
25	38	43	25	74	100	581	2	*1
26	39.3	43	26	74	100	600	2	*1
27	40.5	43	27	73	100	610	2	*1
28	41.8	43	28	73	100	639	2	*1
29	43	43	29	73	100	650	2	*1
30	44.3	43	30	73	100	670	2	*1
31	45.5	43	31	72	100	690	2	*1
32	46.8	43	32	72	100	715	2	*1
33	48	43	33	72	100	730	2	*1
34	49.3	43	34	72	100	750	2	*1
35	50.5	43	35	71	100	785	2	*1
36	51.8	43	36	71	100	830	2	*1
37	53	43	37	71	100	850	2	*1
38	54.3	43	38	70	100	885	2	*1
39	55.5	43	38	70	100	908	2	*1
40	56.8	43	38	70	100	925	2	*1
41	58	43	38	69	100	970	2	*1
42	59.3	43	38	69	100	990	2	*1
46	64.3	43	38	68	100	1150	2	*1
50	69.2	53	62	-	100	1328	2	*2

*1 C-Ring=1600C, Pin/O-Ring=1601A/B → P254-255
*2 C-Ring=1801C, Pin/O-Ring=1602A/B

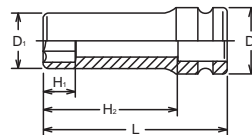

16301A (inch)	D ₁ (mm)	D ₂ (mm)	H ₁ (mm)	H ₂ (mm)	L (mm)	(g)	(pcs.)	
11/16	28	43	17	74	100	470	2	*1
3/4	30.5	43	19	74	100	480	2	*1
13/16	33	43	21	74	100	505	2	*1
7/8	34.3	43	22	74	100	528	2	*1
15/16	36.8	43	24	74	100	560	2	*1
1	38	43	25	74	100	581	2	*1
1. 1/16	40.5	43	27	73	100	610	2	*1
1. 1/8	43	43	29	73	100	650	2	*1
1. 3/16	44.3	43	30	73	100	670	2	*1
1. 1/4	46.8	43	32	72	100	715	2	*1
1. 5/16	49.3	43	34	72	100	790	2	*1
1. 3/8	50.5	43	35	71	100	785	2	*1
1. 7/16	53	43	37	71	100	850	2	*1
1. 1/2	54.3	43	38	70	100	885	2	*1
1. 9/16	56.8	43	38	70	100	925	2	*1
1. 5/8	58	43	38	69	100	970	2	*1
1. 13/16	64.3	43	38	68	100	1150	2	*1

*1 C-Ring=1600C, Pin/O-Ring=1601A/B → P254-255

Z-SERIES
HAND
MANUALES
TITANIUM
DE TITANIO
ACCESSORIES
ACCESORIOS
SCREWDRIVERS
DESTORNILLADORES
IMPACT
DE IMPACTO
SLEEVE-DRIVE
INDUSTRIAL
INDUSTRIALES
PROTECTOR
PROTECTORES
AUTOMOTIVE
CONSTRUCTION
CONSTRUCCION
RENEWAL KITS
JUEGOS DE HERRAMIENTAS

Impact Sockets **3/4"**

Z-SERIES
HAND MANUALES
TITANIUM DE TITANIO
ACCESSORIES ACCESORIOS
SCREWDRIVERS DESTORNILLADORES
IMPACT DE IMPACTO
SLEEVE-DRIVE
INDUSTRIAL INDUSTRIALES
PROTECTOR PROTECTORES
AUTOMOTIVE
CONSTRUCTION CONSTRUCCIÓN
RENEWAL KITS JUEGOS DE PIEZAS REPUESTO

16305M 12-point Sockets, Deep Vasos Bihexagonales Largos

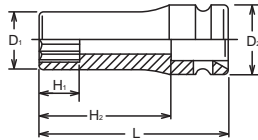

16305M (mm)	D ₁ (mm)	D ₂ (mm)	H ₁ (mm)	H ₂ (mm)	L (mm)	(g)	(pcs.)	
14	26.3	44	14	74	100	500	2	*1
16	28.8	44	16	74	100	522	2	*1
17	30	44	17	74	100	544	2	*1
18	31.3	44	18	74	100	600	2	*1
19	32.5	44	19	74	100	655	2	*1
21	35	44	21	74	100	700	2	*1
22	36.3	44	22	74	100	700	2	*1
23	37.5	44	23	74	100	720	2	*1
24	38.8	44	24	74	100	715	2	*1
26	41.3	44	26	74	100	760	2	*1
27	42.5	44	27	73	100	765	2	*1
28	43.8	44	28	73	100	800	2	*1
29	45	44	29	73	100	835	2	*1
30	46.3	44	30	73	100	840	2	*1
32	48.8	44	32	72	100	875	2	*1
33	50	44	33	72	100	920	2	*1
34	51.3	44	34	72	100	950	2	*1
35	52.5	44	35	71	100	980	2	*1
36	53.8	44	36	71	100	960	2	*1
38	56.3	44	38	70	100	990	2	*1
41	60	44	38	69	100	1120	2	*1
46	66.3	44	38	68	100	1305	2	*1
50	71.3	54	61	-	100	1469	2	*2

*1 C-Ring=1600C, Pin/O-Ring=1601A/B
*2 C-Ring=1801C, Pin/O-Ring=1602A/B → P254-255

16310M Surface Drive Sockets, deep Vasos Surface Drive (de Contacto Curvo) Largos

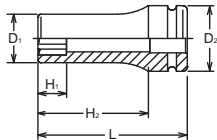

16310M (mm)	D ₁ (mm)	D ₂ (mm)	H ₁ (mm)	H ₂ (mm)	L (mm)	(g)	(pcs.)	
16	28.8	44	16	74	100	524	2	*1
17	30	44	17	74	100	544	2	*1
18	31.3	44	18	74	100	642	2	*1
19	32.5	44	19	74	100	655	2	*1
21	35	44	21	74	100	700	2	*1
22	36.3	44	22	74	100	700	2	*1
24	38.8	44	24	74	100	705	2	*1
27	42.5	44	27	73	100	710	2	*1
30	46.3	44	30	73	100	840	2	*1
32	48.8	44	32	72	100	875	2	*1
33	50	44	33	72	100	920	2	*1
36	53.8	44	34	71	100	960	2	*1

*1 C-Ring=1600C, Pin/O-Ring=1601A/B → P254-255

16325 TORX® Deep Sockets Vasos TORX® Largos

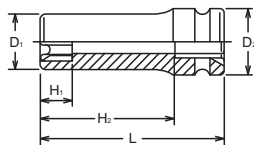

16325 (E)	D ₁ (mm)	D ₂ (mm)	H ₁ (mm)	H ₂ (mm)	L (mm)	(g)	(pcs.)	
E18	26.3	44	13	74	100	520	2	*1
E20	28.8	44	14.4	74	100	560	2	*1
E22	31.3	44	15.5	74	100	600	2	*1
E24	32.5	44	17	74	100	630	2	*1
E26	35	44	18.8	74	100	660	2	*1
E28	36.3	44	25.2	74	100	670	2	*1
E30	38.8	44	25.2	75	100	730	2	*1
E32	41.3	44	25.2	75	100	777	2	*1

*1 C-Ring=1600C, Pin/O-Ring=1601A/B → P254-255

TORX® (E)

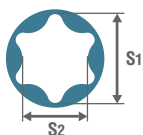

E	E4	E5	E6	E7	E8	E10	E11	E12	E14	E16	E18	E20	E22	E24	E26	E28	E30	E32
S ₁ (ref. mm)	3.7	4.6	5.6	6.1	7.4	9.3	9.9	11.0	12.8	14.6	16.5	18.3	20.1	22.0	23.7	25.5	27.3	29.0
S ₂ (ref. mm)	2.7	3.3	4.0	4.3	5.3	6.8	7.1	7.9	9.2	10.5	11.9	13.2	14.8	15.7	17.5	18.3	20.0	21.3

16106.16 (mm)	D (mm)	H (mm)	L (mm)	(g)	(pcs.)	
10	44	24	76	416	2	*1
12	44	24	76	422	2	*1
13	44	24	76	426	2	*1
14	44	24	76	430	2	*1
16	44	24	76	439	2	*1
17	44	24	76	443	2	*1
18	44	24	76	448	2	*1
19	44	24	76	450	2	*1
22	44	24	76	473	2	*1

16106.16 (inch)	D (mm)	H (mm)	L (mm)	(g)	(pcs.)	
1/2	44	24	76	426	2	*1
9/16	44	24	76	430	2	*1
5/8	44	24	76	439	2	*1
3/4	44	24	76	450	2	*1

*1 C-Ring=1600C, Pin/O-Ring=1601A/B → P254-255

16106.16 (T)	D (mm)	H (mm)	L (mm)	(g)	(pcs.)	
New T55	44	34	86	427	2	*1
New T60	44	34	86	434	2	*1
New T70	44	34	86	443	2	*1

*1 C-Ring=1600C, Pin/O-Ring=1601A/B → P254-255

16106.16 (XZN)	D (mm)	H (mm)	L (mm)	(g)	(pcs.)	
New M14	44	44	96	453	2	*1
New M16	44	44	96	463	2	*1
New M18	44	44	96	473	2	*1

*1 C-Ring=1600C, Pin/O-Ring=1601A/B → P254-255

16106	D ₁ (mm)	D ₂ (mm)	H (mm)	L (mm)	(g)	(pcs.)	
16106	32	44	16	52	370	2	*1

*1 C-Ring=1600C, Pin/O-Ring=1601A/B → P254-255

Replacement Screw : M6x10, 3mm

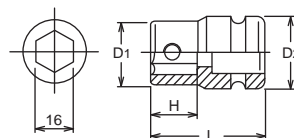

16106-16 Hex Bit Sockets Vasos con Punta Hexagonal

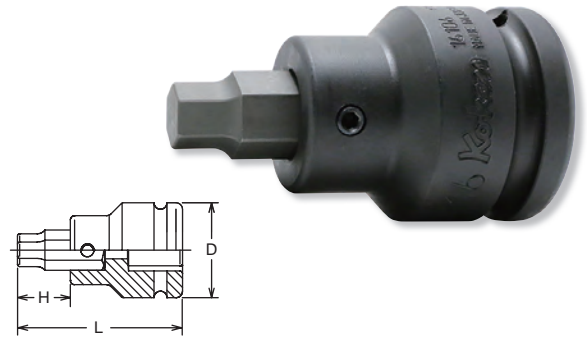

16106-16(T) TORX® Bit Sockets Vasos con Punta TORX®

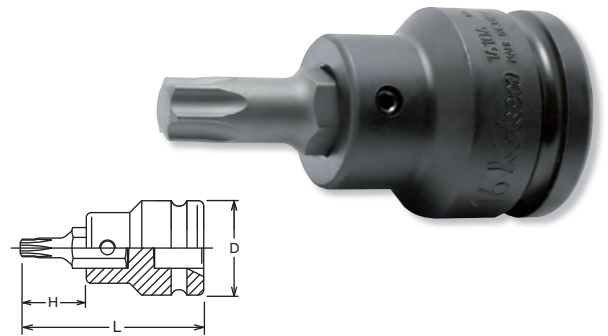

16106-16(XZN) XZN Bit Sockets Vasos con Punta XZN

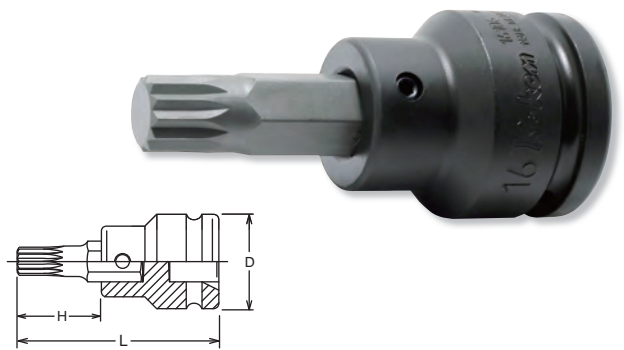

16106 Bit Holder, For 107-16 Porta Punta



Z-SERIES
HAND
MANUALES
TITANIUM
DE TITANIO
ACCESSORIES
ACCESORIOS
SCREWDRIVERS
DESTORNILLADORES
IMPACT
DE IMPACTO
SLEEVE-DRIVE
INDUSTRIAL
INDUSTRIALES
PROTECTOR
PROTECTORES
AUTOMOTIVE
CONSTRUCTION
CONSTRUCCION
RENEWAL KITS
JUEGOS DE HERRAMIENTAS

Impact Sockets **3/4"**

Z-SERIES
HAND MANUALES
TITANIUM DE TITANIO
ACCESSORIES ACCESORIOS
SCREWDRIVERS DESTORNILLADORES
IMPACT DE IMPACTO
SLEEVE-DRIVE
INDUSTRIAL INDUSTRIALES
PROTECTOR PROTECTORES
AUTOMOTIVE
CONSTRUCTION CONSTRUCCIÓN
RENEWAL KITS JUEGOS DE PIEZAS REPUÉSTO

107-16 Bits for Inhex Screws Puntas para Tornillos Inhex

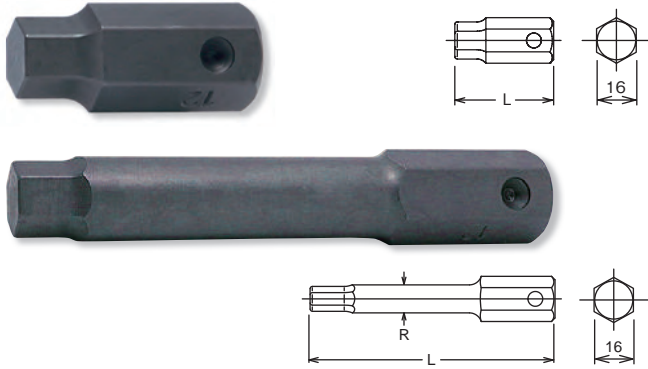

107.16 (mm)	L (mm)	(g)	(pcs.)
10	40	46	10
12	40	52	10
13	40	56	10
14	40	60	10
16	40	69	10
17	40	73	10
18	40	78	10
19	40	80	10
22	40	97	10

107.16 (inch)	L (mm)	(g)	(pcs.)
3/8	40	45	10
1/2	40	56	10
9/16	40	60	10
5/8	40	69	10
3/4	40	80	10

107.16(L100) (mm)	L (mm)	R (mm)	(g)	(pcs.)
10	100	13	122	10
12	100	15	146	10
14	100	-	166	10
17	100	-	193	10
19	100	-	232	10
22	100	-	254	10

107-16 (T) TORX® Bits Puntas TORX®

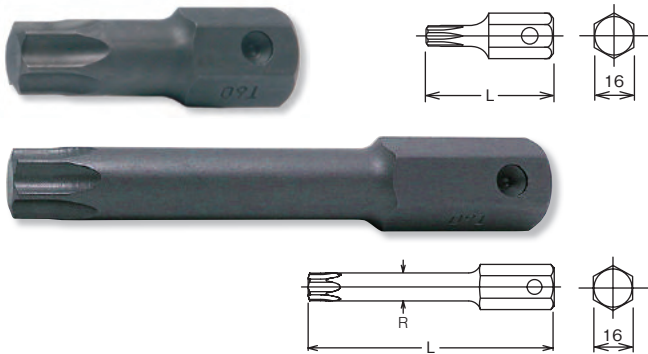

107.16 (T)	L (mm)	(g)	(pcs.)
T55	50	57	10
T60	50	64	10
T70	50	73	10

107.16(L100) (T)	L (mm)	R (mm)	(g)	(pcs.)
T55	100	11.4	108	10
T60	100	13.4	130	10
T70	100	15.7	159	10

107-16 (IP) TORXPLUS® Bits Puntas TORXPLUS®



107.16 (IP)	L (mm)	(g)	(pcs.)
55IP	50	57	10
60IP	50	64	10
70IP	50	73	10

107-16 (XZN) XZN Bits Puntas XZN

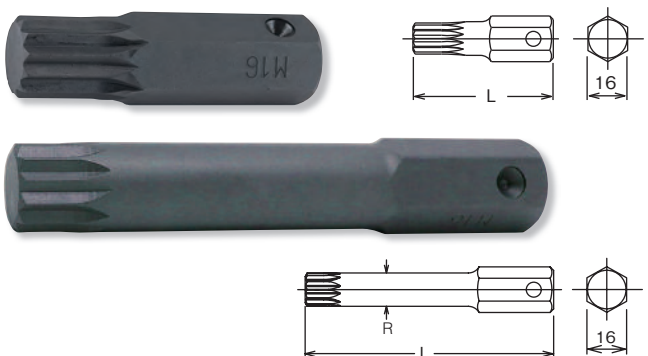

107.16 (XZN)	L (mm)	(g)	(pcs.)
M14	60	83	10
M16	60	93	10
M18	60	103	10

107.16(L100) (XZN)	L (mm)	R (mm)	(g)	(pcs.)
M14	100	13.4	131	10
M16	100	15.8	161	10
M18	100	17.1	177	10

TORX is a registered trademark of Acument Intellectual Properties, LLC.
TORX es una marca registrada de Acument Intellectual Properties, LLC.

TORXplus is a registered trademark of Acument Intellectual Properties, LLC.
TORXplus es una marca registrada de Acument Intellectual Properties, LLC.

16107.22 (mm)	D (mm)	H (mm)	L (mm)	(g)	(pcs.)	
19	44	28	88	670	2	*1
22	44	28	88	692	2	*1
24	44	28	88	706	2	*1
27	44	28	88	730	2	*1
30	44	28	88	757	2	*1
32	44	28	93	783	2	*1

*1 C-Ring=1600C, Pin/O-Ring=1601A/B → P254-255



16107	D ₁ (mm)	D ₂ (mm)	H (mm)	L (mm)	(g)	(pcs.)	
16107	44	44	22	60	530	2	*1

*1 C-Ring=1600C, Pin/O-Ring=1601A/B → P254-255

Replacement Screw : M8x14, ●4mm

16107-22 Hex Bit Sockets Vasos con Punta Hexagonal

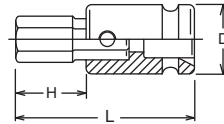

16107 Bit Holder Porta Punta

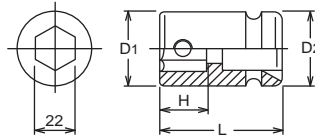
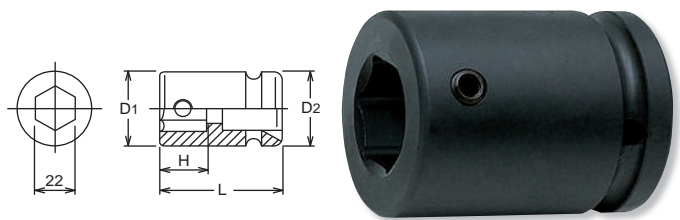

107-22 Bits for Inhex Screws Puntas para Tornillos Inhex

107.22 (mm)	L (mm)	(g)	(pcs.)
17	50	120	10
19	50	140	10
22	50	162	10
24	50	176	10
27	50	200	10
30	50	227	10
32	55	243	10

107.22 (inch)	L (mm)	(g)	(pcs.)
5/8	50	120	10
3/4	50	140	10
7/8	50	162	10
1	50	190	10
1. 1/4	55	243	10

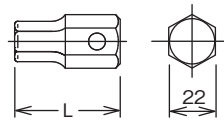

107-22 (T) TORX® Bits Puntas TORX®

107.22 (T)	L (mm)	(g)	(pcs.)
New T 70	60	129	10
T 80	60	141	10
T 90	60	155	10
T100	60	170	10

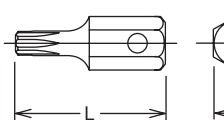
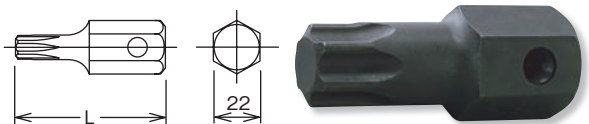

16760 Extension Bars Alargaderas



16760	D (mm)	L (mm)	(g)	(pce.)	
150	44	150	775	1	*1
175	44	175	870	1	*1
200	44	200	955	1	*1
250	44	250	1150	1	*1
330	44	330	1460	1	*1

*1 C-Ring=1600C, Pin/O-Ring=1601A/B → P254-255

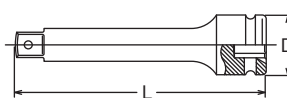

Z-SERIES
HAND
MANUALES
TITANIUM
DE TITANIO
ACCESSORIES
ACCESORIOS
SCREWDRIVERS
DESTORNILLADORES
IMPACT
DE IMPACTO
SLEEVE-DRIVE
INDUSTRIAL
INDUSTRIALES
PROTECTOR
PROTECTORES
AUTOMOTIVE
CONSTRUCTION
CONSTRUCCION
RENEWAL KITS
JUEGOS DE PIEZAS REPUESTO

Impact Sockets 3/4"

Z-SERIES
HAND MANUALES
TITANIUM DE TITANIO
ACCESSORIES ACCESORIOS
SCREWDRIVERS DESTORNILLADORES
IMPACT DE IMPACTO
SLEEVE-DRIVE
INDUSTRIAL INDUSTRIALES
PROTECTOR PROTECTORES
AUTOMOTIVE
CONSTRUCTION CONSTRUCCION
RENEWAL KITS JUEGOS DE PIEZAS REPUESTO

16666AL Adaptor (Quick Release)
Adaptador (Extracción Rápida) ⚠

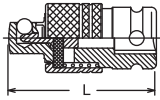

	L (mm)	(g)	(pcs.)	
16666AL	75	660	2	*1

*1 C-Ring=1600C, Pin/O-Ring=1601A/B → P254-255

Lock & Quick Release

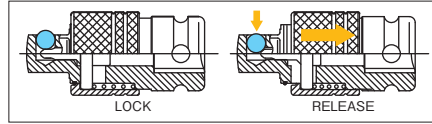

⚠ You may not hold the sliding part while moving to avoid heating up by friction and reduction by wear.

16770 Universal Joint
Articulación Universal

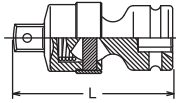

	L (mm)	(g)	(pce.)	
16770	106	790	1	*1
16771	95	720	1	*1

*1 C-Ring=1600C, Pin/O-Ring=1601A/B → P254-255

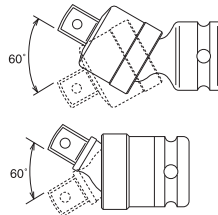

16771 Universal Joint
Articulación Universal

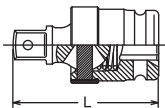

16644A · 16655A Adaptors
Adaptadores No Warranty Sin Garantía ⚠

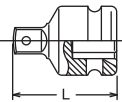

	□ (sq.)	□ (sq.)	L (mm)	(g)	(pcs.)	
16644A	3/4"	1/2"	54	310	5	*1
16644A-B	3/4"	1/2"	54	310	5	*1
16644A-P	3/4"	1/2"	54	310	5	*1

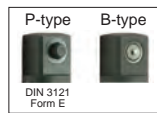

	□ (sq.)	□ (sq.)	L (mm)	(g)	(pcs.)	
16655A	3/4"	5/8"	55.5	336	5	*1

*1 C-Ring=1600C, Pin/O-Ring=1601A/B → P254-255

⚠ Adapting down to a smaller square drive may lead to excessive torque load and possibly cause breakage. Always stay within limit torque of the smaller square drive.

16688A Adaptor
Adaptador

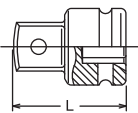

	□ (sq.)	□ (sq.)	L (mm)	(g)	(pce.)	
16688A	3/4"	1"	62	435	1	*1
16688A-250	3/4"	1"	250	1400	1	*1
16688A-330	3/4"	1"	330	1880	1	*1

*1 C-Ring=1600C, Pin/O-Ring=1601A/B → P254-255

16688A-250 · -330 Adaptors
Adaptadores



16201M • 16201A Socket Sets Juegos de Vasos





16201M	13 Pieces Set/△=6,800g
METAL CASE:W320xH110xT70mm	
Sockets	
 16400M 6-pt. Sockets	19, 21, 22, 23, 24, 26, 27, 30, 32, 33, 36, 38, 41

16201A	11 Pieces Set/△=6,000g
METAL CASE:W290xH120xT70mm	
Sockets	
 16400A 6-pt. Sockets	3/4, 7/8, 15/16, 1, 1.1/16, 1.1/8, 1.1/4, 1.5/16, 1.3/8, 1.7/16, 1.1/2

16201M-01 • 16201A-01 Sockets Sets Juegos de Vasos





16201M-01	13 Pieces Set/△=6,000g
METAL CASE:W320xH110xT70mm	
Sockets	
 16401M 6-pt. Sockets, Thin-walled	19, 21, 22, 23, 24, 26, 27, 30, 32, 33, 36, 38, 41

16201A-01	11 Pieces Set/△=5,400g
METAL CASE:W290xH120xT70mm	
Sockets	
 16401A 6-pt. Sockets, Thin-walled	3/4, 7/8, 15/16, 1, 1.1/16, 1.1/8, 1.1/4, 1.5/16, 1.3/8, 1.7/16, 1.1/2

16245M Socket Sets Juegos de Vasos

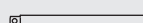

16245M	17 Pieces Set/△=12,000g
METAL CASE:W590xH227xT72mm	
Sockets	
 16400M 6-pt. Sockets	19, 21, 22, 24, 27, 29, 30, 32, 33, 35, 36, 38, 41, 46, 50
Accessories	
	16760-175
	16760-330

Z-SERIES
HAND
MANUALES
TITANIUM
DE TITANIO
ACCESSORIES
ACCESORIOS
SCREWDRIVERS
DESTORNILLADORES
IMPACT
DE IMPACTO
SLEEVE-DRIVE
INDUSTRIAL
INDUSTRIALES
PROTECTOR
PROTECTORES
AUTOMOTIVE
CONSTRUCTION
CONSTRUCCION
RENEWAL KITS
JUEGOS DE HEADS/REPUESTO

18400M • 18400A

6-point Sockets
Vasos Hexagonales

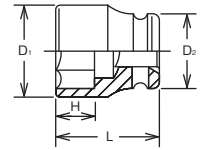



18400M (mm)	D ₁ (mm)	D ₂ (mm)	H (mm)	L (mm)	(g)	(pcs.)	⚡
17	32.8	54	12	57	579	2	*1
18	34	54	13	57	586	2	*1
19	35.3	54	13	57	590	2	*1
20	36.5	54	14	57	600	2	*1
21	37.8	54	15	57	605	2	*1
22	39	54	15	57	620	2	*1
23	40.3	54	16	57	615	2	*1
24	41.5	54	16	57	627	2	*1
25	42.8	54	16	57	620	2	*1
26	44	54	16	57	640	2	*1
27	45.3	54	16	57	627	2	*1
28	46.5	54	16	57	640	2	*1
29	47.8	54	18	57	657	2	*1
30	49	54	21	62	657	2	*1
31	50.3	54	21	62	687	2	*1
32	51.5	54	21	62	685	2	*1
33	52.8	54	21	62	685	2	*1
34	54	54	21	62	690	2	*1
35	55.3	54	21	62	710	2	*1
36	56.5	54	21	62	712	2	*1
37	57.8	54	21	62	735	2	*1
38	59	54	25	66	720	2	*1
39	60.3	54	25	66	820	2	*1
40	61.5	54	25	66	850	2	*1
41	62.8	54	25	66	850	2	*1
42	64	54	25	66	905	2	*1
43	65.3	54	27	68	977	2	*1
44	66.5	54	27	68	970	2	*1
45	67.8	54	27	68	963	2	*1
46	69	54	29	70	1010	2	*1
47	70.3	54	36	70	997	2	*1
48	71.5	54	35	70	990	2	*1
49	72.8	54	36	70	1020	2	*1
50	74	54	35	70	1065	2	*1
51	75.3	54	36	70	1100	2	*1
52	76.5	54	40	75	1185	2	*1
54	79	54	40	75	1252	2	*1
55	80.3	54	39	75	1260	2	*1
56	81.5	54	39	75	1277	2	*1
57	82.8	54	40	75	1300	2	*1
58	84	54	39	75	1340	2	*1
60	86.5	54	39	75	1400	2	*1
62	89	54	38	75	1410	2	*1
63	90.3	54	38	75	1383	2	*1
64	91.5	54	37	75	1580	2	*1
65	92.8	54	38	75	1630	2	*1
66	94	54	36	75	1580	2	*1
67	95.3	54	38	75	1580	2	*1
68	96.5	54	37	75	1583	1	*1
70	99	54	37	75	1625	1	*1
74	104	86	38	80	2650	1	*2
75	105.3	86	37	80	2675	1	*2
77	107.8	86	37	80	2890	1	*2
78	109	86	42	85	2900	1	*2
80	111.5	86	41	85	2996	1	*2
85	117.8	86	37	90	3378	1	*2
90	124	86	40	95	3871	1	*2
95	130.3	86	43	100	4500	1	*2
100	136.5	86	47	105	5000	1	*2

*1 C-Ring=1801C, Pin/O-Ring=1801A/B
*2 C-Ring=1802C, Pin/O-Ring=1802A/B → P254-255

18400A (inch)	D ₁ (mm)	D ₂ (mm)	H (mm)	L (mm)	(g)	(pcs.)	⚡
11/16	32.8	54	12	57	579	2	*1
3/4	35.3	54	13	57	590	2	*1
13/16	37.8	54	15	57	605	2	*1
7/8	39	54	15	57	620	2	*1
15/16	41.5	54	16	57	627	2	*1
1	42.8	54	16	57	620	2	*1
1. 1/16	45.3	54	16	57	627	2	*1
1. 3/32	46.5	54	16	57	642	2	*1
1. 1/8	47.8	54	18	57	657	2	*1
1. 3/16	49	54	21	62	657	2	*1
1. 1/4	51.5	54	21	62	685	2	*1
1. 9/32	52.8	54	21	62	692	2	*1
1. 5/16	54	54	21	62	690	2	*1
1. 3/8	55.3	54	21	62	710	2	*1
1. 7/16	57.8	54	21	62	735	2	*1
1.15/32	57.8	54	21	62	730	2	*1
1. 1/2	59	54	25	66	720	2	*1
1. 9/16	61.5	54	25	66	850	2	*1
1. 5/8	62.8	54	25	66	850	2	*1
1.11/16	65.3	54	27	68	977	2	*1
1. 3/4	67.8	54	27	68	963	2	*1
1.13/16	69	54	29	70	1010	2	*1
1. 7/8	71.5	54	35	70	990	2	*1
1.15/16	72.8	54	35	70	1000	2	*1
2	75.3	54	35	70	1060	2	*1
2. 1/16	76.5	54	40	75	1185	2	*1
2. 1/8	79	54	40	75	1252	2	*1
2. 3/16	80.3	54	39	75	1260	2	*1
2. 1/4	82.8	54	39	75	1337	2	*1
2. 5/16	84	54	39	75	1340	2	*1
2. 3/8	86.5	54	39	75	1400	2	*1
2. 7/16	89	54	38	75	1410	2	*1
2. 1/2	91.5	54	38	75	1498	2	*1
2. 9/16	92.8	54	38	75	1630	2	*1
2. 5/8	95.3	54	38	75	1580	2	*1
2.11/16	96.5	54	37	75	1583	1	*1
2. 3/4	99	54	37	75	1625	1	*1
2.13/16	101.5	86	37	80	2705	1	*2
2. 7/8	102.8	86	38	80	2629	1	*2
2.15/16	105.3	86	37	80	2675	1	*2
3	106.5	86	37	80	2705	1	*2
3. 1/16	109	86	42	85	2967	1	*2
3. 1/8	111.5	86	41	85	2996	1	*2
3. 1/4	115.3	86	44	90	3328	1	*2
3. 3/8	119	86	36	90	3389	1	*2
3. 1/2	124	86	40	95	3871	1	*2
3. 3/4	130.3	86	43	100	4377	1	*2
3. 7/8	135.3	86	47	105	5000	1	*2
4	137.8	86	46	105	5152	1	*2



*1 C-Ring=1801C, Pin/O-Ring=1801A/B
*2 C-Ring=1802C, Pin/O-Ring=1802A/B → P254-255

18405M • 18405A 12-point Sockets Vasos Bihexagonales

18405M (mm)	D ₁ (mm)	D ₂ (mm)	H (mm)	L (mm)	 (g)	 (pcs.)	
24	41.5	54	16	57	627	2	*1
27	45.3	54	16	57	607	2	*1
30	49	54	21	62	657	2	*1
32	51.5	54	21	62	685	2	*1
33	52.8	54	21	62	690	2	*1
35	55.3	54	21	62	690	2	*1
36	56.5	54	21	62	692	2	*1
38	59	54	25	66	700	2	*1
40	61.5	54	25	66	830	2	*1
41	62.8	54	25	66	905	2	*1
46	69	54	29	70	990	2	*1
50	74	54	35	70	1021	2	*1
55	80.3	54	39	75	1234	2	*1
56	81.5	54	39	75	1250	2	*1
60	86.5	54	39	75	1400	2	*1
65	92.8	54	38	75	1600	2	*1
70	99	54	37	75	1625	1	*1
75	105.3	86	37	80	2675	1	*2
80	111.5	86	41	85	2996	1	*2

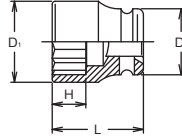
*1 C-Ring=1801C, Pin/O-Ring=1801A/B 





18405A (inch)	D ₁ (mm)	D ₂ (mm)	H (mm)	L (mm)	 (g)	 (pcs.)	
3/4	35.3	54	13	57	590	2	*1
7/8	39	54	15	57	620	2	*1
1	42.8	54	16	57	620	2	*1
1. 1/8	47.8	54	18	57	660	2	*1
1. 3/16	49	54	21	62	660	2	*1
1. 1/4	51.5	54	21	62	690	2	*1
1. 3/8	55.3	54	21	62	710	2	*1
1. 7/16	57.8	54	21	62	735	2	*1
1. 1/2	59	54	25	66	720	2	*1
1. 3/4	67.8	54	27	68	970	2	*1
1.15/16	72.8	54	35	70	1000	2	*1

*1 C-Ring=1801C, Pin/O-Ring=1801A/B 





18401M • 18401A 6-point Sockets, Thin Walled Vasos Hexagonales de Pared Delgada

18401M (mm)	D ₁ (mm)	D ₂ (mm)	H (mm)	L (mm)	 (g)	 (pcs.)	
17	29.8	53	12	57	481	2	*1
18	31	53	13	57	488	2	*1
19	32.3	53	13	57	492	2	*1
20	33.5	53	14	57	505	2	*1
21	34.8	53	15	57	512	2	*1
22	36	53	15	57	520	2	*1
24	38.5	53	16	57	520	2	*1
26	41	53	16	57	533	2	*1
27	42.3	53	16	57	540	2	*1
29	44.8	53	18	57	560	2	*1
30	46	53	21	62	572	2	*1
32	48.5	53	21	62	600	2	*1
33	49.8	53	21	62	613	2	*1
35	52.3	53	21	62	630	2	*1
36	53.5	53	21	62	635	2	*1
38	56	53	25	66	705	2	*1
40	58.5	53	25	66	725	2	*1
41	59.8	53	25	66	740	2	*1
42	61	53	25	66	803	2	*1
43	62.3	53	27	68	835	2	*1
45	64.8	53	27	68	888	2	*1
46	66	53	29	70	900	2	*1
47	67.3	53	36	70	915	2	*1
50	71	53	35	70	940	2	*1

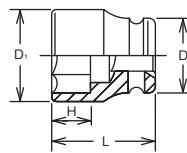
*1 C-Ring=1801C, Pin/O-Ring=1801A/B 



18401A (inch)	D ₁ (mm)	D ₂ (mm)	H (mm)	L (mm)	 (g)	 (pcs.)	
11/16	29.8	53	12	57	481	2	*1
3/4	32.3	53	13	57	492	2	*1
13/16	34.8	53	15	57	512	2	*1
7/8	36	53	15	57	520	2	*1
15/16	38.5	53	16	57	520	2	*1
1. 1/16	42.3	53	16	57	540	2	*1
1. 3/16	46	53	21	62	572	2	*1
1. 1/4	48.5	53	21	62	600	2	*1
1. 3/8	52.3	53	21	62	630	2	*1
1. 1/2	56	53	25	66	705	2	*1
1. 5/8	59.8	53	25	66	740	2	*1
1.13/16	66	53	29	70	900	2	*1

*1 C-Ring=1801C, Pin/O-Ring=1801A/B 

Z-SERIES
HAND
MANUALES
TITANIUM
DE TITANIO
ACCESSORIES
ACCESORIOS
SCREWDRIVERS
DESTORNILLADORES
IMPACT
DE IMPACTO
SLEEVE-DRIVE
INDUSTRIAL
INDUSTRIALES
PROTECTOR
PROTECTORES
AUTOMOTIVE
CONSTRUCTION
CONSTRUCCION
RENEWAL KITS
JUEGOS DE HERRAMIENTAS

Z-SERIES
HAND MANUALES
TITANIUM DE TITANIO
ACCESSORIES ACCESORIOS
SCREWDRIVERS DESTORNILLADORES
IMPACT DE IMPACTO
SLEEVE-DRIVE
INDUSTRIAL INDUSTRIALES
PROTECTOR PROTECTORES
AUTOMOTIVE
RENEWAL KITS CONSTRUCTION JUEGOS DE PIEZAS REPUES TO CONSTRUCCIÓN

18410M Surface Drive Sockets Vasos Surface Drive (de Contacto Curvo)



SURFACE DRIVE

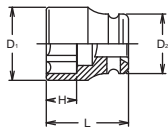

18410M (mm)	D ₁ (mm)	D ₂ (mm)	H (mm)	L (mm)	(g)	(pcs.)	
24	41.5	54	16	57	627	2	*1
27	45.3	54	16	57	627	2	*1
30	49	54	21	62	657	2	*1
32	51.5	54	21	62	685	2	*1
33	52.8	54	21	62	685	2	*1
36	56.5	54	21	62	712	2	*1
41	62.8	54	25	66	850	2	*1

*1 C-Ring=1801C, Pin/O-Ring=1801A/B → P254-255

18104M Extra Long Sockets Vasos Extra-Largos

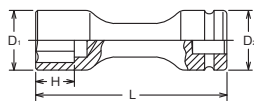

18104M (mm)	D ₁ (mm)	D ₂ (mm)	H (mm)	L (mm)	(g)	(pcs.)	
24	41.5	54	24	170	1327	1	*1
27	45.3	54	27	170	1375	1	*1
28	46.5	54	28	170	1390	1	*1
30	49	54	30	170	1407	1	*1
32	51.5	54	32	170	1537	1	*1
33	52.8	54	33	170	1590	1	*1
34	54	54	34	170	1670	1	*1
36	56.5	54	36	170	1800	1	*1

*1 C-Ring=1801C, Pin/O-Ring=1801A/B → P254-255



18301X (mm)	D ₁ (mm)	D ₂ (mm)	H ₁ (mm)	H ₂ (mm)	L (mm)	(g)	(pcs.)	
17	29.8	53	17	48	80	635	2	*1
19	32.3	53	19	48	80	655	2	*1
21	34.8	53	21	48	80	680	2	*1
22	36	53	22	48	80	686	2	*1
24	38.5	53	24	48	80	693	2	*1
27	42.3	53	27	48	80	745	2	*1
30	46	53	30	48	80	761	2	*1
32	48.5	53	32	53	85	770	2	*1
33	49.8	53	33	53	85	781	2	*1
35	52.3	53	35	53	85	800	2	*1
36	53.5	53	36	52	85	808	2	*1
38	56	53	38	52	85	865	2	*1
41	59.8	53	38	51	85	937	2	*1
46	66	53	38	50	85	1032	2	*1
50	71	53	55	-	85	1220	2	*1

*1 C-Ring=1801C, Pin/O-Ring=1801A/B → P254-255



18301X

6-point Semi-Deep Sockets, Thin Walled
Vasos Hexagonales Medianos de Pared Delgada



FLAT DRIVE®

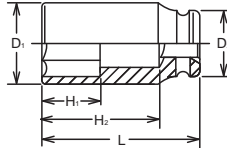

18300M • 18300A

6-point Sockets, Deep
Vasos Hexagonales Largos

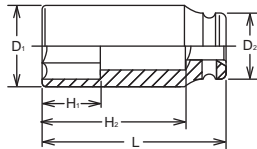

18300M (mm)	D ₁ (mm)	D ₂ (mm)	H ₁ (mm)	H ₂ (mm)	L (mm)	(g)	(pcs.)	
17	32.8	54	17	77	108	1000	2	*1
19	35.3	54	19	77	108	1010	2	*1
21	37.8	54	21	77	108	1010	2	*1
22	39	54	22	77	108	1010	2	*1
23	40.3	54	26	77	108	1063	2	*1
24	41.5	54	24	77	108	1060	2	*1
25	42.8	54	25	77	108	1085	2	*1
26	44	54	26	77	108	1133	2	*1
27	45.3	54	27	77	108	1125	2	*1
28	46.5	54	28	77	108	1140	2	*1
29	47.8	54	29	77	108	1120	2	*1
30	49	54	30	77	108	1179	2	*1
31	50.3	54	31	77	108	1125	2	*1
32	51.5	54	32	77	108	1200	2	*1
33	52.8	54	33	77	108	1200	2	*1
34	54	54	34	77	108	1280	2	*1
35	55.3	54	35	77	108	1300	2	*1
36	56.5	54	36	76	108	1280	2	*1
37	57.8	54	37	76	108	1320	2	*1
38	59	54	38	76	108	1423	2	*1
40	61.5	54	38	75	108	1415	2	*1
41	62.8	54	38	75	108	1450	2	*1
42	64	54	38	75	108	1550	2	*1
44	66.5	54	38	74	108	1636	2	*1
45	67.8	54	38	74	108	1660	2	*1
46	69	54	38	74	108	1680	2	*1
48	71.5	54	67	-	108	1500	2	*1
50	74	54	66	-	108	1650	2	*1
52	76.5	54	65	-	108	1770	2	*1
55	80.3	54	63	-	108	1855	2	*1
60	86.5	54	60	-	108	2047	2	*1
65	92.8	54	58	-	108	2310	2	*1
70	99	54	55	-	108	2440	1	*1
75	105.3	86	52	-	108	3646	1	*2
80	111.5	86	49	-	108	4039	1	*2
85	117.8	86	59	-	108	4000	1	*2
90	124	86	57	-	108	4200	1	*2
95	130.3	86	55	-	108	4400	1	*2

*1 C-Ring=1801C, Pin/O-Ring=1801A/B

*2 C-Ring=1802C, Pin/O-Ring=1802A/B

→ P254-255

18300A (inch)	D ₁ (mm)	D ₂ (mm)	H ₁ (mm)	H ₂ (mm)	L (mm)	(g)	(pcs.)	
11/16	32.8	54	17	77	108	978	2	*1
3/4	35.3	54	19	77	108	1010	2	*1
7/8	39	54	22	77	108	1010	2	*1
15/16	41.5	54	24	77	108	1060	2	*1
1	42.8	54	25	77	108	1085	2	*1
1. 1/16	45.3	54	27	77	108	1125	2	*1
1. 1/8	47.8	54	29	77	108	1120	2	*1
1. 3/16	49	54	30	77	108	1179	2	*1
1. 1/4	51.5	54	32	77	108	1200	2	*1
1. 5/16	54	54	34	77	108	1280	2	*1
1. 3/8	55.3	54	35	77	108	1300	2	*1
1. 7/16	57.8	54	37	76	108	1320	2	*1
1. 1/2	59	54	38	76	108	1423	2	*1
1. 9/16	61.5	54	38	75	108	1415	2	*1
1. 5/8	62.8	54	38	75	108	1450	2	*1
1.11/16	65.3	54	38	74	108	1577	2	*1
1. 3/4	67.8	54	38	74	108	1660	2	*1
1.13/16	69	54	38	74	108	1680	2	*1
1. 7/8	71.5	54	67	-	108	1500	2	*1
1.15/16	72.8	54	67	-	108	1570	2	*1
2	75.3	54	66	-	108	1605	2	*1
2. 1/16	76.5	54	65	-	108	1770	2	*1
2. 1/8	79	54	64	-	108	1812	2	*1
2. 3/16	80.3	54	63	-	108	1855	2	*1
2. 1/4	82.8	54	62	-	108	1916	2	*1
2. 5/16	84	54	61	-	108	1987	2	*1
2. 3/8	86.5	54	60	-	108	2047	2	*1
2. 7/16	89	54	59	-	108	2041	2	*1
2. 1/2	91.5	54	58	-	108	2250	2	*1
2. 9/16	92.8	54	58	-	108	2310	2	*1
2. 5/8	95.3	54	56	-	108	2370	1	*1
2. 3/4	99	54	55	-	108	2440	1	*1
2. 7/8	102.8	86	53	-	108	3600	1	*2
2.15/16	105.3	86	52	-	108	3646	1	*2
3	106.5	86	51	-	108	3677	1	*2
3. 1/16	109	86	50	-	108	3939	1	*2
3. 1/8	111.5	86	49	-	108	4039	1	*2
3. 3/16	112.8	86	48	-	108	4170	1	*2

*1 C-Ring=1801C, Pin/O-Ring=1801A/B

*2 C-Ring=1802C, Pin/O-Ring=1802A/B

→ P254-255

Z-SERIES
HAND
MANUALES
TITANIUM
DE TITANIO
ACCESSORIES
ACCESORIOS
SCREWDRIVERS
DESTORNILLADORES
IMPACT
DE IMPACTO
SLEEVE-DRIVE
INDUSTRIAL
INDUSTRIALES
PROTECTOR
PROTECTORES
AUTOMOTIVE
CONSTRUCTION
CONSTRUCCION
RENEWAL KITS
JUEGOS DE REPARACION

18301M • 18301A

6-point Deep Sockets, Thin Walled
Vasos Hexagonales Largos de Paraf De Igada

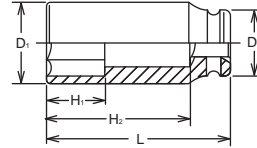

18301M (mm)	D ₁ (mm)	D ₂ (mm)	H ₁ (mm)	H ₂ (mm)	L (mm)	(g)	(pcs.)	
17	29.8	53	17	77	108	692	2	*1
18	31	53	18	77	108	710	2	*1
19	32.3	53	19	77	108	725	2	*1
20	33.5	53	20	77	108	740	2	*1
21	34.8	53	21	77	108	750	2	*1
22	36	53	22	77	108	770	2	*1
23	37.3	53	23	77	108	780	2	*1
24	38.5	53	24	77	108	800	2	*1
26	41	53	26	77	108	830	2	*1
27	42.3	53	27	77	108	860	2	*1
29	44.8	53	29	77	108	880	2	*1
30	46	53	30	77	108	910	2	*1
32	48.5	53	32	77	108	970	2	*1
33	49.8	53	33	77	108	980	2	*1
34	51	53	34	77	108	980	2	*1
35	52.3	53	35	77	108	986	2	*1
36	53.5	53	36	76	108	992	2	*1
38	56	53	38	76	108	1025	2	*1
39	57.3	53	38	76	108	1130	2	*1
41	59.8	53	38	75	108	1213	2	*1
42	61	53	38	75	108	1245	2	*1
43	62.3	53	38	74	108	1400	2	*1
46	66	53	38	74	108	1400	2	*1
50	71	53	38	-	108	1435	2	*1
55	77.3	53	62	-	108	1735	2	*1
60	83.5	53	59	-	108	1985	2	*1
65	89.8	53	56	-	108	2090	2	*1
70	96	53	55	-	108	2310	1	*1

*1 C-Ring=1801C, Pin/O-Ring=1801A/B → P254-255

18301A (inch)	D ₁ (mm)	D ₂ (mm)	H ₁ (mm)	H ₂ (mm)	L (mm)	(g)	(pcs.)	
11/16	29.8	53	17	77	108	692	2	*1
3/4	32.3	53	19	77	108	725	2	*1
13/16	34.8	53	21	77	108	750	2	*1
7/8	36	53	22	77	108	770	2	*1
15/16	38.5	53	24	77	108	800	2	*1
1	39.8	53	25	77	108	828	2	*1
1. 1/16	42.3	53	27	77	108	860	2	*1
1. 1/8	44.8	53	29	77	108	909	2	*1
1. 3/16	46	53	30	77	108	910	2	*1
1. 1/4	48.5	53	32	77	108	970	2	*1
1. 9/32	49.8	53	33	77	108	997	2	*1
1. 5/16	51	53	34	77	108	1014	2	*1
1. 3/8	52.3	53	35	77	108	986	2	*1
1. 7/16	54.8	53	37	76	108	1000	2	*1
1. 1/2	56	53	38	76	108	1025	2	*1
1. 9/16	58.5	53	38	75	108	1200	2	*1
1. 5/8	59.8	53	38	75	108	1213	2	*1
1.11/16	62.3	53	38	74	108	1285	2	*1
1. 3/4	64.8	53	38	74	108	1360	2	*1
1.13/16	66	53	38	74	108	1400	2	*1

*1 C-Ring=1801C, Pin/O-Ring=1801A/B → P254-255

18310M

Surface Drive Sockets, deep
Vasos Surface Drive (de Contacto Curvo) Largos

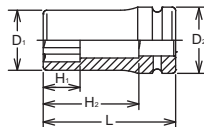

18310M (mm)	D ₁ (mm)	D ₂ (mm)	H ₁ (mm)	H ₂ (mm)	L (mm)	(g)	(pcs.)	
24	41.5	54	24	77	108	1060	2	*1
27	45.3	54	27	77	108	1125	2	*1
30	49	54	30	77	108	1179	2	*1
32	51.5	54	32	77	108	1200	2	*1
33	52.8	54	33	77	108	1200	2	*1
36	56.5	54	36	76	108	1280	2	*1
41	62.8	54	38	75	108	1450	2	*1

*1 C-Ring=1801C, Pin/O-Ring=1801A/B → P254-255



SURFACE DRIVE

18106.16 (mm)	D (mm)	H (mm)	L (mm)	(g)	(pcs.)	
10	54	24	92	686	2	*1
12	54	24	92	692	2	*1
13	54	24	92	696	2	*1
14	54	24	92	700	2	*1
16	54	24	92	709	2	*1
17	54	24	92	713	2	*1
18	54	24	92	718	2	*1
19	54	24	92	764	2	*1
22	54	24	92	781	2	*1

18106.16 (inch)	D (mm)	H (mm)	L (mm)	(g)	(pcs.)	
1/2	54	24	92	696	2	*1
9/16	54	24	92	700	2	*1
5/8	54	24	92	709	2	*1
3/4	54	24	92	764	2	*1

*1 C-Ring=1801C, Pin/O-Ring=1801A/B → P254-255

18106.16 (T)	D (mm)	H (mm)	L (mm)	(g)	(pcs.)	
T55	54	34	102	697	2	*1
T60	54	34	102	704	2	*1
T70	54	34	102	713	2	*1

*1 C-Ring=1801C, Pin/O-Ring=1801A/B → P254-255

18106.16 (XZN)	D (mm)	H (mm)	L (mm)	(g)	(pcs.)	
M14	54	44	112	723	2	*1
M16	54	44	112	733	2	*1
M18	54	44	112	743	2	*1

*1 C-Ring=1801C, Pin/O-Ring=1801A/B → P254-255

18106	D ₁ (mm)	D ₂ (mm)	H (mm)	L (mm)	(g)	(pcs.)	
18106	32	54	16	68	640	2	*1

*1 C-Ring=1801C, Pin/O-Ring=1801A/B → P254-255

 Replacement Screw : M6x10, ● 3mm

18106-16 Hex Bit Sockets Vasos con Punta Hexagonal

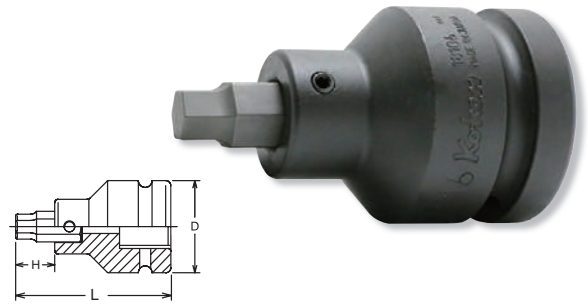

18106-16(T) TORX® Bit Sockets Vasos con Punta TORX®

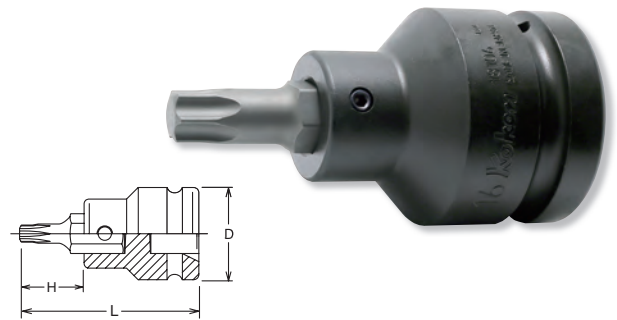

18106-16(XZN) XZN Bit Sockets Vasos con Punta XZN

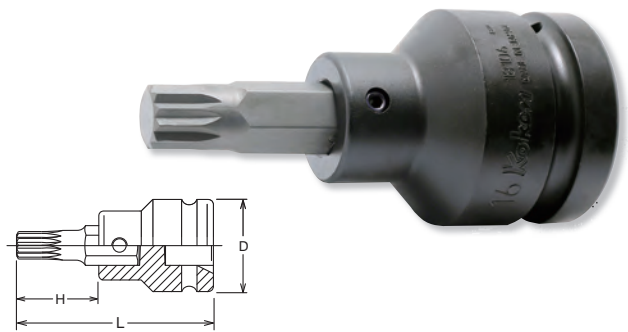

18106 Bit Holder Porta Punta

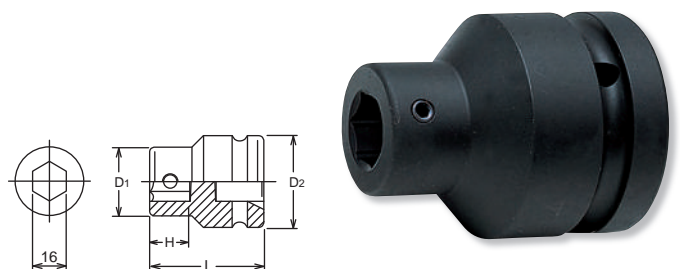

Z-SERIES
HAND
MANUALES
TITANIUM
DE TITANIO
ACCESSORIES
ACCESORIOS
SCREWDRIVERS
DESTORNILLADORES
IMPACT
DE IMPACTO
SLEEVE-DRIVE
INDUSTRIAL
INDUSTRIALES
PROTECTOR
PROTECTORES
AUTOMOTIVE
CONSTRUCTION
CONSTRUCCION
RENEWAL KITS
JUEGOS DE PIEZAS/REUESTO

107-16 Bits for Inhex Screws Puntas para Tornillos Inhex

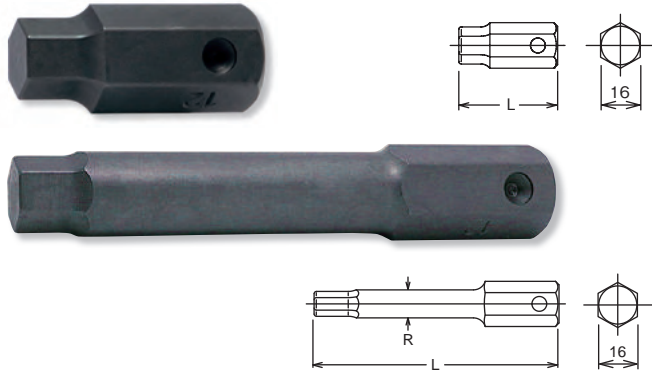

107.16 (mm)	L (mm)	(g)	(pcs.)
10	40	46	10
12	40	52	10
13	40	56	10
14	40	60	10
16	40	69	10
17	40	73	10
18	40	78	10
19	40	80	10
22	40	97	10

107.16 (inch)	L (mm)	(g)	(pcs.)
3/8	40	45	10
1/2	40	56	10
9/16	40	60	10
5/8	40	69	10
3/4	40	80	10

107.16(L100) (mm)	L (mm)	R (mm)	(g)	(pcs.)
10	100	13	122	10
12	100	15	146	10
14	100	-	166	10
17	100	-	193	10
19	100	-	232	10
22	100	-	254	10

107-16 (T) TORX® Bits Puntas TORX®

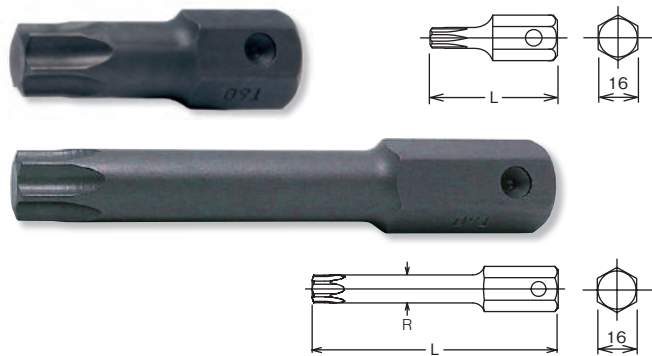

107.16 (T)	L (mm)	(g)	(pcs.)
T55	50	57	10
T60	50	64	10
T70	50	73	10

107.16(L100) (T)	L (mm)	R (mm)	(g)	(pcs.)
T55	100	11.4	108	10
T60	100	13.4	130	10
T70	100	15.7	159	10

107-16 (IP) TORXPLUS® Bits Puntas TORXPLUS®



107.16 (IP)	L (mm)	(g)	(pcs.)
55IP	50	57	10
60IP	50	64	10
70IP	50	73	10

107-16 (XZN) XZN Bits Puntas XZN

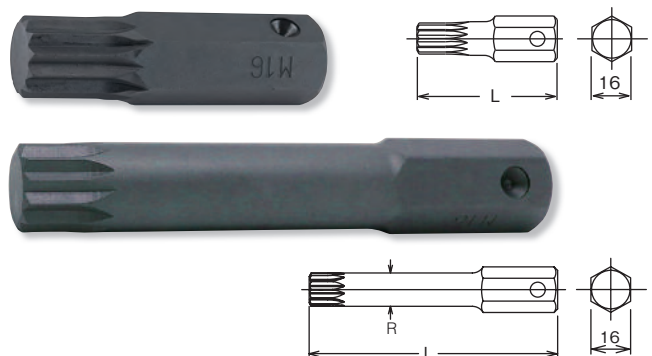

107.16 (XZN)	L (mm)	(g)	(pcs.)
M14	60	83	10
M16	60	93	10
M18	60	103	10

107.16(L100) (XZN)	L (mm)	R (mm)	(g)	(pcs.)
M14	100	13.4	131	10
M16	100	15.8	161	10
M18	100	17.1	177	10

TORX® is a registered trademark of Acument Intellectual Properties, LLC.
TORX® es una marca registrada de Acument Intellectual Properties, LLC.

TORXplus® is a registered trademark of Acument Intellectual Properties, LLC.
TORXplus® es una marca registrada de Acument Intellectual Properties, LLC.

18107.22 (mm)	D (mm)	H (mm)	L (mm)	(g)	(pcs.)	
19	54	28	98	910	2	*1
22	54	28	98	932	2	*1
24	54	28	98	946	2	*1
27	54	28	98	986	2	*1
30	54	28	98	1008	2	*1
32	54	28	103	1029	2	*1

*1 C-Ring=1801C, Pin/O-Ring=1801A/B → P254-255

18107-22 Hex Bit Sockets Vasos con Punta Hexagonal

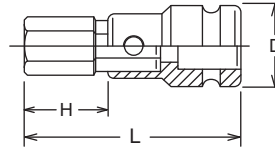

18107	D ₁ (mm)	D ₂ (mm)	H (mm)	L (mm)	(g)	(pcs.)	
18107	44	54	22	70	770	2	*1

*1 C-Ring=1801C, Pin/O-Ring=1801A/B → P254-255

Replacement Screw : M8x14, ●4mm

18107 Bit Holder Porta Punta

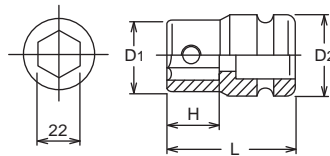

107.22 (mm)	L (mm)	(g)	(pcs.)
17	50	120	10
19	50	140	10
22	50	162	10
24	50	176	10
27	50	200	10
30	50	227	10
32	55	243	10

107.22 (inch)	L (mm)	(g)	(pcs.)
5/8	50	120	10
3/4	50	140	10
7/8	50	162	10
1	50	190	10
1. 1/4	55	243	10

107-22 Bits for Inhex Screws Puntas para Tornillos Inhex

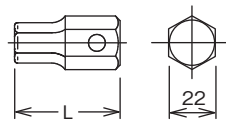

107.22 (T)	L (mm)	(g)	(pcs.)
New T 70	60	129	10
T 80	60	141	10
T 90	60	155	10
T100	60	170	10

107-22 (T) TORX® Bits Puntas TORX®

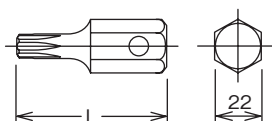

Z-SERIES
HAND
MANUALES
TITANIUM
DE TITANIO
ACCESSORIES
ACCESORIOS
SCREWDRIVERS
DESTORNILLADORES
IMPACT
DE IMPACTO
SLEEVE-DRIVE
INDUSTRIAL
INDUSTRIALES
PROTECTOR
PROTECTORES
AUTOMOTIVE
CONSTRUCTION
CONSTRUCCION
RENEWAL KITS
JUEGOS DE PIEZAS/REPOSTO

Z-SERIES
HAND MANUALES
TITANIUM DE TITANIO
ACCESSORIES ACCESORIOS
SCREWDRIVERS DESTORNILLADORES
IMPACT DE IMPACTO
SLEEVE-DRIVE
INDUSTRIAL INDUSTRIALES
PROTECTOR PROTECTORES
AUTOMOTIVE
RENEWAL KITS CONSTRUCTION JUEGOS DE PIEZAS REPUESTO CONSTRUCCIÓN

18760 Extension Bars Alargaderas

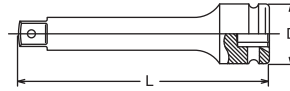

18760	D (mm)	L (mm)	(g)	(pce.)	⚡
175	54	175	1400	1	*1
200	54	200	1580	1	*1
250	54	250	1885	1	*1
330	54	330	2380	1	*1

*1 C-Ring=1801C, Pin/O-Ring=1801A/B → P254-255

18888AL Adaptor (Quick Release) Adaptador (Extracción Rápida) ⚠

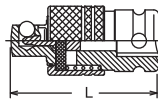

18888AL	L (mm)	(g)	(pce.)	⚡
18888AL	95	980	2	*1

*1 C-Ring=1801C, Pin/O-Ring=1801A/B → P254-255

Lock & Quick Release

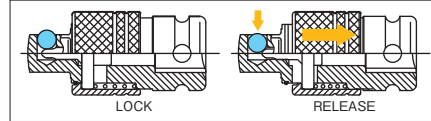

⚠ You may not hold the sliding part while moving to avoid heating up by friction and reduction by wear.

18770 Universal Joint Articulación Universal

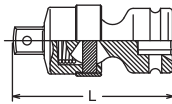

18770	L (mm)	(g)	(pce.)	⚡
18770	127	1350	1	*1
18771	115	1210	1	*1

*1 C-Ring=1801C, Pin/O-Ring=1801A/B → P254-255

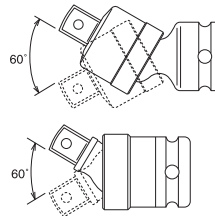

18771 Universal Joint Articulación Universal

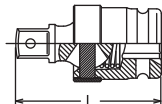

	(sq.)	(sq.)	L (mm)	(g)	(pce.)	
18866A	1"	3/4"	67	580	1	*1
18866A-200	1"	3/4"	200	1100	1	*1

*1 C-Ring=1801C, Pin/O-Ring=1801A/B → P254-255

⚠ Adapting down from bigger square drive to smaller square drive may lead to excessive torque load and possibly cause breakage. Always stay within safe torque of the smaller square drive.

18866A Adaptors Adaptadores No Warranty Sin Garantia ⚠

18866A-200 ⚠

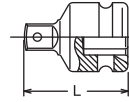

	(sq.)	(sq.)	L (mm)	(g)	(pce.)	
18877A	1"	1.1/2"	80	935	1	*1

*1 C-Ring=1801C, Pin/O-Ring=1801A/B → P254-255

18877A Adaptor Adaptador

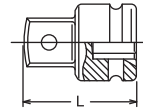

Z-SERIES
HAND
MANUALES
TITANIUM
DE TITANIO
ACCESSORIES
ACCESORIOS
SCREWDRIVERS
DESTORNILLADORES
IMPACT
DE IMPACTO
SLEEVE-DRIVE
INDUSTRIAL
INDUSTRIALES
PROTECTOR
PROTECTORES
AUTOMOTIVE
CONSTRUCTION
CONSTRUCCION
RENEWAL KITS
JUEGOS DE PIEZAS/REPOSTO

Impact Sockets 1-1/2"

17400M • 17400A

6-point Sockets
Vasos Hexagonales

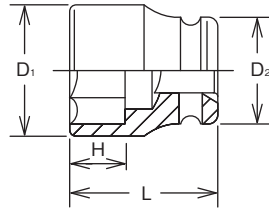

17400M (mm)	D ₁ (mm)	D ₂ (mm)	H (mm)	L (mm)	(g)	(pce.)	
36	62	86	20	77	2126	1	*1
41	68	86	22	80	2346	1	*1
42	70	86	22	80	2330	1	*1
46	74	86	26	84	2360	1	*1
50	79	86	27	84	2400	1	*1
52	82	86	38	84	2340	1	*1
54	84	86	38	84	2340	1	*1
55	85	86	44	90	2450	1	*1
58	88	86	44	90	2510	1	*1
60	91	86	43	90	2640	1	*1
65	97	86	48	95	3050	1	*1
70	103	86	52	100	3350	1	*1
75	108	86	56	105	3700	1	*1
80	115	86	60	110	4240	1	*1
85	122	86	60	110	4550	1	*1
90	128	86	60	112	4840	1	*1
95	135	127	52	112	7660	1	*2
100	140	127	53	115	7700	1	*2
105	146	127	57	120	8000	1	*2
110	153	127	60	124	9200	1	*2
115	160	127	62	128	10700	1	*2
120	166	127	64	132	11200	1	*2
125	173	127	67	136	13000	1	*2
130	180	127	69	140	14200	1	*2
135	186	127	73	145	14940	1	*2
140	190	127	76	150	15600	1	*2
150	200	127	83	160	16500	1	*2

17400A (inch)	D ₁ (mm)	D ₂ (mm)	H (mm)	L (mm)	(g)	(pce.)	
1. 5/8	68	86	22	80	2346	1	*1
1.11/16	71	86	22	80	2300	1	*1
1. 3/4	73	86	22	80	2290	1	*1
1.13/16	74	86	26	84	2360	1	*1
1. 7/8	77	86	26	84	2440	1	*1
1.15/16	79	86	27	84	2400	1	*1
2	80	86	27	84	2420	1	*1
2. 1/16	82	86	38	84	2340	1	*1
2. 1/8	84	86	38	84	2340	1	*1
2. 3/16	85	86	44	90	2450	1	*1
2. 1/4	87	86	43	90	2460	1	*1
2. 5/16	88	86	44	90	2510	1	*1
2. 3/8	91	86	43	90	2640	1	*1
2. 7/16	93	86	47	95	2860	1	*1
2. 1/2	96	86	47	95	3000	1	*1
2. 9/16	97	86	48	95	3050	1	*1
2. 5/8	100	86	51	100	3300	1	*1
2.11/16	101	86	51	100	3300	1	*1
2. 3/4	103	86	52	100	3350	1	*1
2.13/16	105	86	55	105	3670	1	*1
2. 7/8	106	86	55	105	3610	1	*1
2.15/16	108	86	56	105	3700	1	*1
3	108	86	55	105	3680	1	*1
3. 1/8	115	86	60	110	4240	1	*1
3. 1/4	118	86	59	110	4370	1	*1
3. 3/8	123	86	60	110	4570	1	*1
3. 1/2	128	86	60	112	4840	1	*1
3. 5/8	132	86	52	112	5500	1	*1
3. 3/4	135	127	52	112	7660	1	*2
3. 7/8	140	127	53	115	7700	1	*2
4	146	127	57	120	8000	1	*2
4. 1/8	146	127	57	120	8000	1	*2
4. 1/4	153	127	60	124	9200	1	*2
4. 1/2	160	127	62	128	10700	1	*2
4. 5/8	166	127	64	132	11200	1	*2
4. 3/4	168	127	64	132	11200	1	*2
4. 7/8	173	127	67	136	13000	1	*2
5	180	127	69	140	14200	1	*2
6	205	127	88	165	16500	1	*2

*1 C-Ring=1700C, Pin/O-Ring=1701A/B
*2 Pin/O-Ring=1702A/B

➔ P254-255

1-1/2" Impact Sockets

17405M (mm)	D ₁ (mm)	D ₂ (mm)	H (mm)	L (mm)	(g)	(pce.)	
46	74	86	26	84	2360	1	*1
50	79	86	27	84	2400	1	*1
55	85	86	44	90	2450	1	*1
60	91	86	43	90	2640	1	*1
65	97	86	48	95	3050	1	*1
70	103	86	52	100	3350	1	*1
75	108	86	56	105	3700	1	*1
80	115	86	60	110	4240	1	*1
85	122	86	60	110	4550	1	*1
90	128	86	60	112	4840	1	*1
95	135	127	52	112	7660	1	*2
100	140	127	53	115	7700	1	*2

17405A (inch)	D ₁ (mm)	D ₂ (mm)	H (mm)	L (mm)	(g)	(pce.)	
1.11/16	71	86	22	80	2300	1	*1
1. 3/4	73	86	22	80	2290	1	*1
1. 7/8	77	86	26	84	2440	1	*1
1.15/16	79	86	27	84	2400	1	*1
2	80	86	27	84	2420	1	*1
2. 1/16	82	86	38	84	2340	1	*1
2. 1/8	84	86	38	84	2340	1	*1
2. 3/16	85	86	44	90	2450	1	*1
2. 1/4	87	86	43	90	2460	1	*1
2. 3/8	91	86	43	90	2640	1	*1
2. 7/16	93	86	47	95	2860	1	*1
2. 1/2	96	86	47	95	3000	1	*1
2. 9/16	97	86	48	95	3050	1	*1
2. 5/8	100	86	51	100	3300	1	*1
2.15/16	108	86	56	105	3700	1	*1

*1 C-Ring=1700C, Pin/O-Ring=1701A/B
*2 Pin/O-Ring=1702A/B

→ P254-255

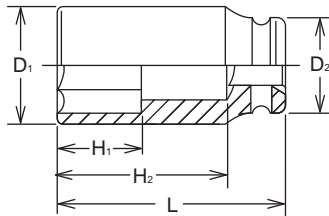

17405M • 17405A 12-point Sockets Vasos Bihexagonales

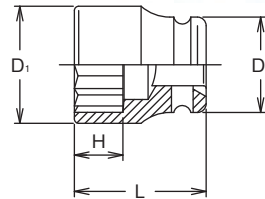

17300M • 17300A 6-point Deep Sockets Vasos Hexagonales Largos



17300M (mm)	D ₁ (mm)	D ₂ (mm)	H ₁ (mm)	H ₂ (mm)	L (mm)	(g)	(pce.)	
36	63	86	26	70.5	115	2800	1	*1
41	68	86	27	70.5	115	3080	1	*1
42	70	86	27	70.5	115	3140	1	*1
46	74	86	28	80.5	125	3440	1	*1
50	79	86	30	90.5	135	3840	1	*1
54	84	86	30	90.5	135	4160	1	*1
55	85	86	33	90.5	135	4130	1	*1
60	91	86	35	90.5	135	4370	1	*1
65	97	86	38	99.5	145	5260	1	*1
70	103	86	40	98.5	145	5780	1	*1
75	108	86	42	107.5	155	6580	1	*1
80	115	86	46	115.5	165	7740	1	*1
85	122	86	49	114.5	165	7420	1	*1
90	128	86	52	122.5	175	9630	1	*1
95	135	127	55	121.5	175	10450	1	*2
100	140	127	58	130.5	185	9741	1	*2
105	146	127	62	138.5	195	10850	1	*2
110	153	127	65	137.5	195	11500	1	*2
115	160	127	68	135.5	195	12160	1	*2
120	166	127	72	144.5	205	13680	1	*2
125	173	127	74	142.5	205	14450	1	*2
130	180	127	76	142.5	205	15190	1	*2

*1 C-Ring=1700C, Pin/O-Ring=1701A/B
*2 Pin/O-Ring=1702A/B

→ P254-255

17300A (inch)	D ₁ (mm)	D ₂ (mm)	H ₁ (mm)	H ₂ (mm)	L (mm)	(g)	(pce.)	
1. 5/8	68	86	27	70.5	115	3080	1	*1
1.11/16	71	86	27	70.5	115	3180	1	*1
1. 3/4	73	86	27	70.5	115	3210	1	*1
1.13/16	74	86	28	80.5	125	3440	1	*1
1. 7/8	77	86	28	80.5	125	3550	1	*1
1.15/16	79	86	28	80.5	125	3590	1	*1
2	80	86	30	90.5	135	3916	1	*1
2. 1/16	82	86	30	90.5	135	4030	1	*1
2. 1/8	84	86	30	90.5	135	4160	1	*1
2. 3/16	85	86	33	90.5	135	4200	1	*1
2. 1/4	87	86	33	90.5	135	4160	1	*1
2. 3/8	91	86	35	90.5	135	4370	1	*1
2. 7/16	93	86	35	90.5	135	4490	1	*1
2. 1/2	96	86	35	90.5	135	4630	1	*1
2. 9/16	97	86	38	99.5	145	5260	1	*1
2. 5/8	100	86	38	99.5	145	5320	1	*1
2.11/16	101	86	38	99.5	145	5670	1	*1
2. 3/4	103	86	40	98.5	145	5780	1	*1
2.13/16	105	86	40	98.5	145	6000	1	*1
2. 7/8	106	86	40	98.5	145	6080	1	*1
2.15/16	108	86	42	107.5	155	6580	1	*1
3	108	86	42	107.5	155	6850	1	*1
3. 1/8	115	86	46	115.5	165	7740	1	*1
3. 3/4	135	127	55	121.5	175	12200	1	*2
3. 7/8	140	127	56	120.5	175	11080	1	*2

*1 C-Ring=1700C, Pin/O-Ring=1701A/B
*2 Pin/O-Ring=1702A/B

→ P254-255

Z-SERIES
HAND
MANUALES
TITANIUM
DE TITANIO
ACCESSORIES
ACCESORIOS
SCREWDRIVERS
DESTORNILLADORES
IMPACT
DE IMPACTO
SLEEVE-DRIVE
INDUSTRIAL
INDUSTRIALES
PROTECTOR
PROTECTORES
AUTOMOTIVE
CONSTRUCTION
CONSTRUCCION
RENEWAL KITS
JUEGOS DE REPARACION

Impact Sockets 1-1/2"

Z-SERIES
HAND MANUALES
TITANIUM DE TITANIO
ACCESSORIES ACCESORIOS
SCREWDRIVERS DESTORNILLADORES
IMPACT DE IMPACTO
SLEEVE-DRIVE
INDUSTRIAL INDUSTRIALES
PROTECTOR PROTECTORES
AUTOMOTIVE
RENEWAL KITS CONSTRUCTION JUEGOS DE PIEZAS REPUESTO CONSTRUCCIÓN

17108-32 Hex Bit Sockets Vasos con Punta Hexagonal

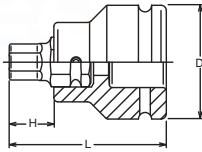



17108.32 (mm)	D (mm)	H (mm)	L (mm)	(g)	(pce.)	
19	86	30	115	2500	1	*1
22	86	30	115	2520	1	*1
24	86	30	115	2530	1	*1
27	86	30	115	2560	1	*1
30	86	30	115	2590	1	*1
32	86	30	115	2610	1	*1
36	86	30	115	2660	1	*1

*1 C-Ring=1700C, Pin/O-Ring=1701A/B  P254-255

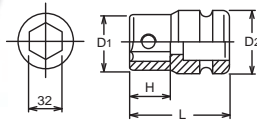
17108 Bit Holder, For 107-32 Porta Punta



	D ₁ (mm)	D ₂ (mm)	H (mm)	L (mm)	(g)	(pce.)	
17108	60	86	30	85	2200	1	*1

*1 C-Ring=1700C, Pin/O-Ring=1701A/B  P254-255

 Replacement Screw : M8x14,  4mm

107-32 Bit for Inhex Screws Puntas para Tornillos Inhex

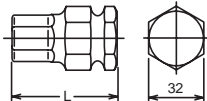

107.32 (mm)	L (mm)	(g)	(pcs.)
19	60	300	10
22	60	320	10
24	60	330	10
27	60	360	10
30	60	390	10
32	60	410	10
36	60	460	10



1-1/2" Impact Sockets

17760	D (mm)	L (mm)	(g)	(pce.)	⚡
175	86	175	3300	1	*1
250	86	250	4500	1	*1
330	86	330	5200	1	*1

*1 C-Ring=1700C, Pin/O-Ring=1701A/B → P254-255

17760 Extension Bars
Alargaderas

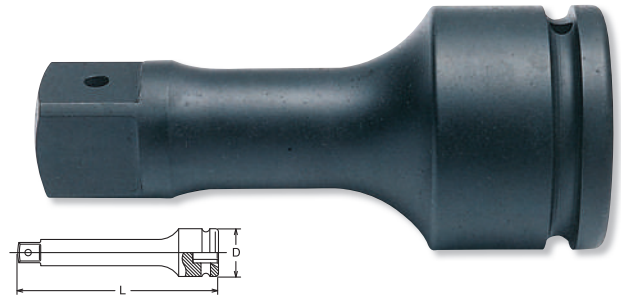

17770	L (mm)	(g)	(pce.)	⚡
17770	200	4700	1	*1

*1 C-Ring=1700C, Pin/O-Ring=1701A/B → P254-255

17770 Universal Joint
Articulación Universal

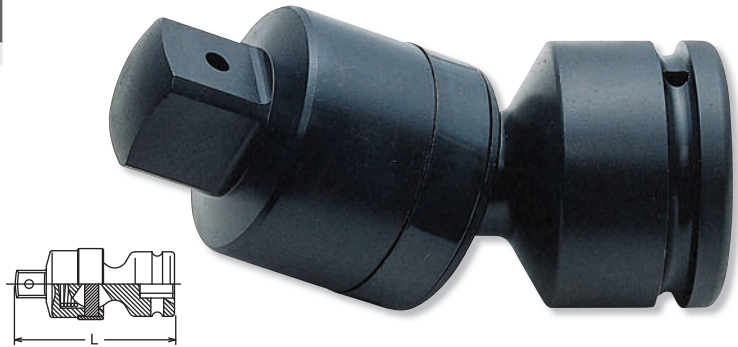

17788A	(sq.)	(sq.)	L (mm)	(g)	(pce.)	⚡
17788A	1.1/2"	1"	98	2600	1	*1

*1 C-Ring=1700C, Pin/O-Ring=1701A/B → P254-255

⚠ Adapting down from bigger square drive to smaller square drive may lead to excessive torque load and possibly cause breakage. Always stay within safe torque of the smaller square drive.

17788A Adaptor
Adaptador **No Warranty Sin Garantía** ⚠



17799A	(sq.)	(sq.)	L (mm)	(g)	(pce.)	⚡
17799A	1.1/2"	2.1/2"	115	3790	1	*1

*1 C-Ring=1700C, Pin/O-Ring=1701A/B → P254-255

17799A Adaptor
Adaptador





Z-SERIES
HAND
MANUALES
TITANIUM
DE TITANIO
ACCESSORIES
ACCESORIOS
SCREWDRIVERS
DESTORNILLADORES
IMPACT
DE IMPACTO
SLEEVE-DRIVE
INDUSTRIAL
INDUSTRIALES
PROTECTOR
PROTECTORES
AUTOMOTIVE
CONSTRUCTION
CONSTRUCCION
RENEWAL KITS
JUEGOS DE REPARACION

Impact Sockets **2-1/2"**

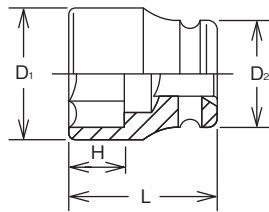
19400M • 19400A 6-point Sockets Vasos Hexagonales



19400M (mm)	D ₁ (mm)	D ₂ (mm)	H (mm)	L (mm)	(g)	(pce.)	
50	88	127	39	115	7270	1	*1
55	94	127	42	115	7350	1	*1
60	100	127	45	125	7870	1	*1
65	105	127	48	125	7790	1	*1
70	110	127	51	125	7640	1	*1
75	118	127	54	125	7740	1	*1
80	124	127	57	125	7640	1	*1
85	127	127	61	132	7840	1	*1
90	135	127	64	132	8500	1	*1
95	140	127	71	140	10160	1	*1
100	146	127	71	142	11500	1	*1
105	155	127	74	146	11350	1	*1
110	160	127	76	155	12710	1	*1
115	167	127	78	158	13980	1	*1
120	175	175	79	160	15430	1	*2
125	180	175	82	165	16590	1	*2
130	185	175	85	169	17590	1	*2
135	190	175	89	175	19030	1	*2
140	200	175	93	180	21810	1	*2
145	205	175	95	183	24440	1	*2
150	210	175	97	192	25720	1	*2
160	225	175	102	200	30920	1	*2
165	230	175	105	204	32610	1	*2
170	235	175	106	207	34390	1	*2
175	240	175	109	211	36210	1	*2
180	250	175	110	214	40630	1	*2
185	255	175	113	218	42690	1	*2
190	265	175	113	220	47440	1	*2
200	275	175	116	225	51550	1	*2
210	285	175	123	235	57170	1	*2
215	290	175	126	240	60260	1	*2
225	305	175	133	250	70180	1	*2
235	315	175	140	260	77060	1	*2

19400A (inch)	D ₁ (mm)	D ₂ (mm)	H (mm)	L (mm)	(g)	(pce.)	
2. 1/8	92	127	41	115	6665	1	*1
2. 3/8	100	127	45	125	7870	1	*1
2. 7/16	102	127	46	125	7840	1	*1
2. 1/2	103	127	47	125	7810	1	*1
2. 9/16	105	127	48	125	7790	1	*1
2. 5/8	107	127	49	125	7790	1	*1
2.11/16	108	127	50	125	7790	1	*1
2. 3/4	110	127	51	125	7640	1	*1
2.13/16	113	127	52	125	7690	1	*1
2. 7/8	115	127	53	125	7730	1	*1
2.15/16	118	127	54	125	7740	1	*1
3	120	127	55	125	7740	1	*1
3. 1/8	124	127	57	125	7640	1	*1
3. 1/4	125	127	59	125	7740	1	*1
3. 3/8	127	127	61	132	7840	1	*1
3. 1/2	135	127	64	132	8500	1	*1
3. 5/8	138	127	64	132	9330	1	*1
3. 3/4	140	127	71	140	10160	1	*1
3. 7/8	143	127	70	140	10830	1	*1
4	146	127	71	142	11500	1	*1
4. 1/8	155	127	70	142	11250	1	*1
4. 1/4	160	127	76	155	12710	1	*1
4. 3/8	163	127	76	155	13100	1	*1
4. 1/2	167	127	78	158	13980	1	*1
4. 5/8	175	175	79	160	15430	1	*2
4. 7/8	180	175	82	165	16590	1	*2
5	183	175	81	165	17090	1	*2
5. 1/4	190	175	89	175	19030	1	*2
5. 3/8	198	175	94	180	20880	1	*2
5. 1/2	200	175	93	180	21810	1	*2
5. 5/8	203	175	94	182	22480	1	*2
5. 3/4	207	175	103	192	24440	1	*2
6	217	175	100	196	28510	1	*2
6. 1/8	218	175	99	196	29720	1	*2
6. 5/8	233	175	105	205	33500	1	*2
7	248	175	110	213	39160	1	*2

*1 Pin/O-Ring=1901A/B
*2 Pin/O-Ring=1902A/B 

2-1/2" Impact Sockets

19300M (mm)	D ₁ (mm)	D ₂ (mm)	H ₁ (mm)	H ₂ (mm)	L (mm)	(g)	(pce.)	⚡
75	118	127	42	129	190	11930	1	*1
80	124	127	46	129	190	12280	1	*1
85	127	127	49	134	195	12480	1	*1
90	135	127	52	144	205	14000	1	*1
95	140	127	55	149	210	14630	1	*1
100	146	127	58	154	215	15520	1	*1
105	155	127	62	146.5	220	18250	1	*1
110	160	127	65	150.5	225	18740	1	*1
115	167	127	68	153.5	230	20940	1	*1
120	175	175	72	157.5	235	23530	1	*2
125	180	175	74	158.5	238	26110	1	*2
130	185	175	76	163.5	243	25320	1	*2
135	190	175	80	165.5	248	26290	1	*2
140	200	175	82	164.5	248	28940	1	*2
145	205	175	84	163.5	248	29520	1	*2
150	210	175	88	168.5	255	30600	1	*2
155	215	175	92	167.5	255	31680	1	*2
160	225	175	95	170.5	260	35560	1	*2
165	230	175	98	169.5	260	36040	1	*2
170	235	175	100	172.5	265	37230	1	*2
175	240	175	102	176.5	270	39420	1	*2

*1 Pin/O-Ring=1901A/B → P255
 *2 Pin/O-Ring=1902A/B

19760	D (mm)	L (mm)	(g)	(pce.)	⚡
250	127	250	17800	1	*1
500	127	500	27800	1	*1

*1 Pin/O-Ring=1901A/B → P255

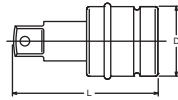

19770	L (mm)	(g)	(pce.)	⚡
19770	303	21360	1	*1

*1 Pin/O-Ring=1901A/B → P255

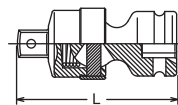

19977A	(sq.)	(sq.)	L (mm)	(g)	(pce.)	⚡
19977A	2.1/2"	1.1/2"	145	7210	1	*1

*1 Pin/O-Ring=1901A/B → P255

⚠ Adapting down from bigger square drive to smaller square drive may lead to excessive torque load and possibly cause breakage. Always stay within safe torque of the smaller square drive.

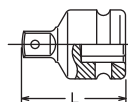

19300M 6-point Deep Sockets Vasos Hexagonales Largos

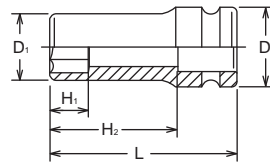

19760 Extension Bars Alargaderas



19770 Universal Joint Articulación Universal



19977A Adaptor Adaptador No Warranty Sin Garantía ⚠



Z-SERIES
 HAND
 MANUALES
 TITANIUM
 DE TITANIO
 ACCESSORIES
 ACCESORIOS
 SCREWDRIVERS
 DESTORNILLADORES
 IMPACT
 DE IMPACTO
 SLEEVE-DRIVE
 INDUSTRIAL
 INDUSTRIALES
 PROTECTOR
 PROTECTORES
 AUTOMOTIVE
 CONSTRUCTION
 CONSTRUCCION
 RENEWAL KITS
 JUEGOS DE REPARACION

Impact Sockets 3-1/2"

Z-SERIES
HAND MANUALES
TITANIUM DE TITANIO
ACCESSORIES ACCESORIOS
IMPACT DE IMPACTO
SLEEVE-DRIVE
INDUSTRIAL INDUSTRIALES
PROTECTOR PROTECTORES
AUTOMOTIVE
CONSTRUCTION CONSTRUCCION
RENEWAL KITS JUEGOS DE PIEZAS REPUESTO

10400M • 10400A

6-point Sockets
Vasos Hexagonales

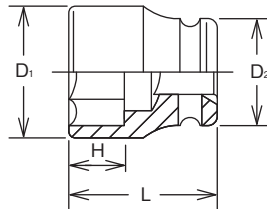

10400M (mm)	D ₁ (mm)	D ₂ (mm)	H (mm)	L (mm)	(g)	(pce.)	⚡
105	165	175	86	176	19370	1	*1
110	170	175	88	179	20160	1	*1
115	175	175	90	183	21160	1	*1
120	180	175	91	185	21930	1	*1
125	188	175	94	190	23940	1	*1
130	193	175	97	194	25050	1	*1
135	200	175	101	199	26930	1	*1
140	205	175	105	205	28560	1	*1
145	210	200	106	207	29600	1	*2
150	215	200	109	212	31240	1	*2
160	228	200	114	220	35500	1	*2
165	235	200	117	224	37940	1	*2
170	240	200	118	227	39660	1	*2
175	245	200	121	231	41400	1	*2
180	255	200	122	234	45740	1	*2
185	265	200	125	238	50350	1	*2
190	275	200	125	239	54650	1	*2
200	285	200	128	245	59190	1	*2
210	295	200	135	255	64970	1	*2
215	300	200	138	260	68150	1	*2

10400A (inch)	D ₁ (mm)	D ₂ (mm)	H (mm)	L (mm)	(g)	(pce.)	⚡
4.1/8	165	175	86	176	19370	1	*1
4.1/4	168	175	87	178	19770	1	*1
4.3/8	172	175	88	180	20660	1	*1
4.1/2	175	175	89	182	21160	1	*1
4.5/8	178	175	90	183	21550	1	*1
4.3/4	180	175	91	185	21930	1	*1
4.7/8	188	175	94	190	23940	1	*1
5	188	175	95	191	24500	1	*1
5.1/8	193	175	97	194	25050	1	*1
5.1/4	197	175	100	198	25990	1	*1
5.3/8	201	175	102	202	27750	1	*1
5.1/2	205	175	105	205	28560	1	*1
5.5/8	208	200	106	208	30110	1	*2
5.3/4	212	200	108	210	30610	1	*2
5.7/8	215	200	109	212	31240	1	*2
6	219	200	110	214	32460	1	*2
6.1/8	223	200	112	216	33670	1	*2
6.1/4	227	200	114	218	34590	1	*2
6.3/8	231	200	115	221	36720	1	*2
6.1/2	235	200	117	224	37940	1	*2
6.5/8	238	200	118	226	38800	1	*2
6.3/4	241	200	119	228	39870	1	*2
6.7/8	245	200	120	230	40640	1	*2
7	251	200	121	232	43570	1	*2
7.1/8	257	200	122	234	46450	1	*2
7.1/4	263	200	123	236	48400	1	*2
7.3/8	269	200	124	238	52500	1	*2
7.1/2	275	200	125	240	55350	1	*2
7.5/8	278	200	127	242	56050	1	*2
7.3/4	282	200	129	245	57620	1	*2
7.7/8	285	200	130	248	60870	1	*2
8	290	200	132	250	62550	1	*2
8.1/8	293	200	133	251	63760	1	*2
8.1/4	295	200	135	255	64970	1	*2
8.3/8	298	200	136	258	65580	1	*2
8.1/2	300	200	138	260	68150	1	*2
8.5/8	305	200	139	262	70760	1	*2
8.3/4	310	200	140	264	73830	1	*2
8.7/8	313	200	142	267	75780	1	*2

10099A

Adaptor
Adaptador

No Warranty
Sin Garantía

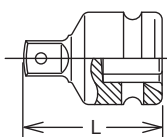
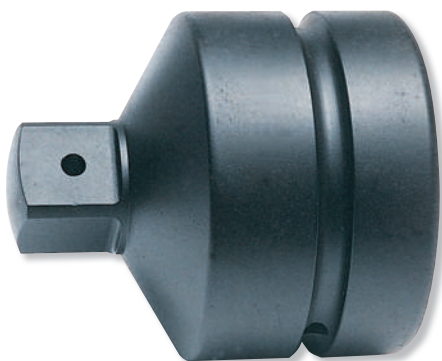

*1 Pin/O-Ring=2001A/B → P255
*2 Pin/O-Ring=2002A/B

10099A	(sq.)	(sq.)	L (mm)	(g)	(pce.)	⚡
10099A	3.1/2"	2.1/2"	182	16870	1	*1

*1 Pin/O-Ring=2001A/B → P255

⚠ Adapting down from bigger square drive to smaller square drive may lead to excessive torque load and possibly cause breakage. Always stay within safe torque of the smaller square drive.

3/8"

Sleeve Drive Sockets

1/2"

3/4"



Z-SERIES
HAND MANUALES
TITANIUM DE TITANIO
ACCESSORIES ACCESORIOS
SCREWDRIVERS DESTORNILLADORES
IMPACT DE IMPACTO
SLEEVE-DRIVE
INDUSTRIAL INDUSTRIALES
PROTECTOR PROTECTORES
AUTOMOTIVE
CONSTRUCTION CONSTRUCCIÓN
RENEWAL KITS JUEGOS DE PIEZAS REPUESTO



The deepened drive end of the **Sleeve-Drive** tools prevents the sometimes "wobbly" connection between pulse tool - extension - socket. An O-ring inside **Sleeve-Drive** optimizes the perfect fit of extension bars and sockets on the anvil to the effect, that the exactness of the required torque given by the pulse tool is generally improved. Further, the **Sleeve-Drive** avoids the direct transmission of vibrations on the pulse tool and finally on the operator.

El extremo de accionamiento alargado de las herramientas con **casquillo conductor** evita la unión a veces "holgada" entre la herramienta de percusión-alargadera-vaso. Una junta tórica en el interior del **casquillo conductor** optimiza el ajuste perfecto de las alargaderas y los vasos en el elemento de accionamiento lo que se traduce en la mejora de la exactitud del par requerido suministrado por la herramienta de percusión.

Sleeve Drive Sockets

Wrenches

O-Ring

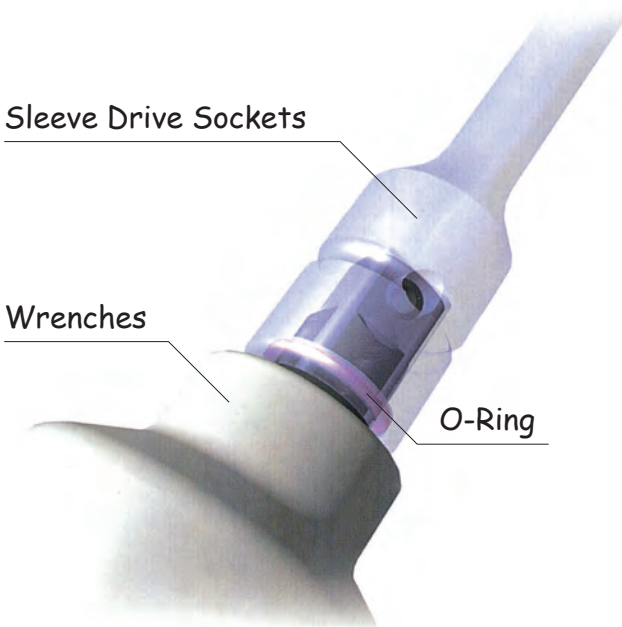

SLEEVE DRIVE SOCKET

PULSE TOOL

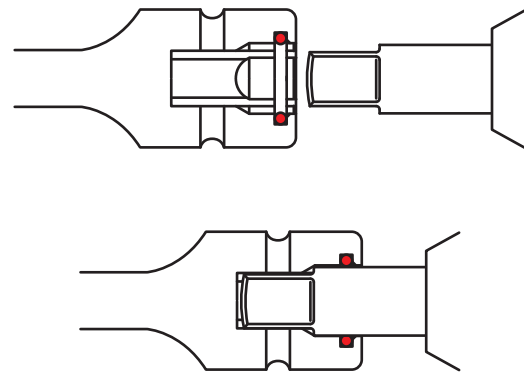

The "**Sleeve Drive**" Sockets and accessories are designed for use on Pulse Tools with anvils of certain lengths and diameters as shown hereunder.

Los Vasos y accesorios con Casquillo Conductor se han diseñado para su utilización con Herramientas de Percusión con elementos de accionamiento de cierta longitud y diámetro como se muestra a continuación.

	Anvil Diameter (mm)	Minimum Anvil Length-H (mm)
3/8"sq.	12	10
1/2"sq.	16	10
3/4"sq.	25	11.8

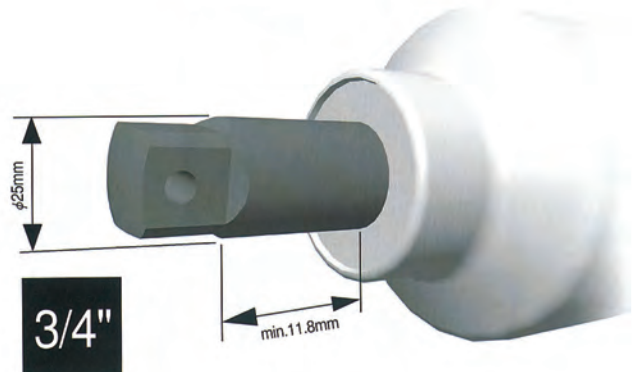
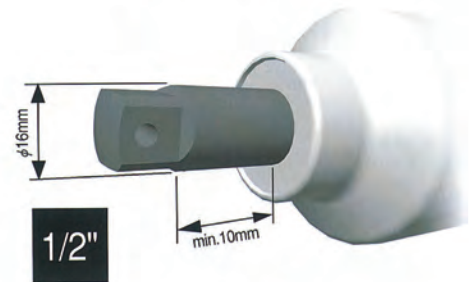
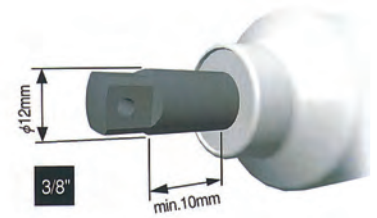

3/8" Sleeve Drive Sockets



NV13400 6-point Sockets Vasos Hexagonales

NV13400 (mm)	D ₁ (mm)	D ₂ (mm)	H (mm)	L (mm)	(g)	(pcs.)	
New 8	13.3	19	6	43	50	10	*1
10	15.8	19	7	43	53	10	*1
11	17	19	8	43	54	10	*1
12	18.3	19	9	43	55	10	*1
13	19.5	22	10	43	80	10	*2
14	20.8	22	10	43	80	10	*2
15	22	22	11	43	81	10	*2
16	23.3	22	11	43	83	10	*2
17	24.5	22	11	43	85	10	*2
18	25.8	22	11	43	89	10	*2
19	27	22	11	43	98	10	*2
21	29.5	22	11	43	105	10	*2
22	30.8	22	11	43	112	10	*2

*1 C-Ring=1301C, Pin/O-Ring=1301A/B
*2 C-Ring=1302C, Pin/O-Ring=1302A/B

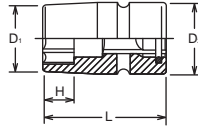

NV13145-100 • -150 • -200 Extended Sockets Vasos con Alargadera

NV13145.100 (mm)	D ₁ (mm)	D ₂ (mm)	H (mm)	L (mm)	(g)	(pcs.)	
6	13	19	6	100	108	10	*1
8	13	19	8	100	110	10	*1
10	15.5	19	10	100	112	10	*1
12	18	19	12	100	120	10	*1
13	19	19	13	100	127	10	*1
14	21	19	14	100	131	10	*1
15	22	19	15	100	133	10	*1
16	24	19	15	100	144	10	*1
17	25	19	15	100	154	10	*1

NV13145.150 (mm)	D ₁ (mm)	D ₂ (mm)	H (mm)	L (mm)	(g)	(pcs.)	
6	13	19	6	150	163	10	*1
8	13	19	8	150	158	10	*1
10	15.5	19	10	150	165	10	*1
12	18	19	12	150	168	10	*1
13	19	19	13	150	170	10	*1
14	21	19	14	150	175	10	*1
15	22	19	15	150	177	10	*1
16	24	19	15	150	190	10	*1
17	25	19	15	150	203	10	*1

NV13145.200 (mm)	D ₁ (mm)	D ₂ (mm)	H (mm)	L (mm)	(g)	(pcs.)	
6	13	19	6	200	209	10	*1
8	13	19	8	200	203	10	*1
10	15.5	19	10	200	212	10	*1
12	18	19	12	200	214	10	*1
13	19	19	13	200	218	10	*1
14	21	19	14	200	220	10	*1
15	22	19	15	200	226	10	*1
16	24	19	15	200	235	10	*1
17	25	19	15	200	250	10	*1

*1 C-Ring=1301C, Pin/O-Ring=1301A/B



NV13760	TYPE	D (mm)	L (mm)	(g)	(pcs.)	
75	Hole	19	75	95	10	*1
125	Hole	19	125	125	10	*1
150	Hole	19	150	150	10	*1
250	Hole	19	250	255	10	*1

NV13760	TYPE	D (mm)	L (mm)	(g)	(pcs.)	
75P	Pin	19	75	95	10	*1
125P	Pin	19	125	125	10	*1
150P	Pin	19	150	150	10	*1
250P	Pin	19	250	255	10	*1

*1 C-Ring=1301C, Pin/O-Ring=1301A/B

NV13760 Extension Bars Alargaderas



Z-SERIES
HAND
MANUALES
TITANIUM
DE TITANIO
ACCESSORIES
ACCESORIOS
SCREWDRIVERS
DESTORNILLADORES
IMPACT
DE IMPACTO
SLEEVE-DRIVE
INDUSTRIAL
INDUSTRIALES
PROTECTOR
PROTECTORES
AUTOMOTIVE
CONSTRUCTION
CONSTRUCCION
RENEWAL KITS
JUEGOS DE REPARACION

Sleeve Drive Sockets 3/8", 1/2"

Z-SERIES
HAND MANUALES
TITANIUM DE TITANIO
ACCESSORIES ACCESORIOS
IMPACT DE IMPACTO
SLEEVE-DRIVE
INDUSTRIAL INDUSTRIALES
PROTECTOR PROTECTORES
AUTOMOTIVE
CONSTRUCTION CONSTRUCCIÓN
RENEWAL KITS JUEGOS DE PIEZAS REPUÉS

183H-35 · -75 · -150

Hex Bits
Puntas Hexagonales

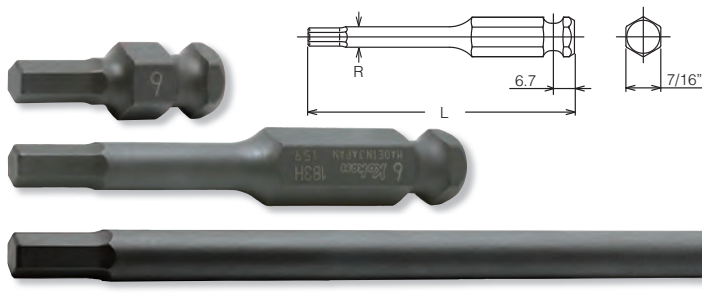

183H.35 (inch)	L (mm)	(g)	(pcs.)
3/16	35	15	10
7/32	35	16	10
1/4	35	18	10
5/16	35	20	10
3/8	35	26	10
7/16	35	28	10
1/2	35	38	10

183H.35 (mm)	L (mm)	(g)	(pcs.)
3	35	15	10
4	35	15	10
5	35	15	10
6	35	18	10
7	35	19	10
8	35	20	10
10	35	26	10
11	35	28	10
12	35	30	10
14	35	35	10
16	35	47	10
17	35	50	10
18	35	53	10
19	35	56	10

183H.75 (mm)	L (mm)	R (mm)	(g)	(pcs.)
3	75	6	34	10
4	75	6	35	10
5	75	6.5	36	10
6	75	7.5	39	10
7	75	8.5	44	10
8	75	9.5	47	10
10	75	-	57	10
11	75	-	60	10
12	75	-	65	10
14	75	-	79	10

183H.150 (mm)	L (mm)	R (mm)	(g)	(pcs.)
4	150	6	51	10
5	150	6.5	55	10
6	150	7.5	65	10
8	150	9.5	87	10
10	150	-	118	10
12	150	-	136	10

183T-35 · -75 · -150 (T)

TORX® Bits
Puntas TORX®

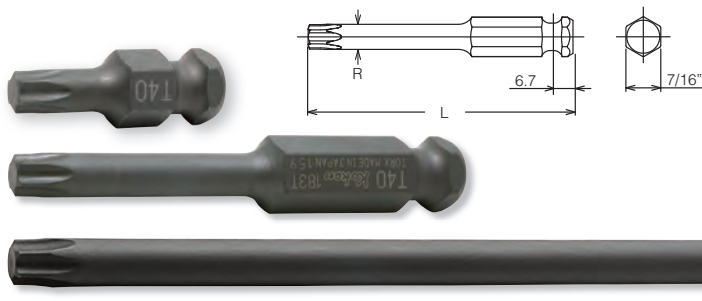

183T.35 (T)	L (mm)	(g)	(pcs.)
T25	35	18	10
T30	35	18	10
T40	35	20	10
T45	35	22	10
T50	35	26	10
T55	35	30	10
T60	35	38	10

183T.150 (T)	L (mm)	R (mm)	(g)	(pcs.)
T30	150	6	50	10
T40	150	6.9	58	10
T45	150	8	70	10
T50	150	9	82	10
T55	150	11.4	113	10

183T.75 (T)	L (mm)	R (mm)	(g)	(pcs.)
T30	75	6	35	10
T40	75	6.9	37	10
T45	75	8	41	10
T50	75	9	45	10
T55	75	11.4	55	10
T60	75	13.5	67	10

183T-35 · -75 (IP)

TORXPLUS® Bits
Puntas TORXPLUS®

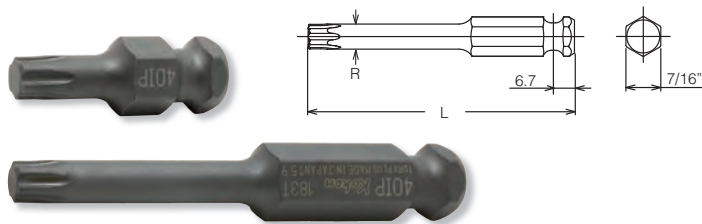

183T.35 (IP)	L (mm)	(g)	(pcs.)
30IP	35	18	10
40IP	35	20	10
45IP	35	22	10
50IP	35	26	10
55IP	35	30	10
60IP	35	38	10

183T.75 (IP)	L (mm)	R (mm)	(g)	(pcs.)
30IP	75	6	35	10
40IP	75	6.8	37	10
45IP	75	8	41	10
50IP	75	9	45	10
55IP	75	11.4	56	10
60IP	75	13.5	67	10

TORX is a registered trademark of Acument Intellectual Properties, LLC.
TORX es una marca registrada de Acument Intellectual Properties, LLC.
TORXplus is a registered trademark of Acument Intellectual Properties, LLC.
TORXplus es una marca registrada de Acument Intellectual Properties, LLC.

3/8", 1/2"

Sleeve Drive Sockets

183X.35 (XZN)	L (mm)	(g)	(pcs.)
M 4	35	18	10
M 5	35	18	10
M 6	35	20	10
M 8	35	22	10
M10	35	26	10
M12	35	30	10
M14	35	38	10

183X-35 · -75 · -150 (XZN)

XZN Bits
Puntas XZN

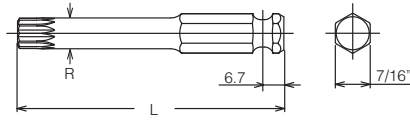

183X.75 (XZN)	L (mm)	R (mm)	(g)	(pcs.)
M 4	75	6	34	10
M 5	75	6	34	10
M 6	75	6.2	36	10
M 8	75	7.4	39	10
M10	75	9.8	54	10
M12	75	11.7	57	10
M14	75	13.5	67	10

183X.150 (XZN)	L (mm)	R (mm)	(g)	(pcs.)
M 5	150	6	50	10
M 6	150	6.2	53	10
M 8	150	7.4	64	10
M10	150	9.8	93	10
M12	150	11.7	121	10

	D ₁ (mm)	D ₂ (mm)	H (mm)	L (mm)	(g)	(pcs.)	
NV13134	22.5	22	15	45	100	5	*2

*2 C-Ring=1302C, Pin/O-Ring=1302A/B → P254-255

For
DIN3126 / ISO1173 E11.2 Bits

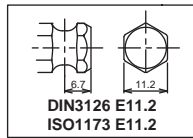

DIN3126 E11.2
ISO1173 E11.2



Replacement Screw : M8x5, ● 4mm

NV13134 Bit Holder Porta Punta

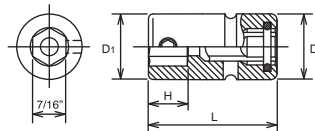

	D ₁ (mm)	D ₂ (mm)	H (mm)	L (mm)	(g)	(pcs.)	
NV14134	22.5	25	15	55	130	5	*1

*1 C-Ring=1401C, Pin/O-Ring=1401A/B → P254-255

For
DIN3126 / ISO1173 E11.2 Bits

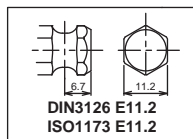

DIN3126 E11.2
ISO1173 E11.2



Replacement Screw : M8x5, ● 4mm

NV14134 Bit Holder Porta Punta

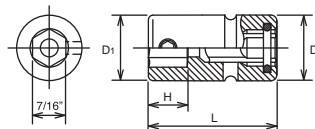

Z-SERIES
HAND
MANUALES
TITANIUM
DE TITANIO
ACCESSORIES
ACCESORIOS
DESTORNILLADORES
SCREWDRIVERS
DE IMPACTO
IMPACT
SLEEVE-DRIVE
INDUSTRIAL
INDUSTRIALES
PROTECTOR
PROTECTORES
AUTOMOTIVE
CONSTRUCTION
CONSTRUCCION
RENEWAL KITS
JUEGOS DE REPARACION

Sleeve Drive Sockets 1/2"

Z-SERIES
HAND MANUALES
TITANIUM DE TITANIO
ACCESSORIES ACCESORIOS
SCREWDRIVERS DESTORNILLADORES
IMPACT DE IMPACTO
SLEEVE-DRIVE
INDUSTRIAL INDUSTRIALES
PROTECTOR PROTECTORES
AUTOMOTIVE
CONSTRUCTION CONSTRUCCIÓN
RENEWAL KITS JUEGOS DE PIEZAS REPUESTO

NV14400 6-point Sockets Vasos Hexagonales

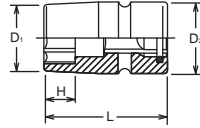

NV14400 (mm)	D ₁ (mm)	D ₂ (mm)	H (mm)	L (mm)	(g)	(pcs.)	
10	17	25	7	52	120	10	*1
12	19.5	25	9	54	120	10	*1
13	20.7	25	10	54	120	10	*1
14	22	25	10	54	120	10	*1
15	23.2	30	11	54	188	10	*2
16	24.5	30	11	54	189	10	*2
17	25.7	30	12	54	190	10	*2
18	27	30	12	54	190	10	*2
19	28.2	30	12	54	190	10	*2
21	30.7	30	12	54	191	10	*2
22	32	30	12	54	192	10	*2
23	33.2	30	12	54	196	10	*2
24	34.5	30	12	54	200	10	*2

*1 C-Ring=1401C, Pin/O-Ring=1401A/B → P254-255
*2 C-Ring=1402C, Pin/O-Ring=1402A/B

NV14145-100 • -150 • -200 Extended Sockets Vasos con Alargadera

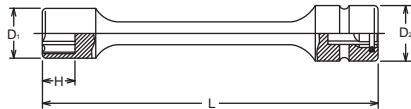

NV14145.100 (mm)	D ₁ (mm)	D ₂ (mm)	H (mm)	L (mm)	(g)	(pcs.)	
10	15.5	25	10	100	161	1	*1
12	18	25	12	100	178	1	*1
13	19	25	13	100	175	1	*1
14	21	25	14	100	181	1	*1
15	22	25	15	100	185	1	*1
16	24	25	15	100	193	1	*1
17	25	25	15	100	201	1	*1
18	26	25	15	100	211	1	*1
19	28	25	15	100	221	1	*1

NV14145.150 (mm)	D ₁ (mm)	D ₂ (mm)	H (mm)	L (mm)	(g)	(pcs.)	
10	15.5	25	10	150	200	1	*1
12	18	25	12	150	215	1	*1
13	19	25	13	150	220	1	*1
14	21	25	14	150	225	1	*1
15	22	25	15	150	230	1	*1
16	24	25	15	150	240	1	*1
17	25	25	15	150	250	1	*1
18	26	25	15	150	262	1	*1
19	28	25	15	150	275	1	*1

NV14145.200 (mm)	D ₁ (mm)	D ₂ (mm)	H (mm)	L (mm)	(g)	(pcs.)	
10	15.5	25	10	200	236	1	*1
12	18	25	12	200	250	1	*1
13	19	25	13	200	260	1	*1
14	21	25	14	200	270	1	*1
15	22	25	15	200	275	1	*1
16	24	25	15	200	287	1	*1
17	25	25	15	200	300	1	*1
18	26	25	15	200	310	1	*1
19	28	25	15	200	320	1	*1

*1 C-Ring=1401C, Pin/O-Ring=1401A/B → P254-255

NV14760 Extension Bars Alargaderas

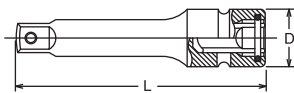

NV14760	TYPE	D (mm)	L (mm)	(g)	(pcs.)	
75	Hole	25	75	149	10	*1
125	Hole	25	125	230	10	*1
175	Hole	25	175	308	10	*1
250	Hole	25	250	422	10	*1

NV14760	TYPE	D (mm)	L (mm)	(g)	(pcs.)	
75P	Pin	25	75	149	10	*1
125P	Pin	25	125	230	10	*1
175P	Pin	25	175	308	10	*1
250P	Pin	25	250	422	10	*1

*1 C-Ring=1401C, Pin/O-Ring=1401A/B → P254-255

NV14433A-P Adaptors Adaptadores No Warranty Sin Garantía ⚠



NV14433A	(mm)	(mm)	L (mm)	(g)	(pcs.)	
75P	1/2"	3/8"	75	120	1	*1
100P	1/2"	3/8"	100	145	1	*1
150P	1/2"	3/8"	150	187	1	*1

*1 C-Ring=1401C, Pin/O-Ring=1401A/B → P254-255

⚠ Adapting down from bigger square drive to smaller square drive may lead to excessive torque load and possibly cause breakage. Always stay within safe torque of the smaller square drive.

3/4" Sleeve Drive Sockets

NV16400 (mm)	D ₁ (mm)	D ₂ (mm)	H (mm)	L (mm)	(g)	(pcs.)	⚡
17	30	44	12	65	448	5	*1
18	31.3	44	13	65	470	5	*1
19	32.5	44	13	65	455	5	*1
21	35	44	15	65	472	5	*1
22	36.3	44	16	65	471	5	*1
23	37.5	44	16	65	471	5	*1
24	38.8	44	16	65	467	5	*1
26	41.3	44	16	65	477	5	*1
27	42.5	44	16	65	473	5	*1
28	43.8	44	16	68	483	5	*1
29	45	44	18	68	464	5	*1
30	46.3	44	18	68	492	5	*1
32	48.8	44	19	70	514	5	*1
33	50	44	20	70	564	5	*1
34	51.3	44	20	70	588	5	*1
35	52.5	44	20	70	593	5	*1
36	53.8	44	20	70	598	5	*1
38	56.3	44	20	72	670	2	*1
41	60	44	22	72	687	2	*1
46	66.3	44	23	77	906	2	*1
50	69	44	23	77	1116	2	*1

*1 C-Ring=1600C, Pin/O-Ring=1601A/B → P254-255



NV16400 6-point Sockets Vasos Hexagonales

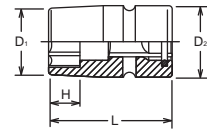

NV16760 Extension Bars Alargaderas

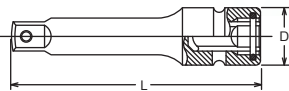

NV16760	D (mm)	L (mm)	(g)	(pce.)	⚡
175	44	175	870	1	*1
250	44	250	1160	1	*1
330	44	330	1460	1	*1

*1 C-Ring=1600C, Pin/O-Ring=1601A/B → P254-255

Z-SERIES
HAND
MANUALES
TITANIUM
DE TITANIO
ACCESSORIES
ACCESORIOS
SCREWDRIVERS
DESTORNILLADORES
IMPACT
DE IMPACTO
SLEEVE-DRIVE
INDUSTRIAL
INDUSTRIALES
PROTECTOR
PROTECTORES
AUTOMOTIVE
CONSTRUCTION
CONSTRUCCION
RENEWAL KITS
JUEGOS DE REPARACION

C-Ring Lock Clamps and Pullers

Aro de Sujeción en C y Extractor

Z-SERIES
HAND MANUALES
TITANIUM DE TITANIO
ACCESSORIES ACCESORIOS
IMPACT DE IMPACTO
SLEEVE-DRIVE
INDUSTRIAL INDUSTRIALES
PROTECTOR PROTECTORES
AUTOMOTIVE
CONSTRUCTION CONSTRUCCIÓN
RENEWAL KITS JUEGOS DE PIEZAS REPUÉS

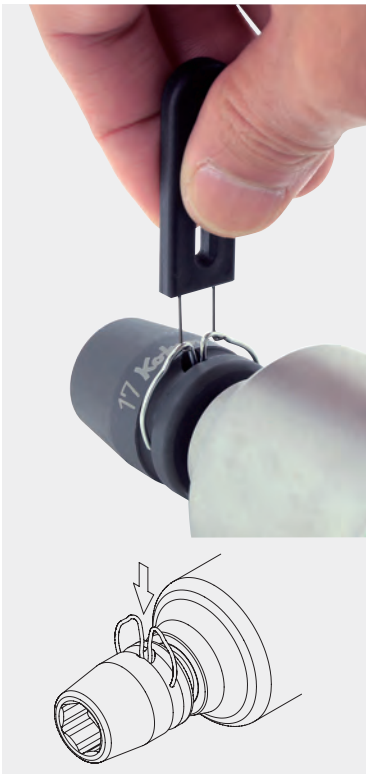

One Piece solid springs steel ring. Simply set by finger pushing and easily removed by puller. Much more convenient and safer than combination of pin and o-ring.

Aro de acero elástico de una pieza. Colocación sencilla apretando con el dedo y fácilmente extraíble con el extractor. Mucho más cómodo y seguro que la combinación de pasador y junta tórica.



C-RING



C-Ring

No.	□	Opening (mm)	📦 (pcs.)
1301C	3/8"	≤ 12	100
1302C	3/8"	> 12	100
1401C	1/2"	≤ 14	100
1402C	1/2"	> 14	100
1600C	3/4"	≤ 46	100
1801C	1"	≤ 70	100
1802C	1"	> 70	50
1700C	1-1/2"	≤ 90	50

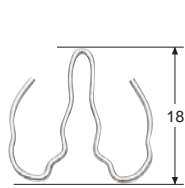

1301C

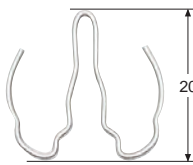

1302C

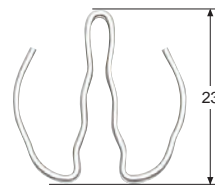

1401C

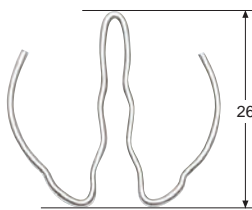

1402C

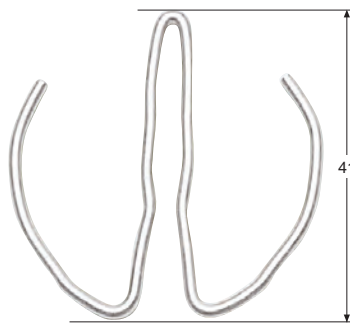

1600C

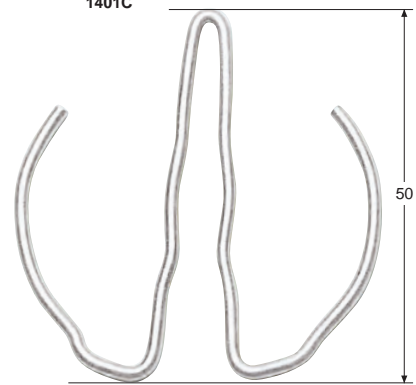

1801C

C-Ring Set

Set No.	□	C-Ring 10pcs.	Puller 1pce.
PK1301C	3/8"	1301C + 149	
PK1302C	3/8"	1302C + 149	
PK1401C	1/2"	1401C + 149	
PK1402C	1/2"	1402C + 149	
PK1600C	3/4"	1600C + 152	
PK1801C	1"	1801C + 152	

Puller

No.	□	□	📦 (pcs.)
149	3/8"	1/2"	10
152	3/4"	1"	10



149



152

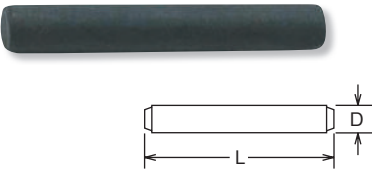

Pin

No.	□	Opening (mm)	D (mm)	L (mm)	pcs.)
1200A	1/4"		1.5	10.2	100
1301A	3/8"	≤ 12	2.5	14.5	100
1302A	3/8"	> 12	2.5	17.5	100
1401A	1/2"	≤ 14	3.5	20	100
1402A	1/2"	> 14	3.5	25	100
1500A	5/8"		4	29	100
1601A	3/4"	≤ 46	5.5	35	100
1602A	3/4"	> 46	5.5	45	100
1801A	1"	≤ 70	6	45	100
1802A	1"	> 70	6	75	50
1701A	1-1/2"	≤ 90	7	75	50
1702A	1-1/2"	> 90	7	110	50
1901A	2-1/2"	≤ 115	9	110	50
1902A	2-1/2"	> 115	9	155	50
2001A	3-1/2"	≤ 140	13	155	1
2002A	3-1/2"	> 140	13	180	1

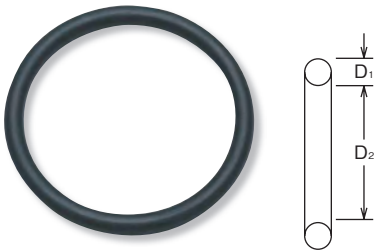

O-Ring

No.	□	Opening (mm)	D ₁ (mm)	D ₂ (mm)	pcs.)
1200B	1/4"		2.5	9	100
1301B	3/8"	≤ 12	3.5	13	100
1302B	3/8"	> 12	3.5	16	100
1401B	1/2"	≤ 14	4	19	100
1402B	1/2"	> 14	4	24	100
1500B	5/8"		5	28	100
1601B	3/4"	≤ 46	5	36	100
1602B	3/4"	> 46	5	45	100
1801B	1"	≤ 70	7	45	100
1802B	1"	> 70	7	75	50
1701B	1-1/2"	≤ 90	10	75	50
1702B	1-1/2"	> 90	10	114	50
1901B	2-1/2"	≤ 115	10.5	114	50
1902B	2-1/2"	> 115	10.5	158	50
2001B	3-1/2"	≤ 140	15	158	1
2002B	3-1/2"	> 140	15	183	1



Pins & O Rings/C-Ring Lock Clamps

Pasadores y Juntas Tóricas/Aros de Sujeción en C

IMPACT Standard Sockets	Sq. Dr.	1/4"	3/8"		1/2"		3/4"		1"		1-1/2"		
		C-Ring	1301C	1302C	1401C	1402C	1600C	1801C	1801C	1802C	1700C		
		O-Ring/Pin	1200A/B	1301A/B	1302A/B	1401A/B	1402A/B	1601A/B	1602A/B	1801A/B	1802A/B	1701A/B	1702A/B
4		●											
4.5	3/16	●											
5		●											
5.5		●											
6	1/4	●	●			●							
7	9/32	●	●			●							
8	5/16	●	●			●							
9	11/32	●	●			●							
10	3/8	●	●			●							
11	7/16	●	●			●							
12		●	●			●							
13	1/2	●		●		●							
14	9/16	●		●		●		●					
15				●		●		●					
16	5/8			●		●		●		●			
17	11/16			●		●		●		●			
18				●		●		●		●			
19	3/4			●		●		●		●			
20				●		●		●		●			
21	13/16			●		●		●		●			
22	7/8			●		●		●		●			
23				●		●		●		●			
24	15/16			●		●		●		●			
25	1					●		●		●			
26						●		●		●			
27	1- 1/16					●		●		●			
28						●		●		●			
29	1- 1/8					●		●		●			
30	1- 3/16					●		●		●			
31						●		●		●			
32	1- 1/4					●		●		●			
33	1- 5/16					●		●		●			
34	1- 3/8					●		●		●			
36						●		●		●		●	
37	1- 7/16					●		●		●		●	
38	1- 1/2					●		●		●		●	
39						●		●		●		●	
40	1- 9/16					●		●		●		●	
41	1- 5/8					●		●		●		●	
42						●		●		●		●	
43	1- 11/16					●		●		●		●	
44						●		●		●		●	
45	1- 3/4					●		●		●		●	
46	1- 13/16					●		●		●		●	
47						●		●		●		●	
48	1- 7/8					●		●		●		●	
	1- 15/16					●		●		●		●	
50						●		●		●		●	
	2					●		●		●		●	
52	2- 1/16					●		●		●		●	
54	2- 1/8					●		●		●		●	
55	2- 3/16					●		●		●		●	
56						●		●		●		●	
	2- 1/4					●		●		●		●	
58	2- 5/16					●		●		●		●	
60	2- 3/8					●		●		●		●	
62	2- 7/16					●		●		●		●	
63						●		●		●		●	
	2- 1/2					●		●		●		●	
65	2- 9/16					●		●		●		●	
67	2- 5/8					●		●		●		●	
68	2- 11/16					●		●		●		●	
70	2- 3/4					●		●		●		●	
	2- 13/16					●		●		●		●	
	2- 7/8					●		●		●		●	
75	2- 15/16					●		●		●		●	
	3					●		●		●		●	
	3- 1/16					●		●		●		●	
80	3- 1/8					●		●		●		●	
	3- 1/4					●		●		●		●	
85						●		●		●		●	
	3- 3/8					●		●		●		●	
90	3- 1/2					●		●		●		●	
	3- 5/8					●		●		●		●	
95	3- 3/4					●		●		●		●	
100	3- 7/8					●		●		●		●	
105	4					●		●		●		●	
	4- 1/8					●		●		●		●	
110	4- 1/4					●		●		●		●	
115	4- 1/2					●		●		●		●	
120	4- 5/8					●		●		●		●	
	4- 3/4					●		●		●		●	
125	4- 7/8					●		●		●		●	
130	5					●		●		●		●	
135	5- 1/4					●		●		●		●	
140						●		●		●		●	
150						●		●		●		●	
	6					●		●		●		●	
	6- 1/2					●		●		●		●	

Industrial Sockets

1/4"

3/8"

1/2"



Industrial Sockets 1/4"

Z-SERIES
HAND MANUALES
TITANIUM DE TITANIO
ACCESSORIES ACCESORIOS
SCREWDRIVERS DESTORNILLADORES
IMPACT DE IMPACTO
SLEEVE-DRIVE
INDUSTRIAL INDUSTRIALES
PROTECTOR PROTECTORES
AUTOMOTIVE
CONSTRUCTION CONSTRUCCIÓN
RENEWAL KITS JUEGOS DE PIEZAS/REPUESTO

22400M 6-point Sockets Vasos Hexagonales

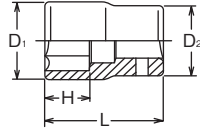

22400M (mm)	D ₁ (mm)	D ₂ (mm)	H (mm)	L (mm)	(g)	(pcs.)
6	9.2	11.2	5.5	22	9	10
7	10.3	11.2	6	22	9	10
8	11.2	11.7	6.9	22	11	10
10	14.3	12.9	7.7	22	15	10
12	16.8	15.5	9.3	22	23	10
13	18	16.4	9.8	22	23	10

22425 TORX® Sockets Vasos TORX®

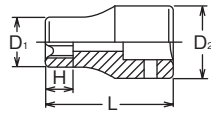

22425 (E)	D ₁ (mm)	D ₂ (mm)	H (mm)	L (mm)	(g)	(pcs.)
E 4	5.4	11.2	4.6	22	7	10
E 5	6.7	11.2	5.2	22	8	10
E 6	7.7	11.2	5.4	22	8	10
E 7	8.3	11.2	6.6	22	9	10
E 8	9.6	11.2	7	22	9	10
E10	11.3	12	8.2	22	10	10

TORX® (E)

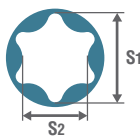

E	E4	E5	E6	E7	E8	E10	E11	E12	E14	E16	E18	E20	E22	E24	E26	E28	E30	E32
S ₁ (ref. mm)	3.7	4.6	5.6	6.1	7.4	9.3	9.9	11.0	12.8	14.6	16.5	18.3	20.1	22.0	23.7	25.5	27.3	29.0
S ₂ (ref. mm)	2.7	3.3	4.0	4.3	5.3	6.8	7.1	7.9	9.2	10.5	11.9	13.2	14.8	15.7	17.5	18.3	20.0	21.3

22300M • 22300A 6-point Sockets, Deep Vasos Hexagonales, largos

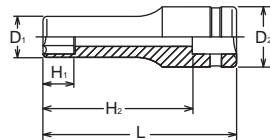

22300M (mm)	D ₁ (mm)	D ₂ (mm)	H ₁ (mm)	H ₂ (mm)	L (mm)	(g)	(pcs.)
7	10.5	11.2	8	40	50	24	10
8	11.8	11.2	9	40	50	28	10
10	14.3	12.9	11	39	50	33	10
12	16.8	15.5	13	39	50	50	10
13	18	16.4	14	39	50	50	10

22300A (inch)	D ₁ (mm)	D ₂ (mm)	H ₁ (mm)	H ₂ (mm)	L (mm)	(g)	(pcs.)
1/4	9.8	11.2	7	40	50	24	10
5/16	11.8	11.2	9	40	50	28	10
3/8	13.7	12.5	11	40	50	33	10



INDUSTRIAL sockets are thin walled sockets and to be used on electric or pneumatic nut runners for assembly work only.

Los vasos INDUSTRIALES son vasos de pared delgada para su utilización con herramientas eléctricas o neumáticas solamente para trabajos de montaje.

23400M (mm)	D ₁ (mm)	D ₂ (mm)	H (mm)	L (mm)	(g)	(pcs.)
6	9.9	17.3	6	26	20	10
7	10.8	17.3	6.5	26	20	10
8	12	17.3	6.9	26	22	10
10	14.5	17.3	8	26	24	10
11	15.8	17.3	9.3	26	25	10
12	16.8	17.3	9	26	25	10
13	18	17	9.4	26	24	10
14	19.5	18.5	11	27	31	10
15	21	19.5	11.5	28	39	10
16	22	20	12	28	42	10
17	23.5	21.5	12.5	29	51	10
18	24.6	22.5	13	30	51	10
19	26	23.5	13.5	30	53	10
21	28	26	14.5	32	77	10

23400A (inch)	D ₁ (mm)	D ₂ (mm)	H (mm)	L (mm)	(g)	(pcs.)
5/16	12	17.3	6.9	26	22	10
3/8	13.9	17.3	8	26	22	10
7/16	15.8	17.3	9.3	26	25	10
1/2	18	17	9.4	26	24	10
9/16	19.5	18.5	11	27	31	10
11/16	24.6	22.5	13	30	51	10
3/4	26	23.5	13.5	30	63	10

23405M (mm)	D ₁ (mm)	D ₂ (mm)	H (mm)	L (mm)	(g)	(pcs.)
8	12	17.3	6.9	26	22	10
10	14.5	17.3	8	26	24	10
12	16.8	17.3	9	26	25	10
14	19.5	18.5	11	27	31	10

23410M (mm)	D ₁ (mm)	D ₂ (mm)	H (mm)	L (mm)	(g)	(pcs.)
8	12	17.3	6.9	26	22	10
10	14.5	17.3	8	26	24	10
12	16.8	17.3	9	26	25	10
13	18	17	9.4	26	24	10
14	19.5	18.5	11	27	31	10
15	21	19.5	11.5	28	39	10
16	22	20	12	28	42	10
17	23.5	21.5	12.5	29	51	10
18	24.6	22.5	13	30	51	10
19	26	23.5	13.5	30	53	10

23425 (E)	D ₁ (mm)	D ₂ (mm)	H (mm)	L (mm)	(g)	(pcs.)
E 5	7	17.3	5.2	26	20	10
E 6	8.3	17.3	5.4	26	21	10
E 7	8.9	17.3	6.6	26	22	10
E 8	9.9	17.3	7	26	23	10
E10	12	17.3	8.2	26	24	10
E12	14.5	17.3	9.3	26	26	10
E14	15.8	17.3	10.6	26	27	10
E16	18.1	17	11.8	26	27	10

TORX® (E)

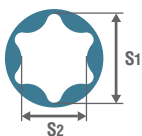

E	E4	E5	E6	E7	E8	E10	E11	E12	E14	E16	E18	E20	E22	E24	E26	E28	E30	E32
S ₁ (ref. mm)	3.7	4.6	5.6	6.1	7.4	9.3	9.9	11.0	12.8	14.6	16.5	18.3	20.1	22.0	23.7	25.5	27.3	29.0
S ₂ (ref. mm)	2.7	3.3	4.0	4.3	5.3	6.8	7.1	7.9	9.2	10.5	11.9	13.2	14.8	15.7	17.5	18.3	20.0	21.3



23400M • 23400A 6-point Sockets Vasos Hexagonales

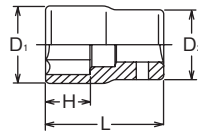

23405M 12-point Sockets Vasos Bihexagonales

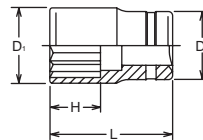

23410M Surface Drive Sockets Vasos Surface Drive (de Contacto Curvo)

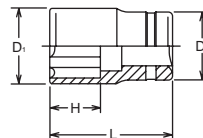

23425 TORX® Sockets Vasos TORX®

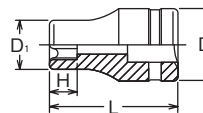

Z-SERIES
HAND
MANUALES
TITANIUM
DE TITANIO
ACCESSORIES
ACCESORIOS
SCREWDRIEVERS
DESTORNILLADORES
IMPACT
DE IMPACTO
SLEEVE-DRIVE
INDUSTRIAL
INDUSTRIALES
PROTECTOR
PROTECTORES
AUTOMOTIVE
CONSTRUCTION
CONSTRUCCION
RENEWAL KITS
JUEGOS DE REPARACION

Z-SERIES
HAND MANUALES
TITANIUM DE TITANIO
ACCESSORIES ACCESORIOS
SCREWDRIVERS DESTORNILLADORES
IMPACT DE IMPACTO
SLEEVE-DRIVE
INDUSTRIAL INDUSTRIALES
PROTECTOR PROTECTORES
AUTOMOTIVE
CONSTRUCTION CONSTRUCCIÓN
RENEWAL KITS JUEGOS DE PIEZAS REPUESTO

23300M • 23300A 6-point Sockets, Deep Vasos Hexagonales, largos

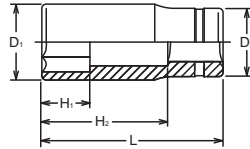

23300M (mm)	D ₁ (mm)	D ₂ (mm)	H ₁ (mm)	H ₂ (mm)	L (mm)	(g)	(pcs.)
7	10.6	17.4	8	41.5	55	40	10
8	12	17.4	9	41.5	55	45	10
10	14.5	17.4	11	41.5	55	52	10
11	16	17.2	12	41.5	55	55	10
12	16.8	17.2	13	41.5	55	58	10
13	18	17	14	41.5	55	57	10
14	20	18	16	41.5	55	68	10
15	21	20	16	40.5	55	78	10
16	22	20	17	40.5	55	79	10
17	23.5	22	18	40.5	55	96	10
18	24.5	23	19	39.5	55	96	10
19	25	24	20	39.5	55	102	10

23300A (inch)	D ₁ (mm)	D ₂ (mm)	H ₁ (mm)	H ₂ (mm)	L (mm)	(g)	(pcs.)
5/16	12	17.4	9	41.5	55	45	10
3/8	14	17.4	11	41.5	55	51	10
7/16	16	17.2	12	41.5	55	55	10
1/2	18	17	14	41.5	55	57	10
9/16	20	18	16	41.5	55	68	10
11/16	23.5	22	18	40.5	55	96	10
3/4	25	24	20	39.5	55	102	10

23305M 12-point Deep Sockets Vasos Bihexagonales Largos

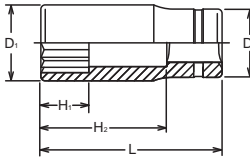

23305M (mm)	D ₁ (mm)	D ₂ (mm)	H ₁ (mm)	H ₂ (mm)	L (mm)	(g)	(pcs.)
8	12	17.4	9	41.5	55	45	10
10	14.5	17.4	11	41.5	55	52	10
12	16.8	17.2	13	41.5	55	58	10
14	20	18	16	41.5	55	68	10

23310M Surface Drive Sockets, Deep Vasos Surface Drive (de Contacto Curvo) Largos

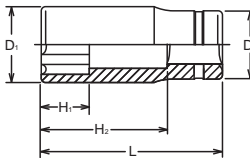

23310M (mm)	D ₁ (mm)	D ₂ (mm)	H ₁ (mm)	H ₂ (mm)	L (mm)	(g)	(pcs.)
8	12	17.4	9	41.5	55	45	10
10	14.5	17.4	11	41.5	55	52	10
12	16.8	17.2	13	41.5	55	58	10
13	18	17	14	41.5	55	57	10
14	20	18	16	41.5	55	68	10
15	21	20	16	40.5	55	80	10
17	23.5	22	18	40.5	55	96	10

23325 TORX® Deep Sockets Vasos TORX®, largos

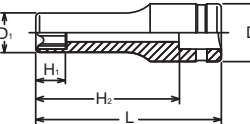

23325 (E)	D ₁ (mm)	D ₂ (mm)	H ₁ (mm)	H ₂ (mm)	L (mm)	(g)	(pcs.)
E 5	6.9	17.4	5.2	41.5	55	50	10
E 6	7.9	17.4	5.4	41.5	55	52	10
E 7	8.9	17.4	6.6	41.5	55	55	10
E 8	9.9	17.4	7	41.5	55	58	10
E10	11.8	17.2	8.2	41.5	55	60	10
E12	14.5	17.2	9.3	41.5	55	68	10
E14	15.7	17.2	10.6	41.5	55	77	10
E16	18	17	11.8	41.5	55	80	10

23760-P Extension Bars Alargaderas

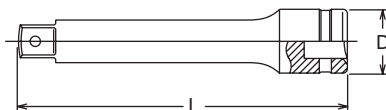

23760	D (mm)	L (mm)	(g)	(pcs.)
75P	18	75	70	10
125P	18	125	110	10
250P	18	250	200	5

24400M (mm)	D ₁ (mm)	D ₂ (mm)	H (mm)	L (mm)	(g)	(pcs.)
10	15.3	21	9	37	45	10
11	16.5	21	9.5	37	46	10
12	17.8	21	10	37	47	10
13	19	22	10.5	37	53	10
14	20.3	22	11	37	56	10
15	21.5	22	11.5	37	52	10
16	22.8	22	12	37	62	10
17	24.1	23	12.5	37	69	10
18	25.1	24	13	37	74	10
19	26.6	25	14	38	89	10
20	27.9	26	15	38	92	10
21	29.1	27	15.5	38	102	10
22	30.1	28	16	40	113	10
23	31.5	29	16.5	40	128	10
24	32.9	30	17	42	140	5
26	35	32	19	42	165	5
27	36.5	33	19.5	43	196	5
29	39	35	20.5	43	190	5
30	40	36	22	46	222	5
32	42.8	38	23	46	250	5

24400A (inch)	D ₁ (mm)	D ₂ (mm)	H (mm)	L (mm)	(g)	(pcs.)
7/16	16.5	21	9.5	37	46	10
1/2	19	22	10.5	37	53	10
9/16	20.3	22	11	37	56	10
5/8	22.9	22	12	37	62	10
3/4	26.6	25	14	38	89	10
15/16	32.9	30	17	42	140	5

24405M (mm)	D ₁ (mm)	D ₂ (mm)	H (mm)	L (mm)	(g)	(pcs.)
10	15.3	21	9	37	45	10
12	17.8	21	10	37	47	10
14	20.3	22	11	37	56	10
17	24.1	23	12.5	37	69	10
19	26.6	25	14	38	89	10

24410M (mm)	D ₁ (mm)	D ₂ (mm)	H (mm)	L (mm)	(g)	(pcs.)
10	15.3	21	9	37	45	10
12	17.8	21	10	37	47	10
13	19	22	10.5	37	53	10
14	20.3	22	11	37	56	10
15	21.5	22	11.5	37	52	10
16	22.8	22	12	37	62	10
17	24.1	23	12.5	37	69	10
18	25.1	24	13	37	74	10
19	26.6	25	14	38	89	10
21	29.1	27	15.5	38	102	10
22	30.1	28	16	40	113	10
24	32.9	30	17	42	140	5

24425 (E)	D ₁ (mm)	D ₂ (mm)	H (mm)	L (mm)	(g)	(pcs.)
E10	13.2	21	8.2	36	68	10
E12	14.6	21	9.3	37	70	10
E14	16.5	21	10.6	37	75	10
E16	19	21.9	11.8	37	80	10
E18	20.3	21.9	13	37	83	10
E20	22.9	22	14.4	37	121	10

TORX® (E)

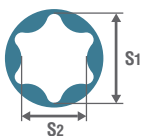

E	E4	E5	E6	E7	E8	E10	E11	E12	E14	E16	E18	E20	E22	E24	E26	E28	E30	E32
S ₁ (ref. mm)	3.7	4.6	5.6	6.1	7.4	9.3	9.9	11.0	12.8	14.6	16.5	18.3	20.1	22.0	23.7	25.5	27.3	29.0
S ₂ (ref. mm)	2.7	3.3	4.0	4.3	5.3	6.8	7.1	7.9	9.2	10.5	11.9	13.2	14.8	15.7	17.5	18.3	20.0	21.3



FLAT DRIVE®

24400M • 24400A 6-point Sockets Vasos Hexagonales

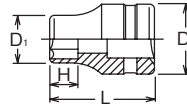

24405M 12-point Sockets Vasos Bihexagonales

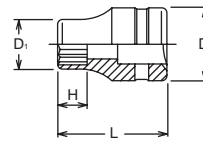

24410M Surface Drive Sockets Vasos Surface Drive (de Contacto Curvo)



SURFACE DRIVE

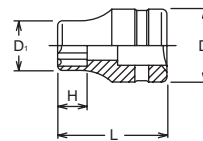

24425 TORX® Sockets Vasos TORX®

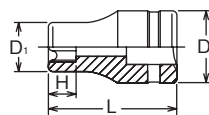

Z-SERIES
HAND MANUALES
TITANIUM DE TITANIO
ACCESSORIES ACCESORIOS
SCREWDRIVERS DESTORNILLADORES
IMPACT DE IMPACTO
SLEEVE-DRIVE
INDUSTRIAL INDUSTRIALES
PROTECTOR PROTECTORES
AUTOMOTIVE
CONSTRUCTION CONSTRUCCIÓN
RENEWAL KITS JUEGOS DE PIEZAS REPUESTO

24300M • 24300A ○ 6-point Sockets, Deep Vasos Hexagonales, largos

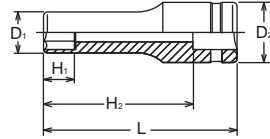
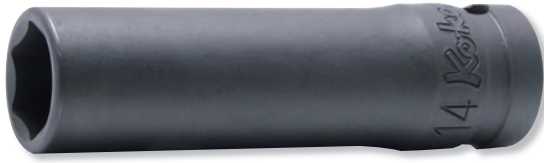

24300M (mm)	D ₁ (mm)	D ₂ (mm)	H ₁ (mm)	H ₂ (mm)	L (mm)	(g)	(pcs.)
10	15.3	21	11	59	77	91	10
11	16.5	21	12	59	77	95	10
12	17.8	21	13	59	77	99	10
13	19	21.8	14	59	77	107	10
14	20.3	21.8	16	59	77	118	10
15	21.5	21.8	16	59	77	123	10
16	22.8	22	17	59	77	141	10
17	24	23	18	59	77	150	10
18	25	24	19	59	77	164	10
19	26.5	25	20	58	77	177	10
20	27.8	26	21	58	77	178	10
21	29	27	23	58	77	187	10
22	30	28	27	57	77	202	10
24	32.8	30	27	57	77	252	10
27	36.5	33	28	56	77	303	10
30	40	36	34	55	77	342	10
32	42.8	38	34	55	77	405	10

24300A (inch)	D ₁ (mm)	D ₂ (mm)	H ₁ (mm)	H ₂ (mm)	L (mm)	(g)	(pcs.)
7/16	16.5	21	12	59	77	95	10
1/2	19	21.8	14	59	77	107	10
9/16	20.3	21.8	16	59	77	118	10
5/8	22.8	22	17	59	77	141	10
21/32	24	23	18	59	77	150	10
11/16	25	24	19	59	77	164	10
3/4	26.5	25	20	58	77	177	10
13/16	29	27	23	58	77	187	10
15/16	32.8	30	27	57	77	252	10

24305M ○ 12-point Deep Sockets Vasos Bihexagonales Largos

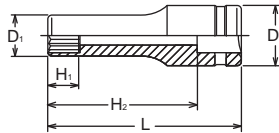

24305M (mm)	D ₁ (mm)	D ₂ (mm)	H ₁ (mm)	H ₂ (mm)	L (mm)	(g)	(pcs.)
10	15.3	21	11	59	77	91	10
12	17.8	21	13	59	77	99	10
14	20.3	21.8	16	59	77	118	10
17	24	23	18	59	77	150	10
19	26.5	25	20	58	77	177	10

24310M ○ Surface Drive Sockets, Deep Vasos Surface Drive (de Contacto Curvo) Largos

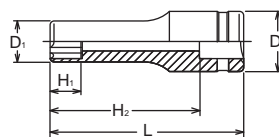

24310M (mm)	D ₁ (mm)	D ₂ (mm)	H ₁ (mm)	H ₂ (mm)	L (mm)	(g)	(pcs.)
10	15.3	21	11	59	77	91	10
12	17.8	21	13	59	77	99	10
13	19	21.8	14	59	77	107	10
14	20.3	21.8	16	59	77	118	10
15	21.5	21.8	16	59	77	123	10
16	22.8	22	17	59	77	141	10
17	24	23	18	59	77	150	10
18	25	24	19	59	77	160	10
19	26.5	25	20	58	77	177	10
21	29	27	23	58	77	187	10
22	30	28	27	57	77	202	10
24	32.8	30	27	57	77	250	10

24760-P Extension Bars Alargaderas

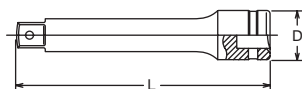

24760	D (mm)	L (mm)	(g)	(pcs.)
75P	24	75	140	10
125P	24	125	200	5
250P	24	250	370	5

3/8"

1/2"

Sockets with Turnable Plastic Protectors



Plastic Protector
Protectores Plásticos

Z-SERIES
HAND
MANUALES
TITANIUM
DE TITANIO
ACCESSORIES
ACCESORIOS
SCREWDRIVERS
DESTORNILLADORES
IMPACT
DE IMPACTO
SLEEVE-DRIVE
INDUSTRIAL
INDUSTRIALES
PROTECTOR
PROTECTORES
AUTOMOTIVE
CONSTRUCTION
CONSTRUCCIÓN
RENEWAL KITS
JUEGOS DE PIEZAS REPUESTO



Safety

Turnable plastic protector increases operator's safety during assembly process.



Scratch proof

Protector helps to reduce the possibility giving damage on painted, polished and sensitive surfaces. Protector is free rotation designed.

Protector series are make-to-order manufacturing

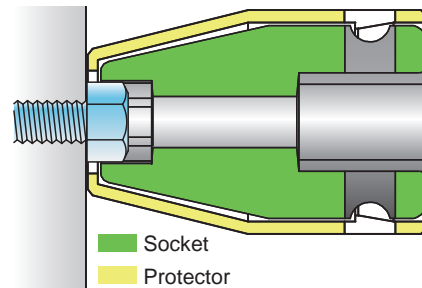

3/8" 1/2" Plastic Protector Protectores Plásticos

13400M (FR)	D ₁ (mm)	D ₂ (mm)	H (mm)	L (mm)	(g)
8FR	15.7	22	6	33.3	40
10FR	18.2	22	7	33.3	40
12FR	20.8	22	9	33.3	43
13FR	21.8	25	10	33.3	56
14FR	23.6	25	10	33.3	56
16FR	26.1	25	11	33.3	57
17FR	27.3	25	12	33.3	60



13400M-FR

6-point Sockets
Vasos Hexagonales

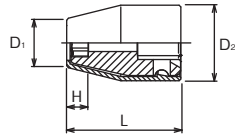

13760 (FR)	D (mm)	L (mm)	(g)
125P.FR	26.2	125	145
250P.FR	26.2	250	220

13760-P.FR

Extension Bars
Alargaderas

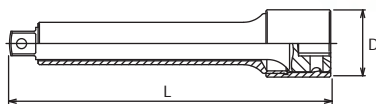

14400M (FR)	D ₁ (mm)	D ₂ (mm)	H (mm)	L (mm)	(g)
10FR	19.5	28	7	39.3	90
12FR	22	28	9	39.3	90
13FR	23.2	28	10	39.3	90
14FR	24.8	28	11	39.3	90
16FR	27	33	10	39.3	135
17FR	28.2	33	12	39.3	135
19FR	31	33	13	39.3	130

14400M-FR

6-point Sockets
Vasos Hexagonales

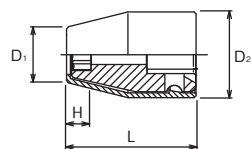

14760 (FR)	D (mm)	L (mm)	(g)
125P.FR	34.2	125	280
250P.FR	34.2	250	480

14760-P.FR

Extension Bars
Alargaderas

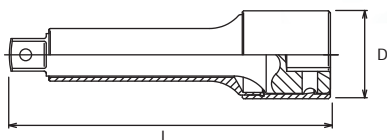

The protector could be broken with any impacts. Please handle with care.

Z-SERIES
HAND
MANUALES
TITANIUM
DE TITANIO
ACCESSORIES
ACCESORIOS
SCREWDRIVERS
DESTORNILLADORES
IMPACT
DE IMPACTO
SLEEVE-DRIVE
INDUSTRIAL
INDUSTRIALES
PROTECTOR
PROTECTORES
AUTOMOTIVE
CONSTRUCTION
CONSTRUCCION
RENEWAL KITS
JUEGOS DE REPARACION

115G-100FR • -150FR • -200FR



Nut Setters with Sliding Magnet
Vasos para tuercas con Imán Corredizo

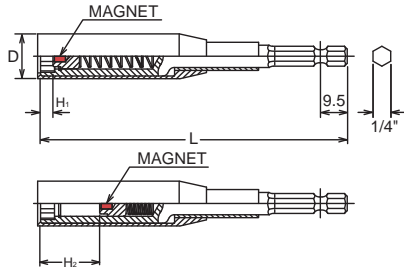

115G.100 (FR)	D (mm)	H ₁ (mm)	H ₂ (mm)	L (mm)	⚖️ (g)
8FR	15.1	4	26	100	55
10FR	16.9	4.5	26	100	60
12FR	19.3	6	26	100	80
13FR	20.4	6.5	25	100	85

115G.150 (FR)	D (mm)	H ₁ (mm)	H ₂ (mm)	L (mm)	⚖️ (g)
8FR	15.1	4	26	150	75
10FR	16.9	4.5	26	150	80
12FR	19.3	6	26	150	100
13FR	20.4	6.5	25	150	110

115G.200 (FR)	D (mm)	H ₁ (mm)	H ₂ (mm)	L (mm)	⚖️ (g)
8FR	15.1	4	26	200	90
10FR	16.9	4.5	26	200	100
12FR	19.3	6	26	200	125
13FR	20.4	6.5	25	200	135



The protector could be broken with any impacts. Please handle with care.

REPLACEMENT

Remove a damaged Protector and put a new Protector on Socket / Extension bar by pressing.
For your safety, worn out or cracked Protector must be replaced.



Specifications or design of any product in this catalogue are subject to change without notice.

Las especificaciones o el diseño de cualquiera de los productos de este catálogo están sujetos a cambio sin previo aviso.

Automotive Tools



Z-SERIES
HAND
MANUALES
TITANIUM
DE TITANIO
ACCESSORIES
ACCESORIOS
SCREWDRIVERS
DESTORNILLADORES
IMPACT
DE IMPACTO
SLEEVE-DRIVE
INDUSTRIAL
INDUSTRIALES
PROTECTOR
PROTECTORES
AUTOMOTIVE
CONSTRUCTION
RENEWAL KITS
JUEGOS DE PIEZAS
REPUËSTO
CONSTRUCCI3N

3300C · 4300C Spark Plug Sockets with Spring Clips
Llaves de Bujía con Presillas

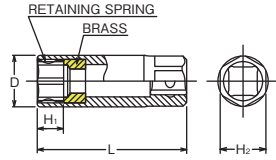

3300C (mm)		D (mm)	H ₁ (mm)	H ₂ (mm)	L (mm)	(g)	(pcs.)
13	3/8"	17.5	11	17	70	66	10
14		19	11	17	70	82	10
16		20.5	13	17	70	91	10
18		23.9	12	21	70	140	10
20.8		26.9	13.5	22	70	132	10

4300C (mm)		D (mm)	H ₁ (mm)	H ₂ (mm)	L (mm)	(g)	(pcs.)
16	1/2"	21	13	21	70	101	10
18		23.9	12	21	70	132	10
20.8		26.9	13.5	22	70	130	10

Spring clip type spark plug sockets caused deforming the clip if it would be used with shallow engagement.

3300CB Spark Plug Socket (BMW)
Llave de Bujía (BMW)

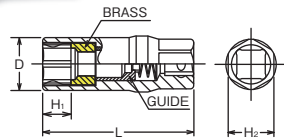

3300CB (mm)		D (mm)	H ₁ (mm)	H ₂ (mm)	L (mm)	(g)	(pcs.)
16	3/8"	22.8	13	19	65	118	10

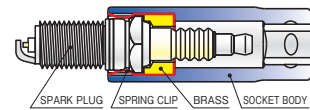

SPARK PLUG SOCKETS with SPRING CLIP

An internal brass guide holds the clips in place, which ensures perfect alignment of the spark plug into the threaded plug hole of the cylinder head, thus preventing thread damage. The brass guide also eliminates stress loading and possible damage to the ceramic insulator of the spark plug.

Spring clip type spark plug sockets caused deforming the clip if it would be used with shallow engagement.

3305P Spark Plug Socket with Magnet, 12-point Opening
Llaves de bujía con Imán, Boca Bihex

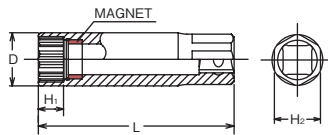

3305P (mm)		D (mm)	H ₁ (mm)	H ₂ (mm)	L (mm)	(g)	(pcs.)
14	3/8"	19	8	17	70	87	10
16		20.5	8	17	70	100	10

Spark Plug Socket with Magnet, 12-pt. opening: 3305P-14



The magnet could be broken with any impacts. Please handle with care.

3300S · 4300S Spark Plug Sockets with Rubber
Llaves de bujía con Goma

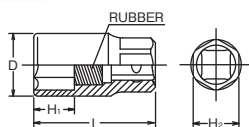

3300S (mm)		D (mm)	H ₁ (mm)	H ₂ (mm)	L (mm)	(g)	(pcs.)
16	3/8"	20.9	19	17	70	100	10
18		23.9	21	21	70	145	10
20.8		26.9	27	22	70	140	10

4300S (mm)		D (mm)	H ₁ (mm)	H ₂ (mm)	L (mm)	(g)	(pcs.)
16	1/2"	21	19	21	70	100	10
18		23.9	21	21	70	130	10
20.8		26.9	27	22	70	135	10

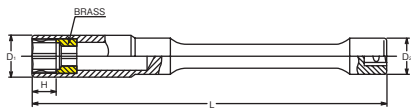

SPARK PLUG SOCKET

3300C.180 (mm)		D ₁ (mm)	D ₂ (mm)	H (mm)	L (mm)	(g)	(pcs.)
14	3/8"	19	18	11	180	205	5
16		20.5	18	13	180	220	5
20.8		26.9	18	13.5	180	260	5

3300C.250 (mm)		D ₁ (mm)	D ₂ (mm)	H (mm)	L (mm)	(g)	(pcs.)
14	3/8"	19	18	11	250	271	5
16		20.5	18	13	250	290	5
20.8		26.9	18	13.5	250	340	5

⚠ Spring clip type spark plug sockets caused deforming the clip if it would be used with shallow engagement.

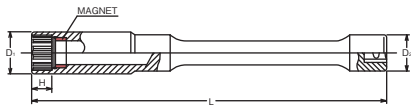

3305P-250 ○ Spark Plug Socket with Magnet, 12-point Opening
Llave de bujía con Imán, Boca Bihex ⚠

3305P.250 (mm)		D ₁ (mm)	D ₂ (mm)	H (mm)	L (mm)	(g)	(pcs.)
14	3/8"	19	18	8	250	250	5

⚠ The magnet could be broken with any impacts. Please handle with care.

3340C (mm)		D ₁ (mm)	D ₂ (mm)	H (mm)	L (mm)	(g)	(pcs.)
14	3/8"	19	19	11	88	109	10
16		21	19	13	88	122	10
18		23.9	19	12	88	145	10
20.8		26.8	19	13.5	88	174	10

4340C (mm)		D ₁ (mm)	D ₂ (mm)	H (mm)	L (mm)	(g)	(pcs.)
16	1/2"	21	25	13	100	220	10
20.8		26.8	25	13.5	100	250	10

⚠ Spring clip type spark plug sockets caused deforming the clip if it would be used with shallow engagement.

3345P (mm)		D ₁ (mm)	D ₂ (mm)	H (mm)	L (mm)	(g)	(pcs.)
14	3/8"	19	19	8	88	110	10

⚠ The magnet could be broken with any impacts. Please handle with care.



SPARK PLUG SOCKET

3340C · 4340C ○ Universal Spark Plug Sockets with Spring Clips
Llaves de bujía con Presillas con Articulación Universal ⚠

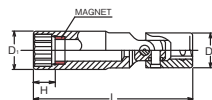
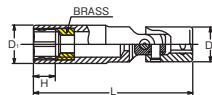

3345P ○ Universal Spark Plug Socket with Magnet, 12-point opening
Llave de bujía con Imán con Articulación Universal, Boca Bihex ⚠



SPARK PLUG SOCKET

127C ○ T-type Universal Spark Plug Socket Wrench
Llave de Bujías en T con Articulación Universal ⚠

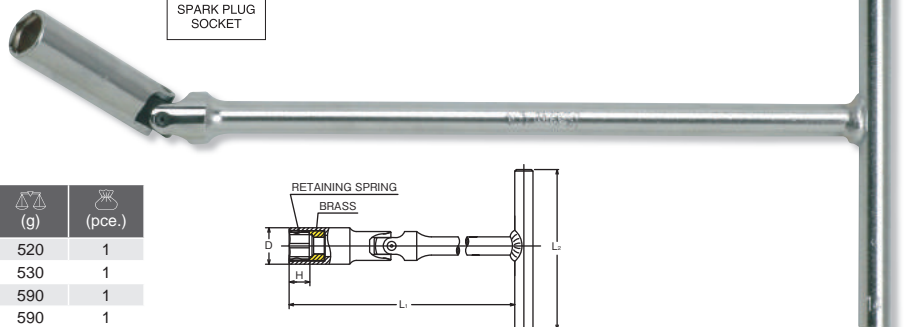

127C.315 (mm)	D (mm)	H (mm)	L ₁ (mm)	L ₂ (mm)	(g)	(pce.)
14	19	11	315	150	520	1
16	21	13	315	150	530	1
18	23.9	12	315	150	590	1
20.8	26.8	13.5	315	150	590	1

⚠ Spring clip type spark plug sockets caused deforming the clip if it would be used with shallow engagement.

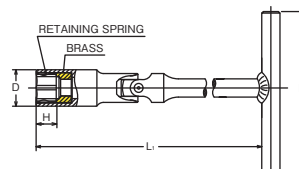

Z-SERIES
HAND
MANUALES
TITANIUM
DE TITANIO
ACCESSORIES
ACCESORIOS
SCREWDRIVERS
DESTORNILLADORES
IMPACT
DE IMPACTO
SLEEVE-DRIVE
INDUSTRIAL
PROTECTOR
PROTECTORES
AUTOMOTIVE
CONSTRUCTION
CONSTRUCCION
RENEWAL KITS
JUEGOS DE HERRAMIENTAS

Z-SERIES
HAND
MANUALES
TITANIUM
DE TITANIO
ACCESSORIES
ACCESORIOS
SCREWDRIVERS
DESTORNILLADORES
IMPACT
DE IMPACTO
SLEEVE-DRIVE
INDUSTRIAL
INDUSTRIALES
PROTECTOR
PROTECTORES
AUTOMOTIVE
RENEWAL KITS
CONSTRUCTION
JUEGOS DE PIEZAS
REPUESTO
CONSTRUCCIÓN

3751N Torque Ratchet for Spark Plugs
Llave de Bujías Dinamométrica



3751J Torque Ratchet for Spark Plugs
Llave de Bujías Dinamométrica



TORQUE RATCHET

The torque is set at 25Nm. When the torque is loaded higher than 25Nm, the gear slips and no increased torque is transmitted. Cylinder heads and spark plugs are protected by this mechanism.

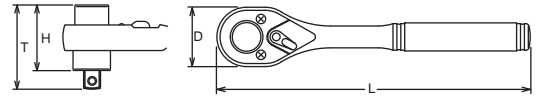

		D (mm)	T (mm)	H (mm)	L (mm)	(g)	(pce.)
3751N-25		34	57	43	178	320	1
3751J-25		34	57	43	178	320	1

3225A Set for Torque Controlled Installation of Spark Plugs
Juego de Llaves de Bujías Dinamométricas



3225A		4 Pieces Set/△=960g	
METAL CASE:W215xH80xT47mm			
Sockets		Accessories	
	3300C Spark Plug Sockets 16, 20.8		3751J-25
			3763-125

3701 Torque Adaptors 20Nm / 30Nm
Adaptadores de Par 20Nm / 30Nm

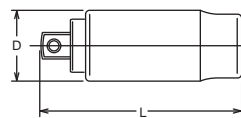

		D (mm)	L (mm)	(g)	(pce.)
20Nm		25.5	75	178	1
30Nm		28	75	220	1



2350G-PSG (mm)		D ₁ (mm)	D ₂ (mm)	H ₁ (mm)	H ₂ (mm)	L (mm)		
12	1/4"	16.5	15.5	12	41	50	41	10



2350G-12PSG

Sockets for PSG-Glow Plugs
Vasos para PSG-Bujías de pre-calentamiento

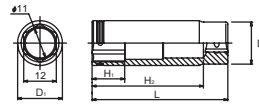

3341G.70 (mm)		D ₁ (mm)	D ₂ (mm)	H (mm)	L (mm)		
10	3/8"	14.5	19	6	70	76	10
11		15.8	19	6	70	80	10
12		17	19	6	70	85	10



3341G-70 · -89

Universal Glow Plug Sockets with NUT GRIP®
Llaves de Calentador con Articulación Universal con Sujeta-Tuerca (Nut Grip®)

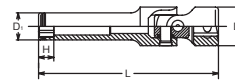

3341G.89 (mm)		D ₁ (mm)	D ₂ (mm)	H (mm)	L (mm)		
8	3/8"	12	19	7.5	89	82	10
9		13.3	19	7.5	89	87	10
10		14.5	19	6	89	92	10
12(DP52)		17	19	12	89	101	10

GLOW PLUG SOCKETS, NUT GRIP®

Twin balls at the 6-point opening hold bolt/nut tightly for safe and reliable work.

El perno/tuerca se sujeta firmemente por medio de dos bolas en la boca hexagonal para un trabajo seguro y fiable



3342G.150 (mm)		D ₁ (mm)	D ₂ (mm)	H (mm)	L (mm)		
8	3/8"	12	18	7.5	150	137	10

3342G-150

Deep length universal Glow Plug Socket
Llave de Calentador Larga con Articulación Universal

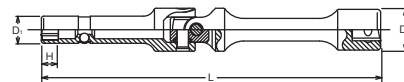

144KM (mm)	L (mm)	D (mm)	C (mm)		
8	200	22.7	7.5	95	1
12	200	22.7	7.5	102	1

144KM

For Glow Plugs
Para Calentadores

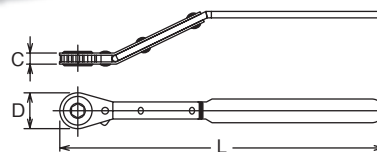

148KM (mm)	L (mm)	D ₁ (mm)	D ₂ (mm)	C (mm)		
8Sx12	245	23.6	24.6	9	187	1

148KM

For Glow Plugs
Para Calentadores

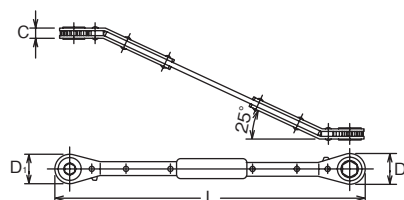



Z-SERIES
HAND
MANUALES
TITANIUM
DE TITANIO
ACCESSORIES
ACCESORIOS
SCREWDRIVERS
DESTORNILLADORES
IMPACT
DE IMPACTO
SLEEVE-DRIVE
INDUSTRIAL
INDUSTRIALES
PROTECTOR
PROTECTORES
AUTOMOTIVE
CONSTRUCTION
CONSTRUCCION
RENEWAL KITS
JUEGOS DE REPARACION

Z-SERIES
HAND
MANUALES
TITANIUM
DE TITANIO
ACCESSORIES
ACCESORIOS
SCREWDRIVERS
DESTORNILLADORES
IMPACT
DE IMPACTO
SLEEVE-DRIVE
INDUSTRIAL
INDUSTRIALES
PROTECTOR
PROTECTORES
AUTOMOTIVE
CONSTRUCTION
CONSTRUCCIÓN
RENEWAL KITS
JUEGOS DE PIEZAS/REPUESTO

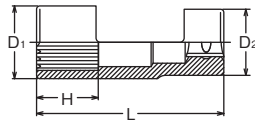
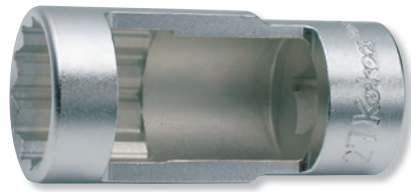
SP4305M-77  Socket for Diesel Engine Injectors
Vaso para Inyectores de Motor Diesel



SP4305M.77 (mm)		D ₁ (mm)	D ₂ (mm)	H (mm)	L (mm)		
27	1/2"	36.5	33	28	77	212	10

SP4305M.77-27
For fuel injection pump of BMW diesel cars.

4133  Socket for Diesel Engine Injectors
Vaso para Inyectores de Motor Diesel

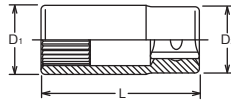



		D ₁ (mm)	D ₂ (mm)	L (mm)		
4133	1/2"	23.9	23	55	86	10

4133
For fuel injection pump of M.B diesel cars.

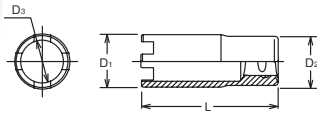
4122-72 Diesel Injection Holder Nut Socket
Vaso Porta Tuerca de Inyección Diesel



4122.72 (mm)		D ₁ (mm)	D ₂ (mm)	D ₃ (mm)	L (mm)		
22	1/2"	28.5	27	22	72	150	10

4122.72-22
For M.B Trucks, Holder nut of injection post.

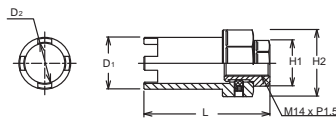

SP4122-69 Diesel Injection Holder Nut Socket
Vaso Porta Tuerca de Inyección Diesel

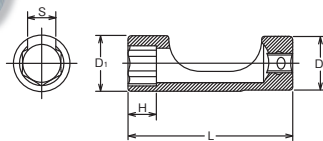

SP4122.69 (mm)	D ₁ (mm)	D ₂ (mm)	H ₁ (mm)	H ₂ (mm)	L (mm)		
22	28.4	22	22	32	69	185	5

3300FN  Flare Nut Sockets
Llaves de vaso para entubar



3300FN (mm)		D ₁ (mm)	D ₂ (mm)	H (mm)	L (mm)	S (mm)		
8	3/8"	14.5	17.3	6	53	6.4	38	10
9		16	17.3	7	53	6.8	41	10
10		16.8	17.2	7.5	53	7.2	42	10
11		18	17	8.5	53	8.3	42	10
12		20	18	9	53	8.8	50	10
13		21.1	20	9.5	62	9.4	66	10
14		22	20	10.5	62	10.5	66	10
15		23	22	11	70	11.5	82	10
16		24	23	11.5	70	12	90	10
17		25	24	12.5	80	13	110	10
18		27	25	13	80	13.5	120	10
19		28	26	14	80	14.5	130	10
22	32	29.5	16	80	16	180	10	
24	34.5	31.5	17	80	17	200	10	

RS3300FN/6	6 Pieces Set/Rail 150mm						
	8, 10, 12, 14, 17, 19						450



RS3300FN/6  Socket Set on Rail
Juego de Vasos en Regleta

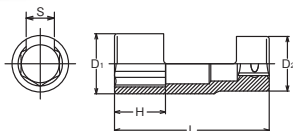
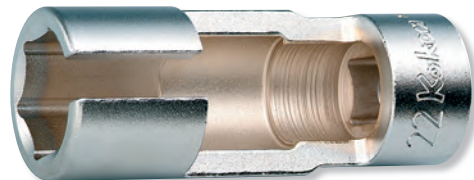

SP4300M-85  Special socket for Lambda Probes
Vaso Especial para Sensores Lambda

SP4300M-110 



		D ₁ (mm)	D ₂ (mm)	H (mm)	L (mm)	S (mm)		
SP4300M.85-22	1/2"	33	30	29	85	8	228	10
SP4300M.110-22		33	30	34	110	8	279	5



FLARE NUT SOCKET
Socket for Lambda Probes
Open section allows for use with wire/connector.

4300H (mm)		D ₁ (mm)	D ₂ (mm)	H ₁ (mm)	H ₂ (mm)	H ₃ (mm)	L (mm)	(g)	(pcs.)
24	1/2"	32.5	27	17	40	24	57	157	10
26		35	27	19	40	24	57	170	10
27		36.1	27	19.5	40	24	57	175	10

4300H series
Removes and installs oil pressure switches

4300H (mm)		D ₁ (mm)	D ₂ (mm)	H ₁ (mm)	H ₂ (mm)	L (mm)	(g)	(pcs.)
27(8P)	1/2"	34	27	18.5	37	57	152	10

4300H(8P) series
Socket for Switches, Mercedes Benz and MAN

4010M.100 (mm)		D (mm)	H (mm)	L (mm)	(g)	(pcs.)
8(12P)	1/2"	23	63.5	100	132	10
10(12P)		23	63.5	100	135	10

4010M.120 (mm)		D (mm)	H (mm)	L (mm)	(g)	(pcs.)
8(12P)	1/2"	23	83.5	120	151	10
10(12P)		23	83.5	120	155	10



Cylinder head bolt socket for TOYOTA
4010M(12P) is Double Hex bit socket.
XZN(Triple Square) bit socket has different shape.

ST4027.140		D (mm)	H (mm)	L (mm)	(g)	(pcs.)
ST4027.140	1/2"	23	103.5	140	155	10



Head Bolt Bit Socket for VW/AUDI
ST4027-140 can not substitute with 3027, 4027-CV bit series.

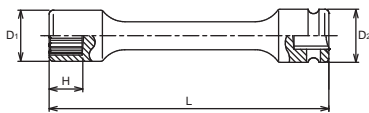

13145M.150 (12P) (mm)		D ₁ (mm)	D ₂ (mm)	H (mm)	L (mm)	(g)	(pce.)	
10	3/8"	15.8	19	10	150	120	1	*1
12		18.3	19	12	150	128	1	*1

*1 C-Ring=1301C, Pin/O-Ring=1301A+B → P254-255

4300H ○ Oil Pressure Switch Sockets
Vasos para Presostatos de Aceite

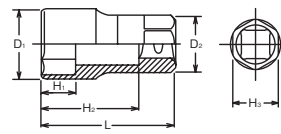

4300H (8P) ○ 8-point Socket
Vaso Octagonales

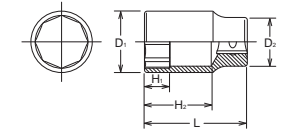

4010M-100 · -120 (12P)

● Bit Sockets for Double Inhex Screws (12-point)
Vasos con Punta para Tornillos Doble Inhex (Bihex)

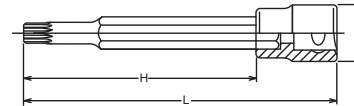

ST4027-140 ● Head Bolt Bit Socket for VW/AUDI
Vasos con Punta para Perno de Culata VW/AUDI

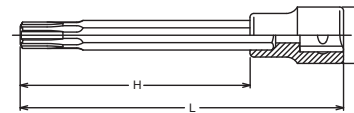
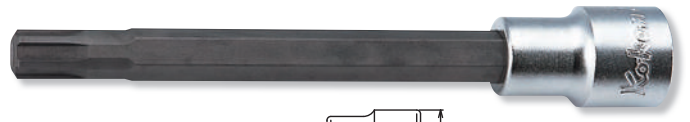

13145M-150 · -200 (12P) ○ Extra Long Sockets
Vasos Extra-Largos



13145M.200 (12P) (mm)		D ₁ (mm)	D ₂ (mm)	H (mm)	L (mm)	(g)	(pce.)	
10	3/8"	15.8	19	10	200	151	1	*1
12		18.3	19	12	200	159	1	*1

*1 C-Ring=1301C, Pin/O-Ring=1301A/B → P254-255

16305M (mm)		D ₁ (mm)	D ₂ (mm)	H ₁ (mm)	H ₂ (mm)	L (mm)	(g)	(pcs.)	
14	3/4"	26.3	44	14	74	100	500	2	*1
17		30	44	17	74	100	544	2	*1
19		32.5	44	19	74	100	655	2	*1
22		36.3	44	22	74	100	700	2	*1

*1 C-Ring=1600C, Pin/O-Ring=1601A+B → P254-255

16305M ○ 12-point Sockets, Deep
Vasos Bihexagonales Largos

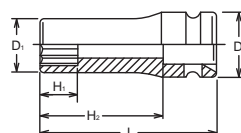



Z-SERIES
HAND
MANUALES
TITANIUM
DE TITANIO
ACCESSORIES
ACCESORIOS
SCREWDRIVERS
DESTORNILLADORES
IMPACT
DE IMPACTO
SLEEVE-DRIVE
INDUSTRIAL
INDUSTRIALES
PROTECTOR
PROTECTORES
AUTOMOTIVE
CONSTRUCTION
CONSTRUCCION
RENEWAL KITS
JUEGOS DE PIEZAS/REBUESTO

Z-SERIES
HAND MANUALES
TITANIUM DE TITANIO
ACCESSORIES ACCESORIOS
SCREWDRIVERS DESTORNILLADORES
IMPACT DE IMPACTO
SLEEVE-DRIVE
INDUSTRIAL INDUSTRIALES
PROTECTOR PROTECTORES
AUTOMOTIVE
RENEWAL KITS CONSTRUCTION JUEGOS DE PIEZAS REPUES TO CONSTRUCCIÓN

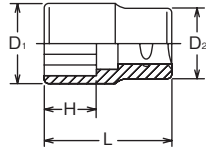
4109M  Double Square Sockets
Vasos Octagonales



4109M (mm)		D ₁ (mm)	D ₂ (mm)	H (mm)	L (mm)	(g)	(pcs.)
14		26.8	26	11	38	110	10
17		30	28	12.5	40	140	10
19		31.5	29	14	40	150	10
21.5		35	32	16	40	170	10
23		37	34	16.5	43	180	10

4109M series
For Lubrication service

4111M  6-point Socket
Vaso Hexagonales

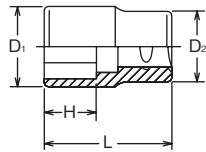

4111M (mm)		D ₁ (mm)	D ₂ (mm)	H (mm)	L (mm)	(g)	(pcs.)
24		32	30	17	40	133	10

4111M
For Lubrication service

4020-60 (MH)  Bit Socket for XZN-Screws with hole
Vaso con Punta para Tornillos XZN con agujero

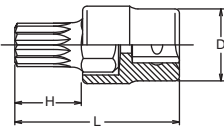

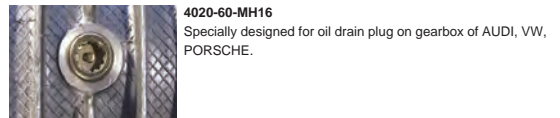

4020.60 (XZN)		D (mm)	H (mm)	L (mm)	(g)	(pcs.)
MH16		24	20	60	135	10



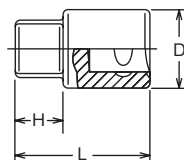

4020-60-MH16
Specially designed for oil drain plug on gearbox of AUDI, VW, PORSCHE.

3110M · 3110A  4-point Male Sockets
Vasos con Macho Cuadrado





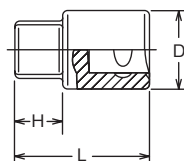

3110M (mm)		D (mm)	H (mm)	L (mm)	(g)	(pcs.)
6		18	10	28	30	10
8		18	10	28	30	10
10		18	10	28	33	10
12		18	10	28	37	10

3110A (inch)		D (mm)	H (mm)	L (mm)	(g)	(pcs.)
5/16		18	10	28	30	10
3/8		18	10	28	33	10
1/2		18	10	28	37	10

4110M · 4110A  4-point Male Sockets
Vasos Macho Cuadrado



4110M (mm)		D (mm)	H (mm)	L (mm)	(g)	(pcs.)
8		24	10	32	57	10
10		24	10	32	62	10
10.5		24	10	32	64	10
12		24	10	32	64	10
13		24	10	32	66	10
13.5		24	10	32	67	10
19		25	15	37	101	10
20		26	15	37	114	10

4110A (inch)		D (mm)	H (mm)	L (mm)	(g)	(pcs.)
3/8		24	10	32	62	10
1/2		24	10	32	64	10

158  For Lubrication Service
Para Lubricación





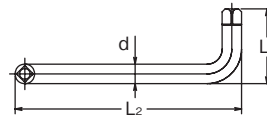

158 (mm)	L ₁ (mm)	L ₂ (mm)	d (mm)	(g)	(pcs.)
8Sx10S	63	230	13	319	1



3012M.25 (mm)		D (mm)	L (mm)	(g)	(pcs.)
14	3/8"	19	25	30	10
17		19	25	30	10

3012M-25  Inhex Sockets
Vasos con Punta Hexagonal





4202		7 Pieces Set/  =426g	
METAL CASE:W190xH59xT45mm			
Sockets			
		106 Drain Plug Keys 8Sx10S, 8Hx3/8H, 10Hx11H, 12Hx13H, 14Hx17H, 19H	
		4102 Drain Plug Key Adaptor	

4202 Drain Plug Keys Set
Juego de Llaves de Tapón de Vaciado



106 (mm)	H ₁ (mm)	H ₂ (mm)	H ₃ (mm)	L (mm)	(g)	(pcs.)
8Sx10S	8	8	17	32	40	10
8Hx3/8H	8	8	17	32	38	10
10Hx11H	8	8	17	32	42	10
12Hx13H	8	8	17	32	47	10
14Hx17H	8	8	17	32	55	10
19H	-	8	17	24	49	10

106   4-point / 6-point Male bits
Puntas Macho Cuadrado / Hexagonal



4102 (mm)		D ₁ (mm)	D ₂ (mm)	H (mm)	L (mm)	(g)	(pcs.)
17	1/2"	25	24	16	40	82	10

4102  Adaptor for 106 Drain Plug Key
Adaptador para llave de tapón de Vaciado 106

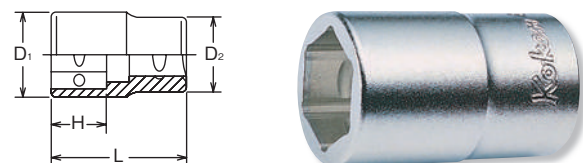

3400M.24 (mm)		D ₁ (mm)	D ₂ (mm)	H (mm)	L (mm)	(g)	(pcs.)
27	3/8"	36.5	21.5	13.5	24	76	10
30		40	25	13.5	24	91	10
32		42.8	28	13.5	24	108	10
36		47.2	32	13.5	24	135	10

3400M-24  6-point Sockets
Vasos Hexagonales



3400M.24 Series
For Oil Filter

Z-SERIES
HAND
MANUALES
TITANIUM
DE TITANIO
ACCESSORIES
ACCESORIOS
SCREWDRIVERS
DESTORNILLADORES
IMPACT
DE IMPACTO
SLEEVE-DRIVE
INDUSTRIAL
INDUSTRIALES
PROTECTOR
PROTECTORES
AUTOMOTIVE
CONSTRUCTION
CONSTRUCCION
RENEWAL KITS
JUEGOS DE REPARACION

Z-SERIES
HAND
MANUALES
TITANIUM
DE TITANIO
ACCESSORIES
ACCESORIOS
SCREWDRIVERS
DESTORNILLADORES
IMPACT
DE IMPACTO
SLEEVE-DRIVE
INDUSTRIAL
INDUSTRIALES
PROTECTOR
PROTECTORES
AUTOMOTIVE
RENEWAL KITS
CONSTRUCTION
JUEGOS DE PIEZAS
REPUES
CONSTRUCCIÓN



1206  Push and Pull-Ratchet Set
Juego de Llave de Carraca de Empuje y Tracción



1206		3 Pieces Set/△=320g
CARDBOARD BOX		
Sockets		Accessory
 150.14H Sockets 12, 14	154K-14	

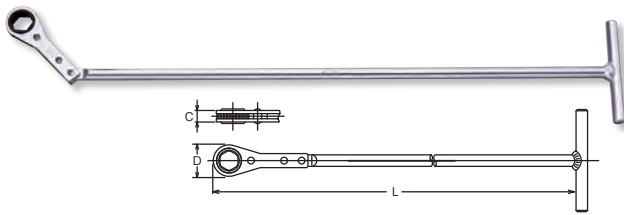

154K  Push and Pull-Ratchets
Llaves de Carraca de Empuje y Tracción



154K (mm)	L (mm)	D (mm)	C (mm)	 (g)	 (pcs.)
14	480	24.6	9	280	1





150-14H  Socket, For 154K
Vasos

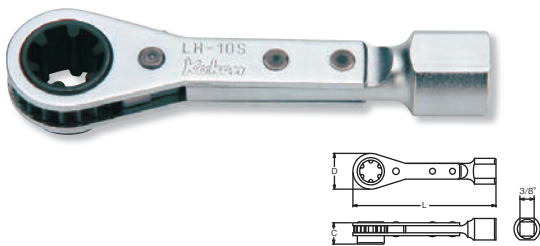

150.14H (mm)	D (mm)	H (mm)	L (mm)	 (g)	 (pcs.)
10	16	5	17	16	10
12	17.3	5	18	14	10
14	19.2	7	21	17	10

145LH3/8F  Belt Tension Pulley Wrench 



145LH3/8F (LH-S)		L (mm)	D (mm)	C (mm)	 (g)	 (pcs.)
10S		100	25	15.5	90	10

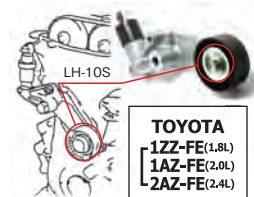

Belt Tension Pulley Wrench
For LH-10S bolt on TOYOTA engines 1ZZ (1.8L), 1AZ (2.0L) and 2AZ (2.4L), belt tension pulley.

 This item has less strength due to the special design.

4282 Generator Service Set



4282		4 Pieces Set/△=449g
PLASTIC BAG		
Sockets		
 4020.100-M10 4020.140-M10		
 4025.100R-T50		
 185		



Generator Service Set
For removing and installing belt pulley at the generator.

1210 • 1210E Door Hinge Wrench Set
Juego de Llave de Bisagra de Puerta

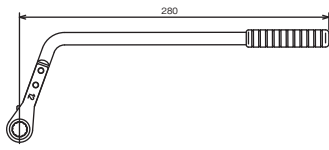

1210 8 Pieces Set/△=450g	
PLASTIC BAG	
Sockets	Accessory
179B.12H Sockets 10, 12	145KD-12
179B.12H XZN Bits M6, M8, M10, M12	
179B.12H TORX® Bit T45	

1210E 11 Pieces Set/△=460g	
PLASTIC BAG	
Sockets	Accessory
179B.12H Sockets 10, 12, 13	145KD-12
179B.12H XZN Bits M8, M10, M12	
179B.12H TORX® Bits T40, T45, T50	
179B.12H Hex Bit 8	

3247 4 Pieces Set/△=385g	
PLASTIC BAG	
Sockets	
3025.160 Tamper-resistant TORX® Bit Sockets T27H, T30H, T40H, T50H	

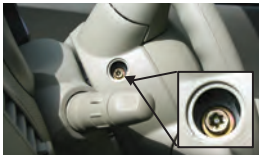

For Air Bag
For air-bag unit in hard to reach places in or around the steering wheel.

Tamper Resistant TORX® Bit Sockets have less strength.

3247 Bit Socket Set
Juego de Vasos con Punta



3300M/4-L120 4 Pieces Set/△=477g	
PLASTIC BAG	
Sockets	
3300M(L120) 6-pt. Extra Deep Sockets 8, 10, 12, 14	



BUMPER BOLT



DOOR HINGE

Extra Deep Socket
Extra deep socket can be used to fasten or loosen longer bolts such as Bumper bolt and Door hinge etc.

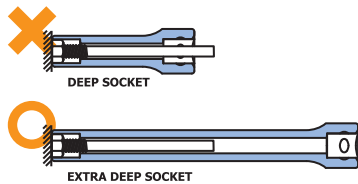

3300M/4-L120 Socket Set
Juego de Vasos



3350M/2-L120 2 Pieces Set/△=230g	
PLASTIC BAG	
Sockets	
3350M(L120) Nut Grip Extra Deep Sockets 10, 12	

Nut Grip Extra Deep Socket

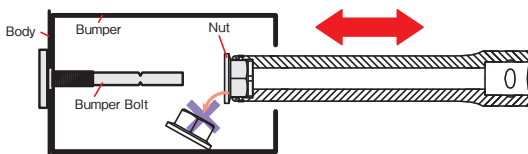

3350M/2-L120 Socket Set
Juego de Vasos

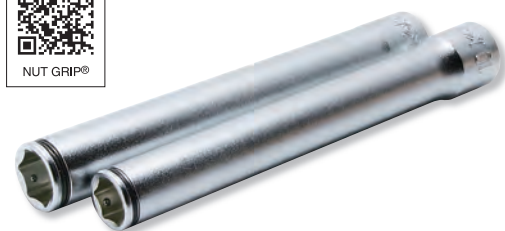

Z-SERIES
HAND MANUALES
TITANIUM DE TITANIO
ACCESSORIES ACCESORIOS
SCREWDRIVERS DESTORNILLADORES
IMPACT DE IMPACTO
SLEEVE-DRIVE
INDUSTRIAL INDUSTRIALES
PROTECTOR PROTECTORES
AUTOMOTIVE
CONSTRUCTION CONSTRUCCIÓN
RENEWAL KITS JUEGOS DE PIEZAS/REPUSTO

1212 Screwdriver Set
Destornilladores, juego de 4 piezas

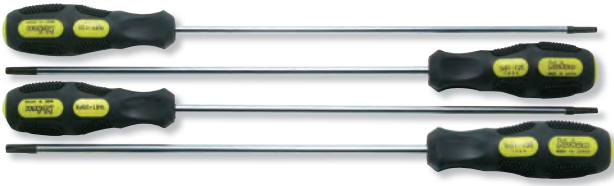

168T (250) Screwdrivers
Destornilladores

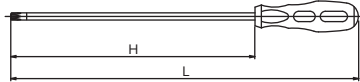

169/2 Door Trim Pad Tool, 2 pieces Set
Herramienta de Forro de Puerta, juego de 2 piezas

169 Door Trim Pad Tool
Herramienta de Forro de Puerta

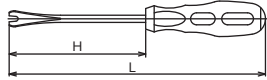
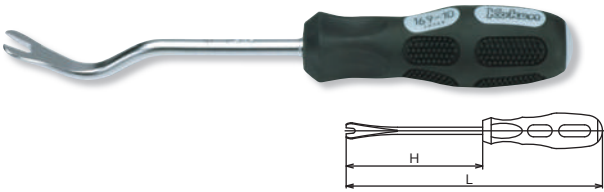

169WM Window Molding Remover
Extractor de Burletes de Ventana

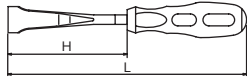

169HR/2 Hose Remover, 2 pieces Set
Extractor de Mangueras, juego de 2 piezas

169HR Hose Remover
Extractor de Mangueras

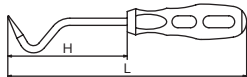

169BP For Battery Screws

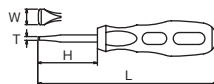

1212 4 Pieces Set/△=380g
PLASTIC BAG

Screwdrivers				
	168T(250) 20IPR			
	168T(250) T20, T25, T30			



Long shank Screw Screwdriver

168T(250) (IPR)	H (mm)	L (mm)	(g)	(pce.)
20IPR	250	350	85	1

168T(250) (T)	H (mm)	L (mm)	(g)	(pce.)
T20	250	350	85	1
T25	250	350	85	1
T30	250	360	120	1

169/2 2 Pieces Set/△=200g
PLASTIC BAG

Clip Handles				
	169			
	6, 10			

169	H (mm)	L (mm)	(g)	(pcs.)
6	115	215	80	2
10	120	230	110	2



Clip Handle

169WM	H (mm)	L (mm)	(g)	(pcs.)
169WM	100	210	90	2



Window Molding Remover

169HR/2 2 Pieces Set/△=180g
PLASTIC BAG

Hose Remover				
	169HR			
	A, B			

169HR	H (mm)	L (mm)	(g)	(pcs.)
A	100	200	75	2
B	100	200	90	2



Hose Remover

169BP	TxW (mm)	H (mm)	L (mm)	(g)	(pcs.)
1.8x13	1.8x13	50	150	60	2



For Battery screw



Quick Fastener

TORX is a registered trademark of Acument Intellectual Properties, LLC.
TORX es una marca registrada de Acument Intellectual Properties, LLC.
TORX is a registered trademark of Acument Intellectual Properties, LLC.
TORX es una marca registrada de Acument Intellectual Properties, LLC.

4425 (E)		D ₁ (mm)	D ₂ (mm)	H (mm)	L (mm)	(g)	(pcs.)
E10N	1/2"	13.2	21	8.2	36	47	10
E12N		14.6	21	9.3	37	48	10
E14N		16.5	21	10.6	37	50	10
E16N		19	22	11.8	37	60	10
E18N		20.3	22	13	37	60	10
E20N		22.8	22	14.4	37	65	10

RS4425/6-N	6 Pieces Set/Rail 200mm	(g)
E10N, E12N, E14N, E16N, E18N, E20N		370



Engine type : QR/MR
Flywheel bolt for NISSAN: E20N

13145A.150 (inch)		D ₁ (mm)	D ₂ (mm)	H (mm)	L (mm)	(g)	(pce.)	
9/16(D20)	3/8"	20	19	13	150	130	1	*1

*1 C-Ring=1301C, Pin/O-Ring=1301A/B → P254-255

14145A.150 (inch)		D ₁ (mm)	D ₂ (mm)	H (mm)	L (mm)	(g)	(pce.)	
9/16(D20)	1/2"	20	25	13	150	200	1	*1

*1 C-Ring=1401C, Pin/O-Ring=1401A/B → P254-255

For Land Rover Prop Shaft

		D ₁ (mm)	D ₂ (mm)	L (mm)	(g)	(pcs.)	
New 13772-B	3/8"	22	19	75	120	5	*1
13772-P		22	19	75	120	5	*1
New 14772-B	1/2"	27	25	90	230	1	*2
14772-P		27	25	90	230	1	*2

*1 C-Ring=1301C, Pin/O-Ring=1301A/B
*2 C-Ring=1401C, Pin/O-Ring=1401A/B → P254-255

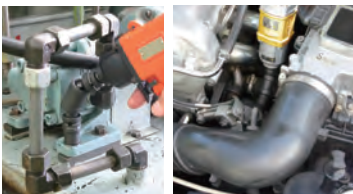

UNIVERSAL DOUBLE JOINT

13772 and 14772 have less load capacity than standard. In the interest of your safety always use properly.

14305M (mm)		D ₁ (mm)	D ₂ (mm)	H ₁ (mm)	H ₂ (mm)	L (mm)	(g)	(pcs.)	
30	1/2"	42	30	30	63	85	457	10	*2
32		44.5	30	32	63	85	542	10	*2
36		49.5	30	36	61	85	635	2	*2

*2 C-Ring=1402C, Pin/O-Ring=1402A/B → P254-255



4101		T×W (mm)	D (mm)	L (mm)	(g)	(pcs.)
1	1/2"	2.7×18.6	22	40	59	10
2		3.7×24	24	40	79	10
3		3.7×30	30	40	128	10

6101		T×W (mm)	D (mm)	L (mm)	(g)	(pcs.)
6101	3/4"	6.4×33.5	35	50	205	5

4425-N TORX® Sockets
For Nut/Low Profile Head Bolt

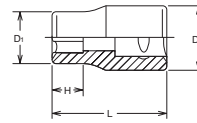

RS4425/6-N Socket Set on Rail
Juego de Vasos en Regleta



13145A-150 Extra Long Sockets
14145A-150 Vasos Extra-Largos

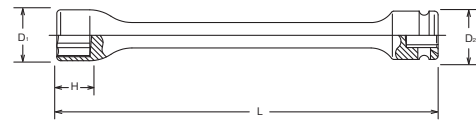

13772 Universal Double Joint
14772 Articulación Universal

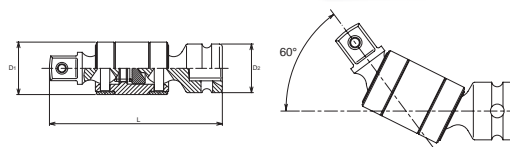

14305M 12-point Deep Sockets
Vasos Bihexagonales Largos

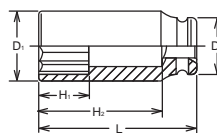



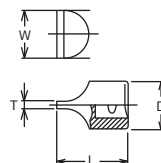

4101 · 6101 Sockets for Slotted Heads
Vasos para Cabeza Ranurada

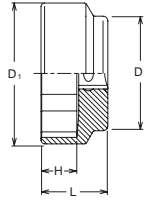

4400M-DU  Rear Wheel Nut Socket







4400M		D ₁ (mm)	D ₂ (mm)	H (mm)	L (mm)	 (g)	 (pcs.)
41DU		53	45	15	28	240	5
46DU		59	48	15	28	280	5

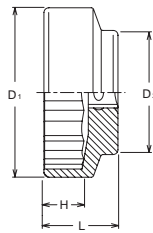

4405M-DU  Rear Wheel Nut Socket







4405M		D ₁ (mm)	D ₂ (mm)	H (mm)	L (mm)	 (g)	 (pcs.)
36DU		47.3	41	15	28	200	5
55DU		71	52	16	31	410	5

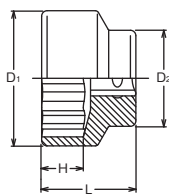
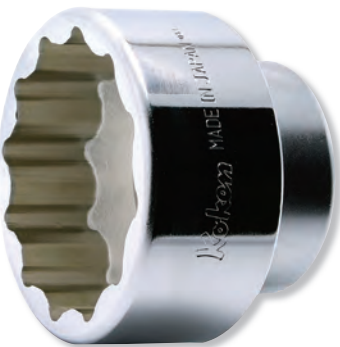

6405A-MV  Rear Wheel Nut Socket







6405A		D ₁ (mm)	D ₂ (mm)	H (mm)	L (mm)	 (g)	 (pcs.)
2.3/16MV		74.6	53	23	52	790	2

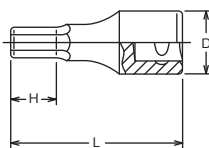

4012M-43  Inhex Sockets
Vasos Inhex



4012M.43 (mm)		D (mm)	H (mm)	L (mm)	 (g)	 (pcs.)
20		26	11.5	43	130	10
21		26	11.5	43	140	10
22		26	11.5	43	145	10
24		28	11.5	43	170	10
27		32	11.5	43	226	10



	D (mm)	d (mm)	L (mm)	(g)	(pcs.)
155	22	10	170	100	10

For Motorcycles



155 Tyre Lever
Llave de Neumáticos

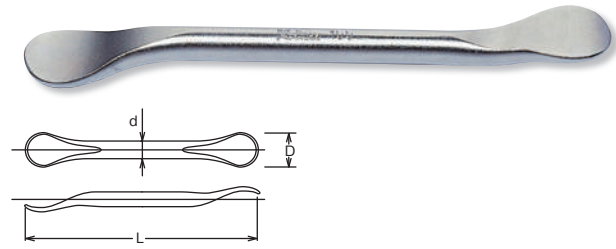

104M (mm)	D (mm)	H (mm)	L ₁ (mm)	L ₂ (mm)	(g)	(pce.)
6	9.5	8	200	180	150	1
7	11	9	200	180	152	1
8	12	10	250	200	183	1
9	14	12	250	200	188	1
10	14	13	250	200	230	1
11	16	14	250	200	234	1
12	18	15	250	250	384	1
13	18.5	17	300	250	412	1
14	20	18	300	250	428	1
15	21	19	300	250	443	1
16	22.5	21	350	300	528	1
17	24	22	350	300	707	1
18	25	23	350	300	707	1
19	26.5	25	350	300	717	1

104M 6-point
Hexagonal

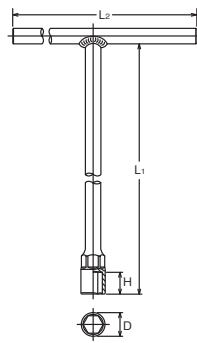

157H (mm)	L ₁ (mm)	L ₂ (mm)	(g)	(pce.)
3	160	100	57	1
4	200	120	70	1
5	250	160	90	1
6	300	190	147	1
8	300	190	245	1
10	300	190	433	1
12	320	210	662	1

157P (PH)	L ₁ (mm)	L ₂ (mm)	(g)	(pce.)
2	200	180	84	1
3	300	180	189	1

157T (T)	L ₁ (mm)	L ₂ (mm)	(g)	(pce.)
T25	250	180	95	1
T27	250	180	96	1
T30	250	180	167	1
T40	250	180	168	1
T45	250	180	213	1
T50	250	180	215	1

157H For Inhex Screws
Para Tornillos de Seis Lados en el Interior (Inhex)

157P For Phillips Screws
Para Tornillos Phillips

157T For TORX® Screws
Para Tornillos TORX®

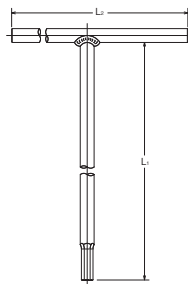

Z-SERIES
HAND
MANUALES
TITANIUM
DE TITANIO
ACCESSORIES
ACCESORIOS
SCREWDRIVERS
DESTORNILLADORES
IMPACT
DE IMPACTO
SLEEVE-DRIVE
INDUSTRIAL
INDUSTRIALES
PROTECTOR
PROTECTORES
AUTOMOTIVE
CONSTRUCTION
CONSTRUCCION
RENEWAL KITS
JUEGOS DE HERRAMIENTAS

Z-SERIES
HAND MANUALES
TITANIUM DE TITANIO
ACCESSORIES ACCESORIOS
SCREWDRIVERS DESTORNILLADORES
IMPACT DE IMPACTO
SLEEVE-DRIVE
INDUSTRIAL INDUSTRIALES
PROTECTOR PROTECTORES
AUTOMOTIVE
RENEWAL KITS CONSTRUCTION JUEGOS DE PIEZAS REPUSTO CONSTRUCCIÓN

14201M
14145PM-110

○ Wheel Nut Sockets Set
Juego de Vasos para Rueda ⚠
○ Wheel Nut Sockets
Vasos para Rueda ⚠

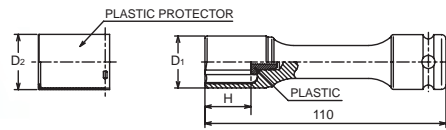

14201M 3 Pieces Set/⚖️=690g
CARDBOARD BOX:W125xH95xT34mm
Sockets
○ 14145PM.110 Impact Wheel Nut Sockets
17, 19, 21

14145PM.110 (mm)	□	D ₁ (mm)	D ₂ (mm)	H (mm)	Shaft Colour	⚖️ (g)	📦 (pcs.)	⚡
17		23.7	25.2	21	Blue	208	5	*1
19	1/2"	25.7	27.2	23	Red	219	5	*1
21		27.5	29	25	Yellow	226	5	*1
22		29	30.5	26	White	238	5	*1

*1 C-Ring=1401C, Pin/O-Ring=1401A/B ➡ P254-255



Impact Wheel Nut Sockets-Extra Thin wall
Special design for wheel nut work.
-110mm length gives socket extra reach for nuts recessed deep inside the wheel and ideal for Aluminum wheel nuts where access to nut is very tight.
-Blue (17mm), Red (19mm), Yellow (21mm) and White (22mm), colour coded shafts make size identification easy.
-Plastic insert helps prevent damaged to wheel nut.

⚠ Please note that thin walled design is only for wheel nut work and Torque rating is limited.

A detachable plastic protector is fitted to the socket to prevent damage to the wheel when working in tight areas.
The socket size and Ko-ken mark printed on the shaft makes it easier to see if the socket is still rotating or stopped.

- 198-17 : Spare Plastic Protector for 14145PM.110-17 : 10 pcs.
- 198-19 : Spare Plastic Protector for 14145PM.110-19 : 10 pcs.
- 198-21 : Spare Plastic Protector for 14145PM.110-21 : 10 pcs.
- 198-22 : Spare Plastic Protector for 14145PM.110-22 : 10 pcs.

280PM

○ Adaptor Socket for Low Profile Wheel Nut
Vaso Adaptador para tuercas de Llantas de perfil bajo ⚠

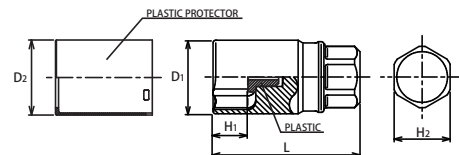

280PM (mm)	D ₁ (mm)	D ₂ (mm)	H ₁ (mm)	H ₂ (mm)	L (mm)	Shaft Colour	⚖️ (g)	📦 (pcs.)
19	25.7	27.2	13	19	52	Red	150	5
21	27.5	29	13	21	55	Yellow	180	5

Designed for Low Profile Wheel nut socket.
Detachable plastic protector is fitted to the adaptor to prevent damage to painted or surface treatment area on the wheel.
The Plastic insert locate inside of the adaptor helps prevent damage to wheel nut.
Colour coded band make size identification easy.

Diseñado para Vasos de Tuercas de Llantas de perfil bajo
Protector plástico desmontable es ajustado al adaptador para proteger la superficie pintada o con recubrimiento superficial de la llanta
El inserto plástico localizado dentro del adaptador, protege la tuerca de la llanta
La banda coloreada consigue una fácil identificación de la medida

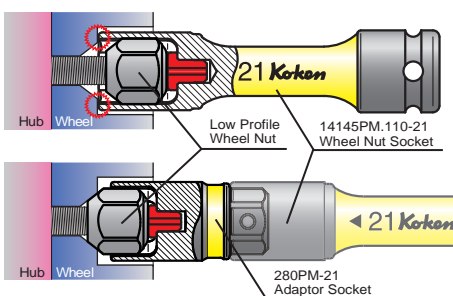

⚠ Please note that thin walled design is only for wheel nut work and Torque rating is limited.

4300M(L60) (mm)		D (mm)	H ₁ (mm)	H ₂ (mm)	L (mm)	(g)	(pcs.)
17	1/2"	23.6	25	21	60	98	10
19		25.1	25	21	60	100	10
21		27.1	25	21	60	102	10



Wheel Nut Sockets

Please note that thin walled design is only for wheel nut work and Torque rating is limited.

4300M (L60) Wheel Nut Sockets
Vasos para Ruedas

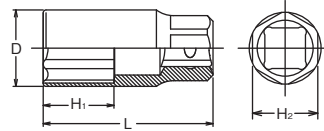

4300M(L110) (mm)		D ₁ (mm)	D ₂ (mm)	H (mm)	L (mm)	(g)	(pcs.)
17	1/2"	23	22	32	110	155	5
19		25.8	22	32	110	170	5
21		26.8	22	32	110	165	5

Please note that thin walled design is only for wheel nut work and Torque rating is limited.

4300M (L110) Wheel Nut Sockets (Long)
Vasos para Ruedas (Largos)

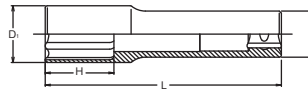

4711X Spinning Cross Wrench

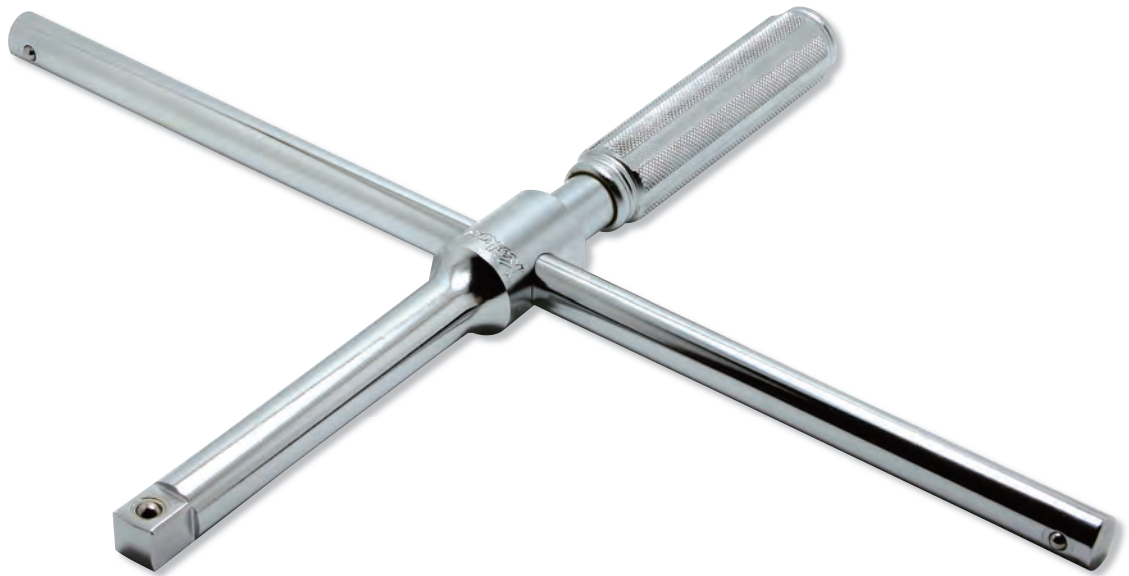

FREE-TURN
CROSS WRENCH



4711X		L ₁ (mm)	L ₂ (mm)	L ₃ (mm)	(g)	(pce.)
4711X	1/2"	140	280	350	945	1

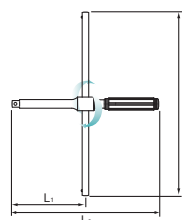



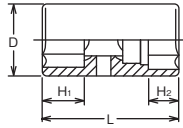

Z-SERIES
HAND
MANUALES
TITANIUM
DE TITANIO
ACCESSORIES
ACCESORIOS
SCREWDRIVERS
DESTORNILLADORES
IMPACT
DE IMPACTO
SLEEVE-DRIVE
INDUSTRIAL
INDUSTRIALES
PROTECTOR
PROTECTORES
AUTOMOTIVE
CONSTRUCTION
CONSTRUCCION
RENEWAL KITS
JUEGOS DE PIEZAS/REUESTO

Z-SERIES
HAND
MANUALES
TITANIUM
DE TITANIO
ACCESSORIES
ACCESORIOS
SCREWDRIVERS
DESTORNILLADORES
IMPACT
DE IMPACTO
SLEEVE-DRIVE
INDUSTRIAL
INDUSTRIALES
PROTECTOR
PROTECTORES
AUTOMOTIVE
CONSTRUCTION
RENEWAL KITS
JUEGOS DE PIEZAS REPUES
CONSTRUCCIÓN



14118M  Wheel Nut Sockets, Double Ended
Vasos para Rueda, Dos Bocas



14118M (mm)		D (mm)	H ₁ (mm)	H ₂ (mm)	L (mm)	 (g)	 (pcs.)
17x19		28	15.5	13	48	150	10
19x21		31	17.5	13	57	177	10
19x22		31	17.5	15	57	187	10

14218M  Wheel Nut Sockets, Double Ended with Extension Bar
Vasos para Rueda, Dos Bocas con Alargado 







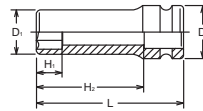
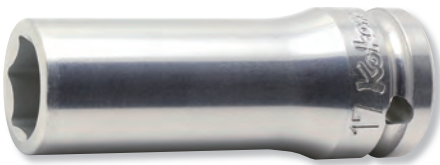

14218M		2 Pieces Set  =360g	
CARDBOARD BOX			
Sockets		Accessory	
	14118PM 19x21		14760ST-B

Interchangeable Wheel Nut Socket of 19mm and 21mm.

 Please note that thin walled design is only for wheel nut work and Torque rating is limited.
Socket is not completely locked with the Ball-type connection.
Please beware of accidental socket release.

AN14300  Impact Sockets, Aluminium Alloyed, for Aluminium Wheel Nuts
Vasos de Impacto, de Aleación de Aluminio, para tuercas de rueda de aluminio





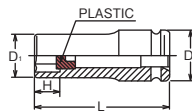

AN14300 (mm)		D ₁ (mm)	D ₂ (mm)	H ₁ (mm)	H ₂ (mm)	L (mm)	 (g)	 (pcs.)	
17		25.7	30	17	62	80	85	10	*2
19		28.2	30	19	61	80	89	10	*2
21		30.7	30	21	61	80	93	10	*2

*2 C-Ring=1402C, Pin/O-Ring=1402A/B  P254-255

14113J  Impact Sockets with Plastic Stops for Hub Cap Screws
Vasos de Impacto con Topes de Plástico para Tornillos de Tapacubos





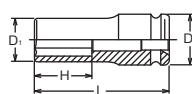

14113J (mm)		D ₁ (mm)	D ₂ (mm)	H (mm)	L (mm)	 (g)	 (pcs.)	
17		25.7	30	14	80	251	10	*2
19		28.2	30	16	80	286	10	*2
21		30.7	30	20	80	309	10	*2

*2 C-Ring=1402C, Pin/O-Ring=1402A/B  P254-255

14113M  For Hub Cap Screws
Para Tornillos de Tapacubos



14113M (mm)		D ₁ (mm)	D ₂ (mm)	H (mm)	L (mm)	 (g)	 (pcs.)	
17		25.7	30	34	80	230	10	*2
19		28.2	30	38	80	262	10	*2
21		30.7	30	42	80	285	10	*2

*2 C-Ring=1402C, Pin/O-Ring=1402A/B  P254-255

14124 (mm)		D ₁ (mm)	D ₂ (mm)	H ₁ (mm)	H ₂ (mm)	L (mm)		
21x24.5	1/2"	28	29.5	24	25	65	157	10
26x27.5		31.5	35	24.5	24.5	65	197	10

14124 Lock Nut Busters (Double Ended)
Tronzador de Tuercas (Dos Bocas)

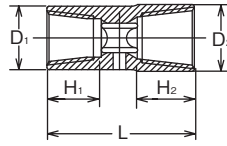

14124/3		3 Pieces Set/=580g	
CARDBOARD BOX:W125xH91xT43mm			
Sockets		Accessory	
	14124 21x24.5 26x27.5		14760-75B



14124/3 Lock Nut Busters (Double Ended) in set
Juego Tronzador de Tuercas (Dos Bocas)



14124 (mm)		D ₁ (mm)	D ₂ (mm)	H (mm)	L (mm)			
17	1/2"	20.5	25	15	50	83	10	*1
18		21	25	15	50	83	10	*1
18.5		23	25	15	50	95	10	*1
19		25	30	20.5	50	140	10	*2
21		28	30	20.5	50	153	10	*2
24.5		29.5	30	23	50	138	10	*2
26		31.5	30	23	50	147	10	*2
27.5		35	30	23	50	181	10	*2

*1 C-Ring=1401C, Pin/O-Ring=1401A/B
*2 C-Ring=1402C, Pin/O-Ring=1402A/B P254-255

14124 Lock Nut Busters
Tronzador de Tuercas

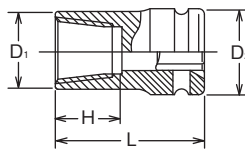

RS14124/7	7 Pieces Set/Rail 250mm	
18, 18.5, 19, 21, 24.5, 26, 27.5		980

RS14124/7 Socket Set on Rail
Juego de Vasos en Regleta



Z-SERIES
HAND
MANUALES
TITANIUM
DE TITANIO
ACCESSORIES
ACCESORIOS
SCREWDRIVERS
DESTORNILLADORES
IMPACT
DE IMPACTO
SLEEVE-DRIVE
INDUSTRIAL
INDUSTRIALES
PROTECTOR
PROTECTORES
AUTOMOTIVE
CONSTRUCTION
CONSTRUCCION
RENEWAL KITS
JUEGOS DE PIEZAS/REPOSTO

Z-SERIES
HAND MANUALES
TITANIUM DE TITANIO
ACCESSORIES ACCESORIOS
SCREWDRIVERS DESTORNILLADORES
IMPACT DE IMPACTO
SLEEVE-DRIVE
INDUSTRIAL INDUSTRIALES
PROTECTOR PROTECTORES
AUTOMOTIVE
CONSTRUCTION CONSTRUCCIÓN
RENEWAL KITS JUEGOS DE PIEZAS REPUESTO

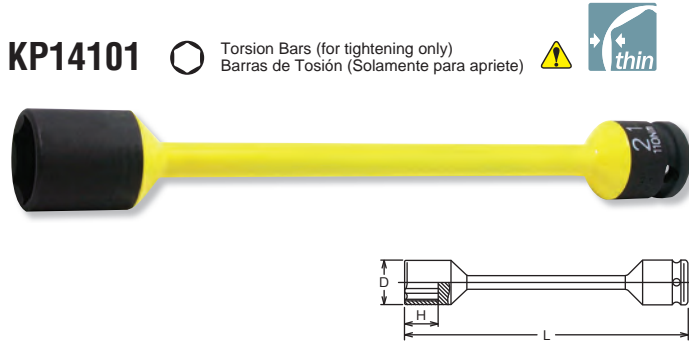

KP14101 (mmxNm)	D (mm)	H (mm)	L (mm)	Shaft Colour	(g)	(pcs.)	
17x110Nm	24	21	204	Blue	230	10	*1
19x 90Nm	26	24	259	White	250	10	*1
19x110Nm	26	24	213	Red	240	10	*1
21x100Nm	28	27	215	Green	255	10	*1
21x110Nm	28	27	216	Yellow	250	10	*1
21x130Nm	28	27	207	Orange	305	10	*1

*1 C-Ring=1401C, Pin/O-Ring=1401A/B → P254-255

How to use Torsion Bar:

1. Use with a 1/2" Sq. Dr. Pneumatic impact wrench.
2. Set air pressure 0.6MPa, and set impact wrench dial Medium range.
3. Chose a suitable Torsion bar according to wheel nut size and indicated tightening torque.
4. Attach the torsion bar to impact wrench and apply load.
5. Check the actual tightening torque value with torque wrench.
6. Adjust air pressure or torque value according to the results of check 5.
7. Tight other wheel nut in diagonal order.

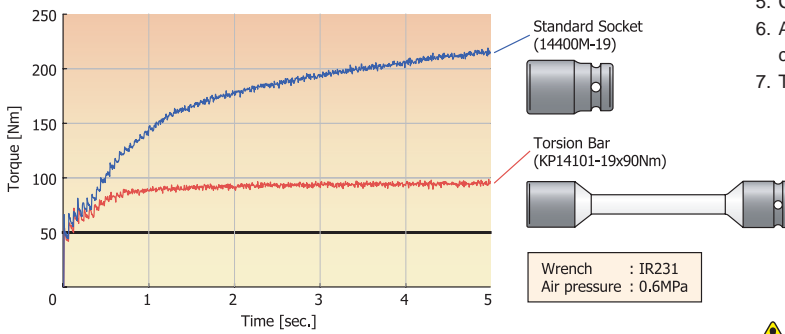

Torsion Bars

- Designed for tightening wheel nuts with an impact wrench.
- Prevent the excessive torque road.
- Colour coded shafts make size identification easy.

 As the torque could vary with the type and the condition of the impact wrench, we strongly recommend the control with a torque wrench.

Como el par puede variar según el estado de la llave de impacto, se recomienda utilizar una llave dinométrica.



KP14101/6S 6 Pieces Set/△=2,230g
DISPLAY STAND

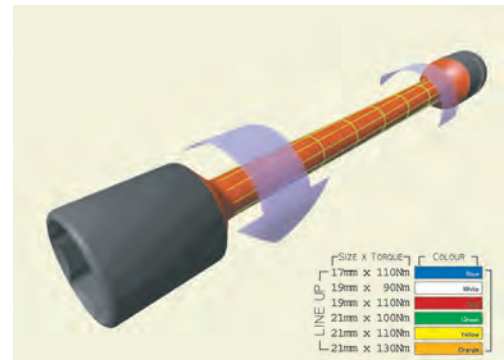

Torsion Bars
 **KP14101** Impact Torsion Bars (Thin walled)
17x110Nm, 19x90Nm, 19x110Nm, 21x100Nm, 21x110Nm, 21x130Nm





KP14101/6H 6 Pieces Set/△=2,230g
HANGER

Torsion Bars
 **KP14101** Impact Torsion Bars (Thin walled)
17x110Nm, 19x90Nm, 19x110Nm, 21x100Nm, 21x110Nm, 21x130Nm

Z-SERIES
HAND
MANUALES
TITANIUM
DE TITANIO
ACCESSORIES
ACCESORIOS
SCREWDRIVERS
DESTORNILLADORES
IMPACT
DE IMPACTO
SLEEVE-DRIVE
INDUSTRIAL
INDUSTRIALES
PROTECTOR
PROTECTORES
AUTOMOTIVE
CONSTRUCTION
CONSTRUCCION
RENEWAL KITS
JUEGOS DE PIEZAS/REPOSTO

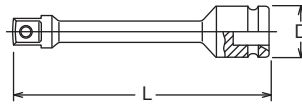
14112  Torsion Extension Bars (for tightening only)
Alargaderas de Torsión (solamente para apriete) 





14112		D (mm)	L (mm)	(g)	(pce.)	
90NmP	1/2"	25	208	206	1	*1
95NmP		25	202	200	1	*1
100NmP		25	196	198	1	*1
110NmP		25	213	220	1	*1
120NmP		25	201	219	1	*1
140NmP		25	205	230	1	*1
170NmP		25	195	257	1	*1

*1 C-Ring=1401C, Pin/O-Ring=1401A/B  P254-255

14101M  Torsion Bars (for tightening only)
Barras de Torsión (solamente para apriete) 





14101M (mmxNm)		D (mm)	H (mm)	L (mm)	(g)	(pce.)	
14x 95Nm	1/2"	22	11	208	230	1	*1
15x110Nm		23.2	11	201	230	1	*1
17x 60Nm		25.7	12	216	227	1	*1
17x 75Nm		25.7	12	228	240	1	*1
17x 95Nm		25.7	12	214	256	1	*1
17x110Nm		25.7	12	204	285	1	*1
17x120Nm		25.7	12	200	284	1	*1
19x 60Nm		28.2	13	219	237	1	*1
19x 90Nm		28.2	13	259	275	1	*1
19x110Nm		28.2	13	214	278	1	*1
19x120Nm		28.2	13	203	297	1	*1
19x135Nm		28.2	13	206	339	1	*1
19x170Nm		28.2	13	190	332	1	*1
21x100Nm		30.7	14	214	288	1	*1
21x120Nm		30.7	14	203	288	1	*1
22x160Nm		32	15	209	385	1	*1

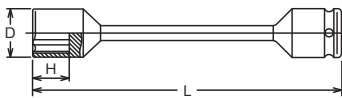

*1 C-Ring=1401C, Pin/O-Ring=1401A/B  P254-255

16101M · 18101M  Torsion Bars (for tightening only)
Barras de Torsión (solamente para apriete) 



16101M (mmxNm)		D (mm)	H (mm)	L (mm)	(g)	(pce.)	
24x180Nm	3/4"	38.8	24	235	850	1	*1
27x450Nm		42.5	27	280	1236	1	*1
32x600Nm		48.8	32	280	1370	1	*1
33x600Nm		50	33	280	1370	1	*1

*1 C-Ring=1600C, Pin/O-Ring=1601A/B  P254-255

18101M (mmxNm)		D (mm)	H (mm)	L (mm)	(g)	(pce.)	
24x350Nm	1"	43.5	24	300	1380	1	*1
27x350Nm		47	27	300	1401	1	*1
27x450Nm		47	27	300	1579	1	*1
30x500Nm		51	30	300	1563	1	*1
32x450Nm		53.5	32	300	1600	1	*1
32x550Nm		53.5	32	300	1602	1	*1
32x600Nm		53.5	32	300	1602	1	*1
32x700Nm		51.5	32	300	1630	1	*1
33x550Nm		55	33	300	1638	1	*1
33x600Nm		55	33	300	1638	1	*1
36x600Nm		58.5	36	300	1718	1	*1

*1 C-Ring=1801C, Pin/O-Ring=1801A/B  P254-255

 As the torque could vary with the type and the condition of the impact wrench, we strongly recommend the control with a torque wrench.

Como el par puede variar según el estado de la llave de impacto, se recomienda utilizar una llave dinamométrica.

Z-SERIES
HAND MANUALES
TITANIUM DE TITANIO
ACCESSORIES ACCESORIOS
SCREWDRIVERS DESTORNILLADORES
IMPACT DE IMPACTO
SLEEVE-DRIVE
INDUSTRIAL INDUSTRIALES
PROTECTOR PROTECTORES
AUTOMOTIVE
RENEWAL KITS CONSTRUCTION JUEGOS DE PIEZAS REPUESTO CONSTRUCCIÓN

6102M-400 8102M-400

Extra long Sockets for Wheel Nuts
Vasos de para Rueda Extra-largos

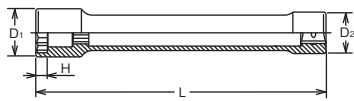

6102M.400 (mm)	□	D ₁ (mm)	D ₂ (mm)	H (mm)	L (mm)	(g)	(pce.)
41Wx21W	3/4"	58	40	14	400	1880	1
32		48.5	40	32	400	1480	1
33		49.8	40	32	400	1500	1

8102M.400 (mm)	□	D ₁ (mm)	D ₂ (mm)	H (mm)	L (mm)	(g)	(pce.)
41Wx21W	1"	58	49.9	14	400	2610	1
32		48.5	49.9	32	400	2210	1
33		49.8	49.9	32	400	2220	1

⚠ 6102M/8102M are for hand use only. Do not use with a power impact wrench.



Combination type. 41Wx21W

Extra long Socket for wheel nut

16102M-270 · -400 18102M-270 · -400

Extra long Sockets for Wheel Nuts
Vasos de Impact para Rueda Extra-largos



16102M.270 (mm)	□	D ₁ (mm)	D ₂ (mm)	H (mm)	L (mm)	(g)	(pce.)	Ⓢ
24	3/4"	38.8	44	24	270	1034	1	*1
27		42.5	44	27	270	1088	1	*1
30		46.3	44	30	270	1144	1	*1
32		48.8	44	32	270	1157	1	*1
33		50	44	32	270	1200	1	*1
36		53.8	44	32	270	1250	1	*1
38		56.3	44	32	270	1610	1	*1
41		60	44	32	270	1640	1	*1

*1 C-Ring=1600C, Pin/O-Ring=1601A/B → P254-255

18102M.270 (mm)	□	D ₁ (mm)	D ₂ (mm)	H (mm)	L (mm)	(g)	(pce.)	Ⓢ
23	1"	37.3	54	23	270	1627	1	*1
24		38.5	54	24	270	1628	1	*1
26		41	54	26	270	1667	1	*1
27		42.3	54	27	270	1680	1	*1
29		44.8	54	29	270	1680	1	*1
30		46	54	30	270	1680	1	*1
32		48.5	54	32	270	1680	1	*1
33		49.8	54	32	270	1700	1	*1
34		51	54	32	270	1750	1	*1
36		53.5	54	32	270	1750	1	*1
38	56	54	32	270	1822	1	*1	
41	60	54	32	270	1800	1	*1	

*1 C-Ring=1801C, Pin/O-Ring=1801A/B → P254-255

16102M.400 (mm)	□	D ₁ (mm)	D ₂ (mm)	H (mm)	L (mm)	(g)	(pce.)	Ⓢ
24	3/4"	38.8	44	24	400	1430	1	*1
27		42.5	44	27	400	1460	1	*1
30		46.3	44	30	400	1510	1	*1
32		48.8	44	32	400	1530	1	*1
33		50	44	32	400	1530	1	*1
36		53.8	44	32	400	2180	1	*1

*1 C-Ring=1600C, Pin/O-Ring=1601A/B → P254-255

18102M.400 (mm)	□	D ₁ (mm)	D ₂ (mm)	H (mm)	L (mm)	(g)	(pce.)	Ⓢ
23	1"	37.3	54	23	400	1865	1	*1
24		38.5	54	24	400	1869	1	*1
26		41	54	26	400	1925	1	*1
27		42.3	54	27	400	2272	1	*1
29		44.8	54	29	400	2278	1	*1
30		46	54	30	400	2266	1	*1
32		48.5	54	32	400	2322	1	*1
33		49.8	54	32	400	2320	1	*1
34		51	54	32	400	2341	1	*1
36		53.5	54	32	400	2442	1	*1
38	56	54	32	400	2550	1	*1	

*1 C-Ring=1801C, Pin/O-Ring=1801A/B → P254-255

PW6 (mmxmm)		D ₁ (mm)	D ₂ (mm)	H (mm)	L (mm)	(g)	(pcs.)	
32x17	3/4"	47	44	12	75	633	2	*1
35x17		50	44	13	75	673	2	*1
38x20		55	44	14	75	708	2	*1
41x19		58	44	14	80	840	2	*1
41x20		58	44	14	80	840	2	*1
41x21		58	44	14	80	831	2	*1

*1 C-Ring=1600C, Pin/O-Ring=1601A/B → P254-255

PW8 (mmxmm)		D ₁ (mm)	D ₂ (mm)	H (mm)	L (mm)	(g)	(pcs.)	
35x17	1"	50	54	13	83	935	2	*1
38x20		55	54	14	83	1038	2	*1
41x19		58	54	14	87	1100	2	*1
41x20		58	54	14	87	1096	2	*1
41x21		58	54	14	87	1089	2	*1

*1 C-Ring=1801C, Pin/O-Ring=1801A/B → P254-255

SIZE	VEHICLE	SIZE	VEHICLE
32 x 17	TOYOTA (~2t)	41 x 19	MAZDA (3~4t)
35 x 17	NISSAN (~3t) MITSUBISHI (~4t) MAZDA (~2t) ISUZU (~3.5t)	41 x 20	TOYOTA (2t~) DAIHATSU (2~3.5t) HINO (2~3.5t)
38 x 20	MITSUBISHI (2~3.5t)	41 x 21	NISSAN (4t~) MITSUBISHI (2t~) ISUZU (4t~) HINO (4t~)

PW8P/4 4 Pieces Set/△=4,250g
CARDBOARD BOX:W240xH95xT70mm

Sockets

PW8P Impact Rear Wheel Nut Sockets
35x17, 38x20, 41x19, 41x21

PW8P (mmxmm)		D ₁ (mm)	D ₂ (mm)	H (mm)	L (mm)	(g)	Shaft Colour	(pcs.)	
35x17	1"	50	54	13	83	935		5	*1
38x20		55	54	14	83	1038	Red	5	*1
41x19		58	54	14	87	1100	Green	5	*1
41x21		58	54	14	87	1089	Yellow	5	*1

*1 C-Ring=1801C, Pin/O-Ring=1801A/B → P254-255

PW8L (mmxmm)		D ₁ (mm)	D ₂ (mm)	H (mm)	L (mm)	(g)	(pcs.)	
41x21	1"	58	54	15	105	1263	1	*1

*1 C-Ring=1801C, Pin/O-Ring=1801A/B → P254-255

PS6 (mm)		D ₁ (mm)	D ₂ (mm)	H (mm)	L (mm)	(g)	(pcs.)	
17	3/4"	40	44	19	53	433	5	*1
19		40	44	19	53	419	5	*1
20		44	44	21	55	483	5	*1
21		44	44	23	57	491	5	*1

*1 C-Ring=1600C, Pin/O-Ring=1601A/B → P254-255

PS8 (mm)		D ₁ (mm)	D ₂ (mm)	H (mm)	L (mm)	(g)	(pcs.)	
17	1"	40	54	19	60	621	2	*1
19		43	54	19	60	648	2	*1
20		45	54	21	62	687	2	*1
21		45	54	23	64	696	2	*1

*1 C-Ring=1801C, Pin/O-Ring=1801A/B → P254-255

PW6 PW8 Rear Wheel Nut Sockets
Vasos de Tuerca de Rueda Interna

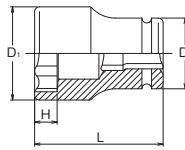

Tightening / Loosening Outer Nut

Tightening / Loosening Inner Nut

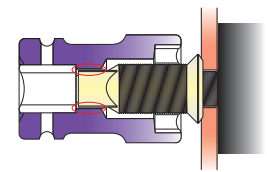
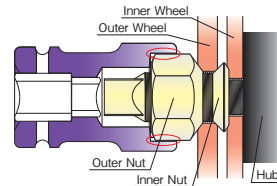

PW8P/4 PW8P Socket set of Rear Wheel Nut Sockets
Juego de Vasos de Tuerca de Rueda Interna
Rear Wheel Nut Sockets
Vasos de Tuerca de Rueda Interna



PW8L Rear Wheel Nut Socket (long)
Vasos de Tuerca de Rueda Interna (largos)

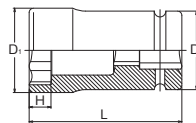

PS6 PS8 Rear Wheel Nut Sockets
Vasos de Tuerca de Rueda Interna

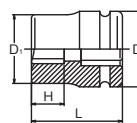

Z-SERIES
HAND
MANUALES
TITANIUM
DE TITANIO
ACCESSORIES
ACCESORIOS
DESTORNILLADORES
SCREWDRIVERS
DE IMPACTO
IMPACT
SLEEVE-DRIVE
INDUSTRIAL
INDUSTRIALES
PROTECTOR
PROTECTORES
AUTOMOTIVE
CONSTRUCTION
CONSTRUCCION
RENEWAL KITS
JUEGOS DE PIEZAS/REUESTO

Z-SERIES
HAND MANUALES
TITANIUM DE TITANIO
ACCESSORIES ACCESORIOS
SCREWDRIVERS DESTORNILLADORES
IMPACT DE IMPACTO
SLEEVE-DRIVE
INDUSTRIAL INDUSTRIALES
PROTECTOR PROTECTORES
AUTOMOTIVE
CONSTRUCTION CONSTRUCCIÓN
RENEWAL KITS JUEGOS DE PIEZAS REPUSTO

14466A-200B 14488A-B · -200B

Adaptors Adaptadores No Warranty Sin Garantía ⚠

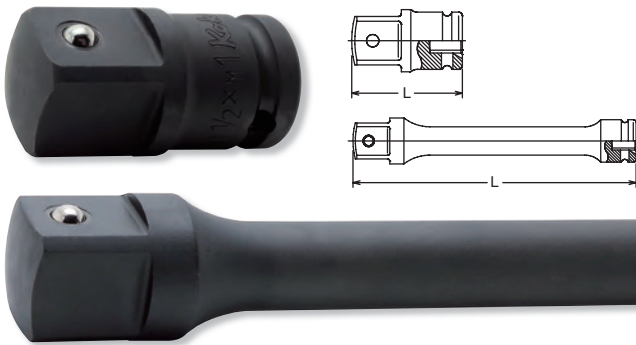

Adaptors	(sq)	(sq)	L (mm)	(g)	(pce.)	
14466A-200B	1/2"	3/4"	200	560	1	*2
14488A-B	1/2"	1"	58	280	1	*2
14488A-200B	1/2"	1"	200	660	1	*2

*2 C-Ring=1402C, Pin/O-Ring=1402A/B → P254-255

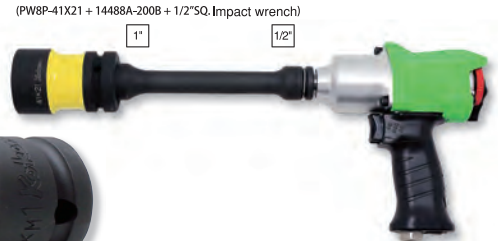

16316M · 16316A 18316M · 18316A

Rear Wheel Nut Sockets Vasos de Tuerca de Rueda Interna



16316M (mmxmm)		D ₁ (mm)	D ₂ (mm)	H (mm)	L (mm)	(g)	(pce.)	
35x17	3/4"	52	44	10	90	865	1	*1
38x20		56	44	13	100	952	1	*1
41x19		59	44	12	100	1037	1	*1
41x21		59	44	15	100	963	1	*1

*1 C-Ring=1600C, Pin/O-Ring=1601A/B → P254-255

16316A (inchxinch)		D ₁ (mm)	D ₂ (mm)	H (mm)	L (mm)	(g)	(pce.)	
1.1/2x13/16	3/4"	56	44	13	100	940	1	*1

*1 C-Ring=1600C, Pin/O-Ring=1601A/B → P254-255

16317M · 16317A 18317M · 18317A

Rear Wheel Nut Sockets Vasos de Tuerca de Rueda Interna



16317M (mm)		D ₁ (mm)	D ₂ (mm)	H (mm)	L (mm)	(g)	(pce.)	
17	3/4"	40	44	22.5	67	485	1	*1
19		40	44	22.5	67	462	1	*1
20		44	44	22.5	67	517	1	*1
21		44	44	22.5	67	489	1	*1
22		44	44	22.5	67	482	1	*1

*1 C-Ring=1600C, Pin/O-Ring=1601A/B → P254-255

16317A (inch)		D ₁ (mm)	D ₂ (mm)	H (mm)	L (mm)	(g)	(pce.)	
13/16	3/4"	44	44	22.5	67	489	1	*1

*1 C-Ring=1600C, Pin/O-Ring=1601A/B → P254-255

14466A-B / 14488A-B Impact Adaptors (1/2" SQ. → 3/4", 1" SQ.)

For temporary fastening a wheel nut socket for large vehicle with a light duty 1/2" SQ. DR. Impact wrench.

⚠ Socket is not completely locked with the Ball-type adaptor connection. Please beware of accidental socket release.

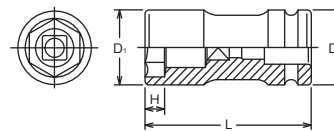

18316M (mmxmm)		D ₁ (mm)	D ₂ (mm)	H (mm)	L (mm)	(g)	(pce.)	
35x17	1"	52	54	10	108	1153	1	*1
38x20		56	54	13	108	1133	1	*1
41x19		59	54	12	108	1200	1	*1
41x21		59	54	15	108	1155	1	*1

*1 C-Ring=1801C, Pin/O-Ring=1801A/B → P254-255

18316A (inchxinch)		D ₁ (mm)	D ₂ (mm)	H (mm)	L (mm)	(g)	(pce.)	
1.1/2x13/16	1"	59	54	13	108	1120	1	*1

*1 C-Ring=1801C, Pin/O-Ring=1801A/B → P254-255

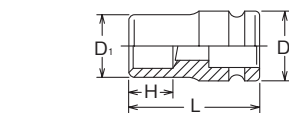

18317M (mm)		D ₁ (mm)	D ₂ (mm)	H (mm)	L (mm)	(g)	(pce.)	
17	1"	40	54	22.5	72	682	1	*1
17.5		40	54	22.5	72	677	1	*1
19		43	54	22.5	72	705	1	*1
20		45	54	22.5	72	723	1	*1
20.5		45	54	22.5	72	723	1	*1
21		45	54	22.5	72	703	1	*1
22		45	54	22.5	72	696	1	*1

*1 C-Ring=1801C, Pin/O-Ring=1801A/B → P254-255

18317A (inch)		D ₁ (mm)	D ₂ (mm)	H (mm)	L (mm)	(g)	(pce.)	
13/16	1"	45	54	22.5	72	703	1	*1

*1 C-Ring=1801C, Pin/O-Ring=1801A/B → P254-255

Construction



Z-SERIES
HAND MANUALES
TITANIUM DE TITANIO
ACCESSORIES ACCESORIOS
SCREWDRIVERS DESTORNILLADORES
IMPACT DE IMPACTO
SLEEVE-DRIVE
INDUSTRIAL INDUSTRIALES
PROTECTOR PROTECTORES
AUTOMOTIVE
CONSTRUCTION CONSTRUCCIÓN
RENEWAL KITS JUEGOS DE PIEZAS REPUESTO

BD014E  12-point Nut Setters, Deep
Vasos Bihex para Apretar Tuercas, largos

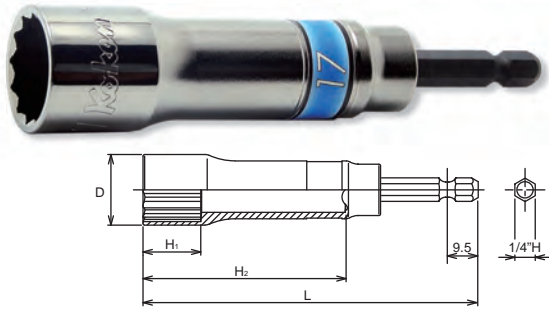

BD014E (mm)	D (mm)	H ₁ (mm)	H ₂ (mm)	L (mm)	(g)	(pcs.)
8	12	12	63	104	45	10
10	14	12	63	104	52	10
12	16.5	18	63	104	61	10
13	17.5	18	63	104	65	10
14	19	18	63	104	72	10
17	22.5	18	60	104	80	10
19	24.5	18	60	104	95	10
21	27	18	60	104	110	10
22	28	18	60	104	112	10
24	30.3	18	60	104	123	10

BD014SE  12-point Nut Setters
Vasos Bihex para Apretar Tuercas

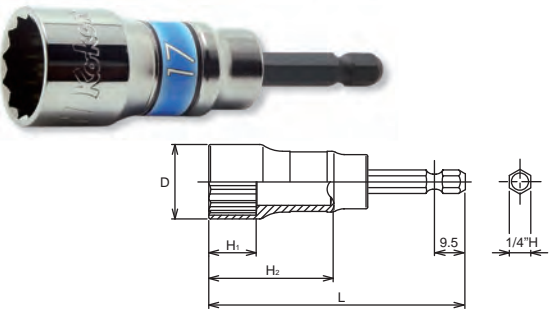

BD014SE (mm)	D (mm)	H ₁ (mm)	H ₂ (mm)	L (mm)	(g)	(pcs.)
8	12	12	36	77	35	10
10	14	12	36	77	38	10
12	16.5	14	36	77	48	10
13	17.5	14	36	77	51	10
14	19	14	36	77	54	10
17	22.5	14	36	77	76	10
19	24.5	14	36	77	83	10
21	27	14	34	77	104	10
22	28	14	34	77	120	10
24	30.3	14	34	77	140	10

BD008E-165 (12P)  12-point Nut Setters, Extra Long
Vasos Bihex para Apretar Tuercas

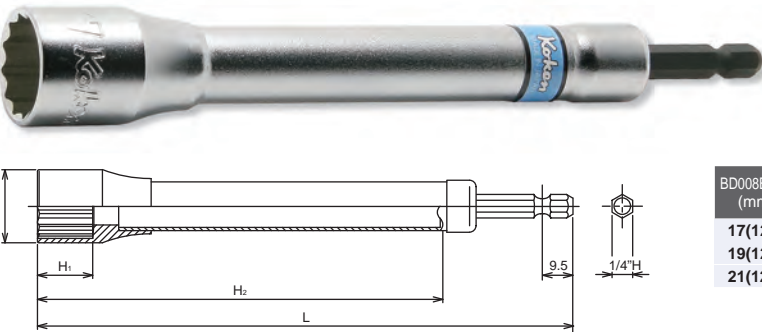

BD008E.165 (mm)	D (mm)	H ₁ (mm)	H ₂ (mm)	L (mm)	(g)	(pcs.)
17(12P)	22.5	17	110	165	105	10
19(12P)	24.5	17	110	165	135	10
21(12P)	27	17	110	165	142	10

BD008E-300 · -500 · -700 (12P)  12-point Nut Setters, Extra Long
Vasos Bihex para Apretar Tuercas

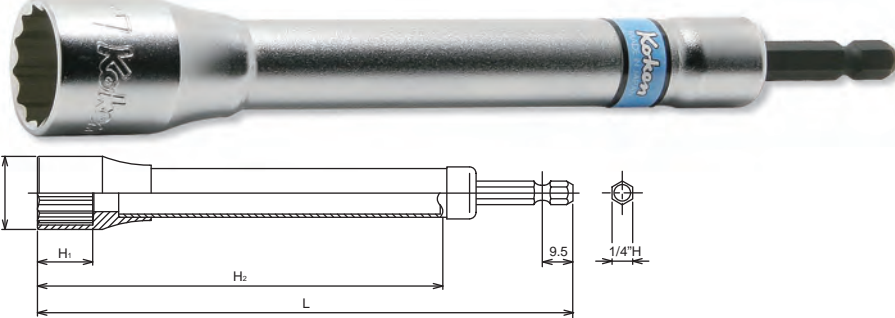

BD008E.300 (mm)	D (mm)	H ₁ (mm)	H ₂ (mm)	L (mm)	(g)	(pcs.)
17(12P)	22.5	17	245	300	154	2
19(12P)	24.8	17	245	300	204	2
21(12P)	27.3	17	245	300	214	2

BD008E.500 (mm)	D (mm)	H ₁ (mm)	H ₂ (mm)	L (mm)	(g)	(pcs.)
17(12P)	22.5	17	445	500	223	2
19(12P)	24.8	17	445	500	293	2

BD008E.700 (mm)	D (mm)	H ₁ (mm)	H ₂ (mm)	L (mm)	(g)	(pcs.)
17(12P)	22.5	17	645	700	292	2

BD014XE (mm)	D (mm)	H ₁ (mm)	H ₂ (mm)	L (mm)	(g)	(pcs.)
8SF	13	12	49	90	40	10
10SF	15	12	49	90	46	10
12SF	17.5	14	48	90	54	10
13SF	18.5	14	48	90	58	10
14SF	19.8	14	47	90	64	10
17SF	23.5	14	46	90	81	10
19SF	25.5	14	46	90	100	10
21SF	28	14	46	90	123	10
24SF	31.5	14	45	90	137	10

BD014E (mm)	D (mm)	H ₁ (mm)	H ₂ (mm)	L (mm)	(g)	(pcs.)
17SF	23.5	18	60	104	94	10
19SF	25.5	18	60	104	100	10
21SF	28	18	60	104	110	10

SURFACE DRIVE

Surface drive sockets are designed to retain contact with flat sides of nut to transmit high torque and reduce nut wear. These sockets are ideal for use on polished nuts, aluminum nuts and nuts with worn out points.

Los vasos de contacto curvo se diseñan para mantener el contacto con las caras planas de la tuerca y transmitir un alto par reduciendo el desgaste de la tuerca. Estos vasos son ideales para utilizarse en tuercas pulidas, tuercas de aluminio y tuercas con puntas gastadas

BD011SE (mm)	D (mm)	H ₁ (mm)	H ₂ (mm)	L (mm)	(g)	(pcs.)
10	14	12	35	100	73	10
12	16.5	12	35	100	77	10
13	17.5	12	35	100	79	10
14	19	12	32	100	82	10
17	22.5	14	32	100	87	10
19	24.5	14	30	100	94	10
21	27	14	30	100	103	10
22	28	14	30	100	104	10

BD014XE-SF Surface Drive Nut Setters, Semi-Deep Vasos semi-largos con Mango

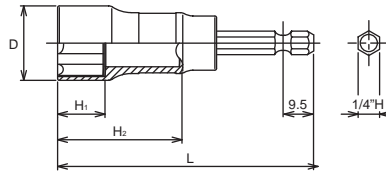

BD014E-SF Surface Drive Nut Setters Vasos con Mango

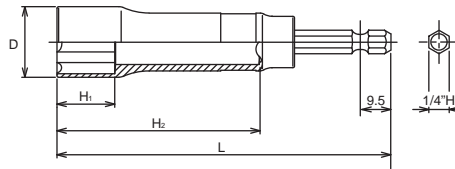

BD011SE 12-point Universal Joint Nut Setters Vasos Bihex para Apretar Tuercas con Articulación Universal

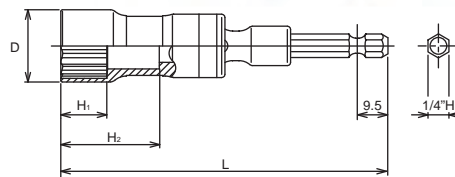

Colour Coded

Easy identification for the sizes.



Light Body Design

BD011SE, BD014E and BD014SE are designed 30% light weight for easy handling.

Dark Colour Chrome Plating

Surface treatment is Dark Colour Chrome Plating.
*except BD008E series

12 point Opening / Surface Drive Opening

Socket opening is designed to 12-point opening and surface drive opening to catch a bolt/nut easy.

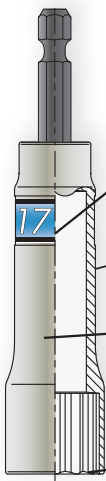

Z-SERIES
HAND
MANUALES
TITANIUM
DE TITANIO
ACCESSORIES
ACCESORIOS
SCREWDRIVERS
DESTORNILLADORES
IMPACT
DE IMPACTO
SLEEVE-DRIVE
INDUSTRIAL
INDUSTRIALES
PROTECTOR
PROTECTORES
AUTOMOTIVE
CONSTRUCTION
CONSTRUCCION
RENEWAL KITS
JUEGOS DE HERRAMIENTAS

Z-SERIES
HAND MANUALES
TITANIUM DE TITANIO
ACCESSORIES ACCESORIOS
SCREWDRIVERS DESTORNILLADORES
IMPACT DE IMPACTO
SLEEVE-DRIVE
INDUSTRIAL INDUSTRIALES
PROTECTOR PROTECTORES
AUTOMOTIVE
CONSTRUCTION CONSTRUCCION
RENEWAL KITS JUEGOS DE PIEZAS REPUESTO

BD003E-I

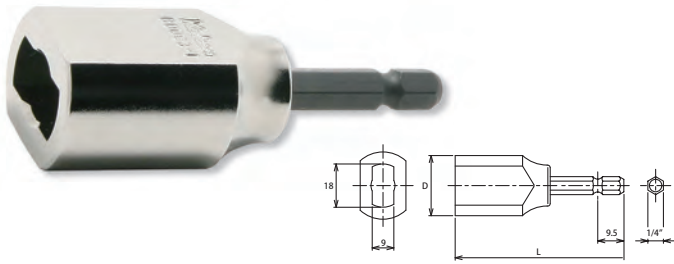

	D (mm)	L (mm)	(g)	(pcs.)
BD003E-I	25	70	95	10

BD013E

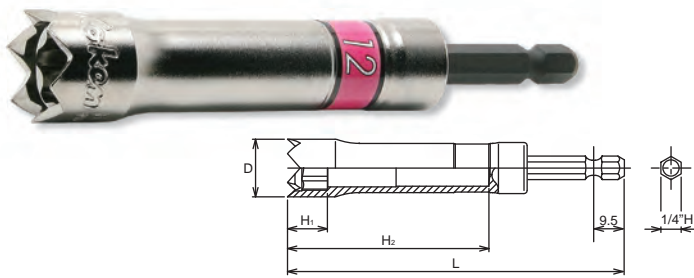

BD013E (mm)	D (mm)	H1 (mm)	H2 (mm)	L (mm)	(g)	(pcs.)
12	17.8	12.5	63	105	69	10

BD017E Wing Bolt Socket for Electric Drill Vaso para Tuerca de Orejetas para Taladro eléctrico

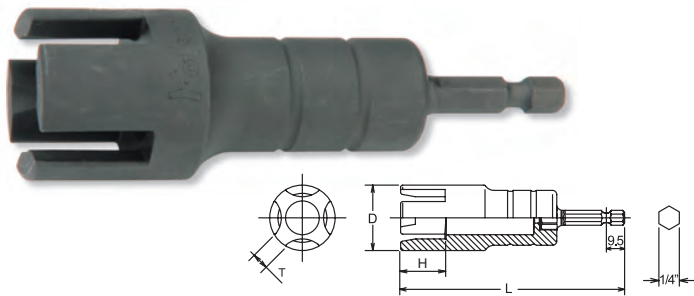

	D (mm)	T (mm)	H (mm)	L (mm)	(g)	(pcs.)
BD017E	31	7.3	21	104	158	10

BD018 Wing Bolt Socket Vaso para Tuerca de Orejetas

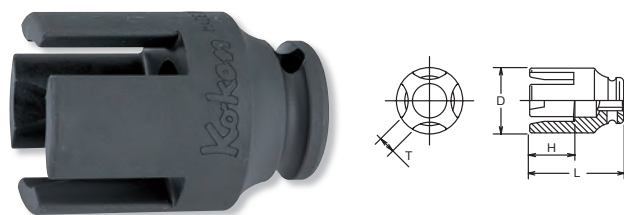

	D (mm)	T (mm)	H (mm)	L (mm)	(g)	(pcs.)	
BD018	31	7.3	21	45	113	10	*2

*2 C-Ring=1302C, Pin/O-Ring=1401A/B → P254-255

3119 Wing Bolt Socket Vaso para Tuerca de Orejetas

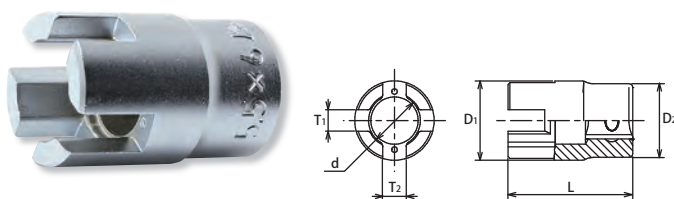

3119 (mm)	T1xT2 (mm)	D1 (mm)	D2 (mm)	d (mm)	L (mm)	(g)	(pcs.)
3 x5	3 x5	17	17.3	11	30	30	10
5.5x6	5.5x6	21	19.5	14	33	45	10



For Wing Bolt
Para Tuercas de Mariposa



For Drain Plug in Radiator
Para conectores de drenaje en Radiadores

BD023E		D (mm)	L (mm)	(g)	(pcs.)
3/8	3/8"	12.5	55	27	10
1/2	1/2"	16.5	60	48	10

BD024E		D (mm)	L (mm)	(g)	(pcs.)
3/8	3/8"	19.3	78	63	10
1/2	1/2"	19.3	82	73	10

BD030W		D (mm)	L (mm)	(g)	(pcs.)
1/2	1/2"	23	57	115	10

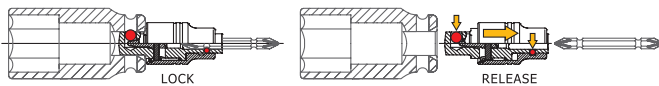

You may not hold the sliding part while moving to avoid heating up by friction and reduction by wear.

123PN.65 123PG.65 (PH)	D (mm)	L (mm)	(g)	(pcs.)
1	6.35	65	13	10
2	6.35	65	13	10
3	6.35	65	14	10

123PN.110 123PG.110 (PH)	D (mm)	L (mm)	(g)	(pcs.)
1	6.35	110	25	10
2	6.35	110	25	10
3	6.35	110	26	10

123PN.150 123PG.150 (PH)	D (mm)	L (mm)	(g)	(pcs.)
1	6.35	150	36	10
2	6.35	150	36	10
3	6.35	150	37	10

Groove position: Japanese model

184.64	D (mm)	H ₁ (mm)	H ₂ (mm)	L (mm)	(g)	(pcs.)
3/8x24UNF	12.5	14.5	13	64	34	10
1/2x20UNF	12.5	15.5	13	64	40	10

14184		D (mm)	H ₁ (mm)	H ₂ (mm)	L (mm)	(g)	(pcs.)	
3/8x24UNF	1/2"	25	14.5	22	44	85	10	*1
1/2x20UNF	1/2"	25	15.5	22	44	88	10	*1

*1 C-Ring=1401C, Pin/O-Ring=1401A/B P254-255

BD023E Adaptor
Adaptador



BD024E Universal Adaptors
Adaptadores Universal

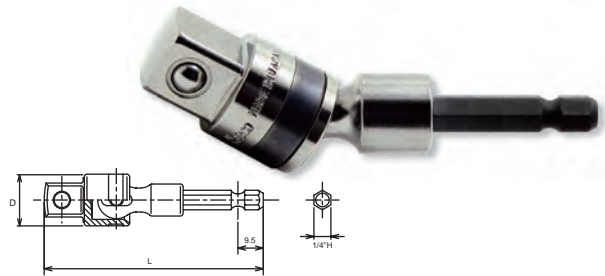

BD030W-1/2 Adaptor (Quick Release)
Adaptador (Extracción Rápida)

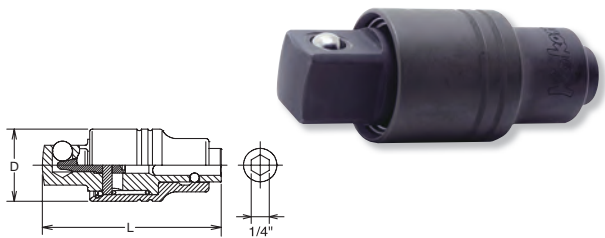

123PN-65 · -110 · -150 Double ended Bits
Puntas Phillips, simétricas

123PG-65 · -110 · -150 Magnetic type

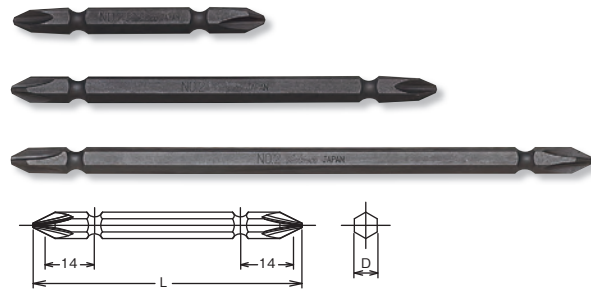

184.64 Drill Chuck Adaptor
Adaptador porta-brocas para Taladro

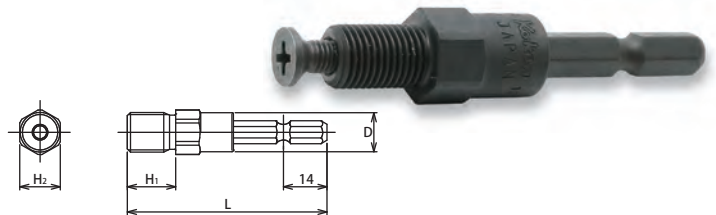

14184 Drill Chuck Adaptor
Adaptador porta-brocas para Taladro

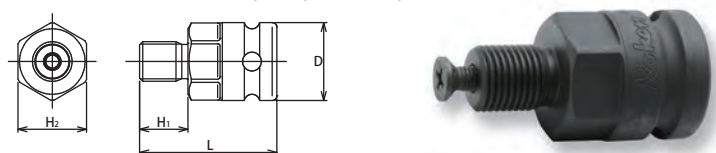

Z-SERIES
HAND
MANUALES
TITANIUM
DE TITANIO
ACCESSORIES
ACCESORIOS
SCREWDRIVERS
DESTORNILLADORES
IMPACT
DE IMPACTO
SLEEVE-DRIVE
INDUSTRIAL
INDUSTRIALES
PROTECTOR
PROTECTORES
AUTOMOTIVE
CONSTRUCTION
CONSTRUCCION
RENEWAL KITS
JUEGOS DE PIEZAS/REPUESTO

Z-SERIES
HAND
MANUALES
TITANIUM
DE TITANIO
ACCESSORIES
ACCESORIOS
SCREWDRIVERS
DESTORNILLADORES
IMPACT
DE IMPACTO
SLEEVE-DRIVE
INDUSTRIAL
INDUSTRIALES
PROTECTOR
PROTECTORES
AUTOMOTIVE
CONSTRUCTION
CONSTRUCCIÓN
RENEWAL KITS
JUEGOS DE PIEZAS REPUESTO

BD004 ○ Impact Screw and Stud Setters
Vasos de Impacto para Atornillar Pernos y Espárragos

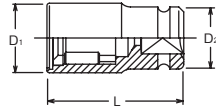

BD004 (mm)	□	D ₁ (mm)	D ₂ (mm)	L (mm)	⚖️ (g)	📦 (pcs.)	⚡
12.5x10	1/2"	30	25	70	236	5	*1
12.5x13		38	30	75	388	5	*2
12.5x16		38	30	75	369	5	*2
20 x19	3/4"	48	44	90	775	2	*3
20 x22		48	44	90	752	2	*3
20 x25		62	44	95	1184	2	*3
20 x29		62	44	95	1148	2	*3

*1 C-Ring=1401C, Pin/O-Ring=1401A/B
 *2 C-Ring=1402C, Pin/O-Ring=1402A/B → P254-255
 *3 C-Ring=1600C, Pin/O-Ring=1601A/B



162E ○ Stud Setters
Vasos de Atornillar Espárragos

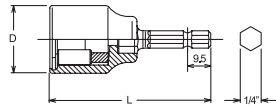

162E (mm)	D (mm)	L (mm)	⚖️ (g)	📦 (pcs.)
10	28	66	107	10

162E (inch)	D (mm)	L (mm)	⚖️ (g)	📦 (pcs.)
1/4	23	66	83	10
5/16	23	66	82	10
3/8	28	66	107	10
1/2	28	66	108	10

*Renewal Kits → 162RK → P307

142 ○ Stud Setters
Vasos de Atornillar Espárragos



142 (inch)	L (mm)	⚖️ (g)	📦 (pce.)
5/16	190	304	1
3/8	190	361	1
1/2	190	354	1

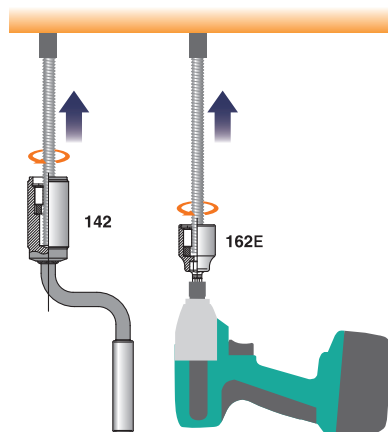

141S (mm)	D (mm)	L (mm)	(g)	(pce.)
6	28	120	150	1
8	28	120	150	1
10	32	120	153	1
12	32	120	152	1

141S (inch)	D (mm)	L (mm)	(g)	(pce.)
5/16	28	120	150	1
3/8	32	120	153	1
1/2	32	120	152	1

141S Stud Puller Ratchets
Extractores de Espárragos de Carraca

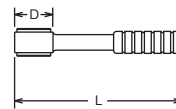
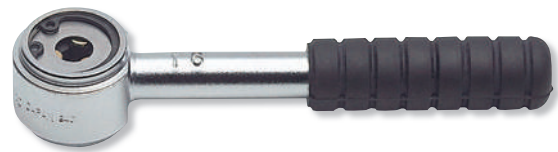

141 Stud Puller Ratchets
Extractores de Espárragos de Carraca

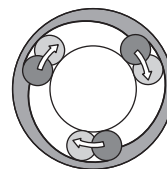

Stud Puller Ratchet (141S/141/141P)
The three roller system can protect the studs from damage.

El sistema de tres rodillos puede proteger los espárragos de cualquier daño

141 (mm)	D (mm)	L (mm)	(g)	(pce.)
6	28	205	215	1
8	28	205	215	1
10	32	205	234	1
12	32	205	233	1

141 (inch)	D (mm)	L (mm)	(g)	(pce.)
5/16	28	205	215	1
3/8	32	205	234	1
1/2	32	205	233	1

141P Stud Puller Ratchets
Extractores de Espárragos de Carraca

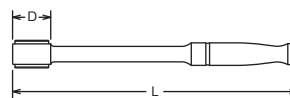

141P (mm)	D (mm)	L (mm)	(g)	(pce.)
6	28	205	210	1
8	28	205	210	1
10	32	205	229	1
12	32	205	227	1

1201 4 Pieces Set/△=973g

METAL CASE:W240xH100xT32mm

Pullers

141S Stud Puller Ratchets
6, 8, 10, 12



1201 Stud Puller Ratchets Set
Juego de Extractores de Espárragos de Carraca





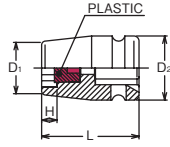

Z-SERIES
HAND
MANUALES
TITANIUM
DE TITANIO
ACCESSORIES
ACCESORIOS
SCREWDRIVERS
DESTORNILLADORES
IMPACT
DE IMPACTO
SLEEVE-DRIVE
INDUSTRIAL
INDUSTRIALES
PROTECTOR
PROTECTORES
AUTOMOTIVE
CONSTRUCTION
CONSTRUCCION
RENEWAL KITS
JUEGOS DE PIEZAS/REPOSTO

Z-SERIES
HAND MANUALES
TITANIUM DE TITANIO
ACCESSORIES ACCESORIOS
SCREWDRIVERS DESTORNILLADORES
IMPACT DE IMPACTO
SLEEVE-DRIVE
INDUSTRIAL INDUSTRIALES
PROTECTOR PROTECTORES
AUTOMOTIVE
CONSTRUCTION CONSTRUCCIÓN
RENEWAL KITS JUEGOS DE PIEZAS REPUESTO

BD14400MJ  6-point Sockets for Anchor Screws
Vasos Hexagonales para Pernos de Anclaje





BD14400MJ (mm)		D ₁ (mm)	D ₂ (mm)	H (mm)	L (mm)	 (g)	 (pcs.)	
13		20.7	25	5	38	140	10	*1
15		23.2	30	5	38	145	10	*2
17		25.7	30	6.5	38	145	10	*2
19		28.2	30	7.5	38	145	10	*2

*1 C-Ring=1401C, Pin/O-Ring=1401A/B
*2 C-Ring=1402C, Pin/O-Ring=1402A/B → P254-255

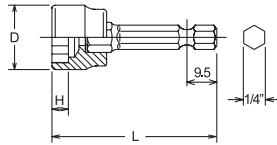

BD016E  6-point Sockets for Anchor Screws
Vasos Hexagonales para Pernos de Anclaje

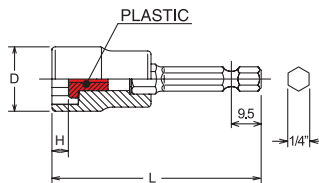

BD016E (mm)	D (mm)	H (mm)	L (mm)	 (g)	 (pcs.)
13	19.5	4	50	43	10
17	24.5	5	50	56	10
19	27	6	50	68	10

BD016JE  6-point Sockets for Anchor Screws
Vasos Hexagonales para Pernos de Anclaje



BD016JE (mm)	D (mm)	H (mm)	L (mm)	 (g)	 (pcs.)
13	19.5	5	60	66	10
17	24.5	6.5	60	80	10
19	27	7.5	60	90	10

HA001	D (mm)	H (mm)	L (mm)	(g)	(pcs.)
10(1.5)	15.5	13	47	90	10
12(1.25)	17.2	15	49	100	10
16(2.0)	21	18	52	125	10
20(2.5)	24.5	21	56	155	10
22(2.5)	26.5	27	61	175	10
24(3.0)	28	28	62	185	10

HA001 Stud Setters
Vasos para Atornillar Espárragos

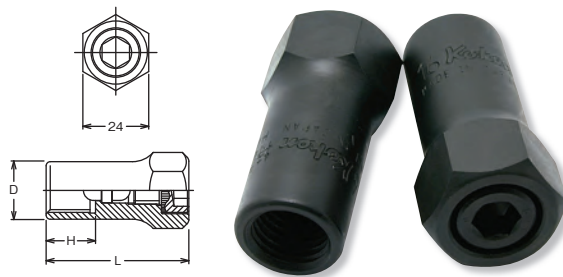

HA002.130 (mm)	D (mm)	H (mm)	L (mm)	(g)	(pcs.)
24	34.5	14	130	246	10

HA002.160 (mm)	D (mm)	H (mm)	L (mm)	(g)	(pcs.)
24	34.5	14	160	465	10

HA002-130 · -160 Socket for HA001
Vaso para HA001

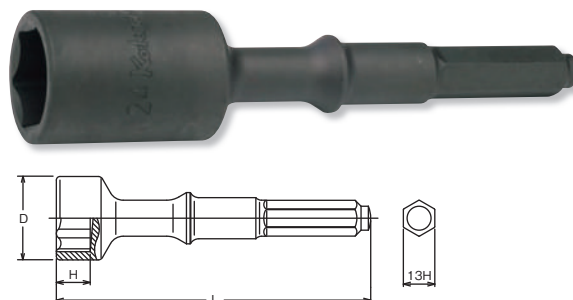

HA003.100 (mm)	D (mm)	H (mm)	L (mm)	(g)	(pcs.)
24	34.5	14	100	155	10

HA003-100 Socket for HA001
Vaso para HA001

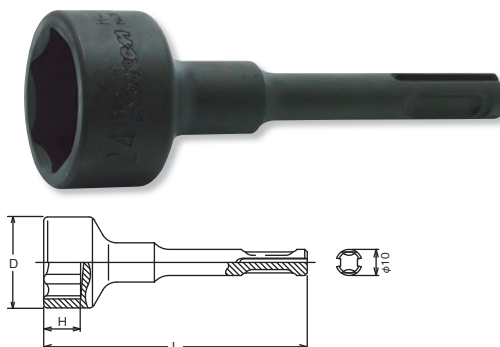

HA004 (mm)	D (mm)	H (mm)	L (mm)	(g)	(pcs.)
24	31	16.5	58	91	10

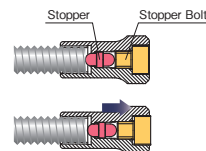
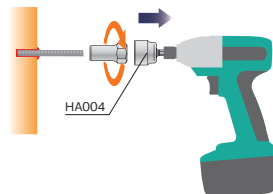
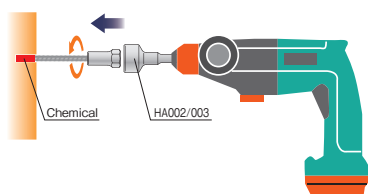
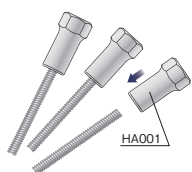
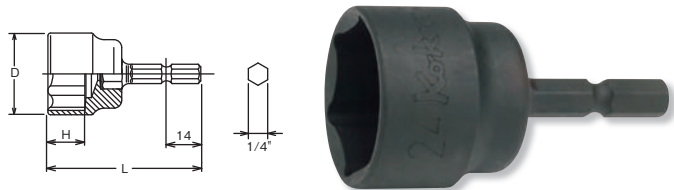

HA004



Z-SERIES
HAND
MANUALES
TITANIUM
DE TITANIO
ACCESSORIES
ACCESORIOS
SCREWDRIVERS
DESTORNILLADORES
IMPACT
DE IMPACTO
SLEEVE-DRIVE
INDUSTRIAL
INDUSTRIALES
PROTECTOR
PROTECTORES
AUTOMOTIVE
CONSTRUCTION
CONSTRUCCION
RENEWAL KITS
JUEGOS DE REPARACION

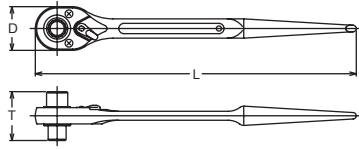

170S  Spud Handle Ratchets
Llaves de Carraca con Mango de Cola



170S (mm)	D (mm)	T (mm)	L (mm)	 (g)	 (pce.)
10x12	34	38	250	260	1
10x13	34	38	250	260	1
10x14	34	38	250	260	1
11x13	34	38	250	260	1
12x14	34	38	250	260	1

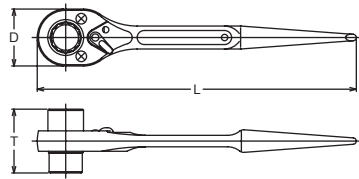

171S  Spud Handle Ratchets(Short)
Llaves de Carraca con Mango de Cola(Cortas)

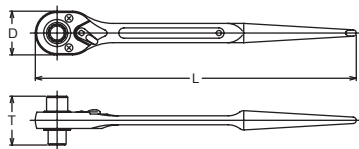

171S (mm)	D (mm)	T (mm)	L (mm)	 (g)	 (pce.)
13x17	44.6	50	250	460	1
14x17	44.6	50	250	460	1
17x19	44.6	50	250	460	1
17x21	44.6	50	250	460	1
17x22	44.6	50	250	460	1
19x21	44.6	50	250	460	1
19x22	44.6	50	250	460	1

171  Spud Handle Ratchets(Long)
Llaves de Carraca con Mango de Cola(Largas)



171 (mm)	D (mm)	T (mm)	L (mm)	 (g)	 (pce.)
13x17	44.6	50	380	630	1
14x17	44.6	50	380	630	1
17x19	44.6	50	380	630	1
17x21	44.6	50	380	630	1
17x22	44.6	50	380	630	1
19x21	44.6	50	380	630	1
19x22	44.6	50	380	630	1

172  Spud Handle Ratchets
Llaves de Carraca con Mango de Cola



172 (mm)	D (mm)	T (mm)	L (mm)	(g)	(pce.)
19x24	68	58	380	1100	1
21x26	68	58	380	1100	1
22x24	68	58	380	1100	1
23x26	68	58	380	1100	1
24x27	68	58	380	1100	1
24x30	68	58	380	1100	1
26x32	68	63	380	1100	1
27x32	68	58	380	1100	1
30x32	68	58	380	1100	1

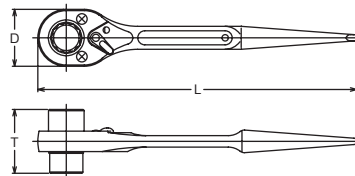

171SB-1/2 Spud Handle Ratchet with Push Button(short)
Llave de Carraca con Mango de Cola con Botón(corta)



		D (mm)	T (mm)	L (mm)	(g)	(pce.)
171SB-1/2	1/2"	44.6	33	250	480	1

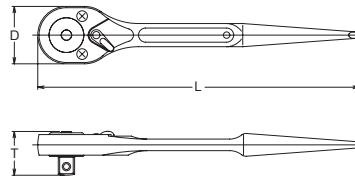

171B-1/2 Spud Handle Ratchet with Push Button(Long)
Llave de Carraca con Mango de Cola con Botón(larga)



		D (mm)	T (mm)	L (mm)	(g)	(pce.)
171B-1/2	1/2"	44.6	33	380	650	1

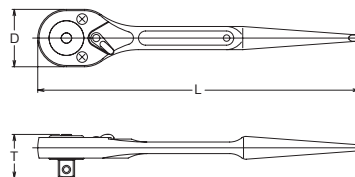

Z-SERIES
HAND
MANUALES
TITANIUM
DE TITANIO
ACCESSORIES
ACCESORIOS
SCREWDRIVERS
DESTORNILLADORES
IMPACT
DE IMPACTO
SLEEVE-DRIVE
INDUSTRIAL
INDUSTRIALES
PROTECTOR
PROTECTORES
AUTOMOTIVE
CONSTRUCTION
CONSTRUCCION
RENEWAL KITS
JUEGOS DE PIEZAS REPUESTO



Ko-ken welcomes customer enquiries for special tools. New items can be designed and manufactured according to customers requirements. Please enquire through your distributors.

Ko-ken da la bienvenida a todas las solicitudes por herramientas especiales de nuestros clientes. Productos nuevos pueden ser diseñados y fabricados de acuerdo a sus necesidades. Por favor haga su solicitud a través nuestra red de distribuidores.

Renewal Kits



Renewal Kits

Z-SERIES
HAND MANUALES
TITANIUM DE TITANIO
ACCESSORIES ACCESORIOS
SCREWDRIVERS DESTORNILLADORES
IMPACT DE IMPACTO
SLEEVE-DRIVE
INDUSTRIAL INDUSTRIALES
PROTECTOR PROTECTORES
AUTOMOTIVE
CONSTRUCTION CONSTRUCCIÓN
RENEWAL KITS JUEGOS DE PIEZAS REPUESTO

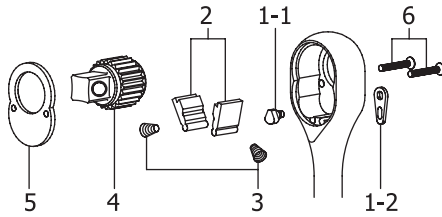
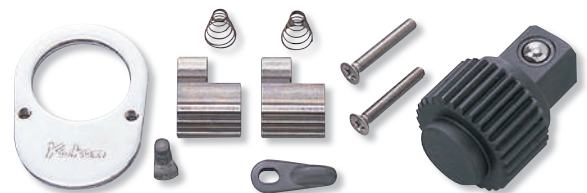
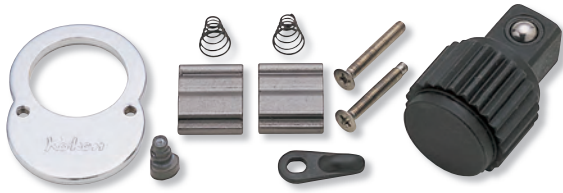

- 1-1 Reversion Cam
- 1-2 Reversion Lever
- 2 Dog
- 3 Spring
- 4 Square Drive
- 5 Cover plate
- 6 Screw

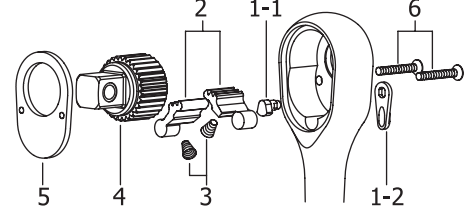

- 1-1 Reversion Cam
- 1-2 Reversion Lever
- 2 Dog
- 3 Spring
- 4 Square Drive
- 5 Cover plate
- 6 Screw

	▣	Products	(g)	(pce.)
2749RK	1/4"	2749N/P/J	30	1
2753RK		2753N/P/J, 2753PS/PSKR, 2753P-160, 2774PS/JS, 2774N/P/J	30	1
2753BRK		2753NB/PB/JB	31	1
2749RK-3/8	3/8"	2749PS-3/8, 2749N-3/8, 2749P-3/8, 2774PS-3/8, 2774JS-3/8	45	1
3749RK		3749S, 3749N	70	1
3749BRK	1/2"	3749SB	84	1
3753RK		3753N/P/J, 3753SM, 3753P-250, 3774N/P/J, 2774PS, 3774NL/PL/JL	84	1
3753BRK		3753NB/PB/JB, 3753SMB, 3774NB/PB/JB/JBL	76	1
3749SRK-1/2	1/2"	3749S-1/2	120	1
3749SBRK-1/2		3749SB-1/2	120	1
4749RK	3/4"	4749N-250, 4749N-380, 4749J-380	130	1
4753RK		4753N/P/J, 4753P-410, 4774N/P/J, 4774P-450	130	1
4753BRK		4753NB/PB/JB, 4774NB/PB/JB	130	1
6749RK	1"	6749, 6749-1000	580	1
8749RK	1"	8749, 8749-1000	800	1

	▣	Products	(g)	(pce.)
4750RK	1/2"	4750N/P/J	130	1
4750BRK		4750NB/PB/JB	130	1

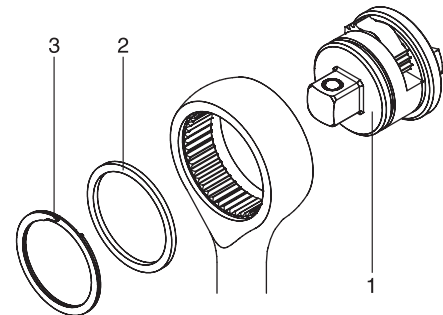

- 1 Head
- 2 Ring
- 3 Retaining Ring

	▣	Products	(g)	(pce.)
2752RK	1/4"	2752N	42	1

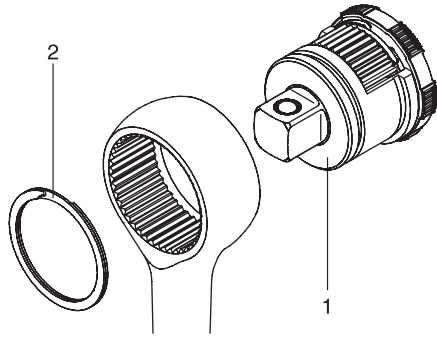

- 1 Head
- 2 Retaining Ring

	□	Products	(g)	(pce.)
3752RK	3/8"	3752N/J, 3757, 3776N/P/J	84	1
4752RK	1/2"	4752N/J	140	1

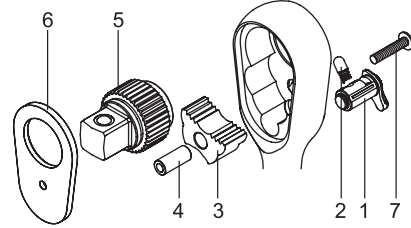

- 1 Reversion Lever
- 2 Pin+Spring
- 3 Pawl
- 4 Sleeve
- 5 Square Drive
- 6 Cover Plate
- 7 Screw

	□	Products	(g)	(pce.)
2725RK	1/4"	2725Z, 2725Z-160, 2726Z, 2726Z-160	30	1
2725RK-3/8	3/8"	2725Z-3/8, 2725Z-3/8(L160), 2726Z-3/8, 2726Z-3/8(L160)	45	1
3725RK	3/8"	3725Z, 3725ZS, 3725Z-280, 3726Z, 3726ZS, 3726Z-280	50	1
4725RK	1/2"	4725Z	120	1

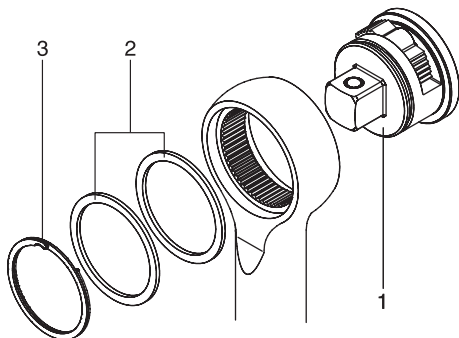

- 1 Head
- 2 Ring
- 3 Retaining Ring

	□	Products	(g)	(pce.)
6752RK	3/4"	6752	600	1



TORXPLUS® 6IP Screwdriver for 2725RK
 TORXPLUS® 8IP Screwdriver for 3725RK
 TORXPLUS® 10IP Screwdriver for 4725RK

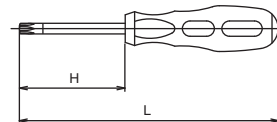

168T (IP)	H (mm)	L (mm)	(g)	(pce.)
6IP(40)	40	110	20	1
8IP(40)	40	110	20	1
10IP(40)	40	110	22	1

Z-SERIES
 HAND
 MANUALES
 DE TITANIO
 TITANIUM
 ACCESORIES
 ACCESORIOS
 DESTORNILLADORES
 SCREWDRIVERS
 DE IMPACTO
 IMPACT
 SLEEVE-DRIVE
 INDUSTRIAL
 INDUSTRIALES
 PROTECTOR
 PROTECTORES
 AUTOMOTIVE
 CONSTRUCTION
 CONSTRUCCION
 RENEWAL KITS
 JIFESOS DE HEZAS-REPUESTO

Renewal Kits

Z-SERIES
HAND MANUALES
TITANIUM DE TITANIO
ACCESSORIES ACCESORIOS
SCREWDRIVERS DESTORNILLADORES
IMPACT DE IMPACTO
SLEEVE-DRIVE
INDUSTRIAL INDUSTRIALES
PROTECTOR PROTECTORES
AUTOMOTIVE
CONSTRUCTION CONSTRUCCIÓN
RENEWAL KITS JUEGOS DE PIEZAS REPUESTO

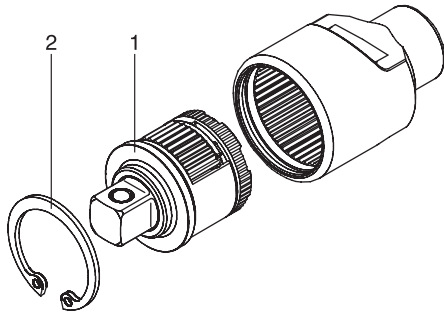

- 1 Head
- 2 Retaining Ring

	□	Products	(g)	(pce.)
2755RK	1/4"	2755	40	1
3755RK	3/8"	3755	98	1
4755RK	1/2"	4755	137	1
6755RK	3/4"	6755	550	1

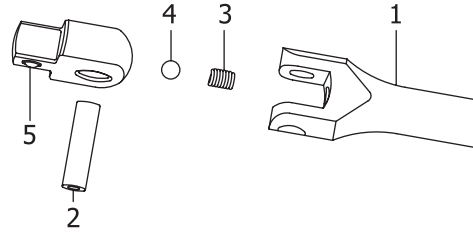

- 1 Body
- 2 Pin
- 3 Coil Spring
- 4 Ball
- 5 Square Drive

	□	Products	(g)	(pce.)
2768RK	1/4"	2768N/P/J	40	1
6768RK	3/4"	6768, 6768-600, 6768-1000	98	1
8768RK	1"	8768, 8768-1000	137	1

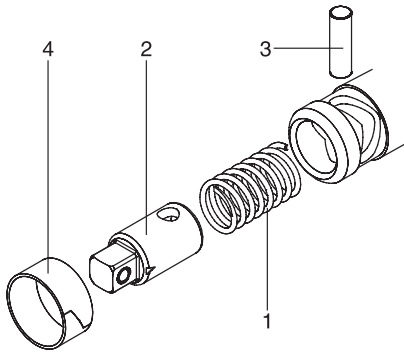

- 1 Spring
- 2 Square Drive
- 3 Pin
- 4 Retaining Ring

	□	Products	(g)	(pce.)
3112RK	3/8"	3112N/J	106	1
4112RK	1/2"	4112N/J	116	1
6112RK	3/4"	6112	445	1

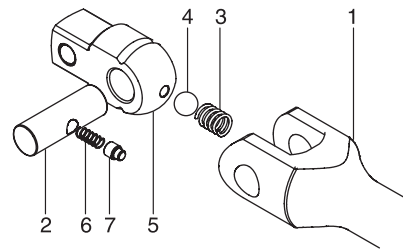

- 1 Body
- 2 Pin
- 3 Coil Spring
- 4 Ball
- 5 Square Drive
- 6 Coil Spring
- 7 Plunger



	□	Products	(g)	(pce.)
3768RK	3/8"	3768N-175/250/300, 3768P-250/380, 3768J-250	40	1
3768ZRK	3/8"	3768Z-250/400	40	1
4768RK	1/2"	4768N-300/380/450/600, 4768N-380/450/600, 4768J-380/450/600, 4781N-450	137	1
4768ZRK	1/2"	4768Z-430	137	1

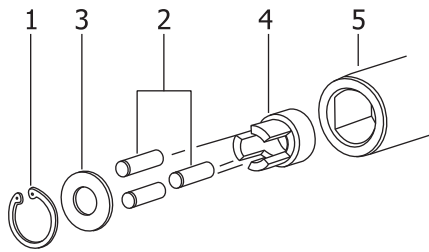

- 1 Retaining Ring
- 2 Roller
- 3 Cover
- 4 Cage
- 5 Body

4100MRK (mm)	□	Products	Ⓢ (pce.)
6	1/2"	4100M-6	1
7		4100M-7	1
8		4100M-8	1
9		4100M-9	1
10		4100M-10	1
10.5		4100M-10.5	1
11		4100M-11	1
12		4100M-12	1
14		4100M-14	1
16		4100M-16	1

4100ARK (inch)	□	Products	Ⓢ (pce.)
1/4	1/2"	4100A-1/4	1
5/16		4100A-5/16	1
3/8		4100A-3/8	1
7/16		4100A-7/16	1
1/2		4100A-1/2	1
9/16		4100A-9/16	1
5/8		4100A-5/8	1

6100MRK (mm)	□	Products	Ⓢ (pce.)
18	3/4"	6100M-18	1
20		6100M-20	1
22		6100M-22	1
24		6100M-24	1
27		6100M-27	1
28		6100M-28	1
29		6100M-29	1
30		6100M-30	1

162RK	Products	Ⓢ (pce.)
5/16	162N-5/16	1
3/8	162N-3/8	1
1/2	162N-1/2	1
10	162N-10	1

Z-SERIES
HAND
MANUALES
TITANIUM
DE TITANIO
ACCESSORIES
ACCESORIOS
SCREWDRIVERS
DESTORNILLADORES
IMPACT
DE IMPACTO
SLEEVE-DRIVE
INDUSTRIAL
INDUSTRIALES
PROTECTOR
PROTECTORES
AUTOMOTIVE
CONSTRUCTION
CONSTRUCCION
RENEWAL KITS
JIFGOS DE PIEZAS REPUESTO

HAND SOCKETS / Diameter of Bore

Standard Socket



Deep Socket

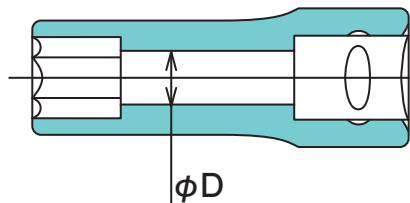
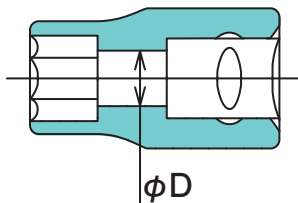

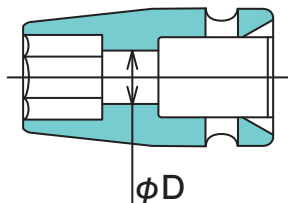

SOCKET		1/4" O		3/8" O		1/2" O		3/4" O		1" O
		Standard	Deep	Standard	Deep	Standard	Deep	Standard	Deep	Standard
		2400M 2400A	2300M 2300A	3400M 3400A	3300M 3300A	4400M 4400A	4300M 4300A	6400M 6400A	6300M 6300A	8400M 8400A
		2405M 2405A	2305M 2305A	3405M 3405A	3305M 3305A	4405M 4405A	4305M 4305A	6405M 6405A	6305M 6305A	8405M 8405A
(mm)	(inch)	ϕD								
3	1/8	2.5	2.5							
4		3	3							
4.5		3.5	3.5							
5	3/16	4	4							
5.5	7/32	4.5	4.5	4.5	4.5					
6	1/4	4.5	5	5	5					
7	9/32	6.2	6	5.5	6					
8	5/16	6.2	7	6	7	6	7			
9	11/32	8.3	8.3	7	8	7	8			
10	3/8	9.4	9	8	9	8	9			
11	7/16	10	10	9	10	9	10			
12		10	11	10	11	10	11			
13	1/2	11.5	12	11	12	11	12			
14	9/16	13	13	13.5	13.5	12	13			
15	19/32			13	14	13	14			
16	5/8			14	15	14	15			
17	21/32			15	16	15	16	15	16	
18	11/16			15	17	15	17	15	17	
19	3/4			16	18	18	18	16	18	
20	25/32			17	19	18	19	17	19	
21	13/16			18	20	18	20	18	20	
22	7/8			19	21	19	21	19	21	
23				20	22	20	22	20	22	
24	15/16			21	23	21	23	21	23	
25				22	24	22	24	22	24	
26	1			23	25	23	25	23	25	
27	1- 1/16				26	23	26	23	26	23
28						24	27	24	27	24
29	1- 1/8					24	28	24	28	24
30	1- 3/16					25	29	25	29	25
31						26	30	26	30	26
32	1- 1/4					27	31	27	31	27
33	1- 5/16					28	32	28	32	28
34						29	33	29	33	29
35	1- 3/8					30	34	30	34	30
36						31	35	31	35	31
37	1- 7/16					31	36	31	36	31
38	1- 1/2					32	37	32	37	32
39								32	38	32
40	1- 9/16							33	39	33
41	1- 5/8							34	40	34
42								34	41	34
43	1-11/16							35	42	35
44	1- 3/4							36	43	36
45								36	44	36
46	1-13/16							37	45	37
47								38	46	38
48	1- 7/8							38	47	38
	1-15/16							39	48	39
50	2							40	49	40
	2- 1/16							40		

Standard Socket

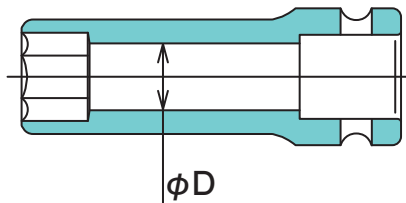

Deep Socket



SOCKET		1/4" \square		3/8" \square		1/2" \square		3/4" \square		1" \square	
		Standard	Standard	Deep	Standard	Deep	Standard	Deep	Standard	Deep	
		12400M 12400A	13400M 13400A	13300M 13300A	14400M 14400A	14300M 14300A	16400M 16400A	16300M 16300A	18400M 18400A	18300M 18300A	
(mm)	(inch)	ϕD									
4		3									
4.5	3/16	3									
5		4									
5.5		4									
6	1/4	5	5	5							
7	9/32	5	5	6							
8	5/16	6	6	7	6	7					
9	11/32	7	7	8	7	8					
10	3/8	8	8	9	8	9					
11	7/16	9	9	10	9	10					
12		10	10	11	10	11					
13	1/2	11	11	12	11	12					
14	9/16	12	12	13	12	13					
15			13	14	13	14					
16	5/8		14	15	14	15	14	15			
17	11/16		14	16	14	16	14	16			
18			15	17	15	17	15	17			
19	3/4		16	18	16	18	16	18	16	18	
20			17	19	17	19	17	19	17	19	
21	13/16		18	20	18	20	18	20	18	20	
22	7/8		19	21	19	21	19	21	19	21	
23			20		20	22	20	22	20	22	
24	15/16		20		21	23	21	23	21	23	
25	1				22	24	22	24	22	24	
26					23	25	23	25	23	25	
27	1- 1/16				23	26	23	26	23	26	
28					23	27	24	27	24	27	
29	1- 1/8				23	28	25	28	25	28	
30	1- 3/16				23	29	26	29	26	29	
31					23	30	27	30	27	30	
32	1- 1/4				23	31	28	31	28	31	
33					25	32	29	32	29	32	
34	1- 5/16				25	33	30	33	30	33	
35	1- 3/8				25	34	31	34	31	34	
36					28	35	32	35	32	35	
37	1- 7/16						32	36	32	36	
38	1- 1/2						34	37	34	37	
40	1- 9/16						34	39	34	39	
41	1- 5/8						35	40	35	40	
42	1-11/16						35	41	35	41	
45	1- 3/4						35	44	35	44	
46	1-13/16						40	45	40	45	
47							40	46			
	1- 7/8						40	47			

Screw dimension	Hexagon Head Bolt			Hexagon Socket Head Cap Screws			TORX		TORXPLUS		Triple Square	LHSTIX	Ref.) Standard Tightning Torque (Nm)				
	Standard	Compact	High Strength	Standard	Button Head / Shoulder Head	Hexagon Socket Set Screws	T	E	IP	EP [EPL]	XZN	LH-S [LH-SS]	Grade 4.6	Grade 6.8	Grade 8.8	Grade 10.9	Grade 12.9
M2	4			1.5		0.9	T6/T8		6IP				0.12	0.24	0.32	0.45	0.54
M2.5	5			2		1.3	T8		8IP		M3		0.25	0.49	0.65	0.92	1.1
M3	5.5			2.5	2	1.5	T10	E4	8IP/10IP	4EP	M3		0.43	0.87	1.16	1.63	1.96
M3.5	(6)						T15		10IP/15IP				0.68	1.37	1.82	2.56	3.08
M4	7			3	2.5	2	T20/T25	E5	15IP/20IP	5EP	M4	LH4S	1.01	2.02	2.7	3.79	4.54
M5	8			4	3	2.5	T25/T27	E6	20IP/25IP /27IP	6EP [8EPL]	M5	LH5S	2.04	4.09	5.47	7.67	9.18
M6	10			5	4	3	T30	E8	27IP/30IP	8EP [10EPL]	M6	LH6S	3.47	6.97	9.27	13	15.6
M7	11						T40	E8	40IP	8EP [12EPL]			5.85	11.6	15.5	21.8	26.2
M8	13	(12)		6	5	4	T40/T45	E10	40IP/45IP	10EP [14EPL]	M8	LH8S	8.41	16.9	22.5	31.6	37.9
M10	16 (17)	(14)		8	6	5	T50	E12	45IP/50IP	12EP [16EPL]	M10	LH10S [LH8SS]	16.7	33.4	44.5	62.6	75.2
M12	18 (19)	(17)	21 (22)	10	8	6	T55	E14	55IP	14EP [20EPL]	M12	LH12S [LH10SS]	29.1	58.3	77.6	109	131
M14	21 (22)	(19)		12			T55/T60	E14/E18	55IP/60IP	18EP [24EPL]	M14	LH14S [LH12SS]	46.4	92.7	124	174	209
M16	24	(22)	27	14	10	8	T60/T70	E16/E20	60IP/70IP	20EP [26EPL]	M16	LH16S [LH14SS]	72.3	145	194	271	325
M18	27	(24)		(14)			T70/T80	E24	80IP	24EP [30EPL]	M18		100	199	266	373	447
M20	30 (32)	(27/29)	32	17	12	10	T80/T90	E24	90IP	24EP [32EPL]			141	282	376	529	635
M22	34 (32/35)	(30/32)	36	(17)			T90/T100	E28	100IP	24EP [36EPL]			192	384	511	720	865
M24	36 (38)	(32/35)	41	19		12	T100	E32	100IP	32EP [40EPL]			244	488	650	915	1100
M27	41	(36)	46	(19)						32EP			358	713	951	1340	1610
M30	46	(41)	50	22						36EP			484	971	1290	1820	2180
M33	50	(46)		(24)						40EP			661	1320	1760	2470	2970
M36	55 (54)	(50)		27						44EP			848	1690	2260	3180	3810
M39	60 (58)	(55)		(27)									1100	2190	2920	4110	4930
M42	65 (63)			32									1350	2710	3610	5080	6080
M45	70 (67)			(32)									1700	3400	4540	6370	7630
M48	75 (71)			36									2030	4060	5440	7620	9120
M52	80 (77)			(36)									2640	5290	7040	9880	11800
M56	85			41									3270	6560	8710	12300	14800
M60	90												4080	8180	10900	15300	18300
M64	95			46									4930	9890	13100	18500	22300
M68	(100)												5970	12000	16000	22500	27000

*Reference: Hexagon Head Bolt: ISO 4014-4018, 8676, 8768
 High Strength Hexagon Bolt: JIS B 1196
 Hexagon Socket Head Cap Screws: ISO 7380
 Hexagon Socket Button Head Screws: ISO 7380
 Hexagon Socket Set Screws: ISO 4026-4029
 TORX T/E: TORX Standard TMH series
 TORXPLUS IP/EP: TORXPLUS Standard CMH series
 Triple Square: DIN 2324/2325
 LHSTIX LH-S/SS: LH-S/SS Standard

* Standard Tightening Torque: Calculated based on Torque Coefficient (K): 0.2
 Axial Force (Ff) : 60% of Proof Strength(σ)

TORX® / TORXplus® BITS

		S1 (mm)	S2 (mm)
T6	6IP	1.7	1.2
T7	7IP	2.0	1.4
T8	8IP	2.3	1.7
T9	9IP	2.5	1.8
T10	10IP	2.7	2.0
T15	15IP	3.3	2.3
T20	20IP	3.9	2.8
T25	25IP	4.5	3.2
T27	27IP	5.0	3.6
T30	30IP	5.6	4.0
T40	40IP	6.7	4.8
T45	45IP	7.9	5.6
T50	50IP	8.9	6.2
T55	55IP	11.3	8.0
T60	60IP	13.3	9.5
T70	70IP	15.6	11.1
T80	80IP	17.6	12.7
T90	90IP	20.0	14.2
T100	100IP	22.2	15.8

TORX® / TORXplus® SOCKETS

		S1 (mm)	S2 (mm)
E4	4EP	3.7	2.7
E5	5EP	4.6	3.3
E6	6EP	5.6	4.0
E7	7EP	6.1	4.3
E8	8EP	7.4	5.3
E10	10EP	9.3	6.8
E11	11EP	9.9	7.1
E12	12EP	11.0	7.9
E14	14EP	12.8	9.2
E16	16EP	14.6	10.5
E18	18EP	16.5	11.9
E20	20EP	18.3	13.2
E22	22EP	20.1	14.8
E24	24EP	22.0	15.7
E26	26EP	23.7	17.5
E28	28EP	25.5	18.3
E30	30EP	27.3	20.0
E32	32EP	29.0	21.3

TORXplus® With Hole BITS

		S1 (mm)	S2 (mm)
8IPR		2.2	2.0
9IPR		2.4	2.2
10IPR		2.6	2.4
15IPR		3.1	2.8
20IPR		3.6	3.3
25IPR		4.1	3.8
27IPR		4.7	4.3
30IPR		5.2	4.8
40IPR		6.3	5.7
45IPR		7.4	6.7
50IPR		8.4	7.6
55IPR		10.6	9.7

LHstick® (LH-S) SOCKETS

		S1 (mm)	S2 (mm)
LH3S		3.8	4.7
LH4S		4.5	6.0
LH5S		5.6	7.5
LH6S		6.8	9.0
LH7S		7.9	10.5
LH8S		9.0	12.0
LH10S		11.3	15.0
LH12S		13.6	18.0
LH14S		15.8	21.0
LH16S		18.1	24.0

XZN BITS

		S1 (mm)	S2 (mm)
M4		3.6	3.1
M5		4.8	4.1
M6		6.1	5.1
M8		7.3	6.1
M10		9.7	8.1
M12		11.5	9.7
M14		13.3	11.2
M16		15.7	13.2
M18		16.9	14.2

Ribe CV BITS

		W (mm)	S1 (mm)	S2 (mm)
M5		1.2	5.0	3.8
M6		1.3	6.0	4.5
M7		1.4	7.0	5.0
M8		1.8	8.0	6.0
M9		2.0	9.0	7.1
M10		2.3	10.0	7.4
M12		2.6	12.0	9.0
M13		3.1	13.0	11.0
M14		3.2	14.0	10.4
M16		3.6	16.0	11.9

TORX® is a registered trademark of Acument Intellectual Properties, LLC.
 TORX® es una marca registrada de Acument Intellectual Properties, LLC.
 TORXplus® is a registered trademark of Acument Intellectual Properties, LLC.
 TORXplus® es una marca registrada de Acument Intellectual Properties, LLC.
 LHstick® is a registered trademark of OSG CORPORATION System Engineering Department.
 LHstick® es una marca registrada de OSG CORPORATION System Engineering Department.

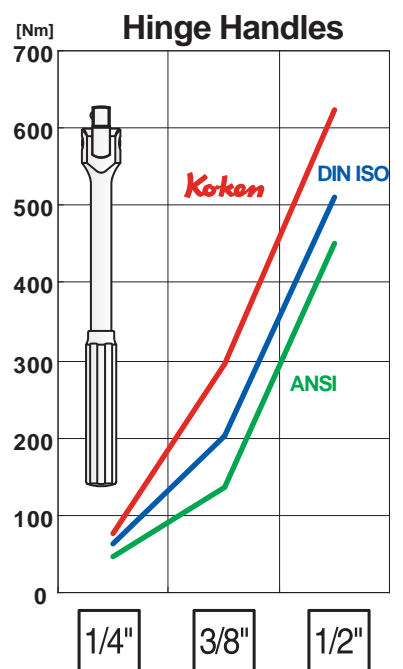
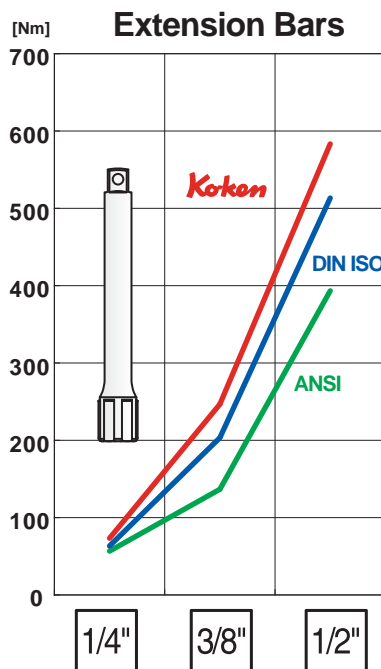
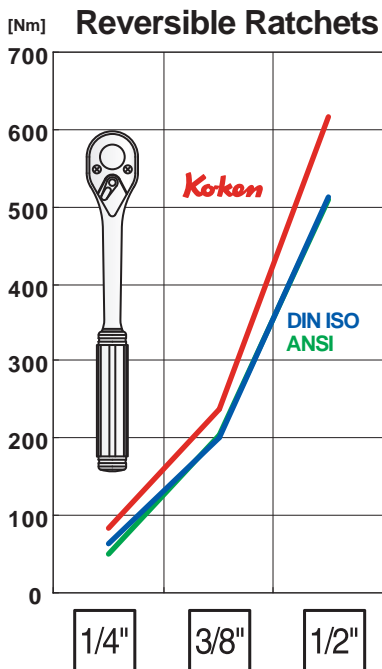
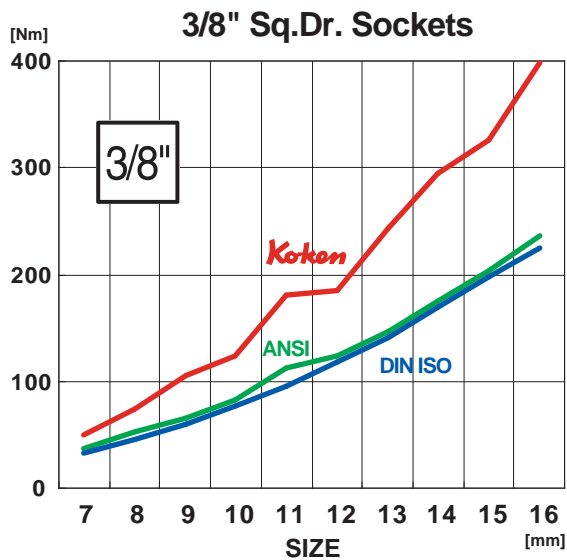
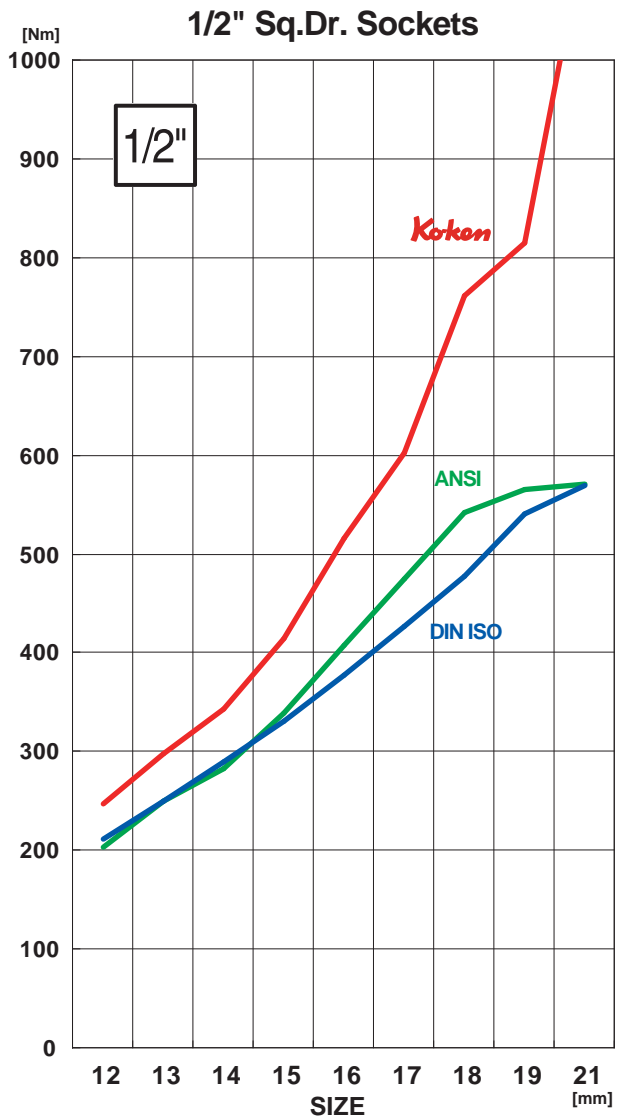
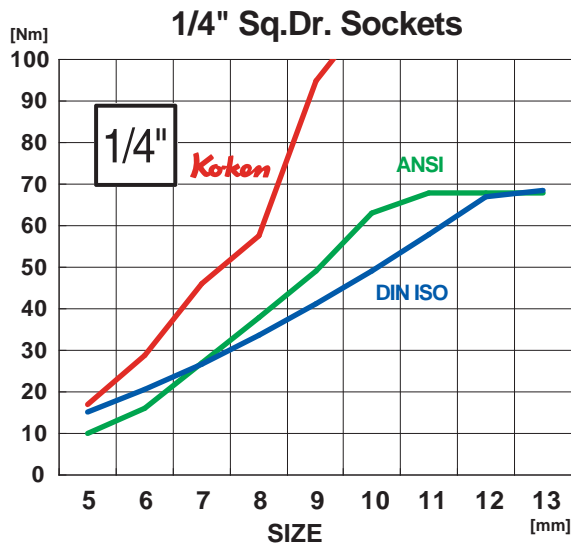

Numerical Index

10099A	246	12400A	186	13460M	192	14405M	202
100H	166	12400AG	186	13460MG	192	14406A	203
100P	166	12400M	186	13465M	191	14406M	203
100P (PZ)	166	12400MG	186	135E	176	14410M	204
100S	166	12410M	186	137	158	14415M	205
100T (T)	166	12425	187	13760	200	14425	205
100T (TH)	166	12460A	187	13760-P.FR	265	14425-EPL	205
100X (XZN)	166	12460AG	187	13770	201	14433A	216
101A	161	12460M	187	13771	201	14440A	209
101B	160	12460MG	187	13772	201, 279	14440M	209
101H	160	12465M	187	138	158	14444AL	215
101P	160	124M (2B)	151	139	158	14455A	216
101S	160	12760	188	14012M	210	14465M	205
101T (T)	160	12770	188	14025	210	14466A	216
101T (TH)	160	127C	269	141	144, 297	14466A-B	290
102KA	156	128H	161	14100A	143	14488A-B	290
102KM	156	128T	161	14100M	143	144KM	271
102KM.BH	156	13012M	196	14101M	287	145KM-10H	158
102KT	156	13025	196	14103M	145	145LH3/8F	276
102NA	156	13103M	145	14106	213	14760	215
102NM	156	13134	175, 196	14112	287	14760-P.FR	265
103KA	157	13134M	198	14113J	284	14770	215
103KA.BH	157	13134T (IP)	198	14113M	284	14771	215
103KM	157	13134T (T)	198	14118M	284	14772	215, 279
103KT	157	13134X (XZN)	198	14124	285	148KM	271
10400A	246	13137E	169	14124/3	285	150-10H	158
10400M	246	13137H	169	14134	175, 210	150-14H	276
104A	150	13139	165	14134M	212	15300M	219
104M	150, 281	13140	167	14134T (IP)	212	15310M	219
106	275	13142-D6.3	165	14134T (T)	212	15400A	218
107-16	213, 226, 236	13142-F11.2	175, 196	14134X (XZN)	212	15400M	218
107-16 (IP)	213, 226, 236	13142-F6.3	169	14137E	169	15410M	218
107-16 (T)	213, 226, 236	13145A	279	14139	165	154K	276
107-16 (XZN)	213, 226, 236	13145M	199	14140	167	154M	157
107-22	227, 237	13145M (12P)	199, 273	14142-D6.3	165	154ML	157
107-22 (T)	227, 237	13145MG	199	14142-F11.2	175, 210	155	281
107-32	242	13146M	200	14142-F6.3	169	15544A	219
108A	164	13147M	200	14145A	279	15555AL	219
108H	164	13241M	201	14145M	214	15566A	219
108P	164	13242M	201	14145PM	282	156M	150
108S	164	13300A	193	14146M	214	15770	219
108T (T)	164	13300G	195	14147M	214	157H	152, 281
108T (TH)	164	13300M	193	14184	295	157P	152, 281
110	176	13300XG	193	141P	144, 297	157S	152
112	176	13301A	194	141S	144, 297	157T (T)	152, 281
113	171	13301M	194	142	296	158	275
113 (2B)	171	13301X	193	14201M	282	160K	155
113 (E)	171	13305M	194	14207M	217	16101M	287
113UN	173	13306M	194	14208M	217	16102M	288
115	172	13310M	194	14209M	216	16106	225
115G	173	13322A	201	14210M	216	16106-16	225
115G-FR	266	13325	195	14210T	216	16106-16 (T)	225
117	176	13333AL	201	14210X	216	16106-16 (XZN)	225
120	176	13344A	201	14218M	284	16107	227
1201	144, 297	13365M	195	14241M	217	16107-22	227
1202	161	13400A	189	14242M	217	16134	175
1203	158	13400AG	189	14245M	217	16201A	229
1206	276	13400M	189	14300A	207	16201M	229
1210	277	13400M-FR	265	14300G	209	16245M	229
1210E	277	13400MG	189	14300M	207	162E	296
1212	278	13400-WN	192	14301A	207	162RK	307
12137E	169	13401A	190	14301M	207	16300A	223
12139	165	13401LH	192	14301X	206	16300M	223
12140	167	13401M	190	14305M	208, 279	16301A	223
12142-F6.3	169	13401MS	190	14306M	208	16301M	223
121H	168	13405A	189	14310M	208	16301X	222
121P	168	13405M	189	14325	209	16305M	224, 273
121T (IP)	169	13406A	190	14365M	209	16310M	224
121T (T)	168	13406M	190	14400A	202	16316A	290
121T (TH)	169	13410M	191	14400M	202	16316M	290
12222AL	188	13425	191	14400M-FR	265	16317A	290
12233A	188	13425-EPL	191	14400MG	204	16317M	290
12300G	188	13430M	195	14400-WN	206	16325	224
12300M	188	13440A	195	14401A	203	16400A	220
12365M	188	13440M	195	14401LH	206	16400M	220
123PG	170, 295	13440T	195	14401M	203	16401A	221
123PN	170, 295	13460A	192	14401MS	204	16401M	221
123PT	170	13460AG	192	14405A	202	16405A	220

16405M	220	18401A	231	23405M	259	2769H	54
16410M	221	18401M	231	23410M	259	2769N	54, 182
16425	222	18405A	231	23425	259	2769NWF	54, 182
16425-EPL	222	18405M	231	2350G	271	2770	55
165LM	170	18410M	232	2350M	44	2771	55
16644A	228	184-64	295	2350X	42	2771Z	26
16655A	228	186	176	23760-P	260	2772Z	26
16666AL	228	18760	238	2400A	40	2774J	52
16688A	228	18770	238	2400M	40	2774JS	51
166P	180	18771	238	2400MZ	23	2774JS-3/8	84
166PS/6	180	18866A	239	2400W-BA	41	2774N	52
166S	180	18877A	239	2405A	40	2774P	52
16760	227	18888AL	238	2405M	40	2774P-1/4HF	165
16770	228	19300M	245	2410M	41	2774P-5/16HF	167
16771	228	19400A	244	2415A	41	2774PS	51
167A	178	19400M	244	2415M	41	2774PS-3/8	84
167C (2B)	178	19760	245	2425	42	2780	55
167M	178	19770	245	24300A	262	2785	55
168C	181	19977A	245	24300M	262	280PM	282
168CS	181	2000 (PH)	46	24305M	262	3000 (PH)	71
168H-B	179	2000 (PZ)	46	2430M	46	3000 (PZ)	71
168P	181	2000Z	24	2430T	46	3001	79
168P (PZ)	179	2005	46	24310M	262	3005	71
168PS/6	181	2005Z	24	24400A	261	3006	79
168S	181	2010A	47	24400M	261	3010A	72
168T (250)	278	2010M	47	24405M	261	3010M	72
168T (IP)	305	2010MZ	24	2440A	45	3010MZ	30
168T (TH)	179	2011M	47	2440M	45	3011M	74
168T/7 (TH)	179	2020	47	2440T	45	3012A	73
169	278	2025 (IP)	49	24410M	261	3012M	73
169/2	278	2025 (IPR)	49	2441M	45	3012M-25	73, 275
169BP	278	2025 (T)	48	24425	261	3015M	74
169HR	278	2025 (TH)	48	2445A	45	3020	75
169HR/2	278	2025Z	25	2445M	45	3025 (IP)	78
169WM	278	2120	52	2450MS	42	3025 (IPR)	78
170S	300	2127	146	24760-P	262	3025 (T)	76
171	300	2137	165	2715	153	3025 (TH)	77
17108	242	2138	167	2725RK	305	3025-100R (T)	76
17108-32	242	2201AM	56	2725RK-3/8	305	3025-100R (TH)	77
171B-1/2	301	2203A	56	2725Z	25	3025Z	30
171S	300	2203M	56	2725Z-3/8	31	3027	79
171SB-1/2	301	22300A	258	2725Z-3/8 (L160)	31	3110A	274
172	301	22300M	258	2726Z	25	3110M	274
17300A	241	2233A	55	2726Z-3/8	31	3112G	162
17300M	241	22400M	258	2726Z-3/8 (L160)	31	3112N	162
17400A	240	22425	258	2749N-3/8	80	3112RK	306
17400M	240	2250A	56	2749P-1/4HF	165	3116M	151
17405A	241	2250M	56	2749P-3/8	80	3117M	71
17405M	241	2254M	56, 161	2749P-5/16HF	167	3119	294
17760	243	2257M	57	2749PS-3/8	80	3127	146
17770	243	2260M	57	2749RK	304	3128	147
17788A	243	2261M	57	2749RK-3/8	304	3129	148
17799A	243	2262M	57	2752N	51	3131A	155
18101M	287	2274A	57	2752RK	304	3131E	155
18102M	288	2274M	57	2753BRK	304	3132	155
18104M	232	2275	58	2753J	50	3137	165
18106	235	2276	58	2753JB	51	3138	167
18106-16	235	2277	58	2753N	50	3200A	92
18106-16 (T)	235	2277A-12P	58	2753NB	51	3200M	92
18106-16 (XZN)	235	2285ZE	27	2753P	50	3201AMW	92
18107	237	2286Z	27	2753PB	51	3206A	92
18107-22	237	2300A	43	2753PS	50	3206AM	92
18300A	233	2300M	43	2753RK	304	3206M	92
18300M	233	2300MZ	23	2755	52	3210M	93
18301A	234	2300W-BA	44	2755RK	306	3215A	93
18301M	234	2300X	42	2756	52	3215M	93
18301X	233	2300XZ	23	2756Z	26	3217M	93
18310M	234	2305A	43	2756Z-1/2	26	3220M	93
18316A	290	2305M	43	2756Z-3/8	26	3221M	93
18316M	290	2310M	44	2760	53	3225A	270
18317A	290	2325	44	2760Z	26	3240M	94
18317M	290	23300A	260	2762	52	3244	93
183H	174, 197, 211, 250	23300M	260	2763	53	3247	77, 277
183T (IP)	174, 197, 211, 250	23305M	260	2768J	53	3250M	94
183T (T)	174, 197, 211, 250	23310M	260	2768N	53	3252M	94
183X (XZN)	175, 198, 212, 251	23325	260	2768P	53	3264	155
18400A	230	23400A	259	2768RK	306	3275	95
18400M	230	23400M	259	2769F	54	3276	95

Numerical Index

3277	95	3749BRK	304	4025 (IP)	107	4325 (L140)-2B	101
3279AM	95	3749N	80	4025 (T)	106	4340C	269
3285Z	34	3749RK	304	4027	107	4400A	97
3285ZA	34	3749S	80	4100A	142	4400LH	99
3285ZE	34	3749S-1/2	110	4100ARK	307	4400M	96
3286Z	34	3749SB	80	4100M	142	4400M-DU	280
3300A	65	3749SB-1/2	110	4100MRK	307	4400MZ	35
3300C	268, 269	3749SBRK-1/2	304	4101	279	4400W	97
3300CB	268	3749SRK-1/2	304	4102	275	4405A	97
3300CZ	29	3751J	270	4103M	145	4405M	96
3300FN	67, 272	3751N	270	4104	144	4405M-DU	280
3300M	65	3752J	81	4109M	274	4405W	97
3300M (L120)	68	3752N	81	4110A	274	4410M	98
3300M/4-L120	68, 277	3752RK	305	4110M	274	4425	98
3300MZ	29	3753BRK	304	4111M	274	4425-EPL	99
3300S	268	3753J	82	4112G	162	4425-N	98, 279
3300W	66	3753JB	83	4112N	162	4433A	119
3300X	64	3753N	82	4112RK	306	4440A	102
3300XA	64	3753NB	83	4117M	102	4440M	102
3300XZ	28	3753P	82	4122	272	4440T	102
3305A	65	3753PB	83	4127	147	4445A	102
3305M	65	3753RK	304	4128	147	4445M	102
3305M (L120)	68	3753SM	82	4129	149	4450M	99
3305M/4-L120	68	3753SMB	83	4132	155	4466A	119
3305P	268, 269	3755	87	4133	272	4711X	154, 283
3305PZ	29	3755RK	306	4137	165	4715	154
3305W	66	3756	87	4138	167	4715S	154
3305X	64	3756Z	33	4202	275	4715SL	154
3305XA	64	3756Z-1/2	33	4203M	145	4725RK	305
3310M	66	3756ZS	33	4203MF	145	4725Z	35
3322A	91	3757	87	4211A	142	4747	119
3322AZ	33	3760	88	4211M	142	4749J-380	110
3325	67	3760Z	32	4214M	142	4749N	110
3340C	269	3762	87	4222M	120	4749RK	304
3340M	70	3763	88	4223M	120	4750BRK	304
3341G	271	3768J	89	4227M	120	4750J	111
3342G	271	3768N	89	4230A	120	4750JB	111
3344A	91	3768P	89	4230M	120	4750N	111
3345P	269	3768RK	306	4232M	120	4750NB	111
3350M	67	3768Z	32	4238AM	122	4750P	111
3350M (L120)	68	3768ZRK	306	4240A	121	4750PB	111
3350M/2-L120	68, 277	3769H	90	4240M	121	4750RK	304
3350X	64	3769N	90, 182	4241A	122	4752J	112
3400A	60	3769NWF	90, 182	4241M	122	4752N	112
3400LH	62	3770	90	4244A	122	4752RK	305
3400M	60	3771	90	4244M	122	4753BRK	304
3400M-24	275	3771Z	33	4248M	123	4753J	112
3400MZ	28	3772Z	33	4250M	123	4753JB	113
3400W	61	3774J	84	4251A	123	4753N	112
3405A	60	3774JB	85	4251M	123	4753NB	113
3405M	60	3774JBL	86	4252A	123	4753P	112
3405W	61	3774JL	86	4252M	123	4753PB	113
3410M	61	3774N	84	4254	123	4753RK	304
3415A	62	3774NB	85	4261M	124	4755	117
3415M	62	3774NL	86	4263M	124	4755RK	306
3425	62	3774P	84	4273AM	124	4756	117
3425 (2B)	63	3774PB	85	4275	125	4756Z	36
3430M	70	3774PL	86	4276	125	4760	118
3440A	69	3774PS	84	4277	125	4760Z	35
3440M	69	3774P-SR	85	4279AM	125	4763	118
3440T	69	3776J	81	4282	276	4768J	116
3441M	70	3776N	81	4285Z	36	4768N	116
3445A	69	3776P	81	4285ZE	36	4768P	116
3445M	69	3780	91	4289M	125	4768RK	306
3445W	69	3785	91	4300A	100	4768Z	35
3450M	63	4000 (PH)	103	4300C	268	4768ZRK	306
3450MH	63	4000 (PZ)	103	4300H	273	4770	117
3701	270	4001	103	4300H (8P)	273	4771	117
3715	153	4005	103	4300M	100	4771Z	36
3715S	153	4006	103	4300M (L110)	283	4772Z	36
3715SL	153	4010A	104	4300M (L120)	100	4774J	114
3715SLK	153	4010M	104	4300M (L60)	283	4774JB	115
3716	153	4010M (12P)	273	4300S	268	4774N	114
3725RK	305	4012A	109	4305A	100	4774NB	115
3725Z	31	4012M	108	4305M	100	4774P	114
3725ZS	31	4012M-43	108, 280	4310M	101	4774PB	115
3726Z	32	4020	105	4325	101	4780	118
3726ZS	32	4020-60 (MH)	274	4325 (L140)	101	4781N	117

4785	119	BD011SE	293	RS14301X/10	206	RS3350X/4	64
4788	119	BD013E	294	RS14401M/10	203	RS3400A/9	60
6012M	127	BD014E	292	RS14401MS/10	204	RS3400LH/7	62
6100M	143	BD014E-SF	293	RS2010A/8	47	RS3400M/12	60
6100MRK	307	BD014SE	292	RS2010M/7	47	RS3400M/8	60
6101	279	BD014XE-SF	293	RS2025/7	48	RS3400MZ/12	28
6102M	288	BD016E	298	RS2025/7-HOLE	48	RS3400MZ/8	28
6112	162	BD016JE	298	RS2025/7-IP	49	RS3400W/7	61
6112RK	306	BD017E	294	RS2025/7-IPR	49	RS3405A/9	60
6201A	132	BD018	294	RS2025Z/7	25	RS3405M/12	60
6201M	132	BD022	176	RS20XXZ/9	24	RS3405M/8	60
6212A	132	BD023E	295	RS2127/10	146	RS3405W/7	61
6212M	132	BD024E	295	RS2127/6	146	RS3410M/12	61
6260A	133	BD030W-1/2	295	RS2300A/9	43	RS3425/4 (2B)	63
6260M	133	BD14400MJ	298	RS2300M/12	43	RS3425/9	62
6268M	133	CLIP.P/5	34	RS2300MZ/12	23	RS3430M/6	70
6300A	127	D3753J	82	RS2300X/12	42	RS3440A/8	69
6300M	127	D4753J	112	RS2300XZ/9	23	RS3440M/8	69
6305A	127	HA001	299	RS2305A/9	43	RS3440T/8	69
6305M	127	HA002	299	RS2305M/12	43	RS3441M/5	70
6400A	126	HA003	299	RS2310M/12	44	RS3445W/7	69
6400M	126	HA004	299	RS2350M/4	44	RS3450M/10	63
6405A	126	KP14101	286	RS2350X/4	42	RS3450M/8	63
6405A-MV	280	KP14101/6H	286	RS2400A/9	40	RS3450MH/6	63
6405M	126	KP14101/6S	286	RS2400M/12	40	RS3X00MZ/12	29
6425	126	NV13134	251	RS2400MZ/12	23	RS4010A/10	104
6644A	131	NV13145	249	RS2400W/9-BA	41	RS4010M/10	104
6688A	131	NV13400	249	RS2405A/9	40	RS4012A/10	109
6749	128	NV13760	249	RS2405M/12	40	RS4012M/10	108
6749RK	304	NV14134	251	RS2410M/12	41	RS4020/6	105
6752	128	NV14145	252	RS2425/6	42	RS4025/9	106
6752RK	305	NV14400	252	RS2445A/9	45	RS4025/9-IP	107
6755	129	NV14433A	252	RS2450MS/6	42	RS4027/6	107
6755RK	306	NV14760	252	RS3010A/8	72	RS4127/6	147
6760	129	NV16400	253	RS3010M/8	72	RS4129/5	149
6768	130	NV16760	253	RS3010MZ/8	30	RS4300A/10	100
6768RK	306	P2201AM	59	RS3012A/8	73	RS4300M/10	100
6770	131	P2251M	59	RS3012M/8	73	RS4305A/10	100
6785	130	P2258M	59	RS3015M/8	74	RS4305M/10	100
6788	130	P2281A-12P	59	RS3020/6	75	RS4310M/10	101
8012M	135	P2285Z	27	RS3020/7	75	RS4325/7	101
8102M	288	P3262M-6P	94	RS3025/8	76	RS4400A/10	97
8200A	138	P4241M	124	RS3025/8-IP	78	RS4400LH/6	96
8200M	138	PK166PS/6	180	RS3025/8-L100R	76	RS4400M/10	99
8225M	138	PK168PS/6	181	RS3025/8-L100RH	77	RS4400MZ/10	35
8400A	134	PK2346/6	91	RS3025/9-HOLE	77	RS4400W/8	97
8400M	134	PK2760/6	53	RS3025/9-IPR	78	RS4405A/10	97
8405A	134	PK2763/6	53	RS3025Z/8	30	RS4405M/10	96
8405M	134	PK3760/6	88	RS3027/5	79	RS4405W/8	97
8749	136	PK3763/6	88	RS3127/8	146	RS4410M/10	98
8749RK	304	PK4760/5	118	RS3129/6	148	RS4425/6-EPL	99
8760	135	PK4763/5	118	RS3300A/9	65	RS4425/6-N	98, 279
8768	136	PS6	289	RS3300FN/6	67, 272	RS4425/7	98
8768RK	306	PS8	289	RS3300M/12	65	RS4450M/10	99
8770	135	PW6	289	RS3300M/8	65	RSAL	34
8785	136	PW8	289	RS3300MZ/12	29	RSAS2305A/10	43
8788	136	PW8L	289	RS3300MZ/8	29	RSAS2405A/10	40
8866A	135	PW8P	289	RS3300W/7	66	RSX025/11-IP	78
AG112A	163	PW8P/4	289	RS3300X/8	64	RSX025/11-IPR	78
AG112F	163	R810	157	RS3300XA/9	64	S14240M	217
AG112H	163	R810A	159	RS3300XZ/12	28	S3240A	94
AG318A	163	R810B	159	RS3300XZ/8	28	S3240M	94
AN112A	163	R810C	159	RS3305A/9	65	S4240A	121
AN112C	163	R810D	159	RS3305M/12	65	S4240M	121
AN14300	284	R810E	159	RS3305M/8	65	SP4122	272
AN318A	163	RS13025/8	196	RS3305W/7	66	SP4300M	272
AS2305A	43	RS13301X/9	193	RS3305X/8	64	SP4305M	272
AS2405A	40	RS13401M/9	190	RS3305XA/9	64	ST4027	273
AS2445A	45	RS13401MS/5	190	RS3310M/12	66	TI4261M	140
BD003E-I	294	RS14012M/10	210	RS3325/9	67		
BD004	296	RS14025/6	210	RS3340M/8	70		
BD008E	292	RS14124/7	285	RS3350M/5	67		

Reproduction in whole or in part without proper and prior authorization is prohibited.
Prohibida la reproducción total o parcial sin la debida autorización previa.

本商品目錄之全部版權,係歸於株式會社山下工業研究所(Koken TOOL CO.,LTD.)所有,不論其部分或全部,未經本公司許可,均不得複製

